

Pioneer *sound.vision.soul*

DVD Player

DV-454

DV-350

DVD
VIDEO

COMPACT
disc
DIGITAL AUDIO

COMPACT
disc
DIGITAL VIDEO

Operating Instructions

IMPORTANT



The lightning flash with arrowhead symbol, within an equilateral triangle, is intended to alert the user to the presence of uninsulated "dangerous voltage" within the product's enclosure that may be of sufficient magnitude to constitute a risk of electric shock to persons.



CAUTION:
TO PREVENT THE RISK OF ELECTRIC SHOCK, DO NOT REMOVE COVER (OR BACK). NO USER-SERVICEABLE PARTS INSIDE. REFER SERVICING TO QUALIFIED SERVICE PERSONNEL.



The exclamation point within an equilateral triangle is intended to alert the user to the presence of important operating and maintenance (servicing) instructions in the literature accompanying the appliance.

H002_En

Replacement and mounting of an AC plug on the power supply cord of this unit should be performed only by qualified service personnel.

IMPORTANT

FOR USE IN THE UNITED KINGDOM

The wires in this mains lead are coloured in accordance with the following code :

Blue : Neutral
Brown : Live

If the plug provided is unsuitable for your socket outlets, the plug must be cut off and a suitable plug fitted.

The cut-off plug should be disposed of and must not be inserted into any 13 amp socket as this can result in electric shock. The plug or adaptor or the distribution panel should be provided with 5 A fuse. As the colours of the wires in the mains lead of this appliance may not correspond with coloured markings identifying the terminals in your plug, proceed as follows ;

The wire which is coloured blue must be connected to the terminal which is marked with the letter N or coloured black.

The wire which is coloured brown must be connected to the terminal which is marked with the letter L or coloured red.

Do not connect either wire to the earth terminal of a three pin plug.

NOTE

After replacing or changing a fuse, the fuse cover in the plug must be replaced with a fuse cover which corresponds to the colour of the insert in the base of the plug or the word that is embossed on the base of the plug, and the appliance must not be used without a fuse cover. If lost replacement fuse covers can be obtained from: your dealer.

Only 5 A fuses approved by B.S.I. or A.S.T.A to B.S. 1362 should be used.

H005B_En

CAUTION

This product contains a laser diode of higher class than 1. To ensure continued safety, do not remove any covers or attempt to gain access to the inside of the product.

Refer all servicing to qualified personnel.

The following caution label appears on your unit.

Location: rear of the unit



H018A_En

This product complies with the Low Voltage Directive (73/23/EEC, amended by 93/68/EEC), EMC Directives (89/336/EEC, amended by 92/31/EEC and 93/68/EEC).

H015A_En

CAUTION: THE STANDBY/ON BUTTON IS SECONDARY CONNECTED AND THEREFORE DOES NOT SEPARATE THE UNIT FROM MAINS POWER IN STANDBY POSITION. THEREFORE INSTALL THE UNIT SUITABLE PLACES EASY TO DISCONNECT THE MAINS PLUG IN CASE OF THE ACCIDENT. THE MAINS PLUG OF UNIT SHOULD BE UNPLUGGED FROM THE WALL SOCKET WHEN LEFT UNUSED FOR A LONG PERIOD OF TIME.

H017B_En

WARNING: THE APPARATUS IS NOT WATER-PROOFS, TO PREVENT FIRE OR SHOCK HAZARD, DO NOT EXPOSE THIS APPARATUS TO RAIN OR MOISTURE AND DO NOT PUT ANY WATER SOURCE NEAR THIS APPARATUS, SUCH AS VASE, FLOWER POT, COSMETICS CONTAINER AND MEDICINE BOTTLE ETC.

H001A_En

On the top of the player

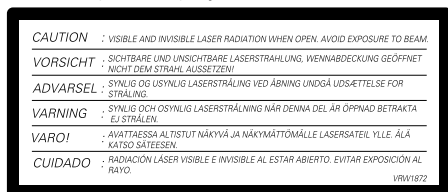

WARNING: BEFORE PLUGGING IN THE UNIT FOR THE FIRST TIME, READ THE FOLLOWING SECTION CAREFULLY. THE VOLTAGE OF THE AVAILABLE POWER SUPPLY DIFFERS ACCORDING TO COUNTRY OR REGION. BE SURE THAT THE POWER SUPPLY VOLTAGE OF THE AREA WHERE THIS UNIT WILL BE USED MEETS THE REQUIRED VOLTAGE (E.G., 230V OR 120V) WRITTEN ON THE REAR PANEL.

H041A_En

WARNING: NO NAKED FLAME SOURCES, SUCH AS LIGHTED CANDLE, SHOULD BE PLACED ON THE APPARATUS. IF NAKED FLAME SOURCES ACCIDENTALLY FALL DOWN, FIRE SPREAD OVER THE APPARATUS THEN MAY CAUSE FIRE.

H044_En

OPERATING ENVIRONMENT

Operating environment temperature and humidity:

+5°C – +35°C (+41°F – +95°F); less than 85%RH (cooling vents not blocked)

Do not install in the following locations

- LOCATION EXPOSED TO DIRECT SUNLIGHT OR STRONG ARTIFICIAL LIGHT
- LOCATION EXPOSED TO HIGH HUMIDITY, OR POORLY VENTILATED LOCATION

H045_En

WARNING: Slot and openings in the cabinet are provided for ventilation and to ensure reliable operation of the product and to protect it from overheating, to prevent fire hazard, the openings should never be blocked and covered with items, such as newspapers, table-cloths, curtains, etc. Also do not put the apparatus on the thick carpet, bed, sofa, or fabric having a thick pile.

H040_En

When disposing of used batteries, please comply with governmental regulations or environmental public instruction's rules that apply in your country or area.

K048_En

This product is for general household purposes. Any failure due to use for other than household purposes (such as long-term use for business purposes in a restaurant or use in a car or ship) and which requires repair will be charged for even during the warranty period.

K041_En

This product incorporates copyright protection technology that is protected by method claims of certain U.S. patents and other intellectual property rights owned by Macrovision Corporation and other rights owners. Use of this copyright protection technology must be authorized by Macrovision Corporation, and is intended for home and other limited viewing uses only unless otherwise authorized by Macrovision Corporation. Reverse engineering or disassembly is prohibited.

This product includes FontAvenue® fonts licenced by NEC corporation. FontAvenue is a registered trademark of NEC Corporation.

Thank you for buying this Pioneer product.

Please read through these operating instructions so you will know how to operate your model properly. *After you have finished reading the instructions, put them away in a safe place for future reference.*

01 Before You Start

Features	6
What's in the box	7
Putting the batteries in the remote control	7
Using the remote control	7
Disc / Content Format Playback	
Compatibility	8
General Disc Compatibility	8
CD-R/RW Compatibility	8
DVD-R/RW Compatibility	8
PC Created Disc Compatibility	8
Compressed Audio Compatibility	9
Titles, chapters and tracks	9
DVD-Video regions	9

02 Connecting Up

Rear panel connections	10
Easy connections	11
Connecting using the S-Video output	12
Connecting using the AV connector output	12
Connecting to an AV receiver	13

03 Controls and Displays

Front panel	15
Display	16
Remote control	17

04 Getting Started

Switching on	19
Let's Get Started	19

Using the on-screen displays	20
Setting up with the Setup Navigator	21
Playing discs	23
Basic playback controls	24
Front panel controls	25
DVD-Video disc menus	25
Video CD PBC menus	26

05 Playing Discs

Introduction	27
Using the Disc Navigator to browse the contents of a disc	27
Scanning discs	28
Playing in slow motion	28
Frame advance/frame reverse	28
Looping a section of a disc	29
Using repeat play	29
Using random play	30
Creating a program list	31
Editing a program list	33
Other functions available from the program menu	33
Searching a disc	34
Switching subtitles	34
Switching DVD audio language	34
Switching audio channel when playing a Video CD	35
Zooming the screen	35
Switching camera angles	35
Displaying disc information	36

Contents

06 The Audio Settings Menu

Audio DRC	37
Virtual Surround	37

07 The Initial Settings Menu

Using the Initial Settings menu	39
Digital Audio Out settings	39
Digital Out	39
Dolby Digital Out	39
DTS Out	40
96kHz PCM Out	40
MPEG Out	40
Video Output settings	41
TV Screen	41
AV Connector Out	41
S-Video Out	41
Language settings	42
Audio Language	42
Subtitle Language	42
DVD Menu Language	43
Subtitle Display	43
Display settings	43
OSD Language	43
On Screen Display	43
Angle Indicator	44
Options	44
Parental Lock	44
Registering a new password	44
Changing your password	45
Setting/changing the Parental Lock level	45
Setting/changing the Country Code ...	46

08 Additional Information

Taking care of your player and discs	47
Handling discs	47
Storing discs	47
Discs to avoid	47
Cleaning the pickup lens	48
Problems with condensation	48
Hints on installation	48
Moving the player	48
Power cord caution	48
Screen sizes and disc formats	49
Widescreen TV users	49
Standard TV users	49
Resetting the player	49
Language code list	50
Country code list	50
Selecting languages using the language code list	51
Glossary	51
Setting the TV system	53
Watching NTSC on a PAL TV (MOD. PAL)	53
Specifications	54

Features

24-bit/192kHz compatible DAC

This player is fully compatible with high sampling-rate discs, capable of delivering better-than-CD sound quality in terms of dynamic range, low-level resolution and high-frequency detail.

Excellent audio performance with Dolby*¹ Digital and DTS*² software

Logos: 



When connected to a suitable AV amplifier or receiver, this player gives great surround sound with Dolby Digital and DTS discs.

TruSurround*³ and Virtual Dolby Digital

Logo: 

TruSurround/Virtual Dolby Digital creates a realistic surround-sound effect from any Dolby Digital source using just two speakers (see [page 37](#)).

Picture zoom

While a DVD or Video CD is playing, you can zoom in on any part of the picture at up to 4x magnification for a closer look (see [page 35](#)).

MP3 compatibility

This player is compatible with CD-R, CD-RW and CD-ROM discs that contain MP3 audio tracks (see *Compressed Audio Compatibility* on [page 9](#)).

Graphical on-screen displays

Setting up and using your DVD player is made very easy using the graphical on-screen displays.

Energy saving design

This player features an auto power-off function. If the player is not used for over 30 minutes, it automatically switches itself into standby.

This unit is designed to use 0.3 W of power when in standby mode.

**1 Manufactured under license from Dolby Laboratories. "Dolby" and the double-D symbol are trademarks of Dolby Laboratories.*

**2 "DTS" is a registered trademark of Digital Theater Systems, Inc.*

**3 TruSurround and the  symbol are trademarks of SRS Labs, Inc. TruSurround technology is incorporated under license from SRS Labs, Inc.*

What's in the box

Please confirm that the following accessories are in the box when you open it.

- Remote control
- AA/R6P dry cell batteries x2
- Audio/video cable (red/white/yellow plugs)
- Power cable
- These operating instructions
- Warranty card

Putting the batteries in the remote control

1 Open the battery compartment cover on the back of the remote control.

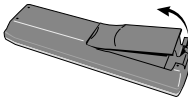

2 Insert two AA/R6P batteries into the battery compartment following the indications (+, -) inside the compartment.

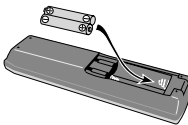

3 Close the cover.

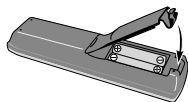

Note

Incorrect use of batteries can result in hazards such as leakage and bursting. Please observe the following:

- Don't mix new and old batteries together.
- Don't use different kinds of battery together—although they may look similar, different batteries may have different voltages.
- Make sure that the plus and minus ends of each battery match the indications in the battery compartment.
- Remove batteries from equipment that isn't going to be used for a month or more.
- When disposing of used batteries, please comply with governmental regulations or environmental public instruction's rules that apply in your country or area.

H048 En

Using the remote control

Keep in mind the following when using the remote control:

- Make sure that there are no obstacles between the remote and the remote sensor on the unit.
- The remote has a range of about 7 meters.
- Remote operation may become unreliable if strong sunlight or fluorescent light is shining on the unit's remote sensor.
- Remote controllers for different devices can interfere with each other. Avoid using remotes for other equipment located close to this unit.
- Replace the batteries when you notice a fall off in the operating range of the remote.

Disc / Content Format Playback Compatibility

General Disc Compatibility

- This player was designed and engineered to be compatible with software containing one or more of the following logos.



DVD-Video



Audio CD



Video CD



CD-R



CD-RW

- Other formats, including but not limited to the following, are not playable in this player:

DVD-Audio / SACD / Photo CD / DVD-RAM / DVD-ROM / CD-ROM

(except those that contain MP3 files formatted as specified in the “Compressed Audio Compatibility” section.)

- DVD-R/RW and CD-R/RW discs (Audio CDs and Video CDs) recorded using a DVD Recorder, CD Recorder or Personal Computer may not be playable on this machine. This may be caused by a number of possibilities, including but not limited to: the type of disc used; the type of recording; or damage, dirt or condensation on either the disc or the player’s pick-up lens.

Special note about particular formats or software follows below:

CD-R/RW Compatibility

- This unit will play CD-R and CD-RW discs recorded in CD Audio, Video CD, or MP3 audio formatting. However, any other content may cause the disc not to play, or create noise/distortion in the output.
- This unit cannot record CD-R or CD-RW discs.
- Un-finalized CD-R/RW discs recorded in CD Audio can be played, but not all Table of Contents (playing time, etc..) will be displayed.

DVD-R/RW Compatibility

- This unit will play DVD-R/RW discs that were recorded using the DVD Video format.
- This unit will not play DVD-RW discs that were recorded using the Video Recording format.
- This unit cannot record DVD-R/RW discs
- Un-finalized DVD-R/RW discs cannot be played in this player.

PC Created Disc Compatibility

- If you record a disc using a Personal Computer, even if it is recorded in a “compatible format” as listed above, there will be cases in which the disc may not be playable in this machine due to the setting of the application software used to create the disc. In these particular incidences, check with the software publisher for more detailed information.
- DVD-R/RW and CD-R/RW software disc boxes also have additional compatibility information.

Compressed Audio Compatibility

- This unit will play compressed audio files formatted in the MPEG-1 Audio Layer 3 format (MP3) with a 32, 44.1 or 48kHz fixed bit rate. Incompatible files will not play and "UNPLAYABLE" will be displayed on the unit.
- Variable Bit-Rate (VBR) files are playable, but playing time may not be shown correctly.
- The CD-ROM used to compile your MP3 files must be ISO 9660 Level 2 compliant.
- CD physical format: Mode1, Mode2 XA Form1.
- This player only plays tracks that are named with the file extension ".mp3" or ".MP3"
- This player is not compatible with multi-session discs. If you try and play a multi-session disc, only the first session will be played.
- Use CD-R or CD-RW media for recording your MP3 files. The disc must be finalized in order to play in this unit.
- This player can recognize a maximum of 250 folders or 250 tracks. Discs containing more than 250 folders or 250 tracks will play, but only the first 250 folders / tracks.
- Folder and track names (excluding the ".mp3" extension) are displayed.
- There are many different recording bit-rates available to encode your MP3 files. This unit was designed to be compatible with all of them. Audio encoded at 128Kbps should sound close to regular CD Audio quality. This player will play lower bit-rate MP3 tracks, but please note that the sound quality becomes noticeably worse at lower bit-rates.

Titles, chapters and tracks

DVD discs are generally divided into one or more titles. Titles may be further subdivided into chapters.

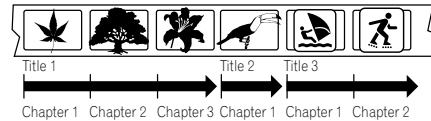

CDs and Video CDs are divided into tracks.

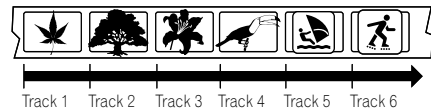

CD-ROMs containing MP3 files are divided into folders and tracks. Folders may also contain further subfolders.

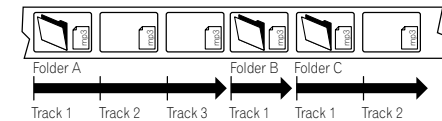

DVD-Video regions

All DVD-Video discs carry a region mark on the case somewhere that indicates which region(s) of the world the disc is compatible with. Your DVD player also has a region mark, which you can find on the rear panel. Discs from incompatible regions will not play in this player. Discs marked **ALL** will play in any player.

The diagram below shows the various DVD regions of the world.

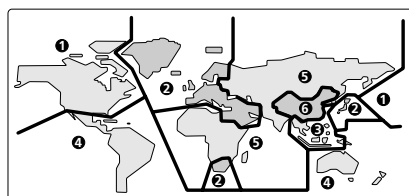

Rear panel connections

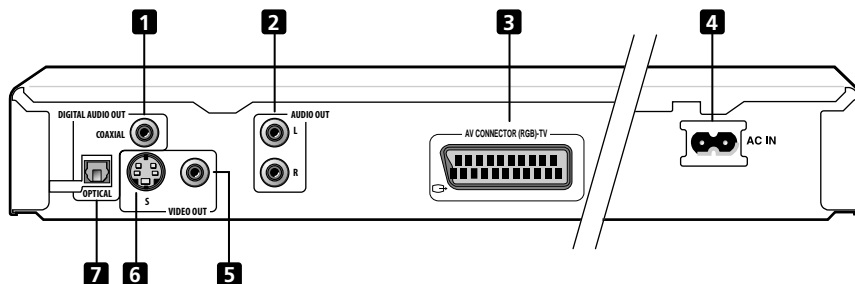

When connecting this player up to your TV, AV receiver or other components, make sure that all components are switched off and unplugged.

1 DIGITAL AUDIO OUT – COAXIAL

This is a digital audio output for connection to a PCM, Dolby Digital, DTS and/or MPEG-compatible AV receiver that has a coaxial digital input.

Connect using a commercially available coaxial digital audio cable.

2 AUDIO OUT L / R

This pair of analog audio outputs connects to your TV, AV receiver or stereo system. Even if you are connecting up one of the digital outputs, we still recommend you connect these jacks.

Use the supplied audio/video cable when connecting these jacks. Match the colors of the jacks and cables for correct stereo sound.

3 AV CONNECTOR (RGB) - TV

This is a combined audio and video output for connection to a TV that has a SCART input. Connect using a SCART cable. The type of video output can be switched to suit your TV. See **page 12** and **41**.

4 AC IN

Connect the supplied power cord here, then plug into a power outlet.

5 VIDEO OUT

This is a standard video output that you can connect to your TV or AV receiver using the supplied audio/video cable.

6 S (S-Video output)

This is an S-video output that you can use instead of the video output described in **5** above.

7 DIGITAL AUDIO OUT – OPTICAL

(DV-454 only)

This is a digital audio output for connection to a PCM, Dolby Digital, DTS and/or MPEG-compatible AV receiver that has an optical digital input.

Connect using a commercially available optical digital audio cable.



Tip

- You may find it useful to have the manuals supplied with your other components handy when connecting this player.
- If you come across any unfamiliar terms in this section of the manual, take a look at the Glossary starting on **page 51**.

Easy connections

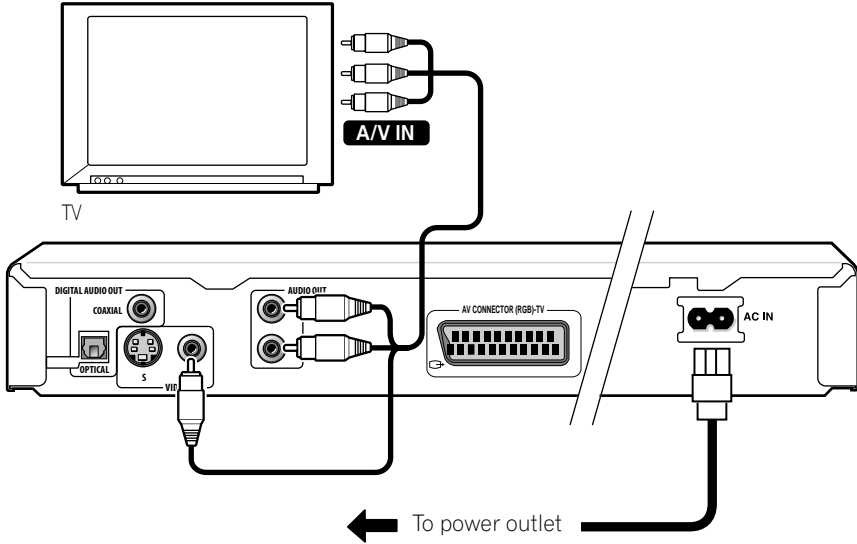

The setup described here is a basic setup that allows you to play discs using just the cables supplied with the player. In this setup, stereo audio is played through the speakers in your TV.

Important

- This player is equipped with copy protection technology. Do not connect this player to your TV via a VCR (or your VCR via this player) using AV cables, as the picture from this player will not appear properly on your TV. (This player may also not be compatible with some combination TV/VCRs for the same reason; refer to the manufacturer for more information.)

1 Connect the VIDEO OUT and AUDIO OUT jacks to a set of A/V inputs on your TV.

Use the supplied audio/video cable, connecting the red and white plugs to the audio outputs and the yellow plug to the video output. Make sure you match up the left and right audio outputs with their corresponding inputs for correct stereo sound.

See below if you want to use a SCART cable for the audio/video connection, or an S-Video cable for the video connection.

2 Connect the supplied AC power cord to the AC IN inlet, then plug into a power outlet.



Important

- Before unplugging the player from the power outlet, make sure you first switch it into standby using either the front panel **STANDBY/ON** button, or the remote control, and wait of the **-OFF-** message to disappear from the player's display.
- For the above reasons, do not plug this player into a switched power supply found on some amplifiers and AV receivers.

Connecting using the S-Video output

If your TV has an S-Video input, you can use this instead of the standard (composite) output for a better quality picture.

- 1 Use an S-Video cable (not supplied) to connect the S-VIDEO OUT to an S-Video input on your TV (or monitor or AV receiver).

Line up the small triangle above the jack with the same mark on the plug before plugging in.

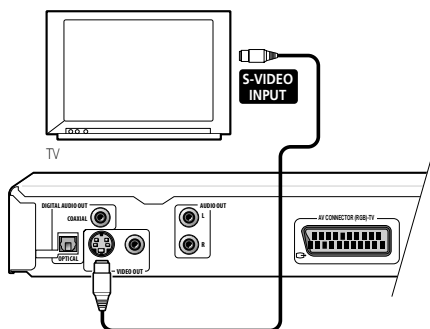

Connecting using the AV connector output

If your TV has a SCART-type AV input, you can use a SCART cable to connect this player to your TV. This type of connection carries both the sound and the picture, so there's no need to connect up the **AUDIO OUT L/R** and **VIDEO OUT** jacks.

- 1 Use a SCART cable (not supplied) to connect the AV CONNECTOR (RGB)-TV to an AV input on your TV.

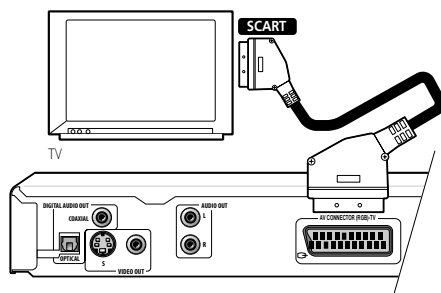

This connector can output standard (composite), S-Video or RGB component video. The default setting is standard, which should work with all TVs. Consult the manual that came with your TV to see if you can use one of the higher quality settings. See **page 41** for how to change the video output.



Note

- SCART cables are available in several configurations. Make sure that the one you get will work with this player and your TV/monitor. You can find the pin assignments on **page 54**.

Connecting to an AV receiver

To enjoy multichannel surround sound you need to connect this player to an AV receiver using a digital output. The DV-454 has both coaxial and optical digital jacks; use whichever is convenient. The DV-350 has only a coaxial jack.

In addition to a digital connection, we recommend also connecting using the stereo analog connection.

You'll probably also want to connect a video output to your AV receiver. You can use any of the video outputs available on this player (the illustration shows a standard (composite) connection).

1 Connect one of DIGITAL OUT jacks on this player to a digital input on your AV receiver.

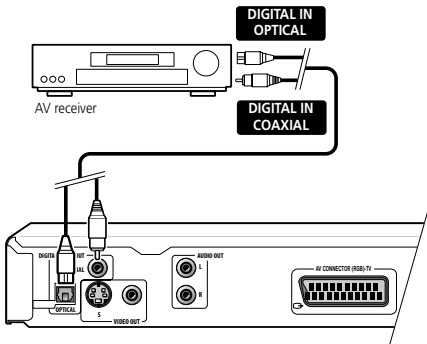

This enables you to listen to multichannel surround sound.

For an optical connection, use an optical cable (not supplied) to connect the **OPTICAL DIGITAL OUT** jack to an optical input on your AV receiver.

For a coaxial connection, use a coaxial cable (similar to the supplied video cable) to connect the **COAXIAL DIGITAL OUT** jack to a coaxial input on your AV receiver.

2 Connect the analog AUDIO OUT L/R and VIDEO OUT jacks on this player to a set of analog audio and video inputs on your AV receiver.

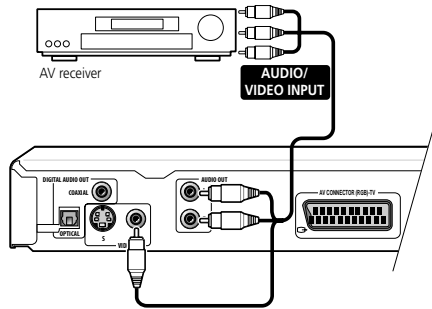

The diagram shows standard video connections, but you can alternatively use the S-Video or SCART cable connections if they're available.

3 Connect the AV receiver's video output to a video input on your TV.



Tip

- You usually have to connect the same kind of video cable between your DVD player and AV receiver, and between your AV receiver and TV.



FAQ

- *My TV doesn't have any inputs to connect the DVD player. How can I watch DVDs?*

Unfortunately, if your TV has no inputs you can't use this player with it.

- *My VCR is already connected to my TV, so there aren't any spare inputs. What should I do?*

If all your TV's inputs are already in use, you can buy a video input selector from an electronics store, which effectively gives you more inputs.

- *My TV only has one input for the sound. What should I plug it into?*

If you don't mind mono sound, you can buy a stereo RCA-to-mono RCA cable from an electronics store. Connect the stereo end to this player and the mono end to your TV.

If you want stereo sound, connect this player to your amplifier or stereo system using a stereo audio cable.

- *I connected the DVD player to my AV receiver, and although the sound is fine, there's no picture. What did I do wrong?*

Make sure that the type of video connection from the DVD player to your AV receiver is the same as that from the receiver to your TV. Most AV receivers won't convert from one kind of connection to another.

Front panel

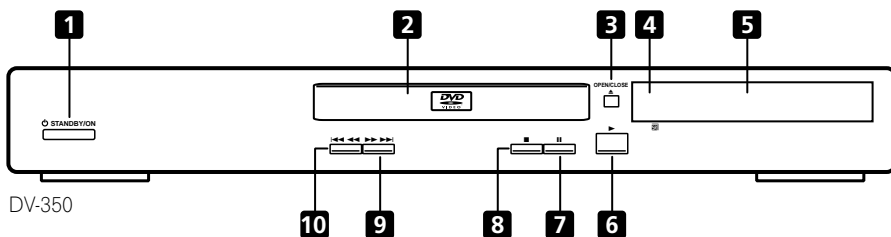

DV-350

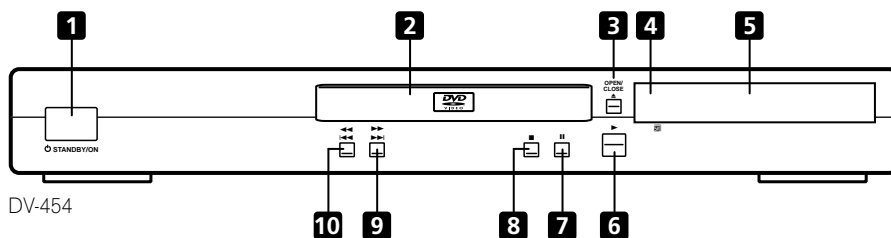

DV-454

1 **STANDBY/ON**

Press to switch the player on or into standby

2 **Disc tray**

3 **OPEN/CLOSE**

Press to open or close the disc tray

4 **Remote control sensor**

The remote control has a range of up to about 7m

5 **Display**

See **page 16** for a description of the display

6

Press to start or resume playback

7

Press to pause playback. Press again to restart

8

Press to stop the disc (you can resume playback by pressing (play))

9

- Press and hold for fast forward scanning
- Press to jump to the next chapter or track

10

- Press and hold for fast reverse scanning
- Press to jump back to the beginning of the current chapter or track, then to previous chapters/tracks

Display

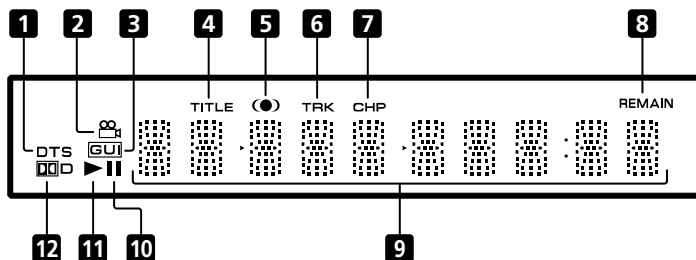

1 DTS

Lights when a DTS soundtrack is playing

2

Lights during multi-angle scenes on a DVD disc

3 GUI (Graphical User Interface)

Lights when a menu is displayed on-screen

4 TITLE

Indicates that the character display is showing a DVD title number

5

Lights when DD/TruSurround is selected

6 TRK

Indicates that the character display is showing a CD or Video CD track number

7 CHP

Indicates that the character display is showing a DVD chapter number

8 REMAIN

Lights when the character display is showing the time or number of tracks/titles/chapters remaining

9 Character display

10 II

Lights when a disc is paused

11 ▶

Lights when a disc is playing

12 DD

Lights when a Dolby Digital soundtrack is playing

Remote control

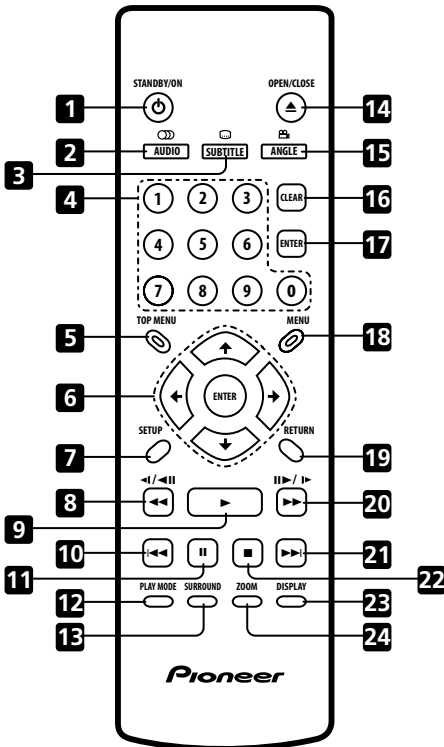

1 STANDBY/ON

Press to switch the player on or into standby

2 AUDIO

Press to select the audio channel or language (**pages 34–35**)

3 SUBTITLE

Press to select a subtitle display (**page 34**)

4 Number buttons

5 TOP MENU

Press to display the top menu of a DVD disc

6 ENTER & cursor control buttons

Use to navigate on-screen displays and menus. Press **ENTER** to select an option or execute a command

7 SETUP

Press to display (or exit) the on-screen display

8 and

Use for reverse slow motion playback, frame reverse and reverse scanning. See **page 28**

9

Press to start or resume playback

10

Press to jump to the beginning of the current chapter or track, then to previous chapters/tracks

11

Press to pause playback; press again to restart

12 PLAY MODE

Press to display the Play Mode menu (**pages 29–34**) (You can also get to the Play Mode menu by pressing **SETUP** and selecting **Play Mode**)

13 SURROUND

Press to activate/switch off V/TruSurround

14 ▲ OPEN/CLOSE

Press to open or close the disc tray

15 ANGLE

Press to change the camera angle during DVD multi-angle scene playback (**page 35**)

16 CLEAR

Press to clear a numeric entry

17 ENTER

Use to select menu options, etc. (works exactly the same as the **ENTER** button in 6 above)

18 MENU

Press to display a DVD disc menu, or the Disc Navigator if a CD, Video CD or MP3 disc is loaded

19 RETURN

Press to return to a previous menu screen

20 ►► and II►/►

Use for forward slow motion playback, frame advance and forward scanning. (**page 28**)

21 ►►

Press to jump to the next chapter or track

22 ■

Press to stop the disc (you can resume playback by pressing ► (play))

23 DISPLAY

Press to display information about the disc playing (**page 36**)

24 ZOOM

Press to change the zoom level (**page 35**)

Switching on

After making sure that everything is connected properly and that the player is plugged in, press **⏻ STANDBY/ON** on the front panel, or on the remote control to switch the player on.

Also, switch on your TV and make sure that it is set to the input you connected the DVD player to.

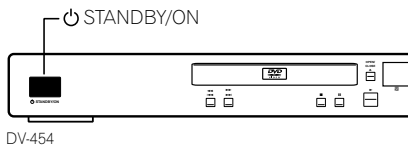

FAQ

- *My DVD player switches on but there is nothing displayed on my TV.*

Make sure that the TV is set to the correct video input (not a TV channel). For example, if you connected this player to the **VIDEO 1** inputs on your TV, switch your TV to **VIDEO 1**.



Note

- This player features a screen saver and an auto power off function. If the player is stopped and no button is pressed for five minutes, the screen saver starts. If the disc tray is closed but no disc is playing and no control is pressed for 30 minutes, the player automatically goes into standby.

Let's Get Started

When you switch on the player for the first time, you should see a welcome screen displayed on your TV. From here you can set up the language and the kind of TV you have, then either use the Setup Navigator to make more settings, or jump right in and start playing some discs.

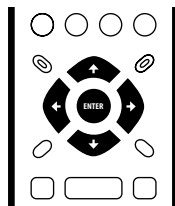

- 1 Use the **↑/↓** (cursor up/down) buttons to choose a language, then press **ENTER**.

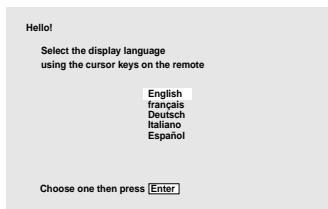

- 2 Press **ENTER** to move on to the next screen.

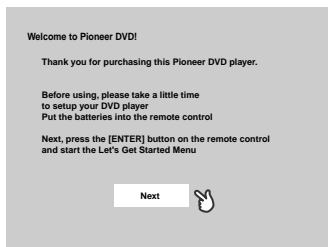

- 3 Use the \leftarrow/\rightarrow (cursor left/right) buttons to select either 'Wide screen (16:9)' or 'Standard size screen (4:3)' according to the kind of TV you have, then press **ENTER**.

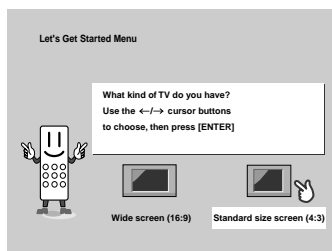

- 4 Press **ENTER** again to finish setting up.

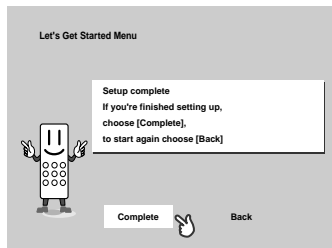

- Select **Back** then press **ENTER** if you want to go back and change the setting you just made.

Using the on-screen displays

For ease of use, this player makes extensive use of graphical on-screen displays (OSDs). You should get used to the way these work as you'll need to use them when setting up the player, using some of the playback features, such as program play, and when making more advanced settings for audio and video.

All the screens are navigated in basically the same way, using the cursor buttons to change the highlighted item and pressing **ENTER** to select it.



Important

- Throughout this manual, 'Select' means use the cursor buttons to highlight an item on-screen, then press **ENTER**.

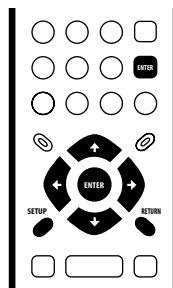

Button	What it does
SETUP	Display/exit the on-screen display
$\leftarrow \uparrow \downarrow \rightarrow$	Changes the highlighted menu item
ENTER	Selects the highlighted menu item (both ENTER buttons work in exactly the same way)
RETURN	Returns to the main menu without saving changes



Tip

- The button guide at the bottom of every OSD screen shows you which buttons you'll need to use for that screen.

Setting up with the Setup Navigator

Using the Setup Navigator you can make a number of other initial settings for this player. We recommend using the Setup Navigator, especially if you connected this player to an AV receiver for playing surround sound. To answer some of the questions about digital audio formats you may need to look at the instructions that came with your AV receiver.

1 If a disc is playing, press ■ (stop).

Also turn on your TV and make sure that it is set to the correct video input.

2 Press SETUP.

The on-screen display (OSD) appears.

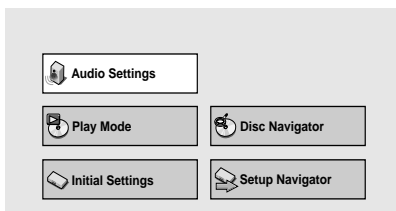

3 Select 'Setup Navigator'.

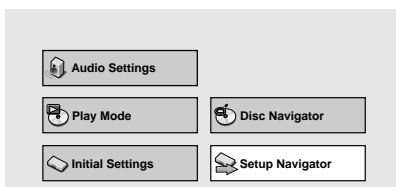

4 Select a DVD language.

Some DVD discs feature on-screen menus, soundtracks and subtitles in several languages. Set your preferred language here.

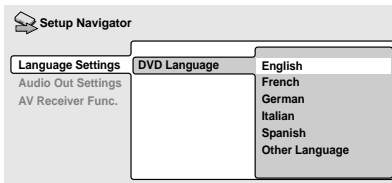

- Note that the language you choose here may not be available on all discs.
- If you want to select a language other than those listed, select **Other Language**. See *Selecting languages using the language code list* on **page 51** for detailed information.

5 Did you connect this player to an amplifier or AV receiver?

Select **Connected** or **Not Connected**.

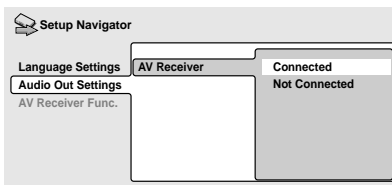

- If you selected **Not Connected** here, that completes setup using the Setup Navigator. Press **ENTER** to exit.

6 Did you connect this player to an AV receiver using a digital output?

Select **Connected** or **Not Connected**.

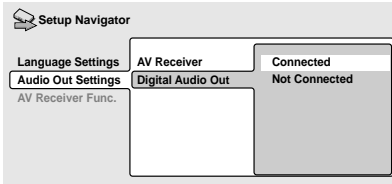

- If you selected **Not Connected** here, that completes setup using the Setup Navigator. Press **ENTER** to exit.

7 Is your AV receiver Dolby Digital compatible?

Select **Compatible**, **Not Compatible** or **Don't Know**.

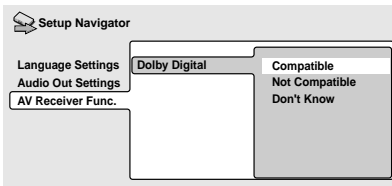

8 Is your AV receiver DTS compatible?

Select **Compatible**, **Not Compatible** or **Don't Know**.

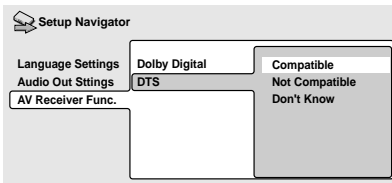

9 Is your AV receiver MPEG compatible?

Select **Compatible**, **Not Compatible** or **Don't Know**.

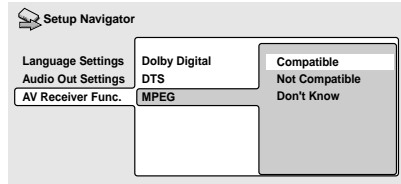

10 Is your AV receiver compatible with 96kHz Linear PCM audio?

Select **Compatible**, **Not Compatible** or **Don't Know**.

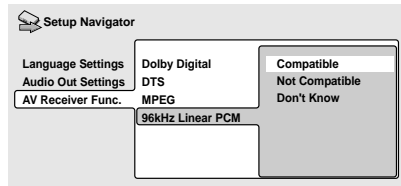

11 Press ENTER to complete the setup, or press SETUP to quit the Setup Navigator without making any changes.

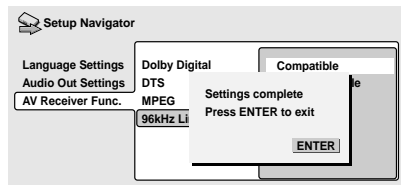

Congratulations, setup is complete!

Playing discs

The basic playback controls for playing DVD, CD, Video CD and MP3 discs are covered here. Further functions are detailed in the next chapter.

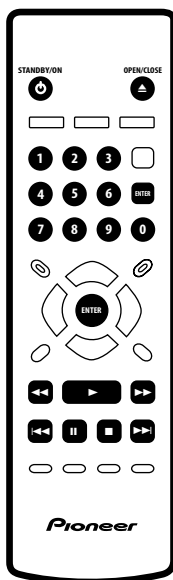

1 If the player isn't already on, press **⏻** STANDBY/ON to switch it on.

If you're playing a DVD or Video CD, also turn on your TV and make sure that it is set to the correct video input.

2 Press **⏮** OPEN/CLOSE to open the disc tray.

3 Load a disc.

Load a disc with the label side facing up, using the disc tray guide to align the disc (if you're loading a double-sided DVD disc, load it with the side you want to play face down).

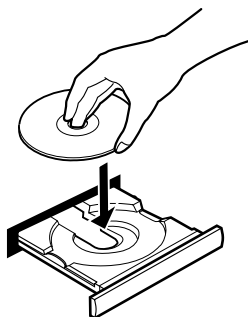

4 Press **▶** (play) to start playback.

If you're playing a DVD or Video CD, a menu may appear. See **pages 25, 26** for how to navigate these.

If you're playing an MP3 disc, it may take a few seconds before playback starts, depending on the complexity of the file structure on the disc.

FAQ

- *After I load a DVD disc, it ejects automatically after a few seconds!*

Most likely, the disc is the wrong region for your player. The region number should be printed on the disc; check it against the region number of the player (which you can find on the rear panel). See also **page 9**.

If the region number is OK, it may be that the disc is damaged or dirty. Clean the disc and look for signs of damage. See also **page 47**.

- *Why won't the disc I loaded play?*

First check that you loaded the disc the right way up (label side up), and that it's clean and not damaged. See **page 47** for information on cleaning discs.

If a disc loaded correctly won't play, it's probably an incompatible format or disc type, such as DVD-Audio or DVD-ROM. See **page 8** for more on disc compatibility.

- *I have a widescreen TV so why are there black bars at the top and bottom of the screen when I play some discs?*

Some movie formats are such that even when played on a widescreen TV, black bars are necessary at the top and bottom of the screen. This is not a malfunction.

- *I have a standard (4:3) TV and set the player to show widescreen DVDs in pan & scan format, so why do I still get black bars top and bottom with some discs?*











Some discs override the display preferences of the player, so even if you have **4:3 (Pan & Scan)** selected, those discs will still be shown in letterbox format. This is not a malfunction.

- *My AV receiver is definitely compatible with 96kHz Linear PCM audio, but it doesn't seem to work with this player. What's wrong?*

For digital copy-protection purposes, some 96kHz DVD discs are automatically downsampled to 48kHz. This is not a malfunction. With these kinds of discs, if you want to enjoy high-quality analog audio, set **Digital Out** to **Off** (**page 39**), and **96kHz PCM Out** to **96kHz** (**page 40**).

Basic playback controls

The table below shows the basic controls on the remote for playing discs. The following chapter covers more playback features in more detail.

Button	What it does
	Starts playback. DVD and Video CD: if the display shows RESUME , playback starts from the resume point.
	Pauses a disc that's playing, or restarts a paused disc.
	Stops playback. DVD and Video CD: Display shows RESUME . Press  (stop) again to cancel the resume function.
	Press to start fast reverse scanning. Press  (play) to resume normal playback.
	Press to start fast forward scanning. Press  (play) to resume normal playback.
	Skips to the start of the current track or chapter, then to previous tracks/chapters.
	Skips to the next track or chapter.
Numbers	Use to enter a title/track number. Press ENTER to select (or wait a few seconds). <ul style="list-style-type: none"> • If the disc is stopped, playback starts from the selected title (for DVD) or track number (for CD/Video CD/MP3). • If the disc is playing, playback jumps to the start of the selected chapter or track.

Front panel controls

The ► (play), ■ (stop), and || (pause) buttons on the front panel work in exactly the same way as their remote control equivalents. The combined scan/skip buttons on the front panel (|◀◀◀ and ▶▶▶|) work slightly differently from the remote buttons.

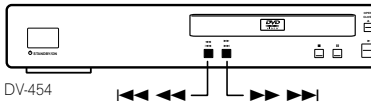

Press and hold for fast scan; press for track/chapter skip.



Important

- You may find with some DVD discs that some playback controls don't work in certain parts of the disc. This is not a malfunction.
- Track skip and number buttons for track selection do not work with unfinalized CD-R/RW discs.

DVD-Video disc menus

Many DVD-Video discs contain menus from which you can select what you want to watch. They may give access to additional features, such as subtitle and audio language selection, or special features such as slideshows. See the disc packaging for details.

Sometimes DVD-Video menus are displayed automatically when you start playback; others only appear when you press **MENU** or **TOP MENU**.

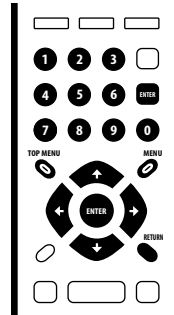

Button	What it does
TOP MENU	Displays the 'top menu' of a DVD disc—this varies with the disc.
MENU	Displays a DVD disc menu—this varies with the disc and may be the same as the 'top menu'.
◀ ▶	Moves the cursor around the screen.
ENTER	Selects the current menu option.
RETURN	Returns to the previously displayed menu screen.
Numbers	Highlights a numbered menu option (some discs only). Press ENTER to select.

Video CD PBC menus

Some Video CDs have menus from which you can choose what you want to watch. These are called PBC (Playback control) menus.

You can play a PBC Video CD without having to navigate the PBC menu by starting playback using a number button to select a track, rather than the ► (play) button.

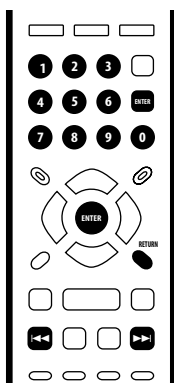

Button	What it does
RETURN	Displays the PBC menu.
Numbers	Use to enter a numbered menu option. Press ENTER to select.
◀◀	Displays the previous menu page (if there is one).
▶▶	Displays the next menu page (if there is one).

Introduction

Most of the features described in this chapter make use of on-screen displays. For an explanation of how to navigate these, see *Using the on-screen displays* on **page 20**.

Many of the functions covered in this chapter apply to DVD discs, Video CDs, CDs and MP3 discs, although the exact operation of some varies slightly with the kind of disc loaded.

Some DVD discs restrict the use of some functions (random or repeat, for example). This is not a malfunction.

When playing Video CDs, some of the functions are not available during PBC playback. If you want to use them, start the disc playing using a number button to select a track.

Using the Disc Navigator to browse the contents of a disc

Use the Disc Navigator to browse through the contents of a disc to find the part you want to play. You can use the Disc Navigator when a disc is playing or stopped.

1 Press **SETUP** and select 'Disc Navigator' from the on-screen display.

Alternatively, if a CD, Video CD or MP3 disc is loaded, you can press **MENU**, which takes you straight to the Disc Navigator screen.

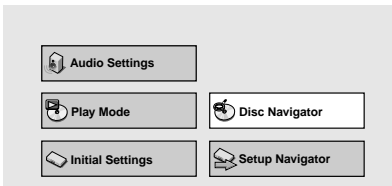

2 Select what you want to play.

Depending on the type of disc you have loaded, the Disc Navigator looks slightly different.

The screen for DVD discs shows the titles on the left and the chapters on the right. Select a title, or a chapter within a title.

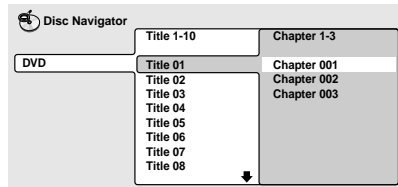

The screen for CDs and Video CDs shows a list of tracks.

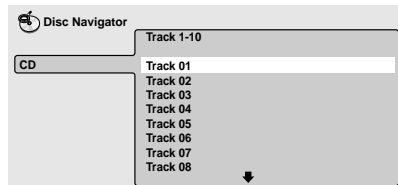

The screen for an MP3 disc shows the folder names on the left and the track names on the right (note that if there are more than 16 folders or names that contain accented or non-roman characters, tracks and folders may show up with generic names – F_033, T_035, etc.).

Select a folder, or a track within a folder.

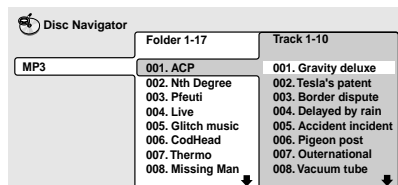

Playback starts after you press **ENTER**.

**Tip**

- The Disc Navigator is not available unless there is a disc loaded.
- It's not possible to use the Disc Navigator when playing a Video CD in PBC mode, or an unfinalized CD-R/RW disc.
- Another way to find a particular place on a disc is to use one of the search modes. See *Searching a disc* on **page 34**.

Scanning discs

You can fast-scan discs forward or backward at various different speeds.

1 During playback, press ◀◀ or ▶▶ to start scanning.

2 Press repeatedly to increase the scanning speed.

- MP3s can only be scanned at one speed.
- The scanning speed is shown on-screen.

3 To resume normal playback, press ▶ (play).

**Note**

- Sound can be heard while scanning audio CDs and MP3 discs.
- When scanning a Video CD or MP3 track, playback automatically resumes at the end or beginning of the track.
- There is no sound while scanning DVDs and Video CDs, and no subtitles while scanning DVDs.
- Depending on the disc, normal playback may automatically resume when a new chapter is reached on a DVD disc.

Playing in slow motion

You can play DVDs and Video CDs at four different forward slow motion speeds, and DVDs also at two reverse speeds.

1 During playback, press II (pause).

2 Press and hold ◀|◀II or II|▶ until slow motion playback starts.

- The slow motion speed is shown on-screen.
- There is no sound during slow motion playback.

3 Press repeatedly to change the slow motion speed.

- The slow motion speed is displayed on-screen.

4 To resume normal playback, press ▶ (play).

**Note**

- Video CD only supports forward slow motion playback.
- The picture quality during slow motion playback is not as good as during normal playback.
- Depending on the disc, normal playback may automatically resume when a new chapter is reached.

Frame advance/frame reverse

You can advance or back up a DVD disc frame-by-frame. With Video CDs, you can only use frame advance.

1 During playback, press II (pause).

2 Press ◀|◀II or II|▶ to reverse or advance a frame at a time.

3 To resume normal playback, press ▶ (play).

 **Note**

- The picture quality when using frame reverse is not as good as frame advance.
- Depending on the disc, normal playback may automatically resume when a new chapter is reached.
- When changing direction with a DVD disc, the picture may 'move' in an unexpected way. This is not a malfunction.

Looping a section of a disc

The A-B Repeat function allows you to specify two points (A and B) within a track (CD and Video CD) or title (DVD) that form a loop which is played over and over.

A-B Repeat is not available with MP3 discs, Video CDs in PBC mode, or unfinalized CD-R/RW discs.

1 During playback, press PLAY MODE and select 'A-B Repeat' from the list of functions on the left.

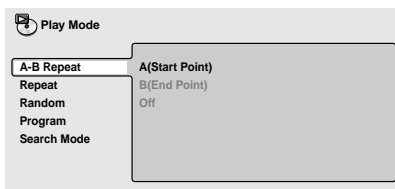

2 Press ENTER on 'A(Start Point)' to set the loop start point.

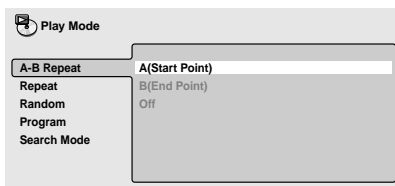

3 Press ENTER on 'B(End Point)' to set the loop end point.

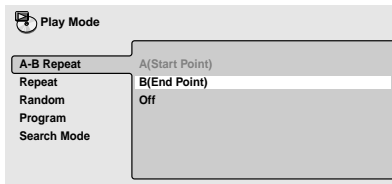

After pressing **ENTER**, playback jumps back to the start point and plays the loop.

- The minimum loop time is 2 seconds.

4 To resume normal playback, select 'Off' from the menu.

Using repeat play

There are various repeat play options, depending on the kind of disc loaded. It's also possible to use repeat play together with program play to repeat the tracks/chapters in the program list (see *Creating a program list* on page 31).

Repeat play is not available with Video CDs in PBC mode, or unfinalized CD-R/RW discs.

1 During playback, press PLAY MODE and select 'Repeat' from the list of functions on the left.

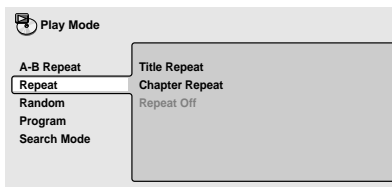

2 Select a repeat play option.

If program play is active, select **Program Repeat** to repeat the program list, or **Repeat Off** to cancel.

For DVD discs, select **Title Repeat** or **Chapter Repeat** (or **Repeat Off**).

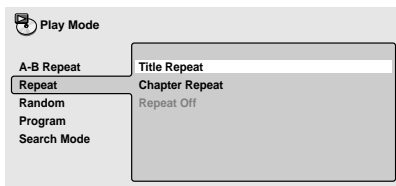

For CDs and Video CDs, select **Disc Repeat** or **Track Repeat** (or **Repeat Off**).

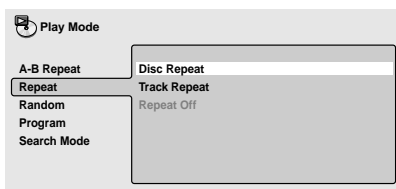

For MP3 discs, select **Disc Repeat**, **Folder Repeat** or **Track Repeat** (or **Repeat Off**).

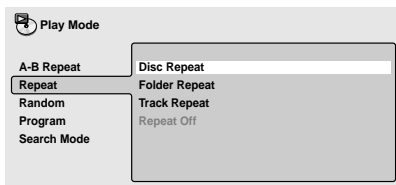

Note

- You can't use repeat and random play at the same time.
- If you switch camera angle during repeat play, repeat play is canceled.

Using random play

Use the random play function to play titles or chapters (DVD) or tracks (CD, Video CD and MP3 discs) in a random order.

You can set the random play option when a disc is playing or stopped.

1 Press PLAY MODE and select 'Random' from the list of functions on the left.

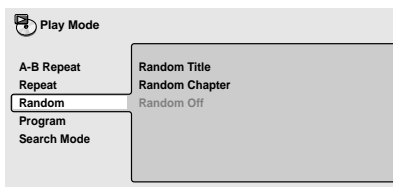

2 Select a random play option.

For DVD discs, select **Random Title** or **Random Chapter** (or **Random Off**).

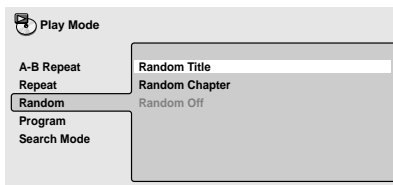

For CDs, Video CDs and MP3 discs, select **On** or **Off** to switch random play on or off. (Note that when used with MP3 discs, only tracks from within the current folder are played.)

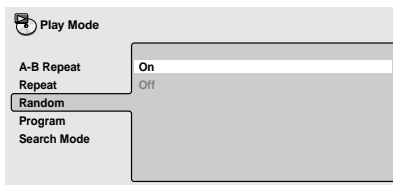

Tip

- To stop the disc and cancel random playback, press **■** (stop).
- To cancel random playback without stopping playback, press **CLEAR**. The disc will play to the end, then stop.
- During random play, the **◀◀** and **▶▶** buttons function a little differently to normal: **◀◀** returns to the beginning of the current track/chapter. You can't go back further than this. **▶▶** selects another track/chapter at random from those remaining.
- You can't use random play together with program or repeat play.

Note

- You can't use random play with Video CDs playing in PBC mode, or unfinalized CD-R/RW discs.

Creating a program list

This feature lets you program the play order of titles/chapters/folders/tracks on a disc.

Program play is not available with Video CDs playing in PBC mode, or unfinalized CD-R/RW discs.

1 Press **PLAY MODE** and select '**Program**' from the list of functions on the left.

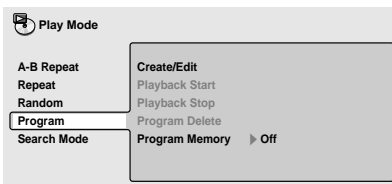

2 Select '**Create/Edit**' from the list of program options.

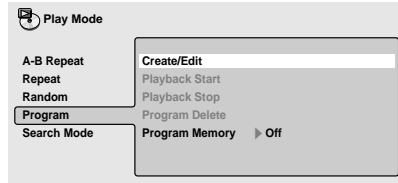

The Program edit screen that appears depends on the kind of disc loaded.

On the left side is the program list, then to the right is a list of titles (if a DVD disc is loaded), tracks (for CDs and Video CDs), or folder names (for MP3 discs). On the far right is a list of chapters (for DVD) or track names (for MP3).

3 Select a title, chapter, folder or track for the current step in the program list.

For a DVD disc, you can add a whole title, or a chapter within a title to the program list.

- To add a title, select the title.

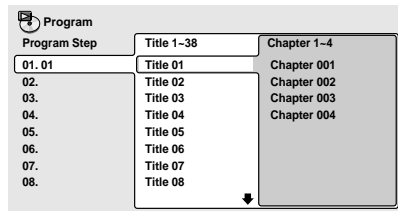

- To add a chapter, first highlight the title, then press **→** (cursor right) and select a chapter from the list.
- To add a track, first find the folder, then press **→** (cursor right) and select a track name from the list.

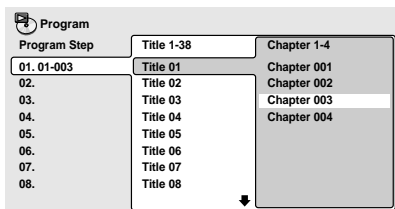

For a CD or Video CD, select a track to add to the program list.

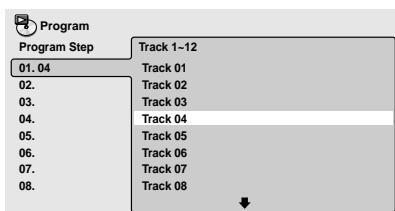

For an MP3 disc, you can add a whole folder, or a track within a folder to the program list.

- To add a folder, select the folder.

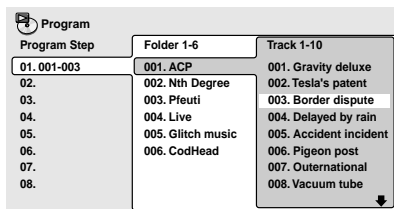
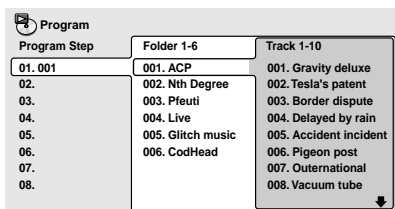

After pressing **ENTER** to select the title/chapter/folder/track, the step number automatically moves down one.

4 Repeat step 3 to build up a program list.

A program list can contain up to 24 titles/chapters/folders/tracks.

5 To play the program list, press **▶** (play).

Program play remains active until you turn off program play (see below), erase the program list (see below), eject the disc or switch off the player.



Tip

- To save your program list and exit the program edit screen without starting playback, press **PLAY MODE** or **SETUP**. (Don't press **RETURN** – your program list won't be saved.)
- During program play, press **▶▶** to skip to the next program step.
- Press **CLEAR** during playback to switch off program play. Press while stopped to erase the program list.

Editing a program list

After creating a program list, you can add, delete and change steps.

1 Press PLAY MODE and select 'Program' from the list of functions on the left.

2 Select 'Create/Edit' from the list of program options.

3 To clear a step, highlight the step number and press CLEAR.

4 To insert a step in the middle of the program list, highlight the step where you want the new step to appear, then select a title/chapter/folder/track to add.

After pressing **ENTER**, the new step is inserted into the list.

5 To add a step to the end of the program list, highlight the next free step then select a title/chapter/folder/track to add.



Tip

- To save your program list and exit the program edit screen without starting playback, press **PLAY MODE** or **SETUP**.
- If you want to exit the program edit screen without saving the changes you made, press **RETURN**.

Other functions available from the program menu

As well as creating and editing a program list, you can start program play, cancel program play, erase the program list, and memorize a program list from the Play Mode menu.

1 Press PLAY MODE and select 'Program' from the list of functions on the left.

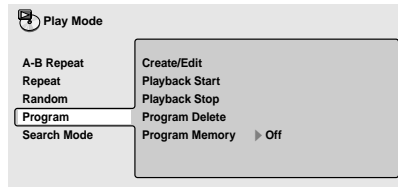

2 Select a program play function.

- **Create/Edit** – See above
- **Playback Start** – Starts playback of a saved program list
- **Playback Stop** – Turns off program play, but does not erase the program list
- **Program Delete** – Erases the program list and turns off program play
- **Program Memory (DVD only)** – Select **On** to save the program list for the disc loaded. (Select **Off** to cancel the program memory for the disc loaded)



Tip

- Program lists are saved for the disc loaded. When you load a disc with a saved program list, program play is automatically turned on.
- You can save program lists for up to 24 discs. After that, the oldest one is replaced with the new one saved.

Searching a disc

You can search DVD discs by title or chapter number, or by time. CDs can be searched by track number, and Video CDs by track number or time. MP3 discs can be searched by folder or track number.

1 Press PLAY MODE and select 'Search Mode' from the list of functions on the left.

The search options that appear depend on the kind of disc loaded. The screen below shows the DVD search options.

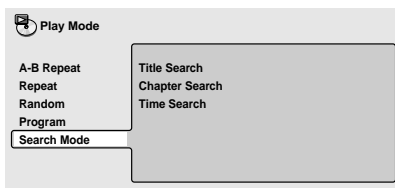

2 Select a search mode.

3 Use the number buttons to enter a title, chapter, folder or track number, or a time.

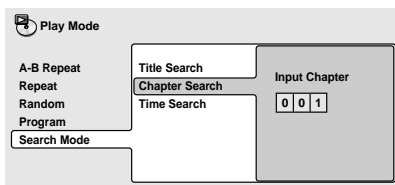

- For a time search, enter the number of minutes and seconds into the currently playing title (DVD) or track (Video CD) you want playback to resume from. For example, press **4, 5, 0, 0** to have playback start from 45 minutes into the disc. For 1 hour, 20 minutes and 30 seconds, press **8, 0, 3, 0**.

4 Press ENTER to start playback.



Note

- The disc must be playing in order to use time search.
- Search functions are not available with Video CDs in PBC mode, or unfinalized CD-R/RW discs.

Switching subtitles

Some DVD discs have subtitles in one or more languages; the disc box will usually tell you which subtitle languages are available. You can switch subtitle language during playback.

1 Press SUBTITLE repeatedly to select a subtitle option.

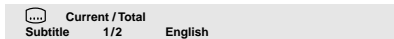

- To set subtitle preferences, see *Subtitle Language* on **page 42**.

Switching DVD audio language

When playing a DVD disc recorded with dialog in two or more languages, you can switch audio language during playback.

1 Press AUDIO repeatedly to select an audio language option.



- To set audio language preferences, see *Audio Language* on **page 42**.

Switching audio channel when playing a Video CD

When playing a Video CD, you can switch between stereo, just the left channel or just the right channel.

1 Press AUDIO repeatedly to select an audio channel option.



Zooming the screen

Using the zoom feature you can magnify a part of the screen by a factor of 2 or 4, while watching a DVD or Video CD.

1 During playback, use the ZOOM button to select the zoom factor.

- Normal
- 2x
- 4x

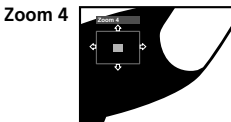
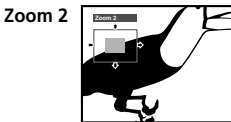
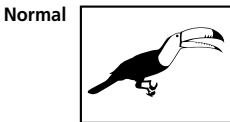

- Since DVD and Video CD has a fixed resolution, picture quality will deteriorate, especially at 4x zoom. This is not a malfunction.

2 Use the cursor buttons to change the zoomed area.

You can change the zoom factor and the zoomed area freely during playback.

- If the navigation square at the top of the screen disappears, press **ZOOM** again to display it.



Note

- We do not recommend using DVD disc menus when the screen is zoomed as menu options will not be highlighted.
- If you are displaying subtitles, these will disappear when the screen is zoomed. They will reappear when you return the screen to normal,

Switching camera angles

Some DVD discs feature scenes shot from two or more angles—check the disc box for details.

When a multi-angle scene is playing, a  icon appears on screen to let you know that other angles are available (this can be switched off if you prefer—see **page 44**).

1 During playback (or when paused), press ANGLE to switch angle.

Audio DRC

- Default setting: **Off**

When watching Dolby Digital DVDs at low volume, it's easy to lose the quieter sounds completely—including some of the dialog. Switching Audio DRC (Dynamic Range Control) to **On** can help by bringing up the quieter sounds, while controlling loud peaks.

How much of a difference you hear depends on the material you're listening to. If the material doesn't have wide variations in volume, you may not notice much change.

- 1 Press **SETUP** and select 'Audio Settings' from the on-screen display.

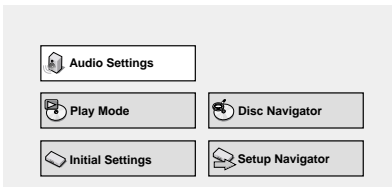

- 2 Highlight **Audio DRC**, then use the **←/→** buttons (cursor left/right) to change to 'On' or 'Off', as required.



- 3 Press **ENTER** to make the setting and exit the Audio Settings screen.



Note

- Audio DRC is only effective with Dolby Digital audio sources.
- Audio DRC is only effective through the digital output when **Digital Out** is set to **On**, and **Dolby Digital Out** is set to **Dolby Digital > PCM**. See **page 39**.
- The effect of Audio DRC depends on your speakers and AV receiver settings.

Virtual Surround

- Default setting: **Off**

Switch on Virtual Surround to enjoy surround sound effects from just two speakers.

When you play a Dolby Digital soundtrack, Virtual Dolby Digital, which uses TruSurround technology from SRS, produces a deep, realistic 3D soundspace from a pair of stereo speakers.

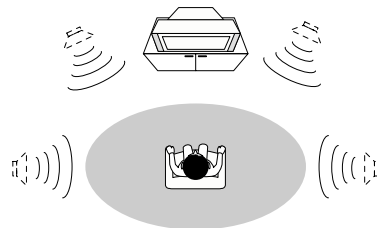

TruSurround™
by **SRS** (●)

1 Press **SETUP** and select 'Audio Settings' from the on-screen display.

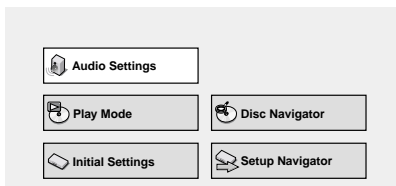

2 Highlight **Virtual Surround**, then use the **←/→** buttons (cursor left/right) to change to '**Dolby/TruSurround**' or '**Off**', as required.



3 Press **ENTER** to make the setting and exit the Audio Settings screen.



Tip

- You can also use the **SURROUND** button on the remote control to switch Virtual Surround on (**Dolby/TruSurround**)/**Off**.



Note

- Virtual Surround doesn't work with DTS or 96kHz linear PCM audio, or during MP3 playback, through either the analog or digital outputs.
- If the player is outputting Dolby Digital or MPEG bitstream audio (in other words, no conversion to PCM), Virtual Surround has no effect on the audio from the digital output. See **pages 39–40** for how to set up the digital output formats.
- How good the surround effect is varies with the disc.

Using the Initial Settings menu

The Initial Settings menu gives you complete control in setting up your DVD player, including audio, and video output settings, audience limitation settings, among others. If an option is grayed out it means that it cannot be changed at the current time. This is usually because a disc is playing. Stop the disc, then change the setting.

1 Press **SETUP** and select 'Initial Settings' from the on-screen display.

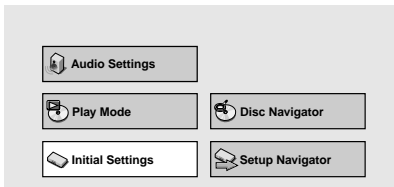

2 Select the setup category from the list on the left, then select an item from the menu list to the right.

3 Make the setting you want.

Note

- The language options shown in the on-screen display illustrations on the following pages may not correspond to those available in your country or region.

Digital Audio Out settings

Digital Out

- Default setting: **On**

You only need to make this setting if you connected this system to an AV receiver (or other component) using one of the digital outputs.

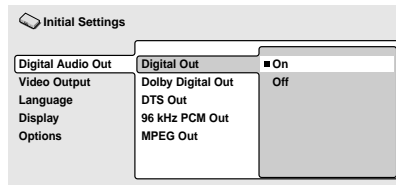

If at any time you need to switch off the digital audio output, set this to **Off**, otherwise leave it **On**.

Note that you can't switch on/off the optical and coaxial outputs individually.

Dolby Digital Out

- Default setting: **Dolby Digital**

You only need to make this setting if you connected this system to an AV receiver (or other component) using one of the digital outputs.

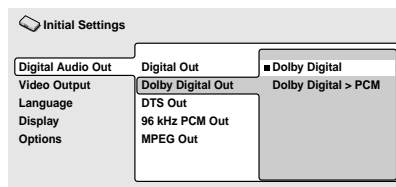

If your AV receiver (or other connected component) is Dolby Digital compatible, set to **Dolby Digital**, otherwise set to **Dolby Digital > PCM**.

DTS Out

- Default setting: **Off**

You only need to make this setting if you connected this system to an AV receiver (or other component) using one of the digital outputs.

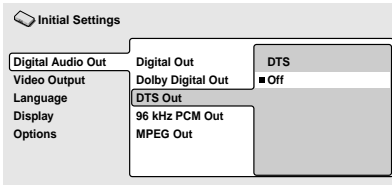

If your AV receiver (or other connected component) has a built-in DTS decoder, set this to **DTS**, otherwise set to **Off**. Check the manual that came with the other component if you're unsure whether it is DTS compatible.



Note

- If you set to **DTS** with a non-DTS compatible amplifier, noise will be output when you play a DTS disc.

96kHz PCM Out

- Default setting: **96kHz > 48kHz**

You only need to make this setting if you connected this system to an AV receiver (or other component) using one of the digital outputs.

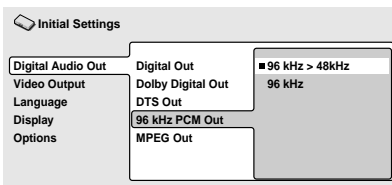

If your AV receiver (or other connected component) is compatible with high sampling rates (96 kHz), set this to **96kHz**, otherwise set it to **96kHz > 48kHz** (96 kHz audio is converted to a more compatible 48 kHz). Check the manual that came with the other component if you're unsure whether it is 96 kHz compatible.

MPEG Out

- Default setting: **MPEG > PCM**

You only need to make this setting if you connected this system to an AV receiver (or other component) using one of the digital outputs.

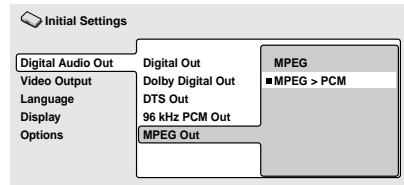

If your AV receiver (or other connected component) is compatible with MPEG audio, set this to **MPEG**, otherwise set it to **MPEG > PCM** (MPEG audio is converted to more compatible PCM audio). Check the manual that came with the other component if you're unsure whether it is MPEG audio compatible.

Video Output settings

TV Screen

- Default setting: **4:3 (Letter Box)**

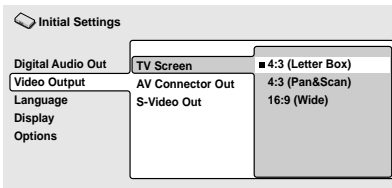

If you have a widescreen TV, select the **16:9 (Wide)** setting—widescreen DVD software is then shown using the full screen area. When playing software recorded in conventional (4:3) format, the settings on your TV will determine how the material is presented—see the manual that came with your TV for details on what options are available.

If you have a conventional TV, select either **4:3 (Letter Box)** or **4:3 (Pan & Scan)**. In Letter Box mode, widescreen software is shown with black bars at the top and bottom of the screen. Pan & Scan chops the sides off widescreen material to make it fit the 4:3 screen (so even though the image looks larger on the screen, you're actually seeing less of the picture). See also **page 49**.

AV Connector Out

- Default setting: **Video**

You only need to make this setting if you connected this player to your TV using the AV SCART-type connector.



Important

- If you make a setting here that is incompatible with your TV, the TV may not display any picture at all. If this happens either switch everything off

and reconnect to the TV using either the supplied audio/video cable, or an S-Video cable (see **pages 11** and **12** for more on this).

- SCART cables come in various configurations. Make sure you use the correct one for your TV/monitor. See **page 54** for the SCART pin assignment diagram.

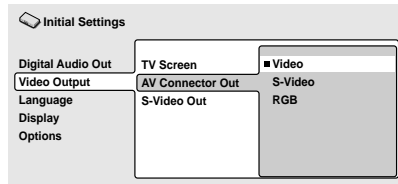

- **Video** – Standard video, compatible with all TVs.
- **S-Video** – Higher quality, but check your TV for compatibility.
- **RGB** – Best quality, but check your TV for compatibility.

S-Video Out

- Default setting: **S2**

You only need to make this setting if you connected this player to your TV using an S-Video cord.

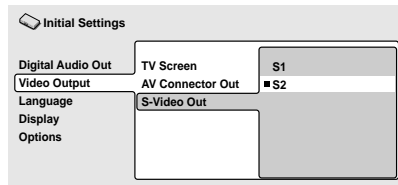

If you find that the picture is stretched or distorted on the default **S2** setting, try changing it to **S1**.

Language settings

Audio Language

- Default setting: **English**

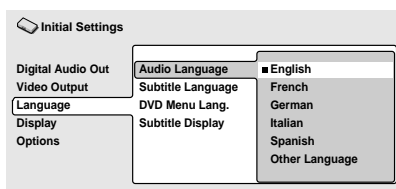

This setting is your preferred audio language for DVD discs. If the language you specify here is recorded on a disc, the system automatically plays the disc in that language.

The DVD format recognizes 136 different languages. Select **Other Language** if you want to specify a language other than those listed. See also *Selecting languages using the language code list* on **page 51**.

Tip

- You can switch between the languages recorded on a DVD disc during playback using the **AUDIO** button. (This does not affect this setting.) See **page 34**.
- Some DVD discs set the audio language automatically when loaded, overriding the audio language you set in the Initial Settings menu.
- Discs with two or more audio languages usually allow you to select the audio language from the disc menu. Press **MENU** to access the disc menu.

Subtitle Language

- Default setting: **English**

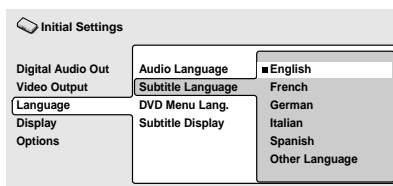

This setting is your preferred subtitle language for DVD discs. If the language you specify here is recorded on a disc, the system automatically plays the disc with those subtitles.

The DVD format recognizes 136 different languages. Select **Other Language** if you want to specify a language other than those listed. See also *Selecting languages using the language code list* on **page 51**.

Tip

- You can change or switch off the subtitles on a DVD disc during playback using the **SUBTITLE** button. (This does not affect this setting.) See **page 34**.
- Some DVD discs set the subtitle language automatically when loaded, overriding the subtitle language you set in the Initial Settings menu.
- Discs with two or more subtitle languages usually allow you to select the subtitle language from the disc menu. Press **MENU** to access the disc menu.

DVD Menu Language

- Default setting: **w/Subtitle Lang.**

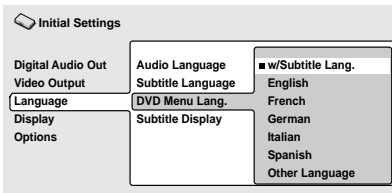

Some multilingual discs have disc menus in several languages. This setting specifies in which language the disc menus should appear. Leave on the default setting for menus to appear in the same language as your Subtitle Language—see [page 42](#).

The DVD format recognizes 136 different languages. Select **Other Language** if you want to specify a language other than those listed. See also *Selecting languages using the language code list* on [page 51](#).

Subtitle Display

- Default setting: **On**

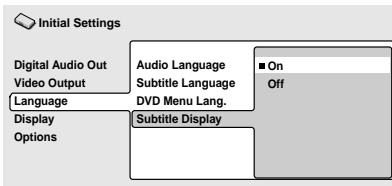

When set to **On**, the player displays subtitles according to the Subtitle Language setting. Set to **Off** to switch subtitles off altogether.

Display settings

OSD Language

- Default setting: **English**

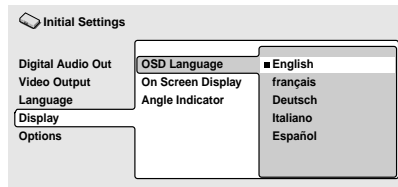

This sets the language of this player's on-screen displays.

On Screen Display

- Default setting: **On**

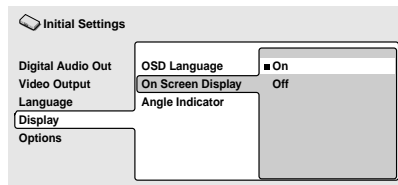

This sets whether operation displays are shown on-screen (**Play**, **Resume**, **Scan** and so on.)

Angle Indicator

- Default setting: **On**

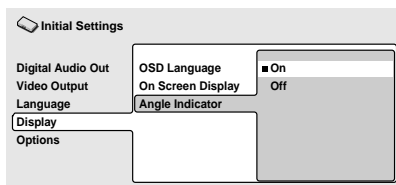

If you prefer not to see the camera icon on-screen during multi-angle scenes on DVD discs, change this setting to **Off**.

Options

Parental Lock

- Default level: **Off**
- Default password: **none**
- Default country code: **us (2119)**

Some DVD Video discs feature a Parental Lock level. If your player is set to a lower level than the disc, the disc won't play. This gives you some control about what your children watch on your DVD player.

Some discs also support the Country Code feature. The player does not play certain scenes on these discs, depending on the country code you set.

Before you can set the Parental Lock level or the Country Code you must register a password. As the password owner, you can change the Parental Lock level or Country Code whenever you like. You can also change the password.



Note

- Not all discs that you may consider inappropriate for your children use the Parental Lock feature. These discs will always play without requiring the password first.
- If you forget your password, you'll need to reset the player to its factory settings (**page 49**), then register a new password.

Registering a new password

You must register a password before you can change the Parental Lock level or enter a Country Code.

1 Select 'Password'.

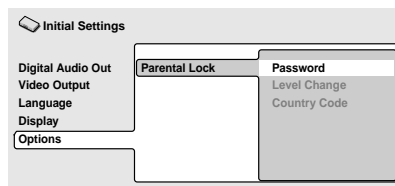

2 Use the number buttons to enter a 4-digit password.

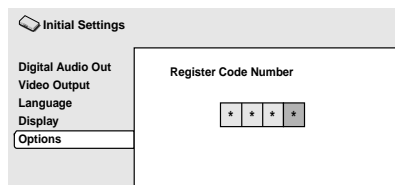

The numbers you enter show up as asterisks (*) on-screen.

3 Press ENTER to register the password and return to the Options menu screen.

If you forget your password, you can reset the system then register a new one. See page 49 for how to reset the player.

Changing your password

To change your password, confirm your existing password then enter a new one.

1 Select 'Password Change'.

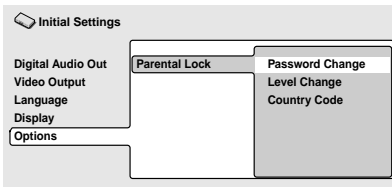

2 Use the number buttons to enter your existing password, then press ENTER.

- The numbers appear as asterisks as you enter them.

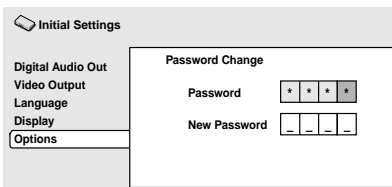

3 Enter a new password.

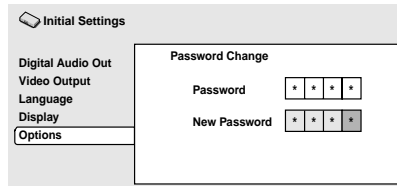

4 Press ENTER to register the new password and return to the Options menu screen.

Setting/changing the Parental Lock level

1 Select 'Level Change'.

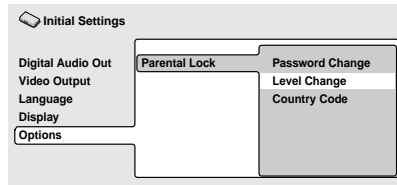

2 Use number buttons to enter your password, then press ENTER.

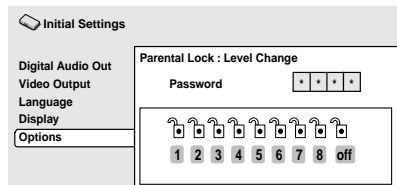

3 Select a new level.

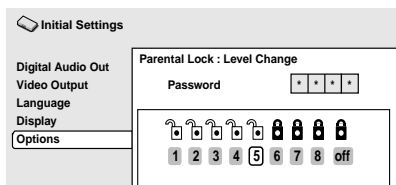

Press ← (cursor left) repeatedly to lock more levels (more discs will require the password); press → (cursor right) to unlock levels. You can't lock level 1.

4 Press ENTER to set the new level and return to the Options menu screen.

Setting/changing the Country Code

You may also want to refer to the Country code list on **page 50**.

1 Select 'Country Code'.

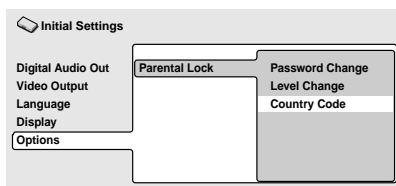

2 Use number buttons to enter your password, then press ENTER.

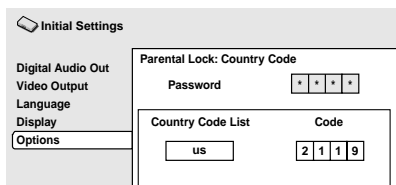

3 Select a country code.

There are two ways you can do this.

- Select by code letter: Use ↑/↓ (cursor up/down) to change the country code.

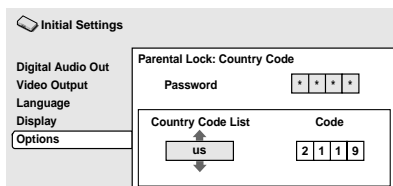

- Select by code number: Press → (cursor right) then use the number buttons to enter the 4-digit country code (you can find the Country code list on **page 50**.)

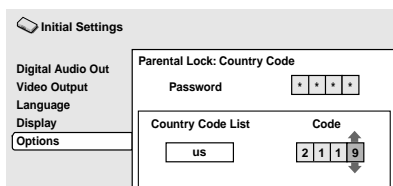

4 Press ENTER to set the new Country Code and return to the Options menu screen.

Note

- Changing the country code does not take effect until the next disc is loaded (or the current disc is reloaded).

Taking care of your player and discs

Handling discs

When holding discs of any type, take care not to leave fingerprints, dirt or scratches on the disc surface. Hold the disc by its edge or by the center hole and edge.

Damaged or dirty discs can affect playback performance. Take care also not to scratch the label side of the disc. Although not as fragile as the recorded side, scratches can still result in a disc becoming unusable.

Should a disc become marked with fingerprints, dust, etc., clean using a soft, dry cloth, wiping the disc lightly from the center to the outside edge as shown in the diagram below.



Wipe lightly from the center of the disc using straight strokes.



Don't wipe the disc surface using circular strokes.

If necessary, use a cloth soaked in alcohol, or a commercially available CD/DVD cleaning kit to clean a disc more thoroughly. Never use benzine, thinner or other cleaning agents, including products designed for cleaning vinyl records.

Storing discs

Although CDs and DVD discs are more durable than vinyl records, you should still take care to handle and store discs correctly. When you're not using a disc, return it to its case and store upright. Avoid leaving discs in excessively cold, humid, or hot environments (including under direct sunlight).

Don't glue paper or put stickers onto the disc, or use a pencil, ball-point pen or other sharp-tipped writing instrument. These could all damage the disc.



For more detailed care information see the instructions that come with discs.

Do not load more than one disc into the player at a time.

Discs to avoid

Discs spin at high speed inside the player. If you can see that a disc is cracked, chipped, warped, or otherwise damaged, don't risk using it in your player—you could end up damaging the unit.

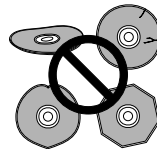

This unit is designed for use with conventional, fully circular discs only. Use of shaped discs is not recommended for this product. Pioneer disclaims all liability arising in connection with the use of shaped discs.

Cleaning the pickup lens

The DVD player's lens should not become dirty in normal use, but if for some reason it should malfunction due to dust or dirt, consult your nearest Pioneer-authorized service center. Although lens cleaners for CD players are commercially available, we do not recommend using them since some may damage the lens.

Problems with condensation

Condensation may form inside the player if it is brought into a warm room from outside, or if the temperature of the room rises quickly. Although the condensation won't damage the player, it may temporarily impair its performance. For this reason you should leave it to adjust to the warmer temperature for about an hour before switching on and using.

Hints on installation

We want you to enjoy using this unit for years to come, so please bear in mind the following points when choosing a suitable location for it:

Do...

- ✓ Use in a well-ventilated room.
- ✓ Place on a solid, flat, level surface, such as a table, shelf or stereo rack.

Don't...

- ✗ Use in a place exposed to high temperatures or humidity, including near radiators and other heat-generating appliances.
- ✗ Place on a window sill or other place where the player will be exposed to direct sunlight.
- ✗ Use in an excessively dusty or damp environment.

- ✗ Place directly on top of an amplifier, or other component in your stereo system that becomes hot in use.
- ✗ Use near a television or monitor as you may experience interference—especially if the television uses an indoor antenna.
- ✗ Use in a kitchen or other room where the player may be exposed to smoke or steam.
- ✗ Use on a thick rug or carpet, or cover with cloth—this may prevent proper cooling of the unit.
- ✗ Place on an unstable surface, or one that is not large enough to support all four of the unit's feet.

Moving the player

If you need to move the player, first press **⏻ STANDBY/ON** on the front panel to turn the player off. Wait for **-OFF-** to disappear from the display, then unplug the power cord. Never lift or move the unit during playback—discs rotate at a high speed and may be damaged.

Power cord caution

Handle the power cord by the plug part. Do not pull out the plug by tugging the cord, and never touch the power cord when your hands are wet, as this could cause a short circuit or electric shock. Do not place the unit, a piece of furniture, or other object on the power cord or pinch the cord in any other way. Never make a knot in the cord or tie it with other cords. The power cords should be routed so that they are not likely to be stepped on. A damaged power cord can cause a fire or give you an electric shock. Check the power cord once in a while. If you find it damaged, ask your nearest Pioneer authorized service center or your dealer for a replacement.

Screen sizes and disc formats

DVD-Video discs come in several different screen aspect ratios, ranging from TV programs, which are generally 4:3, to CinemaScope widescreen movies, with an aspect ratio of up to about 7:3.

Televisions, too, come in different aspect ratios; 'standard' 4:3 and widescreen 16:9.

Widescreen TV users

If you have a widescreen TV, the **TV Screen** setting (**page 41**) of this player should be set to **16:9 (Wide)**.

When you watch discs recorded in 4:3 format, you can use the TV controls to select how the picture is presented. Your TV may offer various zoom and stretch options; see the instructions that came with your TV for details.

Please note that some movie aspect ratios are wider than 16:9, so even though you have a widescreen TV, these discs will still play in a 'letterbox' style with black bars at the top and bottom of the screen.

Standard TV users

If you have a standard TV, the **TV Screen** setting (**page 41**) of this player should be set to **4:3 (Letter Box)** or **4:3 (Pan&Scan)**, depending on which you prefer.

Set to **4:3 (Letter Box)**, widescreen discs are shown with black bars top and bottom.



Set to **4:3 (Pan&Scan)**, widescreen discs are shown with the left and right sides cropped. Although the picture looks larger, you don't actually see the whole picture.



Please note that many widescreen discs override the player's settings so that the disc is shown in letterbox format regardless of the setting.



Tip

- Using the **16:9 (Wide)** setting with a standard 4:3 TV, or either of the **4:3** settings with a widescreen TV, will result in a distorted picture.

Resetting the player

Use this procedure to reset all the player's settings to the factory default.

1 Switch the player into standby.

2 Using the front panel buttons, hold down the ■ (stop) button and press ⏻ STANDBY/ON to switch the player back on.

All the player's settings are now reset, and you should see the 'Let's Get Started' screen.

Language code list

Language (Language code letter), **Language code**

Japanese (ja), 1001	Bhutani (dz), 0426	Kirghiz (ky), 1125	Sinhalese (si), 1909
English (en), 0514	Esperanto (eo), 0515	Latin (la), 1201	Slovak (sk), 1911
French (fr), 0618	Estonian (et), 0520	Lingala (ln), 1214	Slovenian (sl), 1912
German (de), 0405	Basque (eu), 0521	Laothian (lo), 1215	Samoan (sm), 1913
Italian (it), 0920	Persian (fa), 0601	Lithuanian (lt), 1220	Shona (sn), 1914
Spanish (es), 0519	Finnish (fi), 0609	Latvian (lv), 1222	Somali (so), 1915
Chinese (zh), 2608	Fiji (fj), 0610	Malagasy (mg), 1307	Albanian (sq), 1917
Dutch (nl), 1412	Faroese (fo), 0615	Maori (mi), 1309	Serbian (sr), 1918
Portuguese (pt), 1620	Frisian (fy), 0625	Macedonian (mk), 1311	Siswati (ss), 1919
Swedish (sv), 1922	Irish (ga), 0701	Malayalam (ml), 1312	Sesotho (st), 1920
Russian (ru), 1821	Scots-Gaelic (gd), 0704	Mongolian (mn), 1314	Sundanese (su), 1921
Korean (ko), 1115	Galician (gl), 0712	Moldavian (mo), 1315	Swahili (sw), 1923
Greek (el), 0512	Guarani (gn), 0714	Marathi (mr), 1318	Tamil (ta), 2001
Afar (aa), 0101	Gujarati (gu), 0721	Malay (ms), 1319	Telugu (te), 2005
Abkhazian (ab), 0102	Hausa (ha), 0801	Maltese (mt), 1320	Tajik (tg), 2007
Afrikaans (af), 0106	Hindi (hi), 0809	Burmese (my), 1325	Thai (th), 2008
Amharic (am), 0113	Croatian (hr), 0818	Nauru (na), 1401	Tigrinya (ti), 2009
Arabic (ar), 0118	Hungarian (hu), 0821	Nepali (ne), 1405	Turkmen (tk), 2011
Assamese (as), 0119	Armenian (hy), 0825	Norwegian (no), 1415	Tagalog (tl), 2012
Aymara (ay), 0125	Interlingua (ia), 0901	Occitan (oc), 1503	Setswana (tn), 2014
Azerbaijani (az), 0126	Interlingue (ie), 0905	Oromo (om), 1513	Tonga (to), 2015
Bashkir (ba), 0201	Inupiak (ik), 0911	Oriya (or), 1518	Turkish (tr), 2018
Byelorussian (be), 0205	Indonesian (in), 0914	Panjabi (pa), 1601	Tsonga (ts), 2019
Bulgarian (bg), 0207	Icelandic (is), 0919	Polish (pl), 1612	Tatar (tt), 2020
Bihari (bh), 0208	Hebrew (iw), 0923	Pashto, Pushto (ps), 1619	Twi (tw), 2023
Bislama (bi), 0209	Yiddish (ji), 1009	Quechua (qu), 1721	Ukrainian (uk), 2111
Bengali (bn), 0214	Javanese (jw), 1023	Rhaeto-Romance (rm), 1813	Urdu (ur), 2118
Tibetan (bo), 0215	Georgian (ka), 1101	Kirundi (rn), 1814	Uzbek (uz), 2126
Breton (br), 0218	Kazakh (kk), 1111	Romanian (ro), 1815	Vietnamese (vi), 2209
Catalan (ca), 0301	Greenlandic (kl), 1112	Kinyarwanda (rw), 1823	Volapük (vo), 2215
Corsican (co), 0315	Cambodian (km), 1113	Sanskrit (sa), 1901	Wolof (wo), 2315
Czech (cs), 0319	Kannada (kn), 1114	Sindhi (sd), 1904	Xhosa (xh), 2408
Welsh (cy), 0325	Kashmiri (ks), 1119	Sangho (sg), 1907	Yoruba (yo), 2515
Danish (da), 0401	Kurdish (ku), 1121	Serbo-Croatian (sh), 1908	Zulu (zu), 2621

Country code list

Country, **Country code**, **Country code letter**

Argentina, 0118, ar	Hong Kong, 0811, hk	Philippines, 1608, ph
Australia, 0121, au	India, 0914, in	Portugal, 1620, pt
Austria, 0120, at	Indonesia, 0904, id	Russian Federation, 1821, ru
Belgium, 0205, be	Italy, 0920, it	Singapore, 1907, sg
Brazil, 0218, br	Japan, 1016, jp	Spain, 0519, es
Canada, 0301, ca	Korea, Republic of, 1118, kr	Sweden, 1905, se
Chile, 0312, cl	Malaysia, 1325, my	Switzerland, 0308, ch
China, 0314, cn	Mexico, 1324, mx	Taiwan, 2023, tw
Denmark, 0411, dk	Netherlands, 1412, nl	Thailand, 2008, th
Finland, 0609, fi	New Zealand, 1426, nz	United Kingdom, 0702, gb
France, 0618, fr	Norway, 1415, no	United States of America, 2119, us
Germany, 0405, de	Pakistan, 1611, pk	

Selecting languages using the language code list

Some of the language options (such as 'DVD Language' in the Setup Navigator) allow you to set your preferred language from any of the 136 languages listed in the language code list on the previous page.

- 1 Select 'Other Language'.**
- 2 Use the ←/→ (cursor left/right) buttons to select either a code letter or a code number.**
- 3 Use the ↑/↓ (cursor up/down) buttons to select a code letter or a code number.**

See the language code list on the previous page for a complete list of languages and codes.

Glossary

Analog audio

An electrical signal that directly represents sound. Compare this to digital audio which can be an electrical signal, but is an indirect representation of sound. See also *Digital audio*.

Aspect ratio

The width of a TV screen relative to its height. Conventional TVs are 4:3 (in other words, the screen is almost square); widescreen models are 16:9 (the screen is almost twice as wide as it is high).

Digital audio

An indirect representation of sound by numbers. During recording, the sound is measured at discrete intervals (44,100 times a second for CD audio) by an analog-to-digital converter, generating a stream of numbers. On playback, a digital-to-analog converter generates an analog signal based on these numbers. See also *Sampling frequency* and *Analog audio*.

Dolby Digital



Using a maximum of 5.1 channels of audio, this high quality surround system is used in many of the finer movie theaters around the world.

The on-screen display shows which channels are active, for example showing **3/2.1**. The **3** being the two front channels and the center channel; the **2** being the surround channels, and the **.1** being the LFE channel.

DTS

DTS stands for Digital Theater System. DTS is a surround system different from Dolby Digital that has become a popular surround sound format for movies.

Dynamic range

The difference between the quietest and loudest sounds possible in an audio signal (without distorting or getting lost in noise). Dolby Digital and DTS soundtracks are capable of a very wide dynamic range, delivering dramatic cinema-like effects.

File extension

A tag added to the end of a filename to indicate the type of file. For example, ".mp3" indicates an MP3 file.

MP3

MP3 (MPEG1 audio layer 3) is a compressed audio file format. Files are recognized by their file extension ".mp3" or ".MP3".

MPEG audio

An audio format used on Video CDs and some DVD discs. This unit can convert MPEG audio to PCM format for wider compatibility with digital recorders and AV amplifiers. See also *PCM*.

MPEG video

The video format used for Video CDs and DVDs. Video CD uses the older MPEG-1 standard, while DVD uses the newer and much better quality MPEG-2 standard.

PCM (Pulse Code Modulation)

The most common system of encoding digital audio, found on CDs and DAT. Excellent quality, but requires a lot of data compared to formats such as Dolby Digital and MPEG audio. For compatibility with digital audio recorders (CD, MD and DAT) and AV amplifiers with digital inputs, this unit can convert Dolby Digital, DTS and MPEG audio to PCM. See also *Digital audio*.

PBC (PlayBack Control) (Video CD only)

A system of navigating a Video CD through on-screen menus recorded onto the disc. Especially good for discs that you would normally not watch from beginning to end all at once—karaoke discs, for example.

Regions (DVD-Video only)

These associate discs and players with particular areas of the world. This unit will only play discs that have compatible region codes. You can find the region code of your unit by looking on the rear panel. Some discs are compatible with more than one region (or all regions).

Sampling frequency

The rate at which sound is measured to be turned into digital audio data. The higher the rate, the better the sound quality, but the more digital information is generated. Standard CD audio has a sampling frequency of 44.1kHz, which means 44,100 samples (measurements) per second. See also *Digital audio*.

Setting the TV system

The default setting of this player is **AUTO**, and unless you notice that the picture is distorted when playing some discs, you should leave it set to AUTO. If you experience picture distortion with some discs, set the TV system to match your country or region's system. Doing this, however, may restrict the kinds of disc you can watch. The table below shows what kinds of disc are compatible with each setting (AUTO, PAL and NTSC).

1 If the player is on, press \odot STANDBY/ON to switch it to standby.

2 Using the front panel controls, hold down $\blacktriangleright\blacktriangleright$ then press \odot STANDBY/ON to switch the TV system.

The TV system changes as follows:

AUTO → NTSC

NTSC → PAL

PAL → AUTO

The player's display shows "Welcome Pioneer", then indicates the new setting.



Note

- You have to switch the player into standby (press \odot STANDBY/ON) before each change.

Watching NTSC on a PAL TV (MOD. PAL)

Most models of the newly developed countdown PAL TV system detect 50 Hz (PAL)/60 Hz (NTSC) and automatically switch vertical amplitude, resulting in a display without vertical shrinkage.

If your PAL TV does not have a V-Hold control, you may not be able to watch NTSC discs because of picture roll. If the TV has a V-Hold control, adjust it until the picture stops rolling.

On some TVs, the picture may shrink vertically, leaving black bands at the top and bottom of the screen. This is not a malfunction; it is caused by the NTSC to PAL conversion.

Disc		Player setting		
		NTSC	PAL	AUTO
DVD	NTSC	NTSC	MOD.PAL	NTSC
	PAL	—	PAL	PAL
Video CD	NTSC	NTSC	MOD.PAL	NTSC
	PAL	NTSC	PAL	PAL
CD / no disc	—	NTSC	PAL	NTSC or PAL

Specifications

General

System	DVD player
Power requirements	AC 220–240 V, 50/60 Hz
Power consumption	14 W
Power consumption (standby)	0.3 W
Weight	2.5 kg
Dimensions	
DV-454	420 (W) x 55 (H) x 278 (D) mm
DV-350	420 (W) x 55 (H) x 276 (D) mm
Operating temperature	+5°C to +35°C
Operating humidity	5% to 85% (no condensation)

S-Video output

Y (luminance) - Output level	1 Vp-p (75 Ω)
C (color) - Output level	286 mVp-p (75 Ω)
Jack	S-Video jack

Video output

Output level	1 Vp-p (75 Ω)
Jack	RCA jack

AV connector output

AV Connector (21-pin connector assignment)
 AV connector output 21-pin connector
 This connector provides the video and audio signals for connection to a compatible colour TV or monitor.

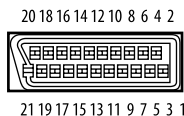

PIN no.

1	Audio 2/R out	11	G out
3	Audio 1/L out	15	R or C out
4	GND	17	GND
7	B out	19	Video out or Y out
8	Status	21	GND

Audio output (1 stereo pair)

Output level	During audio output 200 mVrms (1 kHz, –20 dB)
Number of channels	2
Jacks	RCA jack

Digital audio characteristics

Frequency response	4 Hz to 44 kHz (DVD fs: 96 kHz)
S/N ratio	118 dB
Dynamic range	101 dB
Total harmonic distortion	0.0016 %
Wow and flutter	Limit of measurement ($\pm 0.001\%$ W. PEAK) or lower

Digital output

Optical digital output (DV-454 only)	Optical digital jack
Coaxial digital output	RCA jack

Accessories

Audio/video cable	1
Power cable	1
Remote control	1
AA/R6P dry cell batteries	2
Operating Instructions	1
Warranty card	1



Note

- The specifications and design of this product are subject to change without notice, due to improvement.

Published by Pioneer Corporation.
Copyright © 2002 Pioneer Corporation.
All rights reserved.

PIONEER CORPORATION

4-1, Meguro 1-Chome, Meguro-ku, Tokyo 153-8654, Japan

PIONEER ELECTRONICS (USA) INC.

P.O. BOX 1540, Long Beach, California 90801-1540, U.S.A.

PIONEER ELECTRONICS OF CANADA, INC.

300 Allstate Parkway, Markham, Ontario L3R 0P2, Canada

PIONEER EUROPE NV

Haven 1087, Keetberglaan 1, B-9120 Melsele, Belgium TEL: 03/570.05.11

PIONEER ELECTRONICS AUSTRALIA PTY. LTD.

178-184 Boundary Road, Braeside, Victoria 3195, Australia, TEL: [03] 9586-6300

PIONEER ELECTRONICS DE MEXICO S.A. DE C.V.

San Lorenzo 1009 3er Piso Desp. 302 Col. Del Valle Mexico D.F. C.P. 03100 TEL: 55-5688-52-90

K002C_en