

User Manual	6
Manual del usuario	50
Manual do Usuário	94

**Thank you for choosing Philips.**

**Need help fast?**

*Read your Quick Use/Start Guide and/or User Manual first for quick tips that make using your Philips product more enjoyable.*

*If you have read your instructions and still need assistance, you may access our online help at [www.philips.com/support](http://www.philips.com/support)*



**PHILIPS**

México



Es necesario que lea cuidadosamente su instructivo de manejo.

	<b>PRECAUCION - ADVERTENCIA</b>	
	NO ABRIR, RIESGO DE CHOQUE ELECTRICO	
	<b>ATENCION</b>	
	VERIFIQUE QUE EL VOLTAJE DE ALIMENTACION SEA EL REQUERIDO PARA SU APARATO	
PARA EVITAR EL RIESGO DE CHOQUE ELECTRICO, NO quite LA TAPA; EN CASO DE REQUERIR SERVICIO, DIRIJASE AL PERSONAL AUTORIZADO DE PHILIPS.		

Descripción: **Reproductor de Disco de Video Digital**  
Modelo: **HTS3107/ 55**  
Alimentación: **120~127V/220~240V; 50~60Hz**  
Consumo: **150W**  
Importador: **Philips Mexicana, S.A. de C.V.**  
Domicilio: **Av. La Palma No. 6,  
Col. San Fernando, La Herradura  
Huixquilucan, Edo de Mexico  
C.P. 52784, Mexico**  
Localidad y Tel.: **Tel. 52 69 90 00**  
Exportador: **Philips Electronics HK, Ltd.**  
País de Origen: **China**  
Nº de Serie: \_\_\_\_\_

**LEA CUIDADOSAMENTE ESTE INSTRUCTIVO  
ANTES DE USAR SU APARATO.**

## **AVISO IMPORTANTE**

*Philips Mexicana, S.A. de C.V. no se hace responsable por daños o desperfectos causados por:*

- Maltrato, descuido o mal uso, presencia de insectos o roedores (cucarachas, ratones etc.).*
- Cuando el aparato no haya sido operado de acuerdo con el instructivo del uso, fuera de los valores nominales y tolerancias de las tensiones (voltaje), frecuencia (ciclaje) de alimentación eléctrica y las características que deben reunir las instalaciones auxiliares.*
- Por fenómenos naturales tales como: temblores, inundaciones, incendios, descargas eléctricas, rayos etc. o delitos causados por terceros (choques asaltos, riñas, etc.).*

## LASER

Type	Semiconductor laser GaAlAs
Wave length	650 - 660 nm (DVD) 784 - 796 nm (CD)
Output Power	7 mW (DVD) 10 mW (VCD/CD)
Beam divergence	60 degrees

Due to the inconsistency of disc formats provided by various disc manufacturers, your DVD system/ player/recorder may require a playability enhancement or upgrade. As DVD technology advances, these enhancement will become common and will be easy to complete. Go to [www.philips.com/support](http://www.philips.com/support) for software upgrade.

'CONSUMERS SHOULD NOTE THAT NOT ALL HIGH DEFINITION TELEVISION SETS ARE FULLY COMPATIBLE WITH THIS PRODUCT AND MAY CAUSE ARTIFACTS TO BE DISPLAYED IN THE PICTURE. IN CASE OF 525 OR 625 PROGRESSIVE SCAN PICTURE PROBLEMS, IT IS RECOMMENDED THAT THE USER SWITCH THE CONNECTION TO THE 'STANDARD DEFINITION' OUTPUT. IF THERE ARE QUESTIONS REGARDING OUR TV SET COMPATIBILITY WITH THIS MODEL 525p AND 625p DVD PLAYER, PLEASE CONTACT OUR CUSTOMER SERVICE CENTER.'

## CAUTION

*Use of controls or adjustments or performance of procedures other than herein may result in hazardous radiation exposure or other unsafe operation.*

## ATTENTION!

For Customer Use:

Read carefully the information located at the bottom or rear of your DVD Home Theatre System and enter below the Serial No. Retain this information for future reference.

Model No. HTS3107

Serial No. \_\_\_\_\_



Manufactured under license from Dolby Laboratories, "Dolby", "Pro Logic" and the double-D symbol are trademarks of Dolby Laboratories.



Manufactured under license from Digital Theater Systems, Inc. U.S. Pat. Nois. 5,451,942; 5,956,674; 5,974,380; 5,978,762; 6,226,616; 6,487,535 and other U.S. and world-wide patents issued and pending. "DTS" and "DTS Digital Surround" are registered trademarks of Digital Theater Systems, Inc. Copyright 1996, 2003 Digital Inc. All Rights Reserved.



DivX Ultra Certified products: "DivX, DivX Ultra Certified, and associated logos are trademarks of DivX, Inc. and are used under license.



Windows Media and the Windows logo are trademarks, or registered trademarks of Microsoft Corporation in the United States and/or other countries.

# Language Code

Abkhazian	6566	Inupiaq	7375	Pushto	8083
Afar	6565	Irish	7165	Russian	8285
Afrikaans	6570	Íslenska	7383	Quechua	8185
Amharic	6577	Italiano	7384	Raeto-Romance	8277
Arabic	6582	Ivrit	7269	Romanian	8279
Armenian	7289	Japanese	7465	Rundi	8278
Assamese	6583	Javanese	7486	Samoan	8377
Avestan	6569	Kalaallisut	7576	Sango	8371
Aymara	6589	Kannada	7578	Sanskrit	8365
Azerhijani	6590	Kashmiri	7583	Sardinian	8367
Bahasa Melayu	7783	Kazakh	7575	Serbian	8382
Bashkir	6665	Kernewek	7587	Shona	8378
Belarusian	6669	Khmer	7577	Shqip	8381
Bengali	6678	Kinyarwanda	8287	Sindhi	8368
Bihari	6672	Kirghiz	7589	Sinhalese	8373
Bislama	6673	Komi	7586	Slovensky	8373
Bokmål, Norwegian	7866	Korean	7579	Slovenian	8376
Bosanski	6683	Kuanyama; Kwanyama	7574	Somali	8379
Brezhoneg	6682	Kurdish	7585	Sotho; Southern	8384
Bulgarian	6671	Lao	7679	South Ndebele	7882
Burmese	7789	Latina	7665	Sundanese	8385
Castellano, Español	6983	Latvian	7686	Suomi	7073
Catalán	6765	Letzeburgesch;	7666	Swahili	8387
Chamorro	6772	Limburgan; Limburger	7673	Swati	8383
Chochen	6769	Lingala	7678	Svenska	8386
Chewa; Chichewa; Nyanja	7889	Lithuanian	7684	Tagalog	8476
中文	9072	Luxembourgish;	7666	Tahitian	8489
Chuang; Zhuang	9065	Macedonian	7775	Tajik	8471
Church Slavik; Slavonic	6785	Malagasy	7771	Tamil	8465
Chuvash	6786	Magyar	7285	Tatar	8484
Corsican	6779	Malayalam	7776	Telugu	8469
Česky	6783	Maltese	7784	Thai	8472
Dansk	6865	Manx	7186	Tibetan	6679
Deutsch	6869	Maori	7773	Tigrinya	8473
Dzongkha	6890	Marathi	7782	Tonga (Tonga Islands)	8479
English	6978	Marshallese	7772	Tsonga	8483
Esperanto	6979	Moldavian	7779	Tswana	8478
Estonian	6984	Mongolian	7778	Türkçe	8482
Euskara	6985	Nauru	7865	Turkmen	8475
Ελληνικά	6976	Navaho; Navajo	7886	Twi	8487
Faroese	7079	Ndebele, North	7868	Uighur	8571
Français	7082	Ndebele, South	7882	Ukrainian	8575
Frysk	7089	Ndonga	7871	Urdu	8582
Fijian	7074	Nederlands	7876	Uzbek	8590
Gaelic; Scottish Gaelic	7168	Nepali	7869	Vietnamese	8673
Galleghan	7176	Norsk	7879	Volapuk	8679
Georgian	7565	Northern Sami	8369	Walloon	8765
Gikuyu; Kikuyu	7573	North Ndebele	7868	Welsh	6789
Guarani	7178	Norwegian Nynorsk;	7878	Wolof	8779
Gujarati	7185	Occitan; Provençal	7967	Xhosa	8872
Hausa	7265	Old Bulgarian; Old Slavonic	6785	Yiddish	8973
Herero	7290	Oriya	7982	Yoruba	8979
Hindi	7273	Oromo	7977	Zulu	9085
Hiri Motu	7279	Ossetian; Ossetic	7983		
Hrvatski	6779	Pali	8073		
Ido	7379	Panjabi	8065		
Interlingua (International)	7365	Persian	7065		
Interlingue	7365	Polski	8076		
Inuktitut	7385	Português	8084		

# Index

---

English----- 6

English

Español ----- 50

Español

B. Português ----- 94

B. Português

# Table of contents

## General

<b>General Information .....</b>	<b>8</b>
Setup precautions.....	8
Accessories supplied .....	8
Cleaning discs .....	8
About recycling.....	8

## Product Overview

<b>Main Unit .....</b>	<b>9</b>
<b>Remote Control.....</b>	<b>10-12</b>
Using the remote control .....	12

## Connections

<b>Basic Connections .....</b>	<b>13-16</b>
Step 1 : Placing the speakers .....	13
Step 2 : Connecting the speakers and subwoofer.....	14
Step 3 : Connecting to TV.....	15
Option 1: Using the Video (CVBS) socket .....	15
Option 2: Connecting to a Progressive Scan TV or component video input.....	15
Step 4 : Connecting the FM/MW antennas .....	16
Step 5 : Connecting the power cord .....	16
<b>Optional Connections .....</b>	<b>17</b>
Connecting audio from TV .....	17
Connecting audio from an analogue audio/video device.....	17

## Basic Setup

<b>Getting Started .....</b>	<b>18-23</b>
Step 1: Turning on the DVD system .....	18
Turning off to Eco Power standby mode.....	18
Step 2: Finding the correct viewing channel.....	18
Step 3: Setting language preferences.....	19
On-screen display (OSD) language.....	19
Audio, Subtitle and Menu language for DVD playback.....	19-20
Step 4: Setting the TV .....	20
Selecting the matching colour system .....	20-21
Setting the TV Display.....	21
Step 5: Setting up Progressive Scan feature.....	22
Step 6: Setting the speakers' channels .....	23

## Disc Playback

<b>Disc Operations .....</b>	<b>24-32</b>
Playable discs .....	24
Playing a disc .....	24
Basic playback controls.....	25
Selecting various repeat/shuffle functions .....	25
Programming disc tracks .....	26

# Table of contents

Other playback features for video discs (DVD/VCD/SVCD) .....	26
Using the Disc Menu .....	26
Viewing playback information.....	27
Resuming playback from the last stopped point .....	27
Zooming in.....	27
Changing subtitle language (DVD only) .....	27
Changing sound track language.....	28
Selecting camera angles.....	28
Playback Control (VCD only).....	28
Preview function (VCD/SVCD only).....	28
Playing an MP3/ JPEG/Window Media Audio disc .....	29
Playing a JPEG image file (slide show) .....	30
Preview function.....	30
Zoom picture .....	30
Rotating/flipping the picture .....	30
Playing MP3 music and JPEG pictures simultaneously .....	31
Playing a DivX disc .....	31
Playing a Karaoke disc.....	32
Microphone setting .....	32

## Setup Options

<b>DVD Setup Menu Options .....</b>	<b>33-39</b>
Accessing the DVD setup menu.....	33
General Setup Page.....	34
Audio Setup Page.....	35
Video Setup Page.....	36-37
Preference Setup Page .....	38-39

## Radio Tuning

<b>Tuner Operations .....</b>	<b>40-41</b>
Tuning to radio stations.....	40
Presetting radio stations .....	40
Using auto install .....	40
Using automatic preset.....	41
Using manual preset.....	41
Selecting a preset radio station.....	41
Deleting a preset radio station.....	41
Changing tuning grid.....	41

## Others

<b>Sound and Volume Controls .....</b>	<b>42</b>
Selecting surround sound.....	42
Selecting digital sound effects.....	42
Volume control .....	42
<b>Other Features .....</b>	<b>43</b>
Controlling 'Philips' TV with the remote control.....	43
Software upgrades .....	43
<b>Troubleshooting.....</b>	<b>44-45</b>
<b>Glossary .....</b>	<b>46-47</b>
<b>Specifications .....</b>	<b>48</b>

## General Information

### CAUTION!

The machine does not contain any user-serviceable parts. Please leave all maintenance work to qualified personnel.

### Setup precautions

#### Finding a suitable location

- Place the set on a flat, hard and stable surface. Do not place the set on a carpet.
- Do not position the set on top of other equipment that might heat it up (e.g., receiver or amplifier).
- Do not put anything under the set (e.g., CDs, magazines).
- Install this unit near the AC outlet where the AC power plug can be easily reached.

#### Space for ventilation

- Place the apparatus in a location with adequate ventilation to prevent internal heat build up. Allow at least 10 cm (4") clearance from the rear and the top of the set and 5 cm (2") from the left and right to prevent overheating.

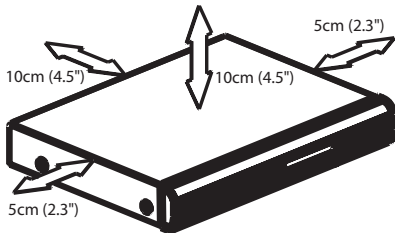

#### Avoid high temperatures, moisture, water and dust

- Apparatus must not be exposed to dripping or splashing.
- Do not place any sources of danger on the apparatus (e.g., liquid filled objects, lighted candles).

### Accessories supplied

- 1 passive subwoofer
- 4 satellite speakers
- 1 centre speaker
- 1 remote control with batteries
- 1 composite video cable (yellow)
- 1 FM wire antenna
- 1 MW loop antenna
- Quick Start Guide

### Cleaning discs

Some problems occur (frozen picture, sound disruptions, picture distortions) because the disc inside the unit is dirty. To avoid these problems, discs should be cleaned on a regular basis.

To clean a disc, use a micro fibre cleaning cloth and wipe the disc from the centre to the edge in a straight line.

### CAUTION!

Do not use solvents such as benzene, thinner, commercially available cleaners, or anti-static sprays intended for discs.

### About recycling

These operating instructions have been printed on non-polluting paper. The electronic equipment contains a large number of materials that can be recycled. If you are disposing of an old machine, please take it to a recycling centre. Please observe the local regulations regarding disposal of packaging materials, exhausted batteries and old equipment.



## Main Unit

English

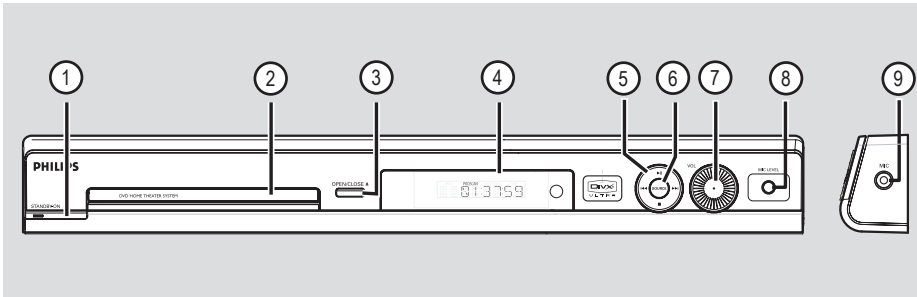

① **STANDBY ON** 

- Turns on the system or turns off to Eco Power standby mode.

② **Disc tray**

③ **OPEN CLOSE** 

- Opens/ closes the disc tray.

④ **System display panel**

⑤ **▶|| (PLAY PAUSE)**

- DISC: starts/pauses playback.
- TUNER: starts auto tuner installation for first time setup.

■ (STOP)

- Exits an operation.
- DISC: stops playback.
- TUNER: hold down this button to erase the current preset radio station.

◀◀ ▶▶

- DISC: selects a track or hold down this button to search backward/forward.
- TUNER: selects a preset radio station.

⑥ **SOURCE**

- Selects the relevant active source mode: DISC, TUNER (FM/MW), TV or AUX.

⑦ **VOL**

- Adjusts the volume level.

⑧ **MIC LEVEL**

- Activates microphone level mode and use the VOLUME control to set the microphone volume level.

⑨ **MIC**

- For connecting the microphone socket.

# Remote Control

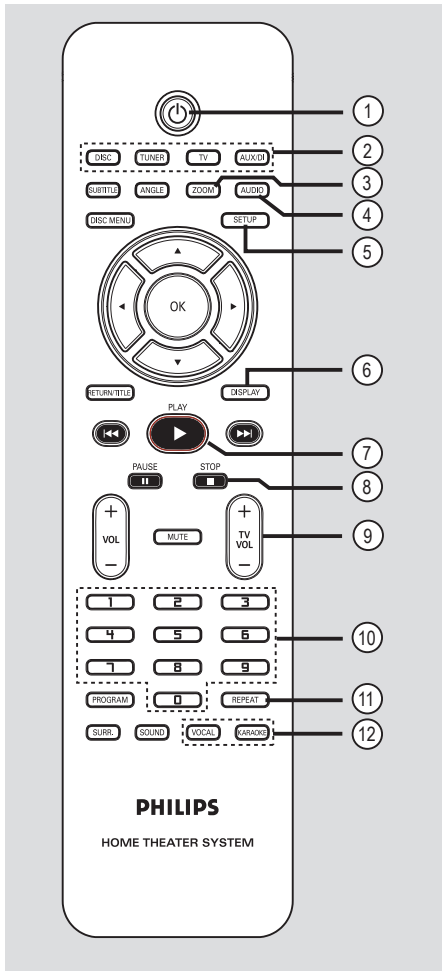

① **Power**  
– Turns off to Eco Power standby mode.

② **Source buttons**  
– **DISC**: switches to DISC mode.  
– **TUNER**: toggles between FM and MW band.  
– **TV**: switches to TV mode.  
The sound from the TV will output through the connected speakers system.  
– **AUX/DI**: switches to the external device which is connected to this DVD system.

③ **ZOOM**  
– Enlarges a picture on the TV screen.

④ **AUDIO**  
– Selects an audio language (DVD) or an audio channel (CD).

⑤ **SETUP**  
– Enters or exits the system setup menu.

⑥ **DISPLAY**  
– Displays the current status or disc information.

⑦ **PLAY ▶**  
– DISC: starts playback.

⑧ **STOP ■**  
– Exits an operation.  
– DISC: stops playback.  
– DISC: hold down this button to open and close the disc tray.  
– TUNER: hold down this button to erase the current preset radio station.

⑨ **TV VOL + –**  
– Adjusts TV volume (Philips TV only).

⑩ **Numeric Keypad (0-9)**  
– Enters a track/title number of the disc.  
– Enters a number of a preset radio station.

⑪ **REPEAT**  
– Selects various repeat modes; turns off repeat mode.

⑫ **VOCAL**  
– Toggles between various audio mode options.

**KARAOKE**  
– Enters microphone setup menu.

## Remote Control (continued)

### 13 SUBTITLE

- Selects a DVD subtitle language.

### 14 ANGLE

- Selects a DVD disc camera angle (if available).

### 15 DISC MENU

- For DVD, enter or exit disc contents menu.
- For VCD/SVCD, enter digest menu.

### 16 ◀ ▶ ▲ ▼

- DISC: selects movement direction in the menu.
- TUNER: press left or right to tune the radio frequency.
- TUNER: press up or down to start auto search.

### 17 OK

- Confirms a selection.

### 18 RETURN/TITLE

- For DVD, go back to the previous menu.
- For VCD version 2.0 only; In stop mode, turn on/off playback control (PBC) mode. During playback, display the disc title menu or return to the main menu.

### 19 ◀◀ ▶▶

- DISC: hold down this button for fast forward and backward search.
- TV: selects previous/next channel (Philips TV only).
- TUNER: selects a preset radio station.

### 20 PAUSE II

- DISC: pauses playback.

### 21 VOL + -

- Adjusts the volume level.

### 22 MUTE

- Mutes or restores the volume.

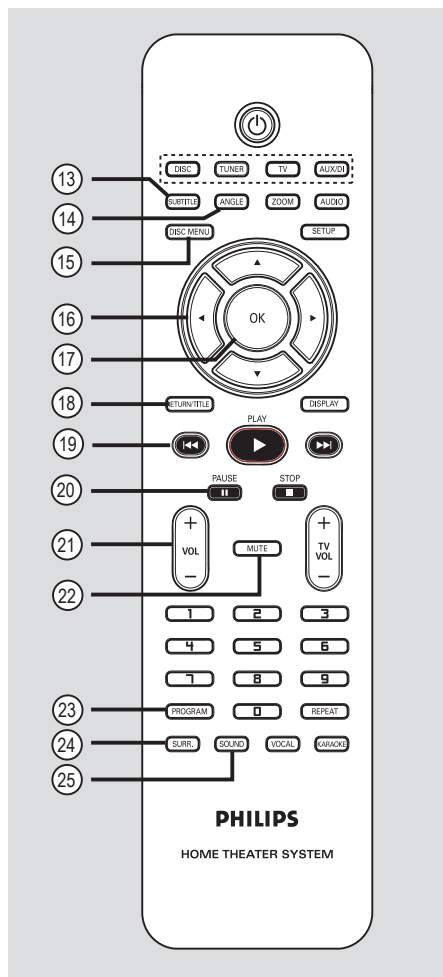

### 23 PROGRAM

- DISC: starts programming.
- TUNER: hold down this button to start automatic/ manual preset programming.

### 24 SURR.

- Selects multi-channel surround or stereo mode.

### 25 SOUND

- Selects a predefined sound effect.

## Remote Control (continued)

### Using the remote control

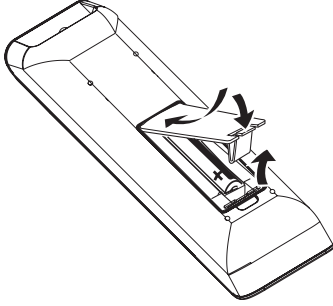

- 1 Open the battery compartment.
- 2 Insert two batteries type R03 or AAA, following the indications (+ -) inside the compartment.
- 3 Close the cover.
- 4 Point the remote control directly at the remote sensor (iR) on the front panel.

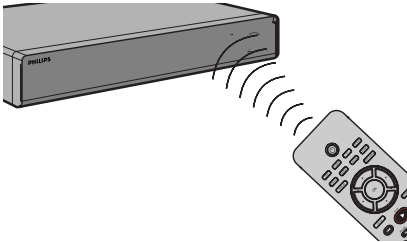

- 5 Select the source you wish to control by pressing the DISC, TUNER, TV or AUX/DI button on the remote control.
- 6 Then select the desired function (for example ◀◀, ▶▶).

### CAUTION!

- Remove batteries if they are exhausted or if the remote control is not to be used for a long time.
- Do not mix batteries (old and new or carbon and alkaline, etc.).
- Batteries contain chemical substances, so they should be disposed of properly.

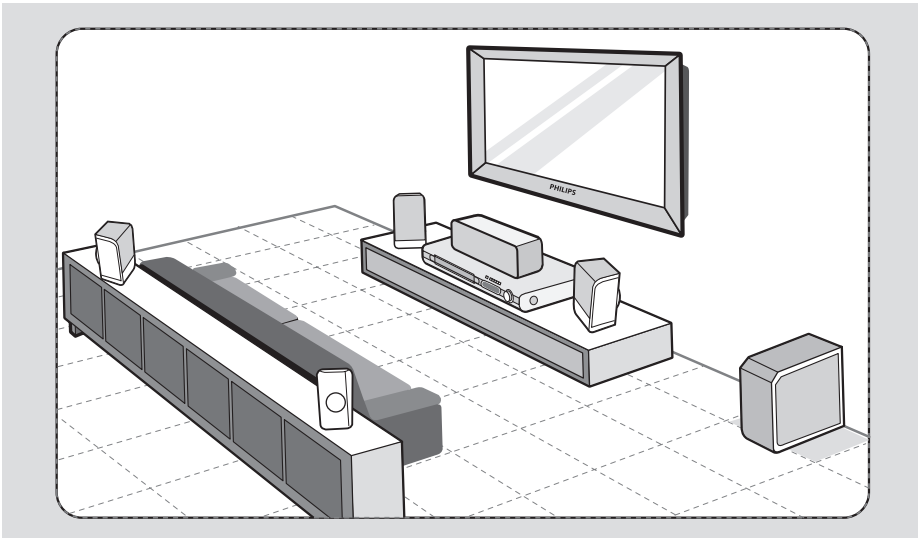

### Step 1: Placing the speakers

The Philips Home Theatre System is simple to install. However, proper system placement is critical to ensure an optimum sound experience.

- 1 Place the front left and right speakers at equal distances from the TV and at an angle of approximately 45 degrees from the listening position.
- 2 Place the centre speaker above the TV or the DVD system so that the centre channel's sound is localised.
- 3 Place the rear speakers at normal listening ear level facing each other or hang on the wall.
- 4 Place the subwoofer at the corner of the room. Keep at least one metre away from the TV.

#### Helpful Hints:

- The placement diagram shown here is only a guideline that will provide great system performance. You may find other placement choices that are more suitable for your room layout and provide the sound experience you enjoy.
- To avoid magnetic interference, do not position the front speakers too close to your TV.
- The rear speakers are labeled as REAR LEFT or REAR RIGHT.
- The front speakers are labeled as FRONT LEFT or FRONT RIGHT.

**TIPS:** Before making or changing any connections, make sure that all the devices are disconnected from the power outlet.

## Basic Connections (continued)

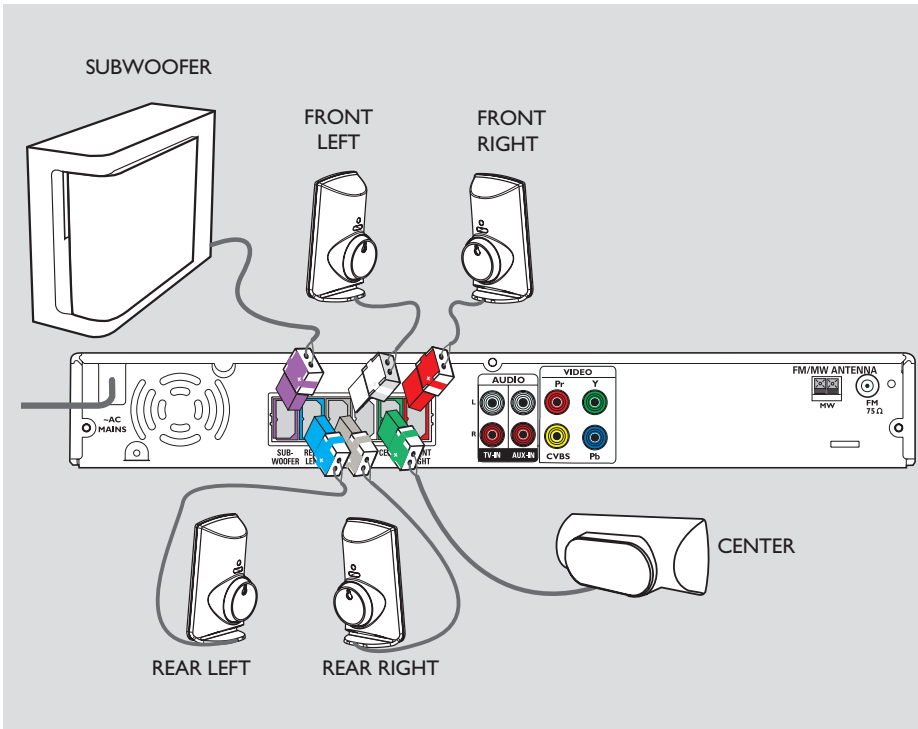

### Step 2: Connecting the speakers and subwoofer

- Connect all the speakers and subwoofer to the speaker sockets at the rear of the DVD system. Make sure that the colours of the plugs and sockets are matched.

#### Helpful Hint:

– To prevent unwanted noise, do not place the speakers too close to the DVD system, AC power adapter, TV or any other radiation sources.

**TIPS:** Before making or changing any connections, make sure that all the devices are disconnected from the power outlet.

## Basic Connections (continued)

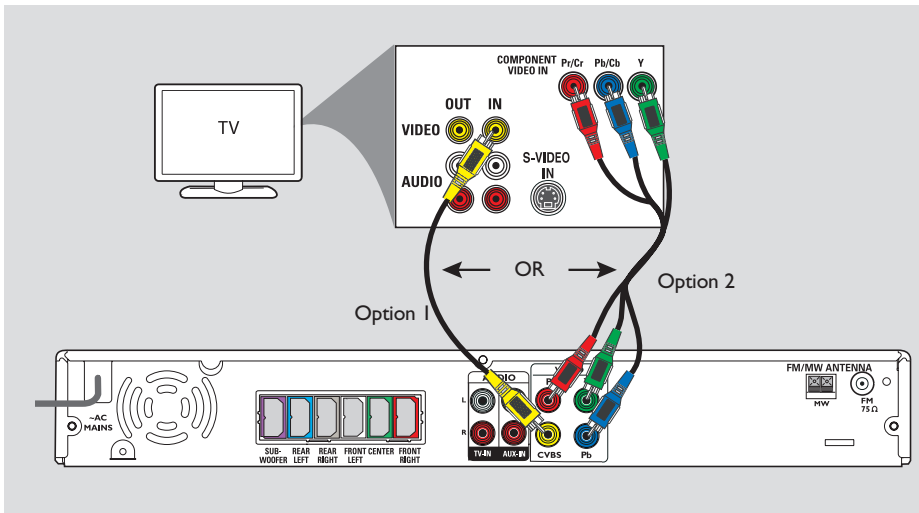

### Step 3: Connecting to TV

This connection enables you to view the playback from this DVD system. You only need to choose **one** of the options below to make your video connection.

- For a standard TV, follow option 1.
- For a progressive scan TV, follow option 2.

#### IMPORTANT!

Connect the DVD system directly to the TV.

#### Option 1: Using the Video (CVBS) socket (good picture quality)

- Use the supplied composite video cable (yellow) to connect the **CVBS** socket on the DVD system to the video input socket (or labeled as A/V In, Video In, Composite or Baseband) on the TV.

#### Option 2: Connecting to a Progressive Scan TV or component video input

The progressive scan video quality is only available when using Y Pb Pr connection and a progressive scan TV is required. It provides superior picture quality when watching DVD movies.

- 1 Follow option 1 to make the basic video connection.
- 2 Use the component video cables (red/blue/green - not supplied) to connect the **Y Pb Pr** sockets on the DVD system to the corresponding component video input sockets (or labeled as Y Pb/Cb Pr/Cr or YUV) on the TV.
- 3 If your TV accepts progressive signals, proceed to 'Getting Started - Step 5: Setting up Progressive Scan feature' for detailed progressive feature setup.

**TIPS:** Before making or changing any connections, make sure that all the devices are disconnected from the power outlet.

## Basic Connections (continued)

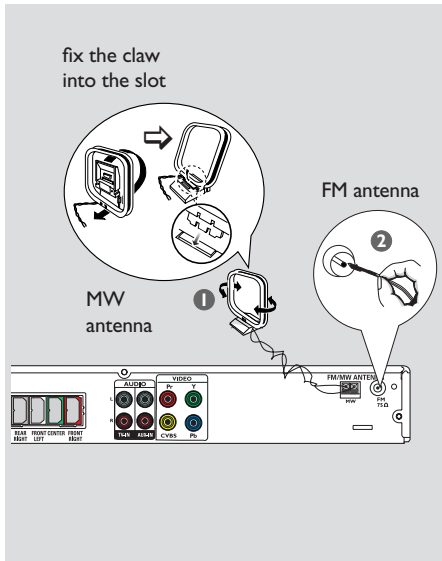

### Step 4: Connecting the FM/MW antennas

- 1 Connect the supplied MW loop antenna to the **MW** socket. Place the MW loop antenna on a shelf, or attach it to a stand or wall.
- 2 Connect the supplied FM antenna to the **FM** socket. Extend the FM antenna and fix its ends to the wall.

For better FM stereo reception, connect an external FM antenna (not supplied).

#### Helpful Hints:

- Adjust the position of the antennas for optimal reception.
- Position the antennas as far away as possible from your TV, VCR or other radiation source to prevent any unwanted interference.

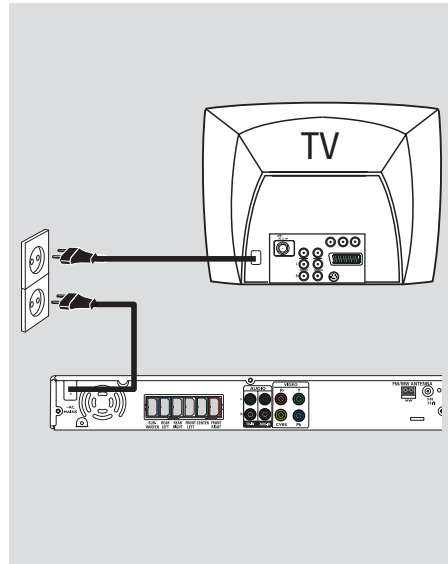

### Step 5: Connecting the power cord

**After everything is connected properly, plug the AC power cord into the power outlet.**

The Eco Power LED on the DVD system will light up. Never make or change any connections with the power turned on.

#### Helpful Hints:

- Refer to the type plate at the rear or bottom of the product for identification and supply ratings.

**TIPS:** Before making or changing any connections, make sure that all the devices are disconnected from the power outlet.



## Optional Connections

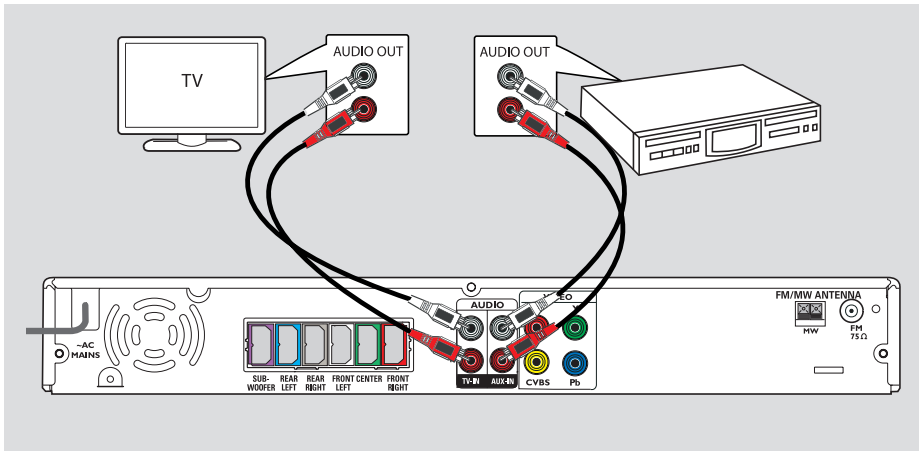

### Connecting audio from TV

When connecting the audio output from your TV to this Home Theatre Audio System, you can enjoy the multi-channel surround sound capabilities.

- Use an audio cable (red/white - not supplied) to connect the **TV IN** jacks on this DVD system to the **AUDIO OUT** sockets on the TV.

To listen to the sound, press **TV** on the remote control as the sound source that you want to play.

### Connecting audio from an analogue audio/video device

You can connect the audio output from an analogue audio/video device (e.g. VCR, Cable/Satellite Box or TV) to this Home Theatre Audio System in order to enjoy the multi-channel surround sound capabilities.

- Use an audio cable (red/white - not supplied) to connect the **AUX IN** sockets on this DVD system to the **AUDIO OUT** sockets on the connected device.

To listen to the sound, press **AUX/DI** as the sound source that you want to play.

#### Helpful Hint:

– To see the picture of the connected video device (e.g. VCR), connect the **VIDEO OUT** socket of the device to the **VIDEO IN** socket of the TV, and select the correct input channel on the TV.

**TIPS:** Refer to the respective connected device's user manual for other possible connections.

## Getting Started

### Step 1: Turning on the DVD system

- 1 Press **STANDBY ON** (⏻).
- 2 Press the **SOURCE** button on the front panel repeatedly to select :  
DISC → FM → MW → TV → AUX  
→ DISC ....

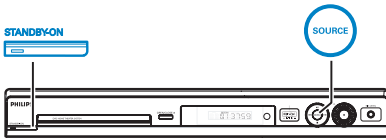

Or

- Press **DISC, TUNER, TV** or **AUX/DI** on the remote control.

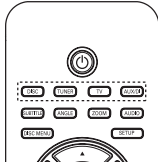

### Turning off to Eco Power standby mode

- Press **STANDBY ON** (⏻).  
→ The display screen will turn off.

### Step 2: Finding the correct viewing channel

#### Before you start ...

Make sure you have completed all the necessary connections before proceeding.

- 1 Press **SOURCE** button until "DISC" appears on the display panel.
- 2 Turn on the TV and set it to the correct video-in channel. You should see the blue DVD background screen on the TV.  
→ You may go to Channel 1 on your TV, then press the Channel Down button on your TV's remote control until you see the Video In channel.  
→ You may press **⏻** button repeatedly on your TV's remote control.  
→ Usually this channel is between the lowest and highest channels and may be called FRONT, A/V IN, VIDEO. See your TV manual for more details.

## Getting Started (continued)

### Step 3: Setting language preferences

The language options are different depending on your country or region. It may not correspond to the illustrations shown on the user manual.

#### On-screen display (OSD) language

The OSD (On-Screen Display) language for this DVD system will remain as you have set it, regardless of the changes made to the DVD disc language.

- 1 In 'DISC' mode, press **SETUP** on the remote control.  
→ { **General Setup Page** } appears.
- 2 Use ▲▼ keys to highlight { **OSD Language** }, then press ►.

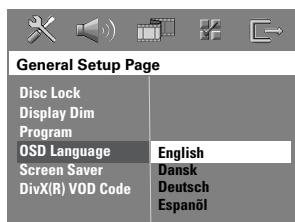

- 3 Use ▲▼ keys to select a language and press **OK** to confirm.

#### Audio, Subtitle and Menu language for DVD playback

You can select your preferred language settings for DVD playback. If the selected language is recorded on the DVD disc, the DVD system will automatically play the disc in that language. Otherwise, the disc's default language will be used instead.

- 1 Press ■ twice to stop playback (if any), then press **SETUP**.
- 2 Press ► repeatedly to select { **Preference Page** }.
- 3 Use ▲▼ keys to highlight one of the options below, then press ►.

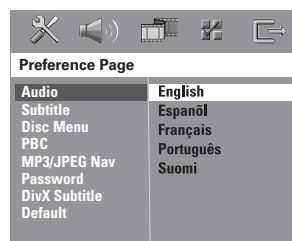

#### { **Audio** }

Selects the preferred audio language for DVD playback.

#### { **Subtitle** }

Selects the preferred subtitle language for DVD playback.

#### { **Disc Menu** }

Selects the preferred disc menu language for DVD playback.

- 4 Use ▲▼ keys to select a language and press **OK** to confirm.

**TIPS:** Press ◀ to go back to the previous menu item. Press **SETUP** to exit the menu.

## Getting Started (continued)

If the language you want is not available in the list, select { **Others** }. Use the **numeric keypad (0-9)** on the remote control to enter the 4-digit language code 'XXXX' (see page 4) and press **OK** to confirm.

- 5 Repeat steps 3 ~ 4 for other settings.

### Helpful Hints:

– During DVD playback, you can switch the audio and subtitle languages by pressing the **AUDIO** and **SUBTITLE** buttons on the remote control. However, this does not change the default settings you have made here.

– For some DVDs, the subtitle/audio/menu language can only be changed via the DVD disc menu.

## Step 4: Setting the TV

### Selecting the matching colour system

The colour system of the DVD system, DVD and TV should match. Only then will it be possible to play a DVD on this system. Before changing the TV system, determine the colour system of your TV.

- 1 In 'DISC' mode, press **SETUP** on the remote control.
- 2 Press **▶** repeatedly to select { **Video Setup Page** }.
- 3 Press **▼** to highlight { **TV Type** }, then press **▶**.

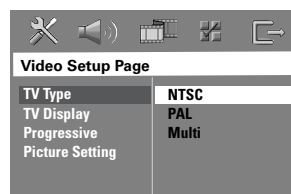

### { **PAL** }

Select this if the connected TV has the PAL colour system. It will change the video signal of an NTSC disc and output it to PAL format.

### { **NTSC** }

Select this if the connected TV has the NTSC colour system. It will change the video signal of a PAL disc and output it to NTSC format.

### { **Multi** }

Select this if the connected TV is compatible with both NTSC and PAL (multi-system). The output format will be in accordance with the video signal of the disc.

**TIPS:** The underlined option is the factory default setting.  
Press **◀** to go back to the previous menu item. Press **SETUP** to exit the menu.

## Getting Started (continued)

- 4 Select one of the options and press **OK** to confirm.  
→ Follow the instructions shown on the TV to confirm the selection (if any).  
→ If a blank/distorted TV screen appears, wait for 15 seconds for the auto recovery.

### Setting the TV Display

Set the aspect ratio of the DVD system according to the TV type you have connected. The format you select must be available on the disc. If it is not, the setting for TV display will not affect the picture during playback.

- 1 In 'DISC' mode, press **SETUP** on the remote control.
- 2 Press **▶** repeatedly to select { **Video Setup Page** }.
- 3 Press **▼** to highlight { **TV Display** }, then press **▶**.

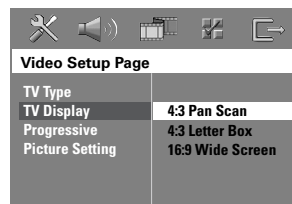

#### { **4:3 Pan Scan** }

Select this if you have a conventional TV and want both sides of the picture to be trimmed or formatted to fit your TV screen.



#### { **4:3 Letter Box** }

Select this if you have a conventional TV. In this case, a wide picture with black bands on the upper and lower portions of the TV screen will be displayed.



#### { **16:9 Wide Screen** }

Select this if you have a wide-screen TV.

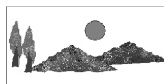

- 4 Select one of the options and press **OK** to confirm.

**TIPS:** The underlined option is the factory default setting.  
Press **◀** to go back to the previous menu item. Press **SETUP** to exit the menu.

## Getting Started (continued)

### Step 5: Setting up Progressive Scan feature

(for Progressive Scan TV only)

The progressive scan displays twice the number of frames per second than interlaced scanning (ordinary normal TV system). With nearly double the number of lines, progressive scan offers higher picture resolution and quality.

#### Before you start...

Ensure that you have connected this DVD system to a progressive scan TV using the Y Pb Pr connection (see 'Option 2: Connecting to a Progressive Scan TV or component video input').

- 1 Turn off your TV progressive scan mode or turn on to the interlaced mode (refer to your TV's user manual).
- 2 Turn on the DVD system and press **SOURCE** button until "DISC" appears on the display panel.
- 3 Turn on the TV and set it to the correct video-in channel.  
→ The blue DVD background screen will appear on the TV.
- 4 Press **SETUP** on the remote control.
- 5 Press **▶** repeatedly to select { **Video Setup Page** }.
- 6 Select { **Progressive** } > { **On**, } then press **OK** to confirm.

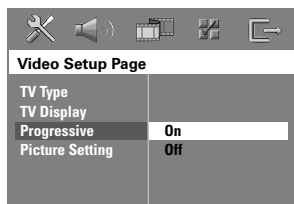

- 7 Read the notification message on the TV and confirm your action by selecting the **OK** in the menu and press **OK**.  
→ If a blank/distorted screen appears, wait for 15 seconds for the auto recovery.
- 8 Otherwise, select { **Cancel** } and press **OK** to go back to the previous menu.

**There will be no picture on your TV at this state until you have turned on the progressive scan mode on your TV.**

- 8 Turn on your TV progressive scan mode (refer to your TV's user manual).  
→ A message appears on the TV.
- 9 Confirm your action by selecting the **OK** in the menu and press **OK**.  
→ The setup is now completed and you can start to enjoy the high quality picture.

#### If no picture is displayed:

- 1 Press **OPEN CLOSE** to open the disc tray.
- 2 Press **◀** on the remote control.
- 3 Press **MUTE** on the remote control.

#### Helpful Hint:

– There are some progressive scan TVs and High-Definition TVs that are not fully compatible with this unit, resulting in an unnatural picture when playing back a DVD VIDEO disc in the progressive scan mode. In this case, turn off the progressive scan feature on both the DVD system and your TV.

**TIPS:** Press **◀** to go back to the previous menu item. Press **SETUP** to exit the menu.

## Getting Started (continued)

### Step 6: Setting the speakers' channels

You can adjust the delay times (centre and surround only) and volume level for individual speakers. These adjustments let you optimise the sound according to your surroundings and setup.

#### Before you start...

Stop the disc playback by pressing STOP button twice or remove the disc from the disc tray. Otherwise, the settings are not accessible.

- 1 In 'DISC' mode, press **SETUP** on the remote control.
- 2 Press **▶** repeatedly to select { **Audio Setup Page** }.
- 3 Press **▼** to highlight { **Speakers Volume** }, then press **▶**.



- 4 Use **◀▶** keys to set the volume level for each speaker (-6dB ~ +6dB) and press **OK** to confirm.

- 5 Use **▲▼** keys to highlight { **Speakers Delay** }, then press **▶**.

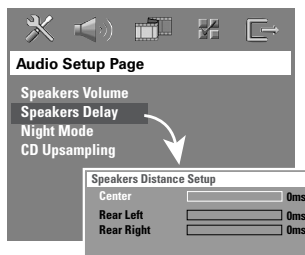

- 6 Use **◀▶** keys to set the delay times (0 ms ~ 15 ms) for centre and rear speakers that best suit your surround sound needs.
- 7 Press **OK** to confirm.

#### Helpful Hints:

- A 1ms increase/decrease of delay time is equivalent to 30 cm change in distance.
- Use the longer delay time settings when the rear speakers are closer to the listener than the front speakers.
- The test tone will be automatically generated to help you judge the sound level of each speaker.

**TIPS:** Press **◀** to go back to the previous menu item. Press **SETUP** to exit the menu.

## Disc Operations

### Playable discs



### Your DVD home theatre system will play:

- Digital Versatile Discs (DVDs)
- Video CDs (VCDs)
- Super Video CDs (SVCDs)
- Finalised DVD+Recordable (DVD±R), DVD+Rewritable (DVD±RW)
- Audio Compact Discs (CDs)
- MP3/ Windows Media™ Audio discs, picture (Kodak, JPEG) files on CD-R(W)
  - ISO 9660/UDF format
  - JPEG resolution support up to 3072 x 2048
  - Supported sampling frequencies : 32 kHz, 44.1 kHz, 48 kHz
  - Supported Bit-rates : 32~256 (kbps), variable bit rates (average 128 kbps)
- DivX files on CD-R(W)/DVD+R(W):
  - DivX 3/4/5/6, DivX Ultra
  - Supports QPEL (Quarter Pixel).

### Region Codes for DVD discs

DVD discs and players are designed with regional restrictions. Before playing a disc, make sure the disc is for the same region as your player. The regional code for this DVD system is indicated at the rear panel.

### IMPORTANT!

- If the inhibit icon (Ø or X) appears on the TV screen when a button is pressed, it means the function is not available on the current disc or at the current time.
- Do not put any objects other than discs on the disc tray. Doing so may cause the disc player to malfunction.

### Playing a disc

- 1 Press **SOURCE** repeatedly until "DISC" appears on the display panel (or press **DISC** on the remote control).
- 2 Turn on the TV to the Video In channel for the DVD system (e.g. 'EXT', '0', 'AV').  
→ You should see the blue DVD background screen on the TV.
- 3 Press **OPEN CLOSE ▲** to open the disc tray and load a disc, then press the same button again to close the disc tray.  
→ Make sure the disc label is facing up. For double-sided discs, load the side which you want to play facing up.
- You can also hold down the **STOP ■** button on the remote control to open and close the disc tray.
- 4 Playback will start automatically.  
→ See the following pages for more playback options and features.

### Helpful Hint:

- If you are having trouble playing a certain disc, remove the disc and try a different one. Improperly formatted discs will not play on this DVD system.

**TIPS:** Some discs cannot be played on this player due to the configuration and characteristics of the disc, or due to the condition of recording and authoring software that was used.



## Disc Operations (continued)

### Basic playback controls

#### Pausing playback

- During playback, press **▶||** (or **||** on the remote control).
  - While in pause mode, you can press **||** repeatedly to view the next still picture (for video playback only).
  - To resume playback, press **▶||** (or **▶▶** on the remote control).

#### Selecting another track/chapter

- Press **◀◀/ ▶▶** or use the **numeric keypad (0-9)** to key in a track/chapter number.
  - If the repeat track mode is active, press **◀◀** again to replay the same track/chapter.

#### Searching backward/forward

- Hold down **◀◀/ ▶▶**.
  - While searching, press **◀◀/ ▶▶** repeatedly to decrease/increase the search speed.
  - To resume normal playback, press **▶||** (or **▶▶** on the remote control).

#### Stopping playback

- Press **■**.

#### Helpful Hint:

– This is a power-saving feature, the system will automatically switch to Eco Power standby mode if you do not press any buttons within 30 minutes after a disc has stopped playing.

### Selecting various repeat/shuffle functions

- While playing a disc, press **REPEAT** on the remote control repeatedly to choose a repeat play mode.

#### DVD

- RPT ONE (repeat chapter)
- RPT TT (repeat title)
- SHUFFLE (random play)
- RPT SHF (repeat random play)
- RPT OFF (exit repeat mode)

#### VCD/SVCD/CD

- RPT ONE (repeat track)
- RPT ALL (repeat disc)
- SHUFFLE (random play)
- RPT SHF (repeat random play)
- RPT OFF (exit repeat mode)

#### MP3/DivX/Windows Media™ Audio

- RPT ONE (repeat track)
- RPT ALL/FLD (repeat folder)
- SHUFFLE (random play)
- RPT OFF (exit repeat mode)

#### Helpful Hint:

– Repeat playback is not possible on VCDs when the PBC mode is turned on.

**TIPS:** The operating features described here might not be possible for certain discs. Always refer to the instructions supplied with the discs.

## Disc Operations (continued)

### Programming disc tracks

(not for Picture CD/MP3)

You can play the contents of the disc in the order you want by programming the playing order of the tracks.

- 1 Press **PROGRAM** on the remote control.  
→ The programming menu appears.

Program : Track (01 - 17)		
1	04	6 __
2	10	7 __
3	11	8 __
4	__	9 __
5	__	10 __
Exit Start Next ⇨		

- 2 Use the **numeric keypad (0-9)** to enter a valid track/chapter number.
- 3 Use **◀▶▲▼** keys to move the cursor to the next position.
  - If there are more than ten total programme tracks, select { **Next** } on the screen and press **OK** (or press **▶▶** on the remote control) to access the next programming page.
  - To remove the track/chapter from the programming menu, select the track/chapter and press **OK**.
- 4 Once complete, select { **Start** } on the screen and press **OK** to start playback.  
→ Playback will start from the selected track under the programmed sequence.
- 5 To exit the programme menu, select { **Exit** } in the menu and press **OK**.

### Other playback features for video discs (DVD/VCD/SVCD)

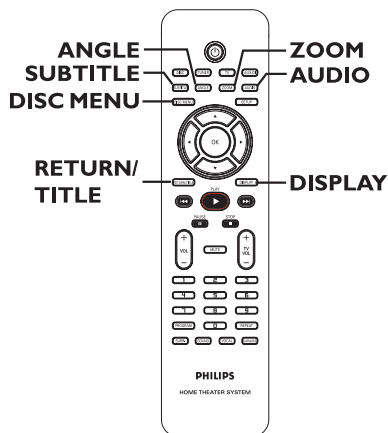

#### Using the Disc Menu

Depending on the disc format, a menu may appear on the TV screen once you load the disc.

#### To select a playback feature or item

- Use **◀▶▲▼** keys or **numeric keypad (0-9)** on the remote control, then press **OK** to start playback.

#### To access or remove the menu

- Press **DISC MENU** on the remote control.

**TIPS:** The operating features described here might not be possible for certain discs. Always refer to the instructions supplied with the discs.

## Disc Operations (continued)

### Viewing playback information

This DVD system can display the disc playback information (for example, title or chapter number, elapsed playing time, audio/subtitle language) and a number of operations can be done without interrupting disc playback.

- 1 During playback, press **DISPLAY**.  
→ A list of available disc information appears on the TV.



- 2 Use **▲▼** keys to view the information and press **OK** to access.
- 3 Use the **numeric keypad (0-9)** to input the number/time or use **▲▼** keys to make the selection, then press **OK** to confirm.  
→ Playback will change according to the chosen time or to the selected title/chapter/track.

### Resuming playback from the last stopped point

This DVD system is able to resume disc playback from its last stopped point (only possible for the last 10 discs that were recorded without a menu).

- 1 Load one of the last 10 discs played.
- 2 While "LOADING" appears on the display panel, press **PLAY ▶** (or **▶||**) to start playback from the last stop point.

### To cancel the resume mode

- Press **■** twice.

### Zooming in

This option allows you to enlarge the picture on the TV screen and to pan through the enlarged picture.

- 1 During playback, press **ZOOM** on the remote control repeatedly to select a different zoom factor.  
→ Use **◀▶▲▼** keys to move through the zoomed image.  
→ Playback will continue.
- 2 Press **ZOOM** repeatedly to return to the original size.

### Changing subtitle language (DVD only)

This operation works only on DVDs with multiple subtitle languages. You can change the language you want while playing a DVD.

- Press **SUBTITLE** repeatedly to select different subtitle languages.

**TIPS:** The operating features described here might not be possible for certain discs. Always refer to the instructions supplied with the discs.

## Disc Operations (continued)

### Changing sound track language

This operation works only on DVDs with multiple soundtrack languages, you can change the language you want while playing a DVD.

- Press **AUDIO** repeatedly to select the available audio languages.

### For VCD – changing the audio channel

- Press **AUDIO** repeatedly to select the available audio channels provided by the disc (STEREO, MONO LEFT, MONO RIGHT or MIX MONO).

### Switching camera angles

This option is only available with DVDs that contain sequences recorded from different camera angles. This allows you to view the picture from different angles.

- Press **ANGLE** repeatedly to select the available camera angles.

### Playback Control (VCD only)

Playback Control (PBC) playback allows you to play Video CDs interactively, following the menu on the display. This function can also be accessed via the 'Preference Page' menu.

### For VCDs with Playback Control (PBC) feature (version 2.0 only)

- When playback is stopped, press **RETURN/TITLE** to turn on or off the PBC mode.
- During playback, press **RETURN/TITLE** to return to the disc title menu or main menu.

### Preview function (VCD/SVCD only)

This function allows you to preview the contents of a VCD/SVCD.

- 1 Press **DISC MENU**.

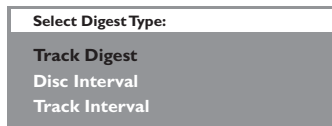

- 2 Use **▲▼** keys to select one of the following options and press **OK**.

#### { Track Digest }

View six different tracks on one screen each time. It allows you to have a quick glance at all the tracks on the disc.

#### { Disc Interval }

View the whole disc in six thumbnail pictures. It divides a disc into six portions at regular intervals and displays them on one screen.

#### { Track Interval }

View the content of a single track in six thumbnail pictures. It divides a single track into six portions at regular intervals and displays them on one screen.

This option is only available during playback mode.

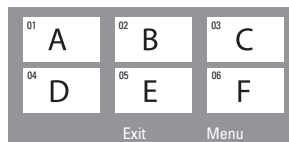

- To go to the previous or next page, press **◀◀ / ▶▶**.
  - To return to the main menu, select { **Menu** } on the screen and press **OK**.
  - Press **OK** on the selected thumbnail picture to start playback from there.
- 3 To exit the preview menu, select { **Exit** } on the screen and press **OK**.

**TIPS:** The operating features described here might not be possible for certain discs. Always refer to the instructions supplied with the discs.

## Disc Operations (continued)

### Playing an MP3/ JPEG/ Windows Media™ Audio disc

This DVD system can playback most of the MP3, JPEG and Windows Media™ Audio files recorded on a CD-R/RW disc or commercial CD.

#### Before you start ...

Turn on your TV to the correct Video In channel. See the section on 'Finding the correct viewing channel'.

- 1 Insert a disc.
  - The disc reading time may exceed 30 seconds due to the complexity of the directory/file configuration.
  - The disc menu appears on the TV.

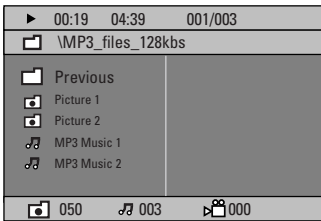

- 2 If the disc main menu contains various folders, use ▲▼ keys to select a desired folder and press **OK** to open the folder.
- 3 Use ▲▼ keys to select a track/file and press **OK** to start playback.
  - Playback will start from the selected file and continue through to the end of the folder.

During playback, you can;

- Press **◀◀/▶▶** to playback another track/file in the current folder.
- Hold down **◀◀/▶▶** to fast reverse/forward search for a music track.
- To select another folder from the current disc, press **▲** to return to the root menu. Use **▲▼** keys to make your selection and press **OK** to confirm.
- Press **REPEAT** repeatedly to access various play modes.
- 4 To stop playback, press **■**.

#### Helpful Hint:

– To skip the folders menu when you load a MP3/JPEG disc, set the MP3/JPEG NAV setting in the Preference Setup Page to { Without Menu }.

**TIPS:** Some discs cannot be played on this player due to the configuration and characteristics of the disc, or due to the condition of recording and authoring software that was used.

## Disc Operations (continued)

### Playing a JPEG image file (slide show)

#### Before you start ...

Turn on your TV to the correct Video In channel. See the section on 'Finding the correct viewing channel'.

- Insert a Picture disc (Kodak Picture CD, JPEG).
  - For a Kodak disc, the slide show will begin automatically.
  - For a JPEG disc, the picture menu will appear on the TV. Press **PLAY** ► (or ►||) to start the slide-show playback.

#### Preview function

- 1 During playback, press ■.
  - 12 thumbnail pictures will be displayed on the TV.



- 2 Press ◀◀/ ▶▶ to display the other pictures on the previous/next page.
- 3 Use ◀▶▲▼ keys to highlight one of the pictures and press **OK** to start playback.
- 4 Press **DISC MENU** to return to Picture CD menu.

#### Zoom picture

- 1 During playback, press **ZOOM** repeatedly to select a different zoom factor.
- 2 Use ◀▶▲▼ keys to pan through the zoomed image.

#### Helpful Hint:

– This feature is not applicable for DivX disc.

#### Rotating/flipping the picture

- During playback, use ◀▶▲▼ keys to rotate/flip the picture on the TV.
  - ▲ : flip the picture vertically
  - ▼ : flip the picture horizontally
  - ◀ : rotate the picture anti-clockwise
  - ▶ : rotate the picture clockwise

#### Supported file format:

- The file extension has to be '\*.JPG' and not '\*.JPEG'.
- It can only display DCF-standard still pictures or JPEG pictures e.g. TIFF. It cannot play back moving pictures, Motion JPEG, Progressive JPEG and other formats, or pictures in formats other than JPEG, or pictures associated with sound.
- It may require longer time for the DVD system to display the disc content on the TV due to the large number of songs/pictures compiled into one disc.

**TIPS:** Some discs cannot be played on this player due to the configuration and characteristics of the disc, or due to the condition of recording and authoring software that was used.

## Disc Operations (continued)

### Playing MP3 music and JPEG pictures simultaneously

You can create a musical slide show if the disc contains both the MP3 music and JPEG picture files.

- 1 Insert an MP3 disc that contains music and pictures.
- 2 Select an MP3 track in the menu and press **PLAY ▶** (or **▶II**) to start playback.
- 3 During MP3 music playback, use **◀▶▲▼** keys to select a picture folder from the disc menu and press **PLAY ▶** (or **▶II**).  
→ The picture files will be played back through to the end of the folder.
- 4 To stop simultaneous playback, press **DISC MENU** and followed by **■**.

#### Helpful Hints:

- It is normal to experience an occasional “skip” while listening to your MP3 disc.
- It is normal to experience an occasional pixelation during MP3/DivX playback due to poor clarity of digital contents during internet downloading.
- Only the first session of a multi-session CD will be played back.

### Playing a DivX disc

This DVD system supports the playback of DivX movies which you can copy from your computer onto a CD-R/RW, DVD+R/+RW disc (see ‘General Setup Page - { DivX(R) VOD code }).

- 1 Insert a DivX disc.
- 2 If the DivX movie contains external subtitles, the subtitle menu will appear on the TV for your selection.
- In this case, pressing **SUBTITLE** on the remote control will turn the subtitle display on or off.
- 3 Press **PLAY ▶** (or **▶II**) to start playback.

During playback, you can;

- If multilingual subtitles are embedded on the DivX disc, you can press **SUBTITLE** to change the subtitle language while playing.
- Use **◀ / ▶** keys on the remote control to perform fast reverse/forward search.
- Press **DISPLAY** repeatedly until the Time Search menu appears, key in the time where playback should start and press **OK** to confirm.  
→ Playback skips to the time entered.

#### Helpful Hints:

- Subtitle files with the following file name extensions (.srt, .smi, .sub, .ssa, .ass) are supported but do not appear on the file navigation menu.
- The subtitle file name has to be the same as the file name of the movie.
- The subtitle can only be displayed up to an average of 45 characters.

**TIPS:** Some discs cannot be played on this player due to the configuration and characteristics of the disc, or due to the condition of recording and authoring software that was used.

## Disc Operations (continued)

### Playing a Karaoke disc

#### Before you start ...

Turn on your TV to the correct Video In channel. See the section on 'Finding the correct viewing channel'.

- 1 Connect a microphone (not supplied) to the **MIC** socket on the side panel of the DVD main unit (as shown below).

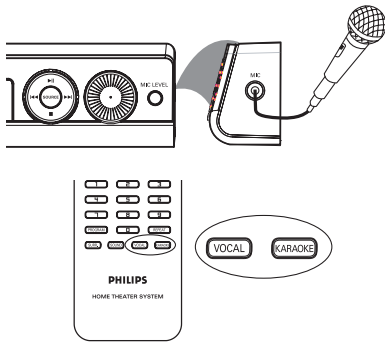

- 2 Insert a karaoke disc.  
→ If the disc menu appears, use ▲▼ keys to make your selection and press **OK** to start playback.
  - 3 To turn off the vocal or change the sound channel of a karaoke disc, press **VOCAL** on the remote control repeatedly to toggle between various audio modes.
  - 4 Start enjoying the karaoke.
- While singing, you can set the microphone volume level by pressing the **MIC LEVEL** on the front panel followed by adjusting the Volume control.

### Microphone setting

- 1 Press **KARAOKE** on the remote control to access 'Microphone Setup' page.

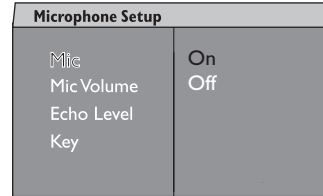

- 2 In 'Microphone Setup' page, use ▲▼ keys to select the option for microphone settings and press **OK** to confirm.

#### { Mic }

– Use ▲▼ keys to turn on or off the karaoke microphone.

#### { Mic Volume }

– Use ▲▼ keys to set the microphone volume level (00 ~ +20). Select '00' for minimum microphone volume setting.

#### { Echo Level }

– Use ▲▼ keys to set the Echo Level (00 ~ +20). Select '00' for minimum echo level setting.

#### { Key }

– Use ▲▼ keys to set the pitch level (-10~ +10) that matching your voice. Select '-10' for lowest possible tone and '+10' for highest tone. To return to original tone, select '00'.

**TIPS:** Some discs cannot be played on this player due to the configuration and characteristics of the disc, or due to the condition of recording and authoring software that was used.



# DVD Setup Menu Options

## Accessing the DVD setup menu

This DVD system setup is carried out via the TV, enabling you to customise the DVD system to suit your particular requirements.

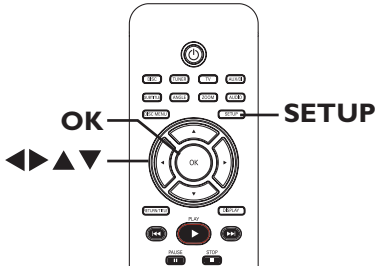

- 1 In 'DISC' mode, press **SETUP** on the remote control.  
→ The setup menu appears.
- 2 Use ◀ ▶ keys to select one of the setup menu pages and press **OK**.



- If you are not able to access the { Preference Page }, press **SETUP** to exit the menu. Then, press **STOP** (■) twice before you press the **SETUP** again.

- 3 Use ▲ ▼ keys to select a setup option and press ▶ to access
- 4 Select the setting you wish to change and press **OK** to confirm and go back to the previously selected item.  
→ Instructions and explanations of the options are provided in the following pages.  
→ If the option in the menu is greyed out, that means the setting is not available or cannot be changed in the current state.

- 5 To exit, press **SETUP**.

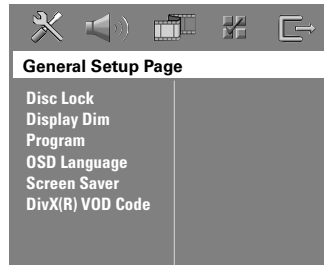

see page 34

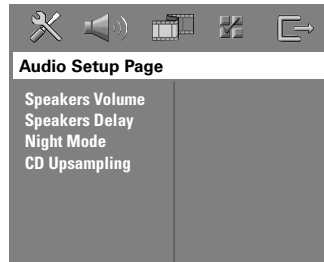

see page 35

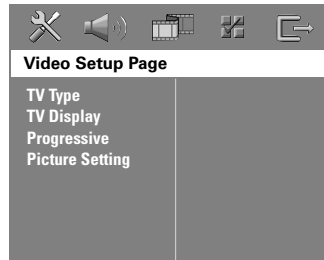

see page 36~37

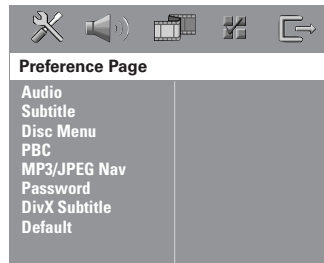

see pages 38~39

## DVD Setup Menu Options (continued)

### General Setup Page (underlined options are the factory default settings)

<b>Disc Lock</b>	<p>Not all discs are rated or coded by the disc maker. You can prevent a specific disc from playing by locking the disc. Up to 40 discs can be locked.</p> <p>{ <b>Lock</b> } – Selects this to block the playback of the current disc. Subsequent access to a locked disc requires a six-digit password. The default password is '136900' (see 'Preference Setup Page - { Password }').</p> <p>{ <b>Unlock</b> } – All discs can be played.</p>
<b>Display Dim</b>	<p>Selects the brightness of the DVD system display panel.</p> <p>{ <b>100%</b> } – Full brightness.</p> <p>{ <b>70%</b> } – Medium brightness.</p> <p>{ <b>40%</b> } – Dimmest display.</p>
<b>Program</b>	<p>Access the track programming menu. See 'Programming disc tracks' chapter.</p>
<b>OSD language</b>	<p>Selects the preferred language for the DVD system on-screen display menu.</p>
<b>Screen Saver</b>	<p>The screen saver prevents damage to the TV screen by avoiding exposure to a static image for too long.</p> <p>{ <b>On</b> } – Switches to TV screen saver mode when playback has been stopped or paused for more than 15 minutes.</p> <p>{ <b>Off</b> } – Turns off the screen saver function.</p>
<b>DivX(R) VOD code</b>	<p>Philips provides you with the DivX<sup>®</sup> VOD (Video On Demand) registration code that allows you to rent and purchase videos using the DivX<sup>®</sup> VOD service. Press ► to see the registration code and press <b>OK</b> to exit.</p> <p>Use the registration code to purchase or rent the videos from DivX<sup>®</sup> VOD service at <a href="http://www.divx.com/vod">www.divx.com/vod</a>. Follow the instructions and copy the video from your computer onto a CD-R/RW disc for playback on this DVD system.</p> <p><b>Note:</b> All the downloaded videos from DivX<sup>®</sup> VOD can only be played back on this DVD system. For more information, visit us at <a href="http://www.divx.com/vod">www.divx.com/vod</a>.</p>

## DVD Setup Menu Options (continued)

### **Audio Setup Page** (underlined options are the factory default settings)

**Speakers Volume** Access the speaker's level setup menu. Use ◀ ▶ keys to adjust the volume level for each connected speaker between -6dB to +6dB.

**Speakers Delay** Access the speaker's distance setup menu. Use ◀ ▶ keys to set the delay times for the centre and rear speakers based on the listening position and distance.

**Note:** 1 ms increase/decrease of delay time is equivalent to 30 cm change in distance. Use the longer delay time settings when the rear speakers are closer to the listener than the front speakers.

**Night Mode** This mode optimises playback of sound at low volume. High volume outputs will be softened and low volume outputs will be enhanced to an audible level. This feature is only applicable for DVD video discs with Dolby Digital mode.

- { **On** } – Turns on night mode.
- { **Off** } – Turns off night mode feature. Selects this to enjoy the surround sound with its full dynamic range.

**CD Upsampling** This feature enables you to convert your music CD to a higher sampling rate using sophisticated digital signal processing for better sound quality. If you have activated the CD upsampling feature, the system will automatically switch to stereo mode.

- { **Off** } – Turns off CD-upsampling.
- { **88.2 kHz (X2)** } – Select this to convert the sampling rate of the CDs twice as high as the original rate.

**Note:** If you press the SURR button on the remote control to select multi-channel mode, it will turn off the CD upsampling feature.

## DVD Setup Menu Options (continued)

### Video Setup Page (underlined options are the factory default settings)

#### TV Type

Selects the colour system that matches the connected TV. It will enable playback of a different type of disc (PAL or NTSC disc) on this DVD system.

- { **PAL** } – For PAL-system TV.
- { **NTSC** } – For NTSC-system TV.
- { **Multi** } – For TV that is compatible with both PAL and NTSC.

#### TV Display

The picture shape can be adjusted to fit your TV.

{ **4:3 Letter Box** } – For a 'wide-screen' display with black bars on the top and bottom.



{ 4:3 Pan Scan } – For a full-height picture with the sides trimmed.



{ **16:9 Wide Screen** } – For wide-screen TV (frame ratio 16:9).



#### Progressive

Before enabling the progressive scan feature, you must ensure that your TV can accept progressive signals (a progressive scan TV is required) and that you have connected this DVD system to your TV using the Y Pb Pr (see 'Option 2: Connecting to a Progressive Scan TV or component video input').

- { **On** } – Turns on progressive scan mode.  
Read the instructions on the TV and confirm your action by pressing **OK** on the remote control.
- { **Off** } – Disables the progressive scan mode.

**Note:** If no picture appears, wait for 15 seconds for auto recovery.

Otherwise, turn off the progressive scan as below:

- 1) Press **OPEN CLOSE** to open the disc tray.
- 2) Press **◀** on the remote control.
- 3) Press **MUTE** on the remote control.

## DVD Setup Menu Options (continued)

### **Video Setup Page** (underlined options are the factory default settings)

#### **Picture Setting**

This DVD system provides three predefined sets of picture colour settings and one personal setting which you can define yourself.

- { **Standard** } – Original colour setting.
- { **Bright** } – Vibrant colour setting.
- { **Soft** } – Warm colour setting.
- { **Personal** } – Selects this to personalise your picture colour setting. Use ◀ ▶ keys to adjust to the setting that best suits your personal preference and press **OK** to confirm. For an average setting, select { 0. }

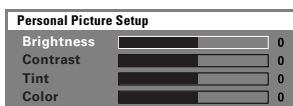

#### { **Brightness** }

Increase this value to brighten the picture colour or vice versa.

#### { **Contrast** }

Increase this value to sharpen the picture colour or vice versa.

#### { **Tint** }

Increase or decrease this value to change the colour phase of the picture.

#### { **Color** }

Increase this value to enhance the picture colour or vice versa.

## DVD Setup Menu Options (continued)

### Preference Setup Page (underlined options are the factory default settings)

<b>Audio</b>	Selects the preferred audio language for DVD playback.
<b>Subtitle</b>	Selects the preferred subtitle language for DVD playback.
<b>Disc Menu</b>	Selects the preferred disc menu language for DVD playback. <b>Note:</b> If the selected audio/subtitle/disc menu language is not available on the DVD, the disc's default language will be used instead.
<b>PBC</b>	Play Back Control feature is applicable for VCD/SVCD only. It allows you to play Video CDs (2.0) interactively, following the menu on the display. { <b>On</b> } – The index menu (if available) will appear on the TV when you load a VCD/SVCD. { <b>Off</b> } – The VCD/SVCD will skip the index menu and playback directly from the beginning.
<b>MP3/JPEG Nav</b>	MP3/JPEG Navigator can only be set if the disc is recorded with a menu. It allows you to select different display menus for easy navigation. { <b>Without Menu</b> } – Displays all the files contained in the MP3/Picture disc. { <b>With Menu</b> } – Displays the folder menu of the MP3/Picture disc. <b>Note:</b> This DVD system can only display 650 files/folder in the directory.
<b>Password</b>	The password is used for the Disc Lock. Enter your six-digit password to play a locked disc or when prompted for a password. The default password is '136900'. To change the password: 1) Press <b>OK</b> to access the change password menu. 2) Use the <b>numeric keypad 0-9</b> on the remote control to enter your existing six-digit password at { Old Password }. <b>Note:</b> When doing this for the first time or if you forget your existing password, key in '136900'. 3) Enter the new six-digit password at { New Password }. 4) Enter the new six-digit password again at { Confirm PWD }. 5) Press <b>OK</b> to confirm and exit the menu.

#### Change Password

Old Password	<input type="text"/>
New Password	<input type="text"/>
Confirm PWD	<input type="text"/>
	<input type="button" value="OK"/>

## DVD Setup Menu Options (continued)

### **Preference Setup Page** (underlined options are the factory default settings)

#### **DivX Subtitle**

Selects the font type that supports the recorded DivX subtitle.

- { **Standard** } – Displays a standard list of Roman subtitle fonts provided by this DVD system.
- { **Others** } – Displays other subtitle fonts.

#### **Default**

This feature enables you to reset all the setup menu options and your personal settings to the factory defaults, except your password for the Disc Lock. Press **OK** to confirm the default reset.

## Tuner Operations

### IMPORTANT!

Make sure the FM and MW antennas are connected.

### Tuning to radio stations

- 1 Press **SOURCE** repeatedly until "FM" appears on the display panel (or press **TUNER** on the remote control).
- 2 Press **▲ / ▼** briefly on the remote control to start tuning.  
→ "SEARCH > or <" will appear on the display panel until a radio station with sufficient signal strength is found.
- 3 Repeat step 2 if necessary until you find the desired radio station.
- 4 To fine-tune the reception of a weak station, press **◀ / ▶** briefly and repeatedly until optimal reception is found.

### Presetting radio stations

You can store up to 40 FM and 20 MW preset radio stations in the memory. There are three different ways to programme the radio stations:

- Using auto install (for first time setup only)
- Using automatic preset
- Using manual preset

#### Helpful Hints:

- The system will exit presetting mode if no button is pressed within 20 seconds.
- If no stereo signal is detected or less than 5 (five) stations are detected during tuner installation, "PLEASE CHECK ANTENNA" appears.

### Using auto install

This feature is only applicable for first time radio station programming. You will be prompted to install the radio stations when you access the tuner mode. With one touch of button, all the available radio stations will be stored automatically.

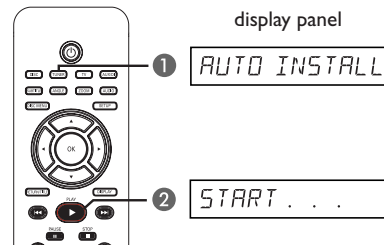

- 1 Press **TUNER**.  
→ "AUTO INSTALL PRESS PLAY" appears.
- 2 Press **PLAY ▶** until "START ..." appears on the display panel.  
→ The system will start searching from the FM band followed by the MW band.  
→ All the available radio stations with strong signal will be stored automatically.  
→ Once complete, the last tuned radio station will be played back.



## Tuner Operations (continued)

### Using automatic preset

Use automatic presetting to store or reinstall all the preset radio stations.

- 1 Press **TUNER** to select “FM” or “MW” band.
- 2 Hold down **PROGRAM** until “START ...” appears on the display panel.  
→ All previously stored radio stations will be replaced.

### Using manual preset

Use manual presetting to store your favourite radio stations.

- 1 Tune to your desired radio station (see ‘Tuning to radio stations’).
- 2 Press **PROGRAM**.
- 3 Use **◀◀/ ▶▶** keys to select a preset number that you want to store the current radio station.
- 4 Press **PROGRAM** to store.

### Selecting a preset radio station

- 1 Press **TUNER** to select “FM” or “MW” band.
- 2 Use **◀◀/ ▶▶** keys to select a preset number (or use the numeric keypad on the remote control).  
→ The waveband, preset number followed by the radio frequency will appear on the display panel.

### Deleting a preset radio station

- 1 In tuner mode, use **◀◀/ ▶▶** keys to select a preset radio station.
- 2 Hold down **■** until “FM/MW X DELETED” appears.  
→ “X” is the preset number.  
→ The radio station continues to play but has been deleted from the preset list.  
→ The rest of the preset radio stations remain unchanged.

### Changing tuning grid

(not available for all versions)

In some countries, the frequency step between adjacent channels in the MW/FM band is 9 kHz/ 50 kHz (10 kHz/ 100 kHz in some areas).

#### **IMPORTANT!**

**Changing the tuning grid will erase all previously stored preset radio stations.**

- 1 Press **SOURCE** to select “FM” or “MW”.
- 2 Press **STANDBY ON** to switch the DVD system to standby mode.
- 3 Press **STANDBY ON** and **PLAY ▶** keys together on the front panel to power up the DVD system.  
→ The display will show “GRID 9” or “GRID 10”.

*Helpful Hint:*

– GRID 9 and GRID 10 indicate that the tuning grid is in step of 9 kHz and 10 kHz respectively.

## Sound and Volume Controls

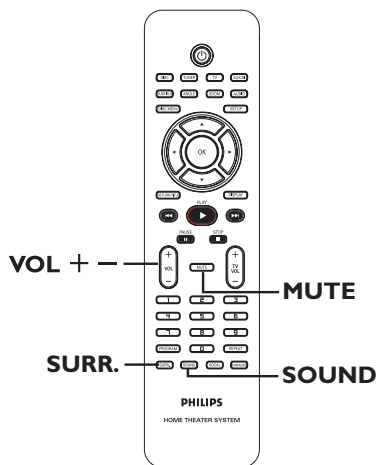

### Selecting surround sound

- Press **SURR.** to select : DOLBY+PL II (multi-channel) or STEREO.
  - The availability of the various surround sound modes depends on the sound available on the disc.
  - The centre and rear speakers operate only in multi-channel surround mode.
  - The available output modes for Multi-channel include: Dolby Digital, DTS (Digital Theatre Systems) Surround and Dolby Pro Logic II.
  - Stereo broadcasts or recordings will produce some surround channel effects when played in a surround mode. However, mono (single channel sound) sources will not produce any sound from the rear speakers.

#### Helpful Hint:

– You are not able to select the surround sound mode if the system setup menu is turned on.

### Selecting digital sound effects

Select a preset digital sound effect that matches your disc's content or that optimises the sound of the musical style you are playing.

- Press **SOUND** to select the available sound effect.

When playing movie discs or in TV mode, you can select : CONCERT, DRAMA, ACTION or SCI-FI.

When playing music discs or while in TUNER or AUX/DI mode, you can select : CLASSIC, JAZZ, ROCK or DIGITAL.

#### Helpful Hint:

– For flat sound output, select CONCERT or CLASSIC.

### Volume control

- Press **VOL +/–** on the remote control to increase or decrease the volume level.
  - “VOL MIN” is the minimum volume level and “VOL MAX” is the maximum volume level.

#### To turn off the volume temporarily

- Press **MUTE** on the remote control.
  - Playback will continue without sound and “MUTE” appears.
  - To restore the volume, press **MUTE** again, or increase the volume level.

## Other Features

### Controlling 'Philips' TV with the remote control

This DVD system's remote control enables you to control the basic functions of your 'Philips' brand TV.

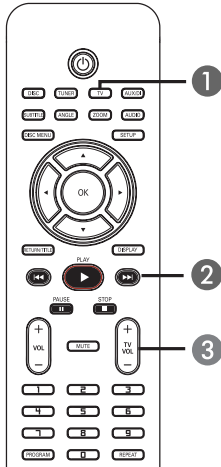

- 1 Press **SOURCE** repeatedly until "TV" appears on the display panel (or press **TV** on the remote control).
- 2 Use **◀▶** keys or the **numeric keypad (0-9)** to select the TV's channel.
- 3 Press **TV VOL +/-** to adjust the TV's volume level.

### Software upgrades

Periodically Philips will issue software upgrades to enhance your user experience.

#### Before you start ...

Check the current software version of this DVD system:

- 1) Press **OPEN CLOSE ▲** to open the disc tray.
- 2) Press **DISPLAY** on the remote control.

- 1 Visit the Philips website '[www.philips.com/support](http://www.philips.com/support)' to check the availability of the latest software upgrade. Download the software to a CD-R.
- 2 Press **OPEN CLOSE ▲** to open the disc tray.
- 3 Insert the CD-R and press **OPEN CLOSE ▲** again.  
→ The software will start to install on the recorder automatically.

#### IMPORTANT!





Power supply must not be interrupted during upgrade!

## Troubleshooting

### WARNING

Under no circumstances should you try to repair the system yourself, as this will invalidate the warranty. Do not open the system as there is a risk of electric shock.

If a fault occurs, first check the points listed below before taking the system for repair. If you are unable to solve a problem by following these instructions, consult your dealer or Philips for help.

Problem (General)	Solution
<b>No power.</b>	<ul style="list-style-type: none"> <li>– Check if the AC power cord is properly connected.</li> <li>– Press the  (STANDBY ON) on the front of the DVD system to turn on the power.</li> </ul>
<b>No picture.</b>	<ul style="list-style-type: none"> <li>– Refer to your TV's manual for correct Video In channel selection. Change the TV channel until you see the DVD screen.</li> <li>– Press the DISC button to select disc mode.</li> <li>– If this happens when you are turning on the progressive scan feature, wait for 15 seconds for the auto recovery.</li> </ul>
<b>Completely distorted picture or black/white picture.</b>	<ul style="list-style-type: none"> <li>– If this happens when you are changing the setting of the 'TV TYPE', wait for 15 seconds for the auto recovery.</li> <li>– Check the video connection.</li> <li>– Sometimes a small amount of picture distortion may appear. This is not a malfunction.</li> <li>– Clean the disc.</li> </ul>
<b>No sound or distorted sound.</b>	<ul style="list-style-type: none"> <li>– Adjust the volume.</li> <li>– Check the speaker connections and settings.</li> <li>– Make sure that the audio cables are connected and press the SOURCE button to select the correct input source (for example, TV or AUX/DI) to choose the device that you want to hear through the DVD system.</li> </ul>
<b>There is no sound from the centre and rear speakers.</b>	<ul style="list-style-type: none"> <li>– Make sure that the centre and rear speakers are connected correctly.</li> <li>– Press the SURR. button to select a correct surround sound setting.</li> <li>– Make sure that the source you are playing is recorded or broadcast in surround sound (DTS, Dolby Digital, etc.).</li> </ul>
<b>The remote control does not function properly.</b>	<ul style="list-style-type: none"> <li>– Select the source you want to play (for example, DISC or TUNER) before pressing the function button ,  / .</li> <li>– Reduce the distance between the remote control and the system.</li> <li>– Replace the batteries with new ones.</li> <li>– Point the remote control directly toward the IR sensor.</li> <li>– Check that the batteries are loaded correctly.</li> </ul>

## Troubleshooting (continued)

Problem (Playback)	Solution
<b>The DVD system does not start playback.</b>	<ul style="list-style-type: none"><li>– Insert a readable disc with the playback side facing down. The DVD+R/CD-R must be finalised.</li><li>– Check the disc type, colour system (PAL or NTSC) and region code.</li><li>– Check for any scratches or smudges on the disc.</li><li>– Press SETUP to turn off the system setup menu screen.</li><li>– You may need to enter the password in order to unlock the disc for playback.</li><li>– Moisture may have condensed inside the system. Remove the disc and leave the system turned on for about an hour.</li></ul>
<b>The aspect ratio of the screen cannot be changed even though you have set the TV display.</b>	<ul style="list-style-type: none"><li>– The aspect ratio is fixed on the DVD disc.</li><li>– Depending on the TV, it may not be possible to change the aspect ratio.</li></ul>
<b>Cannot activate some features such as Angles, Subtitles, or multi-language Audio.</b>	<ul style="list-style-type: none"><li>– The features may not be available on the DVD.</li><li>– Changing the language for the sound or subtitle is prohibited on this DVD.</li></ul>
<b>Not able to select some items in the setup/system menu.</b>	<ul style="list-style-type: none"><li>– Press STOP button twice before selecting the system setup menu.</li><li>– Depending on the disc availability, some menu items cannot be selected.</li></ul>
<b>Unable to play DivX movies.</b>	<ul style="list-style-type: none"><li>– Check that the DivX file is encoded in 'Home Theatre' mode with DivX certified encoder.</li></ul>
<b>Radio reception is poor.</b>	<ul style="list-style-type: none"><li>– If the signal is too weak, adjust the antenna or connect an external antenna for better reception.</li><li>– Increase the distance between the system and your TV or VCR.</li><li>– Tune in to the correct frequency.</li><li>– Place the antenna further away from any equipment that may be causing the interference.</li></ul>
<b>The DVD system does not work.</b>	<ul style="list-style-type: none"><li>– Disconnect the power cord from the power outlet for a few minutes. Reconnect the power cord and try to operate again as usual.</li></ul>

## Glossary

**Analogue:** Sound that has not been turned into numbers. Analogue sound varies, while digital sound has specific numerical values. These sockets send audio through two channels, the left and right.

**Aspect ratio:** The ratio of vertical and horizontal sizes of a displayed image. The horizontal vs. vertical ratio of conventional TVs is 4:3, and that of wide-screens is 16:9.

**Bit Rate:** The amount of data used to hold a given length of music; measured in kilobits per second, or kbps. Or, the speed at which you record. Generally, the higher the bit rate, or the higher the recording speed, the better the sound quality. However, higher bit rates use more space on a disc.

**Chapter:** Sections of a picture or a music piece on a DVD that are smaller than titles. A title is composed of several chapters. Each chapter is assigned a chapter number enabling you to locate the chapter you want.

**Disc menu:** A screen display prepared for allowing a selection of images, sounds, subtitles, multi-angles, etc to be recorded on a DVD.

**DivX:** The DivX code is a patent-pending, MPEG-4 based video compression technology, developed by DivXNetworks, Inc., that can shrink digital video to sizes small enough to be transported over the internet, while maintaining high visual quality.

**Dolby Digital:** A surround sound system developed by Dolby Laboratories containing up to six channels of digital audio (front left and right, surround left and right, centre and subwoofer).

**Dolby Surround Pro Logic II:** It is an improved matrix decoding technology that provides better spatiality and directionality on Dolby Surround programme material, provides a convincing three dimensional sound field on conventional stereo music recordings and is ideally suited to bring the surround experience to automotive sound. While conventional surround programming is fully compatible with Dolby Surround Pro Logic II decoders, soundtracks will be able to be encoded specifically to take full advantage of Pro Logic II playback, including separate left and right surround channels. (Such material is also compatible with conventional Pro Logic decoders).

**DTS:** Digital Theatre Systems. This is a surround sound system, but it is different from the Dolby Digital. The formats were developed by different companies.

**JPEG:** A very common digital still picture format. A still picture data compression system proposed by the Joint Photographic Expert Group, which features a small decrease in image quality in spite of its high compression ratio.

**MP3:** A file format with a sound data compression system. "MP3" is the abbreviation of Motion Picture Experts Group 1 (or MPEG-1) Audio Layer3. By using the MP3 format, one CD-R or CD-RW can contain about 10 times more data than a regular CD.

**Multichannel:** DVDs are formatted to have each sound track constitute one sound field. Multichannel refers to a structure of sound tracks having three or more channels.

**Playback control (PBC):** Refers to the signal recorded on video CDs or SVCDs for controlling playback. By using menu screens recorded on a Video CD or SVCD that supports PBC, you can enjoy interactive playback and searching.

## Glossary (continued)

**Progressive Scan:** The progressive scan displays twice the number of frames per second than in an ordinary TV system. It offers higher picture resolution and quality.

**Region code:** A system allowing discs to be played only in the region designated. This unit will only play discs that have compatible region codes. You can find the region code of your unit by looking at the product label. Some discs are compatible with more than one region (or ALL regions).

**Surround:** A system for creating realistic three dimensional sound fields full of realism by arranging multiple speakers around the listener.

**Title:** The longest section of a movie or music feature on DVD. Each title is assigned a title number, enabling you to locate the title you want.

**VIDEO OUT socket:** Yellow socket on the back of the DVD system that sends the DVD picture video to a TV.

# Specifications

## AMPLIFIER

Output power:	500 W
- Front:	75 W / channel
- Rear:	75 W / channel
- Centre:	100 W
- Subwoofer:	100 W
Frequency Response:	20 Hz – 20 kHz / –3 dB
Signal-to-Noise Ratio:	> 65 dB (CCIR)
Input Sensitivity	
- AUX In:	1000 mV

## TUNER

Tuning Range:	FM 87.5–108 MHz (50kHz) MW 531–1602 kHz (9kHz) MW 530–1700 kHz (10kHz)
26 dB Quieting	
Sensitivity:	FM 20 dB, MW 4 $\mu$ V/m
Image Rejection Ratio:	FM 25 dB, MW 28 dB
IF Rejection Ratio:	FM 60 dB, MW 45 dB
Signal-to-Noise Ratio:	FM 60 dB, MW 40 dB
AM Suppression Ratio:	FM 30 dB
Harmonic Distortion:	FM Mono 3% FM Stereo 3% MW 5%
Frequency Response:	FM 180 Hz–10 kHz / $\pm$ 6 dB
Stereo Separation:	FM 26 dB (1 kHz)
Stereo Threshold:	FM 23.5 dB

## DISC SECTION

Laser Type:	Semiconductor
Disc Diameter:	12cm / 8cm
Video Decoding:	MPEG-1 / MPEG-2 / / DivX 3/4/5/6, Ultra
Video DAC:	12 Bits
Signal System:	PAL / NTSC
Video Format :	4:3 / 16:9
Video S/N:	65 dB
Composite Video	
Output	1.0 Vp-p, 75 $\Omega$
Audio DAC:	24 Bits / 192 kHz
Frequency Response:	4 Hz–20 kHz (44.1 kHz) 4 Hz–22 kHz (48 kHz) 4 Hz–44 kHz (96 kHz)

## MAIN UNIT

Power Supply Rating:	110–127 V / 220–240 V; 50/60 Hz switchable
Power Consumption:	150 W
Eco Standby power:	< 1 W
Dimensions:	435 x 55 x 328.8 (mm) (w x h x d)
Weight:	2.94 kg

## SPEAKERS

### FRONT and REAR speakers

System:	2-way, closed box system
Impedance:	8 $\Omega$
Speaker drivers:	1 x 76mm (3") woofer
Frequency response:	120 Hz – 20 kHz
Dimensions:	97.5 x 191.3 x 71.4 (mm) (w x h x d)
Weight:	0.56 kg/each

### CENTRE speaker

System:	2-way, closed box system
Impedance:	4 $\Omega$
Speaker drivers:	1 x 76mm (3") woofer
Frequency response:	120 Hz – 20 kHz
Dimensions:	239 x 99.6 x 69.4 (mm) (w x h x d)
Weight:	0.72 kg

## SUBWOOFER

Impedance:	4 $\Omega$
Speaker drivers:	152mm (6") woofer
Frequency response:	30 Hz – 120 Hz
Dimensions:	194 x 266 x 339.5 (mm) (w x h x d)
Weight:	3.5 kg

Specifications subject to change without prior notice.



English