

Register your product and get support at

www.philips.com/welcome

DVP3556



EN User manual

PHILIPS

Contents

1	Important	4
	Safety and important notice	4
	Copyright notice	4
	Trademark notice	4
2	Your DVD player	5
	Playable media	5
	Product overview	5
3	Connect	6
	Connect audio/video cables	6
	Optional audio connections	7
	Connect USB flash drive	7
	Connect power	8
4	Get started	8
	Prepare the remote control	8
	Find the TV input channel	8
	Select menu display language	8
	Turn on progressive scan	8
5	Play	9
	Play a disc	9
	Play video	9
	Play music	11
	Play photo	11
	Play from a USB flash drive	12
6	Other features	12
	Media copy	12
	Create MP3 files	12
7	Adjust settings	13
	General setup	13
	Audio setup	14
	Video setup	15
	Preferences	15
8	Additional information	17
	Update software	17
	Care	17
	Specifications	17
9	Troubleshooting	18
10	Glossary	18

1 Important

Safety and important notice



Warning

- Risk of overheating! Never install the product in a confined space. Always leave a space of at least 4 inches around the product for ventilation. Ensure curtains or other objects never cover the ventilation slots on the product.
- Never place the product, remote control or batteries near naked flames or other heat sources, including direct sunlight.
- Avoid high temperature, moisture, water and dust.
- This unit must not be exposed to dripping or splashing.
- Never place any object or items that can damage this unit (e.g., liquid filled objects, lighted candles).
- Never place this product on other electrical equipment.
- Keep away from this product during lightning storms.
- Where the mains plug or an appliance coupler is used as the disconnect device, the disconnect device shall remain readily operable.
- Visible and invisible laser radiation when open. Avoid exposure to beam.

About Progressive Scan

Consumers should note that not all high definition television sets are fully compatible with this product and may cause artifacts to be displayed in the picture. In case of 525 or 625 progressive scan picture problems, it is recommended that the user switch the connection to the 'standard definition' output. If there are questions regarding our TV set compatibility with this model 525p and 625p DVD player, please contact our customer service center.

Disposal of your old product and batteries

Your product is designed and manufactured with high quality materials and components, which can be recycled and reused.



Never dispose of your product with other household waste. Please inform yourself about the local rules on the separate collection of electrical and electronic products and batteries. The correct disposal of these products helps prevent potentially negative consequences on the environment and human health.

Your product contains batteries, which cannot be disposed of with normal household waste. Please inform yourself about the local rules on separate collection of batteries. The correct disposal of batteries helps prevent potentially negative consequences on the environment and human health.

Please visit www.recycle.philips.com for additional information on a recycling center in your area.

Copyright notice



**Be responsible
Respect copyrights**

This item incorporates copy protection technology that is protected by U.S. patents and other intellectual property rights of Rovi Corporation. Reverse engineering and disassembly are prohibited.



Trademark notice



ABOUT DIVX VIDEO: DivX® is a digital video format created by DivX, Inc. This is an official DivX Certified device that plays DivX video. Visit www.divx.com for more information and software tools to convert your files into DivX video.

ABOUT DIVX VIDEO-ON-DEMAND: This DivX Certified® device must be registered in order to play DivX Video-on-Demand (VOD) content. To generate the registration code, locate the DivX VOD section in the device setup menu. Go to vod.divx.com with this code to complete the registration process and learn more about DivX VOD. DivX® and DivX Ultra® are registered trademarks of DivX, Inc., and are used under license.



Manufactured under license from Dolby Laboratories. Dolby and the double-D symbol are trademarks of Dolby Laboratories.



The USB-IF Logos are trademarks of Universal Serial Bus Implementers Forum, Inc.



'DVD Video' is a trademark of DVD Format/Logo Licensing Corporation.

2 Your DVD player

Congratulations on your purchase, and welcome to Philips! To fully benefit from the support that Philips offers, register your product at www.philips.com/welcome.

Playable media

This product can play:

- DVD, DVD-Video, DVD+R/+RW, DVD-R/-RW, DVD+R/-R DL (Dual Layer)
- Video CD/SVCD
- Audio CD, CD-R/CD-RW
- MP3 media, WMA media, DivX (Ultra) media, JPEG files
- USB flash drive

Region codes



You can play discs with the following region codes.

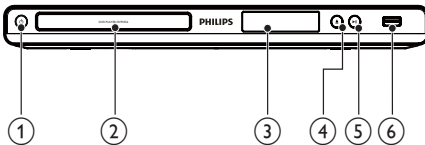

DVD region code	Countries
	India

Product overview

Main Unit





- 1  (Standby-On)
 - Turn on the unit or switch to standby.
- 2 **Disc compartment**
- 3 **Display panel**
- 4  (Open/Close)
 - Open or close the disc compartment.

- 5  (Play/Pause)
 - Start, pause or resume disc play.
- 6  (USB) jack
 - Connect a USB flash drive.

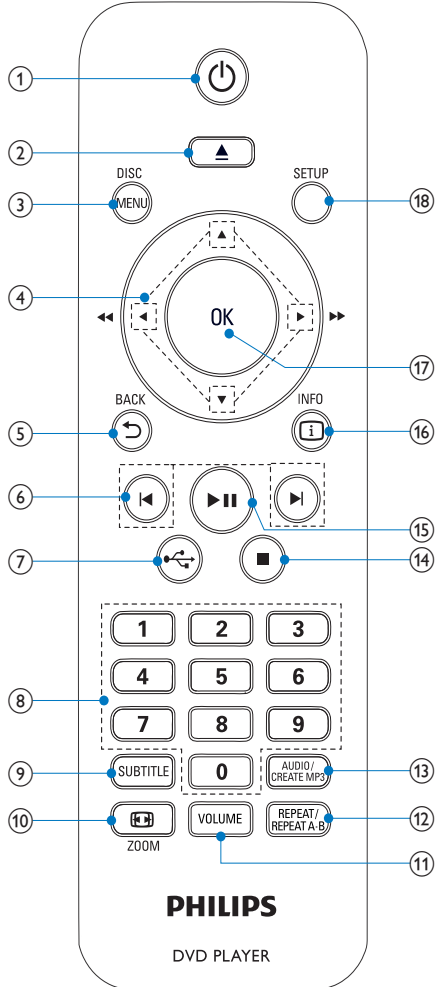
Remote control



- 1 
 - Turn on the unit or switch to standby.
- 2 
 - Open or close the disc compartment.

- ③ **DISC MENU**
- Access or exit the disc menu.
 - Switch to the disc mode.
 - During a photo slideshow, switch between Fun Mode (color) and Simple Mode (black and white).
 - For VCD and SVCD, turn on or off PBC (playback control).
- ④ **▲▼◀▶**
- Navigate the menus.
 - Search fast-forward (▶) or fast-backward (◀).
 - Search slow-forward (▲) or slow-backward (▼).
- ⑤ **↶ BACK**
- Return to the previous display menu.
- ⑥ **◀▶**
- Skip to the previous or next title, chapter, or track.
- ⑦ **↔**
- Switch to the USB mode.
- ⑧ **Numeric buttons**
- Select an item to play.
- ⑨ **SUBTITLE**
- Select a subtitle language on a disc.
 - Access the menu of copying/deleting USB audio files.
- ⑩ **📺 ZOOM**
- Fit the picture display to the TV screen.
 - Zoom the picture in or out.
- ⑪ **VOLUME**
- Display the current volume level and use (◀) or (▶) navigation buttons to set the volume level between 0 ~ 20.
- ⑫ **REPEAT/REPEAT A-B**
- Select or turn off repeat mode.
 - Repeat play for a specific section.
- ⑬ **AUDIO/CREATE MP3**
- Select an audio language or channel on a disc.
 - Access the menu of creating MP3 files.
- ⑭ **■**
- Stop play.
- ⑮ **▶||**
- Start, pause or resume disc play.
- ⑯ **ℹ INFO**
- For discs, access the play options or display the current disc status.
 - For slideshows, display a thumbnail view of photo files.

- ⑰ **OK**
- Confirm an entry or selection.
- ⑱ **SETUP**
- Access or exit the setup menu.

3 Connect

Make the following connections to use this product.

Basic connections:

- Video
- Audio

Optional connections:

- Route audio to other devices:
 - Digital amplifier/receiver
 - Analog stereo system
- USB flash drive

Connect audio/video cables

- **Option 1:** Connect to the component video jacks (for a standard TV or Progressive Scan TV).
- **Option 2:** Connect to the video (CVBS) jack (for a standard TV).

Option 1: Connect to the component video jacks

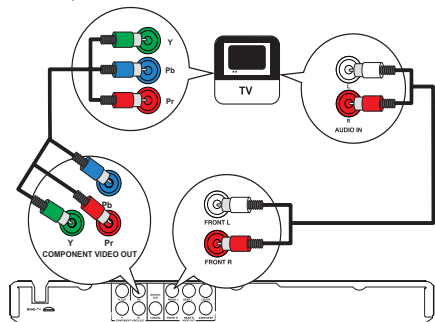

- 1 Connect the component video cables (not supplied) to:
 - the **Y Pb Pr** jacks on this product.
 - the **COMPONENT VIDEO** input jacks on the TV.
- 2 Connect the audio cables (supplied) to:
 - the **AUDIO OUT FRONT L/R** jacks on this product.
 - the audio input jacks on the TV.

Option 2: Connect to the video (CVBS) jack

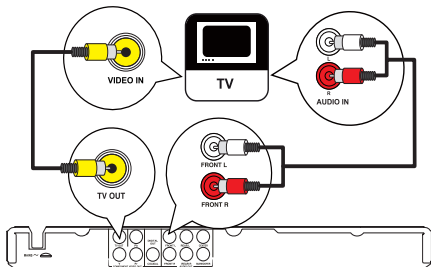

- 1 Connect a composite video cable (supplied) to:
 - the **TV OUT** jack on this product.
 - the video input jack on the TV.
- 2 Connect the audio cables (supplied) to:
 - the **AUDIO OUT FRONT L/R** jacks on this product.
 - the audio input jacks on the TV.

Optional audio connections

Connect the audio from this product to other devices to enhance sound.

Connect multi channel receiver

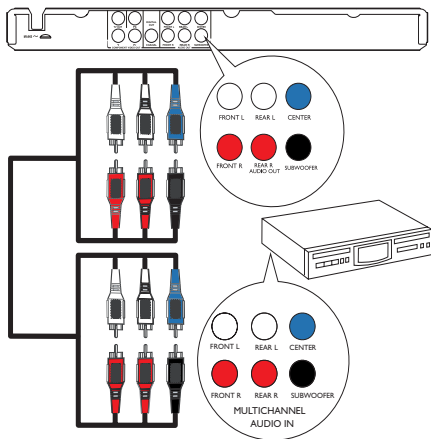

- 1 Connect the audio cables (not supplied) to:
 - the **AUDIO OUT (FRONT L/R, REAR L/R, CENTER and SUBWOOFER)** jacks on this product.
 - the audio input jacks on the device.

Connect to digital amplifier/receiver

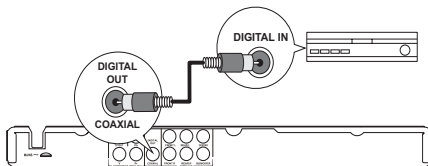

- 1 Connect a coaxial cable (not supplied) to:
 - the **COAXIAL** jack on this product.
 - the **COAXIAL/DIGITAL** input jack on the device.

Connect analogue stereo system

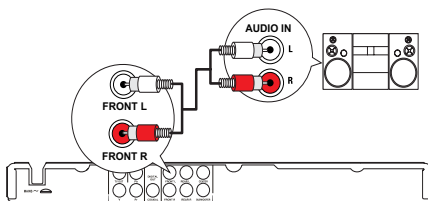

- 1 Connect the audio cables (supplied) to:
 - the **AUDIO OUT FRONT L/R** jacks on this product.
 - the audio input jacks on the TV.

Connect USB flash drive

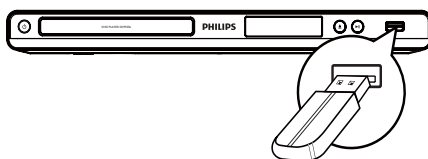

- 1 Connect a USB flash drive to the  jack on this product.

Note

- This product can only play/view MP3, WMA, DivX (Ultra) or JPEG files that are stored on a USB flash drive.
- Press the  button to access the content and play the files.

Connect power

! Caution

- Risk of product damage! Ensure that the power supply voltage corresponds to the voltage printed on the back of the product.
- Before connecting the AC power cord, ensure you have completed all other connections.

≡ Note

- The type plate is located on the back of the product.

- 1 Connect the AC power cable to the wall socket.
↳ The product is ready to be set up for use.

4 Get started

Prepare the remote control

- 1 Press and push the battery compartment to slide it open (see "1" in the illustration).
- 2 Insert two AAA batteries with correct polarity (+/-) as indicated.
- 3 Push and slide back the battery compartment (see "3" in the illustration).

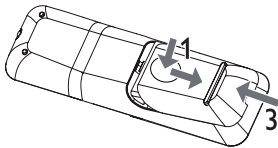





≡ Note

- If you are not going to use the remote control for a long time, remove the batteries.
- Do not mix batteries (old and new or carbon and alkaline, etc.).
- Batteries contain chemical substances, so they should be disposed of properly.

Find the TV input channel

- 1 Press \odot to turn on this product.
- 2 Turn on the TV and switch to the video input channel (refer to the TV user manual on how to select the A/V input channel).

Select menu display language





General Setup		
	Disc Lock	<input type="radio"/> English
	OSD Language	<input type="radio"/> हिंदी
	Sleep Timer	
	Auto Standby	
	DivX(R) VOD Code	

- 1 Press **SETUP**.
↳ **[General Setup]** menu is displayed.
- 2 Select **[OSD Language]**, and then press **▶**.
- 3 Press **▲▼** to select a language, and then press **OK**.

Turn on progressive scan

≡ Note

- To use the progressive scan feature, you must connect a progressive scan TV with the component video jacks (see "Connect" > "Connect audio/video cables" > "Option 1: Connect to the component video jacks" for details).

Video Setup		
	TV System	<input type="radio"/> On
	TV Display	<input type="radio"/> Off
	Progressive	
	Picture Setting	
	My Wallpaper	

- 1 Turn on the TV to the correct video input channel for this product.
- 2 Press **SETUP**.
- 3 Press **▼** to select **[Video Setup]**.
- 4 Select **[Progressive] > [On]**, and then press **OK**.
↳ A warning message is displayed.
- 5 To proceed, select **[Ok]** and then press **OK**.
↳ The progressive setup is complete.

Note

- If a blank/distorted screen is displayed, wait for 15 seconds for the auto recovery.
- If no picture is displayed, turn off the progressive scan mode as follows:
 - 1) Press **▲** to open the disc compartment.
 - 2) Press the **Numeric button '1'**.

- 6 Press **SETUP** to exit the menu.
- 7 You can now turn on the progressive scan mode on the TV (see the TV user manual).

Note

- During play, when the progressive scan mode is on for both this product and the TV, distorted picture may display. In this case, turn off the progressive scan feature on both this product and the TV.

5 Play

Play a disc

! Caution

- Do not place any objects other than discs into the disc compartment.
- Do not touch the disc optical lens inside the disc compartment.

- 1 Press **▲** to open the disc compartment.
- 2 Insert a disc with its label facing up.
- 3 Press **▲** to close the disc compartment and start disc play.

Note

- Check the types of discs supported (see "Your DVD player" > "Playable media").
- If the password entry menu is displayed, enter the password before you can play the locked or restricted disc (see "Adjust settings" > "Preferences" > **[Parental Control]**).

Play video

Note

- Some operations may not work with some discs. See the information accompanying the disc for details.

Control video play

- 1 Play a title.
- 2 Use the remote control to control the play.

Button	Action
	Start, pause or resume disc play.
	Stop disc play.
	Skip to a previous/next title or chapter.
	Search fast-backward or fast-forward. Press repeatedly to change the search speed.
	Search slow-forward or slow-backward. Press repeatedly to change the search speed. For VCD/SVCD, slow-backward search is not available.
AUDIO/CREATE MP3	Select an audio language or channel available on a disc.
SUBTITLE	Select a subtitle language available on a disc.
REPEAT/REPEAT A-B	Select or turn off repeat mode. Repeat play for a specific section.
ZOOM (Screen fit)	Fit the picture format to the TV screen. Press repeatedly until the image is scaled to fit to the TV screen.
ZOOM	Toggle between screen aspect ratio and different zoom factor. To pan through the zoomed image, press the Navigation buttons .
INFO	Access the play options and display the current disc status.

Access DVD menu

- 1 Press **DISC MENU** to access the disc root menu.
- 2 Select a play option, then press **OK**.
 - In some menus, press the **Numeric buttons** to input your selection.

Access VCD menu

The PBC (playback control) feature is available for VCD/SVCD, which can display the contents menu for you to select a play option. The PBC is on by default in the factory.

Note

- See "Adjust settings" > [Preferences] > [PBC] on how to turn PBC on or off.

- 1 Display the contents menu via one of the following ways:
 - If PBC is on, load in a VCD/SVCD.
 - During play with PBC on, press **↶** **BACK**.
- 2 Press the **Numeric buttons** to select a play option, and then press **OK** to start play.
 - If PBC is turned off, it skips the menu display and starts play from the first track.

Preview disc contents

- 1 During play, press **ⓘ** **INFO**.
 - ↳ The disc status menu is displayed.
- 2 Select **[Preview]**, and then press **▶**.
- 3 Select a preview option, and then press **OK**.
 - ↳ A thumbnails preview screen is displayed.
 - To go to the next/previous preview screen, select **[Prev]** or **[Next]**, and then press **OK**.
 - To start play, press **OK** at the selected thumbnail picture.

Skip play to a specific time

- 1 During play, press **ⓘ** **INFO**.
 - ↳ The disc status menu is displayed.
- 2 Select an option for the current elapsed playing time, and then press **▶**.
 - **[TT Time]** (title time)
 - **[CH Time]** (chapter time)
 - **[Disc Time]**
 - **[Track Time]**
- 3 Press the **Numeric buttons** to enter the time to skip to, then press **OK**.

Display play time

- 1 During play, press **ⓘ** **INFO**.
 - ↳ The disc status menu is displayed.
- 2 Select **[Time Disp.]**, and then press **▶**.
 - ↳ The display options vary from disc type.
- 3 Select an option, and then press **OK**.

View DVD play from different angles

- 1 During play, press **ⓘ** **INFO**.
 - ↳ The disc status menu is displayed.
- 2 Select **[Angle]**, and then press **▶**.
- 3 Press the **Numeric buttons** to change the angle.
 - ↳ Play changes to the selected angle.

Note

- Applicable only to discs that contain multi-angle scenes.

Repeat play for a specific section

- 1 During play, press **REPEAT/REPEAT A-B** at the start point.
- 2 Press **REPEAT/REPEAT A-B** again to set the end point.
 - ↳ Repeat play starts.
- 3 To cancel repeat play, press **REPEAT/REPEAT A-B** again.

Note

- The marked section for repeat play is only possible within a track/title.

Play DivX® (Ultra) video

DivX® (Ultra) video is a digital media format that retains high quality despite a high rate of compression. You can enjoy DivX® (Ultra) video on this DivX (Ultra) certified product.

- 1 Insert a disc or USB flash drive that contains the DivX (Ultra) videos.
 - For USB, press **↶↷**.
 - ↳ A contents menu is displayed.
- 2 Select a title to play, then press **OK**.
 - You may select subtitle/audio language.

Note

- You can only play DivX (Ultra) video that is rented or purchased with the DivX registration code of this product (see "Adjust Settings" > [General Setup] > [DivX(R) VOD Code]).

Play music

Control a track

- 1 Play a track.
- 2 Use the remote control to control the play.

Button	Action
	Start, pause or resume disc play.
	Stop disc play.
	Skip to a previous/next track.
	Select an item to play.
	Searches fast-backward or fast-forward. Press repeatedly to change the search speed.
REPEAT/ REPEAT A-B	Select or turn off repeat mode. Repeat options may vary from disc type.

Quick skip play

- 1 During play, press INFO repeatedly to select an option.

Display	Action
[Disc Go To]	Skip play to a specific time within the disc.
[Track Go To]	Skip play to a specific time within a track.
[Select Track]	Skip play to a specific track number.

- 2 Press the **numeric buttons** to change the time/number to skip to.

Play MP3/WMA music

MP3/WMA is a type of highly compressed audio file (files with .mp3, .wma extensions).

- 1 Insert a disc or USB that contains the MP3/WMA music.
 - For USB, press .
 - ↳ A contents menu is displayed.
- 2 If play does not automatically start, select a track to play.
 - To select another track/folder, press ▲▼, then press **OK**.

Note

- For disc recorded in multiple sessions, only the first session is played.
- For a WMA file that is protected by Digital Rights Management (DRM), it cannot be played on this product.
- This product does not support MP3PRO audio format.
- For any special character that is present in the MP3 track name (ID3) or album name, it might not be displayed correctly on the screen because these characters are not supported.
- Folders/files that exceed the supported limit of this product cannot be displayed or played.

Play photo

Play photo as slideshow

You can play JPEG photos (files with .jpeg or .jpg extensions).

- 1 Insert a disc or USB flash drive that contains the JPEG photos.
 - For USB, press .
 - ↳ Slideshow begins (for Kodak disc), or a contents menu (for JPEG disc) is displayed.
 - 2 Select a photo, and then press **OK** to start slideshow.
 - ↳ For a photo recorded with the "exif" format, the display orientation is automatically optimized.
- To display photos in color (fun mode) or in black and white (simple mode), press **DISC MENU**.
 - To preview the photos in thumbnail, press INFO.
 - To select a photo, press the **Navigation buttons**.
 - To enlarge the selected photo and start slideshow, press **OK**.
 - To return to the menu, press BACK.

Note

- It may require longer time to display the disc content on the TV due to the large number of songs/photos compiled onto one disc/USB flash drive.
- If the JPEG photo is not recorded with an 'exif' type file, the actual thumbnail picture cannot be shown on the screen. It is replaced by a 'blue mountain' thumbnail picture.
- This product can only display digital camera pictures according to the JPEG-EXIF format, typically used by almost all digital cameras. It cannot display Motion JPEG, or pictures in formats other than JPEG, or sound clips associated with pictures.
- Folders/files that exceed the supported limit of this product cannot be displayed or played.

Control photo play

- 1 Play a photo slideshow.
- 2 Use the remote control to control the play.

Button	Action
◀/▶	Rotate a photo anti-clockwise/ clockwise.
▲/▼	Rotate a photo horizontally/ vertically.
🔍 ZOOM	Zoom in or out of a photo. Play pauses in zoom mode.
■	Stop a play.

Play musical slideshow

Create a musical slideshow to play MP3/WMA music files and JPEG photo files simultaneously.

Note



- To create a musical slideshow, you must store the MP3/WMA and JPEG files on the same disc/USB flash drive.

- 1 Play MP3/WMA music.
 - 2 Press **BACK** to return to the main menu.
 - 3 Navigate to the photo folder/album and press **OK** to start slideshow play.
 - ↳ Slideshow begins and continues till the end of the photo folder or album.
 - ↳ Audio continues to play until the end of the disc.
 - To stop slideshow play, press **■**.
 - To stop music play, press **■** again.
-

Play from a USB flash drive

Note

- This product plays/views MP3, WMA, DivX (Ultra) or JPEG files that are stored on a USB flash drive.

- 1 Connect a USB flash drive to the  jack on this product.
- 2 Press the  button.
 - ↳ A contents menu is displayed.
- 3 If play does not start automatically, select a file to play.
 - For more information, see the chapters "Play music", "Play photo" and "Play video" for details.

- 4 To stop play, press **■**.
 - To switch to the disc mode, press the  button.

6 Other features

Media copy

You can copy files (such as MP3, WMA or JPEG) from disc to a USB flash drive.

- 1 Insert a disc that contains the MP3/WMA/JPEG files.
- 2 In the stop mode, connect the USB flash drive to the  jack on this product.
- 3 Select a file to copy, then press **SUBTITLE**.
- 4 Select **[Yes]** in the menu, then press **OK**.

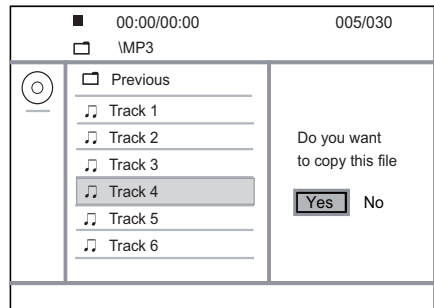

- ↳ Once complete, a new folder is created automatically in the USB flash drive to store all the new files.

- 5 To stop copy progress, press **■**, then press **OK**.

Note

- When you copy, never press any button.
- Copy-protected media cannot be copied.

Create MP3 files

With this product, you can convert audio CDs into MP3 audio files. The created MP3 audio files are saved in the USB flash drive.

- 1 Insert an audio CD.
- 2 Connect a USB flash drive to the  jack on this product.

- 3 During disc play, press **AUDIO/CREATE MP3**.
↳ The MP3 creation menu is displayed.
- 4 Select **[Yes]** in the menu, and then press **OK**.

Create MP3			
OPTIONS		TRACK	
Speed	Normal	<input type="radio"/> Track01	04:14
Bitrate	128kbps	<input type="radio"/> Track02	04:17
CRT ID3	Yes	<input type="radio"/> Track03	03:58
Device	USB 1	<input type="radio"/> Track04	04:51
SUMMARY		<input type="radio"/> Track05	03:53
Press [OK] button to change speed.		<input type="radio"/> Track06	04:09
		<input type="radio"/> Track07	04:38
Start	Exit	Select all	Deselect all

- 5 Select a conversion option in the **[OPTIONS]** panel, and then press **OK** repeatedly to select an item.

Option	Description
[Speed]	Select a copying speed.
[Bitrate]	Select a quality level. Higher bitrate for better sound quality and bigger file size.
[CRT ID3]	Copy track information into the MP3 file.
[Device]	The created files can only be saved in a USB flash drive.

- 6 Press **▶** to access the **[TRACK]** panel.
- 7 Select an audio track, and then press **OK**.
 - To select another track, repeat step 7.
 - To select all tracks, select **[Select all]** in the menu, and press **OK**.
 - To deselect all tracks, select **[Deselect all]** in the menu, and press **OK**.
- 8 Select **[Start]** in the menu, and then press **OK** to start to convert.
 - ↳ Once complete, a new folder is created automatically in the USB flash drive to store all the new MP3 files.
 - To exit the menu, select **[Exit]**, and then press **OK**.

Note





- When you convert, never press any button.
- DTS CDs and copy-protected CDs cannot be converted.
- Writer-protected or password-protected USB flash drives cannot be used to store MP3 files.

7 Adjust settings

Note

- If the setup option is grayed out, it means the setting cannot be changed at the current state.

General setup

General Setup	
	Disc Lock
	OSD Language
	Sleep Timer
	Auto Standby
	DivX(R) VOD Code

- 1 Press **SETUP**.
↳ **[General Setup]** menu is displayed.
- 2 Press **▶** to enter the submenu.
- 3 Select an option, and then press **OK**.
- 4 Select a setting, and then press **OK**.
 - To return to the previous menu, press **↶ BACK**.
 - To exit the menu, press **SETUP**.

[Disc Lock]

Set the play restriction for a disc which is loaded in the disc compartment (maximum 20 discs can be locked).

- **[Lock]** - Restrict the access to the current disc. At the next time when you want to play this disc or unlock it, you need to enter the password.
- **[Unlock]** - Play all discs.

[OSD Language]

Select a language for on-screen menu.

[Sleep Timer]

Switch automatically to standby at the preset time.

- **[Off]** - Disable sleep mode.
- **[15 Mins]**, **[30 Mins]**, **[45 Mins]**, **[60 Mins]** - Select the countdown time for this product to switch to standby.

[Auto Standby]

Turn on/off the auto standby mode.

- **[On]** - Switch to standby after 15 minutes of inactivity (for example, in pause or stop mode).
- **[Off]** - Disable the auto standby mode.

[DivX(R) VOD Code]







Display the DivX® registration code and deregistration code.

- **[Registration]** - Obtain a registration code to register this product on website.
- **[Deregistration]** - Obtain a deregistration code to cancel the registration of this product on website.

Note

- Use this product's DivX registration code when you rent or purchase video from www.divx.com/vod. The DivX videos rented or purchased through the DivX® VOD (Video On Demand) service can be played only on the device to which it is registered.

Audio setup

Audio Setup	
	Analogue Output _____
	Digital Audio _____
	Volume _____
	Sound Mode _____
	Speaker Setup _____
	CD Upsampling _____
	Night Mode _____

- 1 Press **SETUP**.
↳ **[General Setup]** menu is displayed.
- 2 Press **▼** to select **[Audio Setup]**, and then press **▶** to enter the submenu.
- 3 Select an option, and then press **OK**.
- 4 Select a setting, and then press **OK**.
 - To return to the previous menu, press **↶** **BACK**.
 - To exit the menu, press **SETUP**.

[Analogue Output]

Select an analogue setting based on the audio device that is connected through the analogue audio jack.

- **[LT/RT]** - For the surround sound output through two speakers.
- **[Stereo]** - For the stereo output.
- **[Multi Channel]** - For multi-channel output.

[Digital Audio]

Select a digital setting based on the digital amplifier/receiver that is connected through the digital jack (coaxial/digital).

- **[Digital Output]** - Select a type of digital output.
 - **[All]** - Support multi-channel audio formats.
 - **[Off]** - Disable digital output.

- **[PCM Only]** - Downmix to two-channel audio format.
- **[LPCM Output]** - Select the LPCM (Linear Pulse Code Modulation) output sampling rate.
 - **[48kHz]** - For discs recorded at sampling rate of 48 kHz.
 - **[96kHz]** - For discs recorded at sampling rate of 96 kHz.

Note

- **[LPCM Output]** setting is only available if the **[Digital Output]** is set to **[PCM Only]**.
- The higher the sampling rate, the better the sound quality.

[Volume]

Set the default volume level when you play a disc.

1. Press **OK**.
2. Press **◀▶** to set the volume.
3. Press **OK** to confirm and exit.

[Sound Mode]

Select a preset sound effect to enhance the audio output.

- **[3D]** - Select a virtual surround sound effect that is produced from the left and right audio channels.
- **[Movie Mode]** - Select a sound effect for movies.
- **[Music Mode]** - Select a sound effect for music.

[Speaker Setup]

Optimize the surround output for the connected speakers.

[CD Upsampling]

For better sound quality in stereo mode, convert the music CD to a higher sampling rate.

- **[Off]** - Turn off CD-upsampling.
- **[88.2kHz]** - Convert to twice the original sampling rate.
- **[176.4kHz]** - Convert to four times the original sampling rate.

[Night Mode]





Make loud sound level softer and soft sound level louder so that you can watch the DVD movies at a low volume, without disturbing others.

- **[On]** - Enjoy quiet viewing at night.
- **[Off]** - Enjoy surround sound with a full dynamic range.

Note

- Applicable only to Dolby Digital encoded DVDs.

Video setup

Video Setup		
	TV System	_____
	TV Display	_____
	Progressive	_____
	Picture Setting	_____
	My Wallpaper	_____

- 1 Press **SETUP**.
↳ **[General Setup]** menu is displayed.
- 2 Press **▼** to select **[Video Setup]**, and then press **▶** to enter the submenu.
- 3 Select an option, and then press **OK**.
- 4 Select a setting, and then press **OK**.
 - To return to the previous menu, press **↶ BACK**.
 - To exit the menu, press **SETUP**.

[TV System]

Change this setting if the video does not appear correctly. By default, this setting matches the most common setting for TVs in your country.

- **[PAL]** - For a PAL-system TV.
- **[Multi]** - For TV that is compatible with both PAL and NTSC.
- **[NTSC]** - For an NTSC-system TV.

[TV Display]

Select a display format:



4:3 Pan Scan (PS)

4:3 Letter Box (LB)

16:9 (Wide Screen)

- **[4:3 Pan Scan]** - For a 4:3 screen TV: full-height display with the trimmed sides.
- **[4:3 Letter Box]** - For a 4:3 screen TV: wide-screen display with black bars on the top and bottom of the screen.
- **[16:9]** - For a wide-screen TV: display ratio 16:9.

[Progressive]

If a progressive scan TV is connected to this product, turn on the progressive scan mode.

- **[On]** - Turn on progressive scan.
- **[Off]** - Turn off progressive scan mode.

Note

- For more detailed description, see "Get started" > "Turn on progressive scan".

[Picture Setting]

Select a predefined set of picture color settings or customize the personal setting.

- **[Standard]** - Original color setting.
- **[Bright]** - Vibrant color setting.
- **[Soft]** - Warm color setting.
- **[Personal]** - Customize the color setting. Set the level of brightness, contrast, tint and color saturation, then press **OK**.

[My Wallpaper]

Select a picture as the wallpaper.





- **[Default picture]** - The default wallpaper preset as the Philips logo.
- **[Saved picture]** - A captured video image or JPEG photo.
- **[Current picture]** - Capture a video image or JPEG photo and save it on the product.

1. Play a video or photo slideshow.
2. Select a video image or photo: press **▶||** to pause, and then press **SETUP**.
3. Navigate to the option (**[Video Setup]** > **[My Wallpaper]** > **[Current picture]**).
4. Press **OK** to confirm.
 - ↳ One video image or JPEG photo is saved as wallpaper.
 - ↳ A newly saved image or photo replaces the earlier one.

Preferences

Note

- Stop disc play before you can access to **[Preferences]**.

Preferences		
	Audio	_____
	Subtitle	_____
	Disc Menu	_____
	Parental Control	_____
	PBC	_____
	Mp3/Jpeg Nav	_____
	Password	_____
	DivX Subtitle	_____

- 1 Press **SETUP**.
↳ **[General Setup]** menu is displayed.
- 2 Press ▼ to select **[Preferences]**, and then press ► to enter the submenu.
- 3 Select an option, and then press **OK**.
- 4 Select a setting, and then press **OK**.
 - To return to the previous menu, press **↶ BACK**.
 - To exit the menu, press **SETUP**.

[Audio]

Select an audio language for disc play.

[Subtitle]

Select a subtitle language for disc play.

[Disc Menu]

Select a disc menu language.



Note

- If the language you have set is not available on the disc, the disc uses its own default language.
- For some DVDs, the subtitle/audio language can only change from the disc menu.
- To select the languages that are not listed in the menu, select **[Others]**. Then check the Language Code list at the back of this user manual and enter the respective language code.

[Parental Control]

Restrict access to discs that are unsuitable for children. These types of discs must be recorded with ratings.

1. Press **OK**.
2. Select a rating level, then press **OK**.
3. Press the **numeric buttons** to enter the password.



Note

- Rated DVDs above the level you set in **[Parental Control]** require a password to be played.
- The ratings are country-dependent. To allow all discs to play, select **'B'**.
- Some discs have ratings printed on them but are not recorded with ratings. This function has no effect on such discs.

[PBC]

Turn on or off the content menu of VCDs/SVCDs with PBC (playback control) feature.

- **[On]** - Display the index menu when you load a disc for play.
- **[Off]** - Skip the menu and start play from the first track.

[Mp3/Jpeg Nav]

Select to display the folders or display all the files.

- **[View Files]** - Display all the files.
- **[View Folders]** - Display the folders of MP3/WMA files.

[Password]

Set or change the password for locked discs and play restricted DVDs.

Preferences Change Password	
Old Password	<input type="text"/>
New Password	<input type="text"/>
Confirm PWD	<input type="text"/>
<input type="button" value="OK"/>	

1. Press the **Numeric buttons** to enter '136900' or the last set password at **[Old Password]** field.
2. Enter the new password at **[New Password]** field.
3. Enter the new password again at **[Confirm PWD]** field.
4. Press **OK** to exit the menu.



Note

- If you forget the password, enter '136900' before you set a new password.

[DivX Subtitle]

Select a character set that supports the DivX subtitle.

- **[Standard]** - English, Irish, Danish, Estonian, Finnish, French, German, Italian, Portuguese, Luxembourgish, Norwegian (Bokmål and Nynorsk), Spanish, Swedish, Turkish



Note

- Ensure that the subtitle file has the exact same file name as the movie file. If for example the file name of the movie is 'Movie.avi', then you need to name the text file 'Movie.sub' or 'Movie.srt'.

[Version Info]

Display the software version of this product.



Note

- This information is required when you want to find out if a newest software version is available at the Philips website that you may download and install on this product.

[Default]

Reset all the settings of this product to factory default, except for **[Disc Lock]**, **[Parental Control]** and **[Password]** settings.

8 Additional information

Update software

For software updates, check the current software version of this product to compare with the latest software (if available) at the Philips website.

**Caution**

- Power supply must not be interrupted during software upgrade.

- 1 Press **SETUP**.
- 2 Select **[Preferences]** > **[Version Info]**, and then press **OK**.
- 3 Write down the file name, and then press **SETUP** to exit the menu.
- 4 Visit www.philips.com/support to check for the latest software version, using the file name for this product.
- 5 Refer to the upgrade instructions on the website for more information.

**Note**

- Disconnect the power cord for a few seconds and connect again to turn on the product.

Care

**Caution**

- Never use solvents such as benzene, thinner, cleaners available commercially, or anti-static sprays intended for discs.

Clean discs

Wipe the disc with a micro fibre cleaning cloth from the centre to the edge in a straight line movement.

Specifications

**Note**

- Specification and design are subject to change without notice

USB

- Compatibility: Hi-Speed USB (2.0)
- Class support: UMS (USB Mass Storage Class)

Video

- Signal system: PAL / NTSC
- Composite video output: 1 Vpp ~ 75 ohm
- Component video output: 0.7 Vpp ~ 75 ohm

Audio

- Analog stereo output
- Signal to noise ratio (1 kHz): > 90 dB (A-weighted)
- Dynamic Range (1 kHz): > 80 dB (A-weighted)
- Crosstalk (1 kHz): > 80 dB
- Distortion/noise: (1 kHz): > 70 dB
- MPEG MP3: MPEG Audio L3
- Digital output
 - Coaxial

Main unit

- Dimensions (w x h x d): 360 x 39 x 209 (mm)
- Net Weight: approximately 1.45 kg

Power

- Power supply rating: 110 - 240 V, 50/60 Hz
- Power consumption: < 8 W
- Power consumption in standby mode: < 0.3 W

Accessories supplied

- Remote control and batteries
- Audio/Video cables
- User Manual

Laser specification

- Type: Semiconductor laser InGaAlP (DVD), AlGaAs (CD)
- Wave length: 656 nm (DVD), 790 nm (CD)
- Output Power: 7.0 mW (DVD), 10.0 mW (VCD/CD)
- Beam divergence: 60 degrees

9 Troubleshooting



Warning

- Risk of electric shock. Never remove the casing of the product.

To keep the warranty valid, never try to repair the product yourself.

If you have problems using this product, check the following points before you request service. If you still have a problem, register your product and get support at www.philips.com/welcome.

If you contact Philips, you will be asked for the model and serial number of your product. The model number and serial number are on the back of your product. Write the numbers here:

Model No. _____

Serial No. _____

Main unit

The buttons on this unit do not work.

- Disconnect this product from the power outlet for a few minutes, then connect again.

No reaction to the remote control.

- Connect this product to the power outlet.
- Point the remote control at the IR sensor located on the front panel of this product.
- Insert the batteries correctly.
- Insert new batteries in the remote control.

Picture

No picture.

- See the TV's user manual on how to select the correct input on the TV. Change the TV channel until you see the Philips screen.
- If you have turned on the progressive scan setting or change the TV system setting, switch back to default mode: 1) Press **▲** to open the disc compartment. 2) Press the **Numeric button '1'** (for progressive scan) or the **Numeric button '3'** (for TV system).

Sound

No audio output from the TV.

- Ensure that the audio cables are connected to the audio input of the TV.
- Assign the audio input of the TV to the corresponding video input. See the TV user manual for details.

No audio output from the loudspeakers of the audio device (stereo system/amplifier/receiver).

- Ensure that the audio cables are connected to the audio input of the audio device.
- Turn on the audio device to its correct audio input source.

No sound during DivX video playback

- The audio codec may not be supported by this product.

Play

The disc cannot be played.

- The disc is badly scratched, deformed, or dirty. Replace or clean the disc.
- Use the correct disc format or file format.

DivX video files cannot be played.

- Ensure that the DivX video file is complete.
- Ensure that the file name extension is correct.
- Due to Digital Rights issue, the DRM-protected video files cannot be played through an analog video connection (e.g. composite, component and scart). Transfer the video content onto the Disc Media and play these files.

The aspect ratio of the screen is not aligned with the TV display setting.

- The aspect ratio is fixed on the disc.

DivX subtitles are not displayed correctly.

- Ensure that the subtitle file name is the same as the movie file name.
- Select the correct character set.
 - Press **SETUP**.
 - Select **[Preferences] > [DivX Subtitle]** in the menu.
 - Select the character set that supports the subtitle.

10 Glossary

A

Aspect ratio

Aspect ratio refers to the length to height ratio of TV screens. The ratio of a standard TV is 4:3, while the ratio of a high-definition or wide TV is 16:9. The letter box allows you to enjoy a picture with a wider perspective on a standard 4:3 screen.

D

DivX Video-On-Demand

This DivX Certified[®] device must be registered in order to play DivX Video-on-Demand (VOD) content. To generate the registration code, locate the DivX VOD section in your device setup menu. Go to vod.divx.com with this code to complete the registration process and learn more about DivX video.

J

JPEG

A very common digital still picture format. A still-picture data compression system proposed by the Joint Photographic Expert Group, which features small decrease in image quality in spite of its high compression ratio. Files are recognized by their file extension '.jpg' or '.jpeg.'

M

MP3

A file format with a sound data compression system. MP3 is the abbreviation of Motion Picture Experts Group 1 (or MPEG-1) Audio Layer 3. With the MP3 format, one CD-R or CD-RW can contain about 10 times more data than a regular CD.

P

PBC

Playback Control. A system where you navigate through a Video CD/Super VCD with on-screen menus that are recorded onto the disc. You can enjoy interactive playback and search.

Progressive scan

The progressive scan displays twice the number of frames per second than in an ordinary TV system. It offers higher picture resolution and quality.

W

WMA

Windows Media™ Audio. Refers to an audio compression technology developed by Microsoft Corporation. WMA data can be encoded with Windows Media player version 9 or Windows Media player for Windows XP. Files are recognized by their file extension '.wma.'

WARRANTY

This APPARATUS IS covered under warranty against any defect arising out of faulty or defective material or workmanship for a period of 6 months from date of purchase.

Should a defect develop during the period of warranty, Philips Electronics India Limited undertakes to repair the apparatus free of charge through an Authorised Philips service Center. If the purchaser shifts his residence to other town, the warranty will be valid at the nearest Authorised Philips service Center.

This warranty is not valid in case:

1. The apparatus is not used according to this manual;
2. Defects are caused by improper or reckless use;
3. Any repair work are done by person other than Authorised Philips Service Center;
4. Any modification or alteration of any nature are made in the apparatus;
5. The serial number is tampered
6. This warranty form is not completed immediately after purchase.

Serial No.: _____
Bill No & Date of Purchase: _____
Purchaser's Name: _____
Location & Tel No: _____
Dealer's Name: _____
Location & Tel No: _____
Dealer's Stamp & Sign: _____

Maintenance Tips for your DVD Player:

- Always keep a Disc loaded in your DVD Player tray.
- Keep the player away from the dusty areas. Keep it covered with a dust cover.
- Clean your DVD Player Lens after every 20 discs played.
 - Use the 2 brush Philips DVD Lens Cleaner SVC2520 for best results.
- Clean the CDs / VCD / DVD / MP3 CD before inserting in your DVD Player.

"For unlimited listening pleasure use
Philips earphones / headphones". Over 20 models to choose from

Philips Electronics India Limited

For any sales or service related queries:

Visit us on web at www.philips.com/support or

Call us on Tel. No.: 1860-180-1111 (BSNL / MTNL)*

011-6600-1111 (GSM / WLL)*

*"standard call rates apply"

Language Code

Abkhazian	6566
Afar	6565
Afrikaans	6570
Amharic	6577
Arabic	6582
Armenian	7289
Assamese	6583
Avestan	6569
Aymara	6589
Azerbaijani	6590
Bahasa Melayu	7783
Bashkir	6665
Belarusian	6669
Bengali	6678
Bihari	6672
Bislama	6673
Bokmål, Norwegian	7866
Bosanski	6683
Brezhoneg	6682
Bulgarian	6671
Burmese	7789
Castellano, Español	6983
Catalán	6765
Chamorro	6772
Chechen	6769
Chewa; Chichewa; Nyanja 中文	7889 9072
Chuang; Zhuang	9065
Church Slavic; Slavonic	6785
Chuvash	6786
Corsican	6779
Česky	6783
Dansk	6865
Deutsch	6869
Dzongkha	6890
English	6978
Esperanto	6979
Estonian	6984
Euskara	6985
Ελληνικά	6976
Faroese	7079
Français	7082
Frysk	7089
Fijian	7074
Gaelic; Scottish Gaelic	7168
Galleghan	7176
Georgian	7565
Gikuyu; Kikuyu	7573
Guarani	7178
Gujarati	7185
Hausa	7265
Herero	7290
Hindi	7273
Hiri Motu	7279
Hrvatski	6779
Ido	7379
Interlingua (International)	7365
Interlingue	7365
Inuktitut	7385

Inupiaq	7375
Irish	7165
Íslenska	7383
Italiano	7384
Ivrit	7269
Japanese	7465
Javanese	7486
Kalaallisut	7576
Kannada	7578
Kashmiri	7583
Kazakh	7575
Kernewek	7587
Khmer	7577
Kinyarwanda	8287
Kirghiz	7589
Komi	7586
Korean	7579
Kuanyama; Kwanyama	7574
Kurdish	7585
Lao	7679
Latina	7665
Latvian	7686
Letzeburgesch;	7666
Limbungan; Limburger	7673
Lingala	7678
Lithuanian	7684
Luxembourgish;	7666
Macedonian	7775
Malagasy	7771
Magyar	7285
Malayalam	7776
Maltese	7784
Manx	7186
Maori	7773
Marathi	7782
Marshallese	7772
Moldavian	7779
Mongolian	7778
Nauru	7865
Navaho; Navajo	7886
Ndebele, North	7868
Ndebele, South	7882
Ndonga	7871
Nederlands	7876
Nepali	7869
Norsk	7879
Northern Sami	8369
North Ndebele	7868
Norwegian Nynorsk;	7878
Occitan; Provençal	7967
Old Bulgarian; Old Slavonic	6785
Oriya	7982
Oromo	7977
Ossetian; Ossetic	7983
Pali	8073
Panjabi	8065
Persian	7065
Polski	8076
Português	8084

Pushto	8083
Russian	8285
Quechua	8185
Raeto-Romance	8277
Romanian	8279
Rundi	8278
Samoan	8377
Sango	8371
Sanskrit	8365
Sardinian	8367
Serbian	8382
Shona	8378
Shqip	8381
Sindhi	8368
Sinhalese	8373
Slovensky	8373
Slovenian	8376
Somali	8379
Sotho; Southern	8384
South Ndebele	7882
Sundanese	8385
Suomi	7073
Swahili	8387
Swati	8383
Svenska	8386
Tagalog	8476
Tahitian	8489
Tajik	8471
Tamil	8465
Tatar	8484
Telugu	8469
Thai	8472
Tibetan	6679
Tigrinya	8473
Tonga (Tonga Islands)	8479
Tsonga	8483
Tswana	8478
Türkçe	8482
Türkmen	8475
Twi	8487
Uighur	8571
Ukrainian	8575
Urdu	8582
Uzbek	8590
Vietnamese	8673
Volapuk	8679
Walloon	8765
Welsh	6789
Wolof	8779
Xhosa	8872
Yiddish	8973
Yoruba	8979
Zulu	9085



100% recycled paper
100% papier recyclé

© 2010 Koninklijke Philips Electronics N.V.

All rights reserved.

DVP3556_94_UM_V2.0_1022



72-VP3556-940B1