

DVD-Video Player / 5-Disc Changer

Owner's Manual

DVD972C



**Important!**  
Return your  
Warranty  
Registration Card  
within 10 days.  
See why inside.



**Read this manual first!**

Congratulations on purchasing this Philips product. We've included everything you need to get started. If you have any problems, Philips Representatives can help you get the most from your new product by explaining:

- Hookups,
- First Time Setup, and
- Feature Operation.

Do not attempt to return this product to the store.

**For fast help, call us first!**  
**1-800-531-0039**

Thank you for making Philips a part of your home!

*Let's make things better.*



**PHILIPS**

# Return your Warranty Registration card today to ensure you receive all the benefits you're entitled to.

Once your PHILIPS purchase is registered, you're eligible to receive all the privileges of owning a PHILIPS product. So complete and return the Warranty Registration Card enclosed with your purchase at once. And take advantage of these important benefits.

## Warranty Verification

Registering your product within 10 days confirms your right to maximum protection under the terms and conditions of your PHILIPS warranty.

## Owner Confirmation

Your completed Warranty Registration Card serves as verification of ownership in the event of product theft or loss.

## Model Registration

Returning your Warranty Registration Card right away guarantees you'll receive all the information and special offers which you qualify for as the owner of your model.

# PHILIPS

*Congratulations on your purchase, and welcome to the "family!"*

### Dear PHILIPS product owner:

Thank you for your confidence in PHILIPS. You've selected one of the best-built, best-backed products available today. And we'll do everything in our power to keep you happy with your purchase for many years to come.

As a member of the PHILIPS "family," you're entitled to protection by one of the most comprehensive warranties and outstanding service networks in the industry.

What's more, your purchase guarantees you'll receive all the information and special offers for which you qualify, plus easy access to accessories from our convenient home shopping network.

And most importantly you can count on our uncompromising commitment to your total satisfaction.

All of this is our way of saying welcome-and thanks for investing in a PHILIPS product.

Sincerely,



Lawrence J. Blanford  
President and Chief Executive Officer

**P.S. Remember, to get the most from your PHILIPS product, you must return your Warranty Registration Card within 10 days. So please mail it to us right now!**



Know these **safety** symbols



⚡ This "bolt of lightning" indicates uninsulated material within your unit may cause an electrical shock. For the safety of everyone in your household, please do not remove product covering.

⚠ The "exclamation point" calls attention to features for which you should read the enclosed literature closely to prevent operating and maintenance problems.

**WARNING:** TO PREVENT FIRE OR SHOCK HAZARD, DO NOT EXPOSE THIS EQUIPMENT TO RAIN OR MOISTURE.

**CAUTION:** To prevent electric shock, match wide blade of plug to wide slot, fully insert.

**ATTENTION:** Pour éviter les choc électriques, introduire la lame la plus large de la fiche dans la borne correspondante de la prise et pousser jusqu'au fond.

### For Customer Use

Enter below the Serial No. which is located on the rear of the cabinet. Retain this information for future reference.

Model No. \_\_\_\_\_  
Serial No. \_\_\_\_\_



# PHILIPS

Visit our World Wide Web Site at <http://www.philips.com>

# Index

---

## LASER SAFETY

This unit employs a laser. Due to possible eye injury, only a qualified service person should remove the cover or attempt to service this device.

## USE OF CONTROLS OR ADJUSTMENTS OR PERFORMANCE OF PROCEDURES OTHER THAN THOSE SPECIFIED HEREIN MAY RESULT IN HAZARDOUS RADIATION EXPOSURE.

### LASER

Type	Semiconductor laser GaAlAs
Wave length	650 nm (DVD) 780 nm (VCD/CD)
Output Power	7 mW (DVD) 10 mW (VCD/CD)
Beam divergence	60 degree

*Manufactured under license from Dolby Laboratories. "Dolby," "Pro Logic," and the double-D symbol are trademarks of Dolby Laboratories. Confidential Unpublished Works. Copyright 1992-1997 Dolby Laboratories, Inc. All rights reserved.*

*This product incorporates copyright protection technology that is protected by method claims of certain U.S. patents and other intellectual property rights owned by Macrovision Corporation and other rights owners. Use of this copyright protection technology must be authorized by Macrovision Corporation, and is intended for home and other limited viewing uses only unless otherwise authorized by Macrovision Corporation. Reverse engineering or disassembly is prohibited.*

*"DTS" and "DTS Digital Out" are trademarks of Digital Theater Systems, Inc.*

For Customer Use:

Read carefully the information located at the back of your DVD Video Player and enter below the Serial Number. Retain this information for future reference.

Model No. DVD972C

Serial No. \_\_\_\_\_

The region code for this set is 1.



Since it is usual for DVD movies to be released at different times in different regions of the world, all players have region codes and discs can have an optional region code. If you load a disc of a different region code to your player, you will see the region code notice on the screen. The disc will not play and should be unloaded.

**NOTE:  
PICTURES SHOWN MAY BE DIFFERENT  
BETWEEN COUNTRIES.**

**NEVER MAKE OR CHANGE CONNECTIONS  
WITH THE POWER SWITCHED ON.**

**CAUTION  
VISIBLE AND INVISIBLE LASER RADIATION  
WHEN OPEN AVOID EXPOSURE TO BEAM  
(WARNING LOCATION: INSIDE ON LASER  
COVERSHIELD OR THE BACKPLATE OF SET)**



# General Information

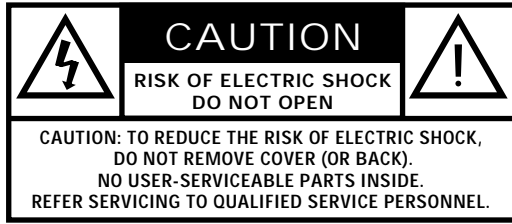

This symbol warns the user that uninsulated voltage within the unit may have sufficient magnitude to cause electric shock. Therefore, it is dangerous to make any kind of contact with any inside part of this unit.



This symbol alerts the user that important literature concerning the operation and maintenance of this unit has been included. Therefore, it should be read carefully in order to avoid any problems.



Ce symbole indique la présence d'une tension suffisamment élevée pour engendrer un risque de chocs électriques.



Ce symbole indique que le manuel d'installation fourni avec l'appareil contient d'importantes recommandations quant au fonctionnement et à l'entretien de ce dernier.



Este símbolo tiene por finalidad advertir al usuario de la presencia de tensión peligrosa no aislada dentro de la caja del aparato, que puede ser lo suficientemente fuerte para constituir un peligro de choque eléctrico.



Este símbolo sirve para advertir al usuario de la presencia de instrucciones de manejo y mantenimiento (servicio) importantes en el manual que acompaña al aparato.

## WARNING

To reduce the risk of fire or electric shock, do not expose this appliance to rain or moisture.

## CAUTION

Use of controls or adjustments or performance of procedures other than herein may result in hazardous radiation exposure.

The set complies with the FCC-Rules, Part 15 and with 21 CFR 1040.10.

## Canada

This digital apparatus does not exceed the Class B limits for radio noise emissions from digital apparatus as set out in the Radio Interference Regulations of the Canadian Department of Communications.

## AVISO

Para reducir el riesgo de fuego o choque eléctrico, no exponga el aparato a la lluvia o humedad.

## ATENCIÓN

El uso de mando o ajustes o la ejecución de métodos que no sean los aquí descritos puede ocasionar peligro de exposición a radiación.

El aparato cumple las normas FCC, Parte 15 y 21 CFR 1040.10.

## AVIS

Afin de réduire tout risque d'incendie ou de choc électrique, il ne faut pas exposer cet appareil à la pluie ou à l'humidité.

## ATTENTION

L'utilisation des commandes ou réglages ou le non-respect des procédures ci-inclues peuvent se traduire par une exposition dangereuse à l'irradiation.



L'appareil répond aux normes FCC, Part 15 et 21 CFR 1040.10.

## Canada

Cet appareil numérique n'émet pas de bruits radioélectriques dépassant les limites applicables aux appareils numériques de Class B prescrites dans le Règlement sur le Brouillage Radioélectrique édicté par le Ministère des Communications du Canada.

# IMPORTANT SAFETY INSTRUCTIONS – Read before operating equipment

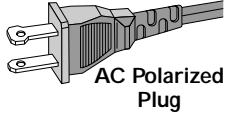
This product was designed and manufactured to meet strict quality and safety standards. There are, however, some installation and operation precautions which you should be particularly aware of.

1. **Read these instructions** – All the safety and operating instructions should be read before the appliance is operated.
2. **Keep these instructions** – The safety and operating instructions should be retained for future reference.
3. **Heed all warnings** – All warnings on the appliance and in the operating instructions should be adhered to.
4. **Follow all instructions** – All operating and use instructions should be followed.
5. **Do not use this apparatus near water** – for example, near a bathtub, washbowl, kitchen sink, or laundry tub, in a wet basement, near a swimming pool, etc
6. **Clean only with a damp cloth.** The appliance should be cleaned only as recommended by the manufacturer.
7. **Install in accordance with the manufacturer's instructions. Do not block any of the ventilation openings.** For example, the appliance should not be situated on a bed, sofa, rug, or similar surface or placed in a built-in installation, such as a bookcase or cabinet that may impede the flow of air through the ventilation openings.
8. **Do not install near any heat sources** such as radiators, heat registers, stoves, or other apparatus (including amplifiers) that produce heat.
9. **Do not defeat the safety purpose** of the polarized or grounding-type plug. A polarized plug has two blades with one wider than the other. A grounding type plug has two blades and a third grounding prong. The wide blade or the third prong are provided for your safety. When the provided plug does not fit into your outlet, consult an electrician for replacement of the obsolete outlet.
10. **Protect the power cord** from being walked on or pinched, particularly at plugs, convenience receptacles, and the point where they exit from the apparatus.
11. **Only use attachments/accessories** specified by the manufacturer.
12.  **Use only with a cart**, stand, tripod, bracket, or table specified by the manufacturer or sold with the apparatus. When a cart is used, use caution when moving the cart/apparatus combination to avoid injury from tip-over.
13. **Unplug this apparatus** during lightning storms or when unused for long periods of time.
14. **Refer all servicing** to qualified service personnel. Servicing is required when the apparatus has been damaged in any way, such as if the power-supply cord or plug is damaged, liquid has been spilled or objects have fallen into the apparatus, the apparatus has been exposed to rain or moisture, or if the unit does not operate normally or has been dropped.
15. **Battery usage CAUTION** – To prevent battery leakage that may result in bodily injury or damage to the unit:
  - Install **all** batteries correctly, + and - as marked on the unit.
  - Do not mix batteries (**old** and **new** or **carbon** and **alkaline**, etc.).
  - Remove batteries when the unit is not used for a long time.

EL 6475-E001: 00/8

# Contents

---

---

## Introduction

Philips DVD Video Introduction .....	7
Unpacking .....	7
Remote Control Battery Installation .....	7
Safety Information .....	7
Cleaning Discs .....	7

---

## Functional Overview

Front Panel and Display .....	8
Remote Control .....	9
Rear Panel .....	10

---

## Preparation

General Notes .....	11
Connecting to a TV .....	11
Connecting to Optional Equipment .....	12
General Explanation .....	13
On-Screen Display .....	13
Temporary Feedback Field Icons .....	13
Personal Preferences .....	13-16

---

## Operation

Loading Discs .....	17
Playing DVD and Video CD discs .....	17
General Features .....	17-19
Special DVD Features .....	19
Special VCD Features .....	20
Playing an Audio CD .....	20
Program .....	21
Playing MP3 Recordings .....	21-22

---

## Before Requesting Service

Before Requesting Service .....	23
---------------------------------	----

---

## Appendix

Speaker Settings .....	24
------------------------	----

---

## Specifications

Specifications .....	25
----------------------	----

---

## Limited Warranty

Limited Warranty .....	26-27
------------------------	-------

# Introduction

## Philips DVD Video Introduction

Your Philips DVD Video Player will play digital video discs conforming to the universal DVD Video standard. With it, you will be able to enjoy full-length movies with true cinema picture quality, as well as stereo or multi-channel sound (depending on the disc and your playback setup). The unique features of DVD Video, such as selection of sound track, subtitle languages and different camera angles (again, depending on the disc), are all included. In addition to DVD Video discs, you will be able to play all Video CDs and Audio CDs (including finalized CD Recordable (CD-R) and CD Rewritable (CD-RW)).

### DVD Video

You will recognize DVD Video discs by the logo shown below. Depending on the material on the disc (a movie, video clips, a drama series, etc.), the disc may have one or more Titles.

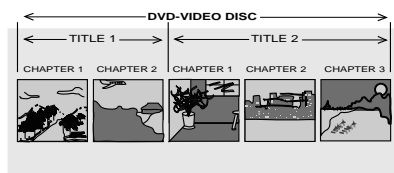

### Video CD

You will recognize Video CDs by this logo.



### Audio CD

Audio CDs contain music tracks only. You will recognize Audio CDs by this logo.



In addition, this unit can play a CD-R or CD-RW, as well as MP3 data.

#### Notes:

- Depending on the conditions of the recording equipment or the CD-R/CD-RW, some CD-R/CD-RW can not play on this unit.
- The unit can not play CD-R/CD-RW that contain no data or data other than MP3.

### High Definition Compact Disc (HDCD)



HDCD decoding provides superior reproduction of all CDs, whether HDCD-encoded or not. When HDCD-encoded discs are played, special circuitry reveals detail and fidelity not possible in ordinary CDs.

HDCD®, High Definition Digital® and Pacific Microsonics™ are either registered trademarks or trademarks of Pacific Microsonics, Inc. in the United States and/or other countries. The HDCD system is manufactured under license from Pacific Microsonics, Inc.

## Unpacking

First check and identify the contents of your DVD Player's package. You should have the following items:

- DVD Player
- Remote Control with batteries
- Audio cable
- Video cable
- S-Video cable
- Instructions for use

If any item is damaged or missing, contact your retailer or Philips.

Keep the packaging material for future transportation.

## Remote Control Battery Installation

- Insert batteries as indicated inside the battery compartment.

**Caution: Do not mix old and new batteries. Never mix different types of batteries (standard, alkaline, etc.).**

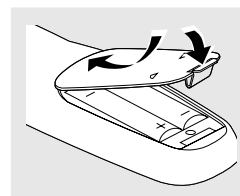

## Safety Information

- Do not expose the system to excessive moisture, rain, sand, or heat sources.
- Place the player on a firm, flat surface.
- Keep the player away from domestic heating equipment and direct sunlight.
- In a cabinet, allow about 2.5 cm (1 inch) of free space all around the player for adequate ventilation.
- If the DVD Player cannot read CDs/DVDs correctly, use a commonly available cleaning CD/DVD to clean the lens before taking the DVD Player to be repaired. Other cleaning methods may destroy the lens. Always keep the tray closed to avoid dust on the lens.
- The lens may cloud over when the DVD Player is suddenly moved from cold to warm surroundings. Playing a CD/DVD is not possible then. Leave the power on for about one hour with no disc in the unit until normal playback is possible.

## Cleaning Discs

- When a disc becomes dirty, clean it with a cleaning cloth. Wipe the disc from the center out.
- Do not use solvents such as benzine, thinner, commercially available cleaners, or anti-static spray intended for analog discs.

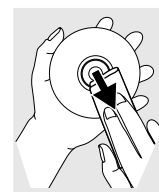

# Functional Overview

## Front Panel and Display

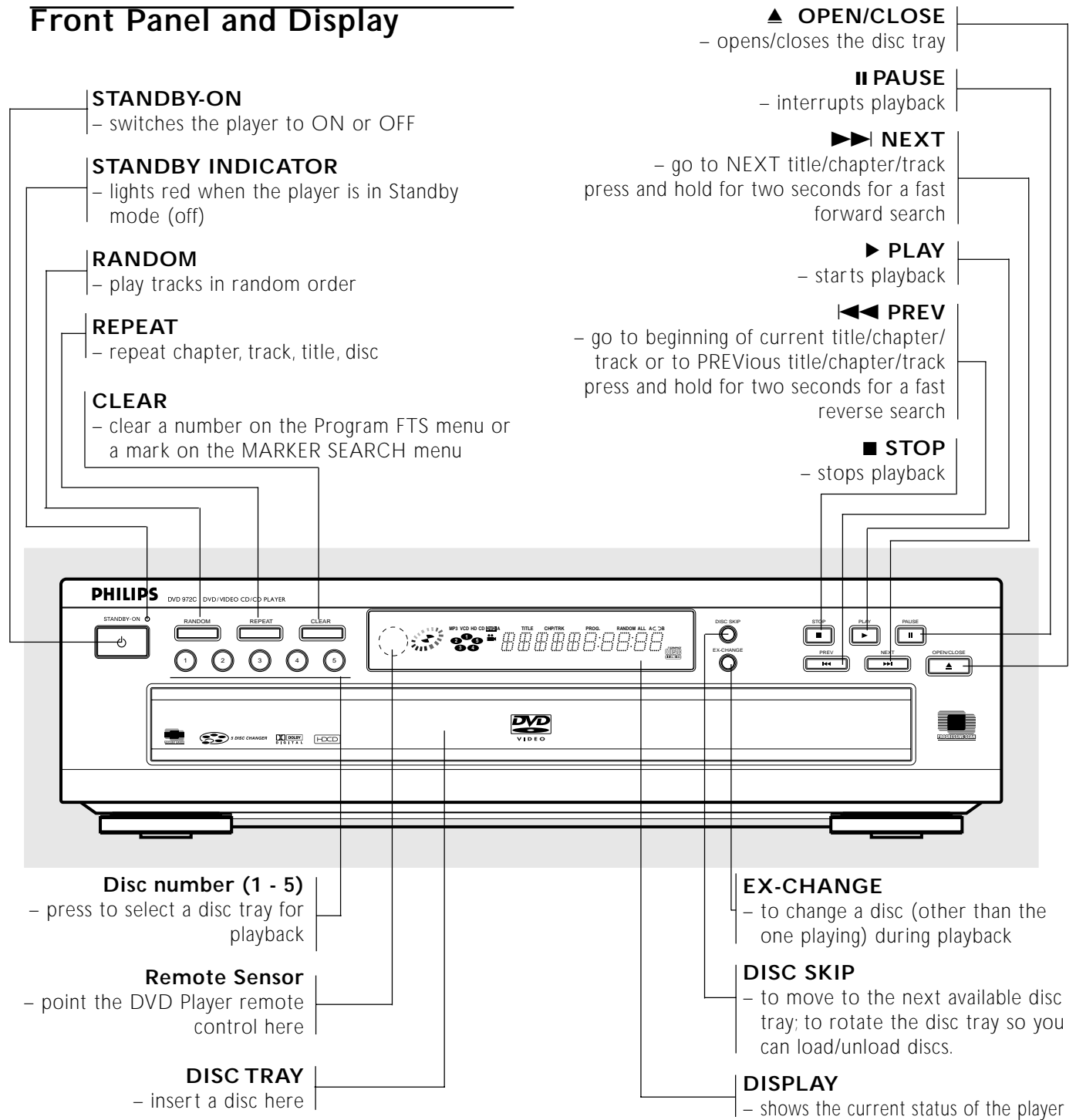

Indicates current player function: Playback, Pause etc.



A light will appear if a disc is in the disc tray. The current disc tray flashes.

**MP3**

MP3 disc inserted

**VCD**

Video CD inserted

**HD CD**

HDCD inserted

**CD**

Audio CD inserted

**DVD**

DVD inserted



ANGLE active

**TITLE** Current Title number

**CHP/TRK** Current Chapter or Track number

**PROG.** PROGRAM playback active

**RANDOM** RANDOM playback active

**AC DB** REPEAT A-B active

**ALL** REPEAT disc active



# Remote Control

## 0-9 numerical key pad

– select numbered items in a menu

## DISC MENU

– access menu of a DVD disc

## SYSTEM MENU

– access or remove DVD Player's menu



– (left/right/up/down) select an item in the menu

## OK

– acknowledge menu selection

## STOP (■)

– stops playback

## PLAY (▶)

– starts playback

## PAUSE (||)

– pause playback temporarily / press repeatedly for frame-by-frame playback

## CLEAR

– clear a track number on the Program FTS menu or a mark on the MARKER SEARCH menu

## MARKER

– access or remove MARKER SEARCH menu

## FTS (PROGRAM)

– access or remove Program FTS menu

## TITLE

– display the Title menu of the disc if available

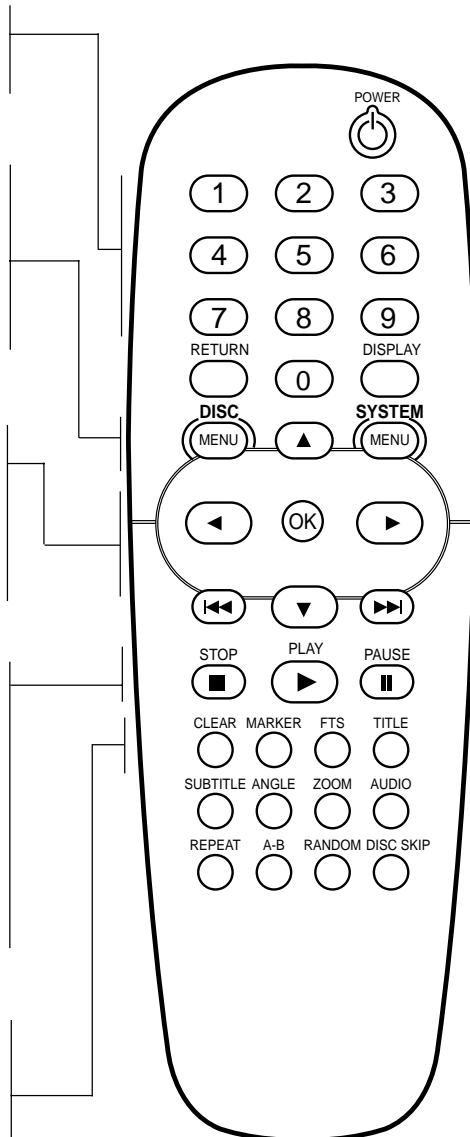

## POWER

– switch DVD Player ON or OFF

## RETURN

– remove the DVD Player's menu

## DISPLAY

– access the On-Screen Display



– search forward\* / go to next chapter or track



– search backward\* / go to beginning of current chapter or track or go to previous chapter or track

\* Press and hold key for about two seconds

## SUBTITLE

– select a subtitle language

## ANGLE

– select DVD camera angle if available

## ZOOM

– enlarge video image

## AUDIO

– select an audio language (DVD) or an audio channel (Audio CD)

## REPEAT

– repeat chapter, track, title, disc

## A-B

– repeat sequence

## RANDOM

– play tracks in random order

## DISC SKIP

– to move to the next available disc in the tray

## Rear Panel

### AC Power Cord

– connect to a power source

### VIDEO OUTPUT Switch

– select either S-Video Out or Component/Progressive Scan, depending on how you connected the DVD Player to the TV

### S-VIDEO OUT (Y/C)

– connect to a TV with S-Video (Y/C) inputs

### VIDEO OUT (CVBS)

– connect to a TV with CVBS video inputs

### OPTICAL (Digital audio out jack)

– connect to digital (optical) audio equipment

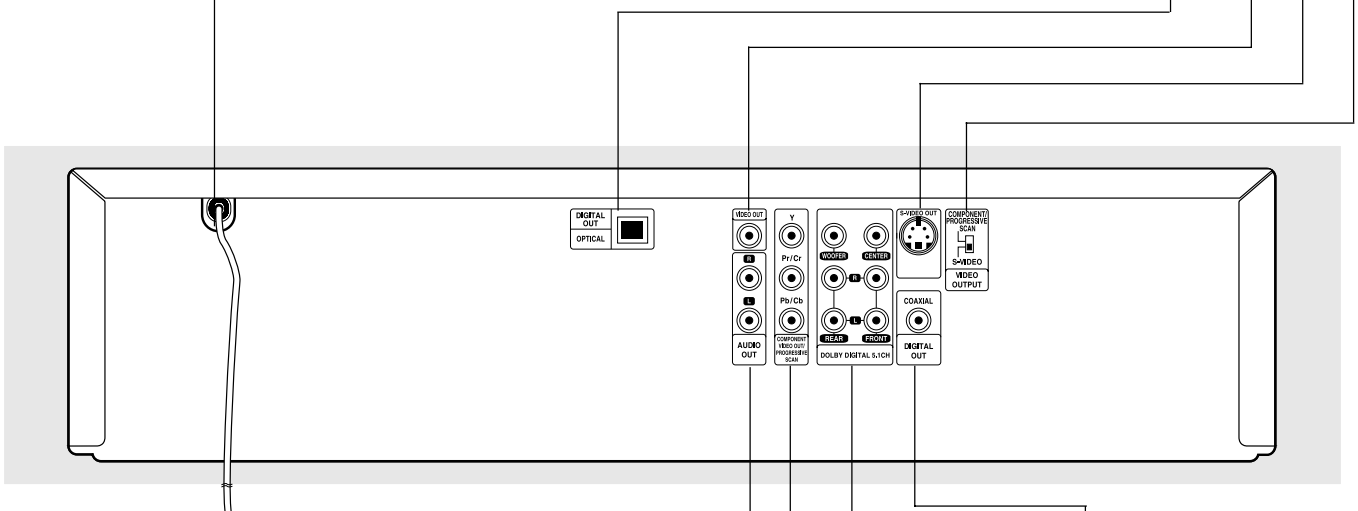

### AUDIO OUT (Left/Right)

– connect to an amplifier, receiver, TV, or stereo system

### COMPONENT VIDEO OUT/PROGRESSIVE SCAN Y Pr/Cr Pb/Cb

– connect to a TV with Y Pb/Cb Pr/Cr inputs

### DOLBY DIGITAL 5.1 CHANNEL (AUDIO OUT)

Connect to a 5.1 channel receiver

- center speaker connection
- subwoofer connection
- front speaker connections
- rear (surround) speaker connections

### COAXIAL (Digital audio out jack)

– connect to digital (coaxial) audio equipment

**Caution: Do not touch the inner pins of the jacks on the rear panel. Electrostatic discharge may cause permanent damage to the unit.**

# Preparation

## General Notes

- Depending on your TV and other equipment you wish to connect, there are various ways you could connect the player. Use only one of the connections described below.
- Please refer to the manuals of your TV, VCR, Stereo System or other devices as necessary to make the best connections.
- For better sound reproduction, connect the player's audio out jacks to the audio in jacks of your amplifier, receiver, stereo or audio/video equipment. See 'Connecting to optional equipment.'

### Caution:

- **Make sure the DVD Player is connected directly to the TV. Set the TV to the correct video input channel.**
- **Do not connect the DVD Player's audio out jacks to the phono in jack of your audio system.**
- **Do not connect your DVD Player via your VCR. The DVD image could be distorted by the copy protection system.**

## Connecting to a TV

- Make one of the following connections, depending on the capabilities of your existing equipment.
- When using the COMPONENT VIDEO OUT jacks, set the VIDEO OUTPUT switch to COMPONENT. When using the S-VIDEO OUT jack, set the VIDEO OUTPUT switch to S-VIDEO.

### Component Video (Y PR/CR PB/CB) connection

- 1 Connect the PB/CB PR/CR Y COMPONENT VIDEO OUT jacks on the DVD Player to the corresponding in jacks on the TV using an optional PR/CR PB/CB Y cable (**Z**).
- 2 Connect the Left and Right AUDIO OUT jacks of the DVD Player to the audio left/right in jacks on the TV (**A**) using the supplied audio cables.

### Progressive Scan (Y PR/CR PB/CB) connection

- If your television is a high-definition or "digital ready" television, you may take advantage of the DVD Player's progressive scan output for the highest video resolution possible.
- If your TV does not accept the Progressive Scan format, the picture will appear scrambled if you try Progressive Scan on the DVD Player.
- Make sure the TV's Sync Mode setting is correct. For example, on some Philips TVs, set "SYNC MODE" to "SYNC MODE 2." An incorrect Sync Mode setting will cause the picture to shift off-center on the TV screen while using Progressive Scan. Check your TV owner's manual for details on correct Sync Mode settings.

- 1 Connect the PR/CR PB/CB Y COMPONENT VIDEO OUT jacks on the DVD Player to the corresponding in jacks on the TV using an optional PR/CR PB/CB Y cable (**Z**).
- 2 Connect the Left and Right AUDIO OUT jacks of the DVD Player to the audio left/right in jacks on the TV (**A**) using the supplied audio cables.

### Notes:

- *The progressive scan circuitry must be activated by changing the Personal Preference. See page 14.*
- *Progressive scan does not work with the analog video connections (yellow VIDEO OUT jack).*

### S-Video (Y/C) connection

- 1 Connect the S-VIDEO OUT jack on the DVD Player to the S-Video in jack on the TV using the supplied S-Video cable (**Y**).
- 2 Connect the Left and Right AUDIO OUT jacks of the DVD Player to the audio left/right in jacks on the TV (**A**) using the supplied audio cables.

### Video (CVBS) connection

- 1 Connect the VIDEO OUT jack on the DVD Player to the video in jack on the TV using the video cable supplied (**X**).
- 2 Connect the Left and Right AUDIO OUT jacks of the DVD Player to the audio left/right in jacks on the TV (**A**) using the supplied audio cables.

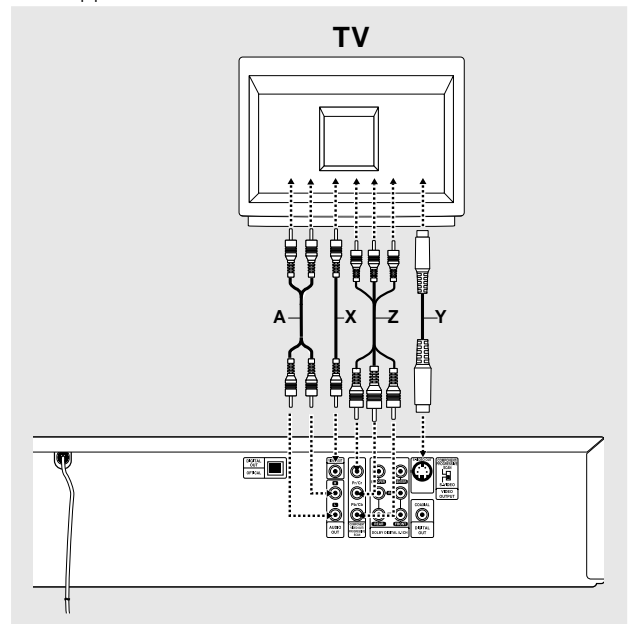

## Connecting to Optional Equipment

### Connecting to an amplifier equipped with two channel analog stereo or Dolby Surround

- 1 Connect the Left and Right AUDIO OUT jacks of the DVD Player to the audio left and right in jacks on your amplifier, receiver or stereo system, using the supplied audio cables (**A**).

### Connecting to an amplifier equipped with two channel digital stereo (PCM) or to an Audio/Video receiver equipped with a multi-channel decoder (Dolby Digital™, MPEG 2 or DTS)

- 1 Connect one of the DVD Player's DIGITAL AUDIO OUT jacks (OPTICAL **G** or COAXIAL **F**) to the corresponding in jack on your amplifier. Use an optional digital (optical **G** or coaxial **F**) audio cable.
- 2 You will need to activate the player's digital output (see 'Personal Preferences' on page 14).

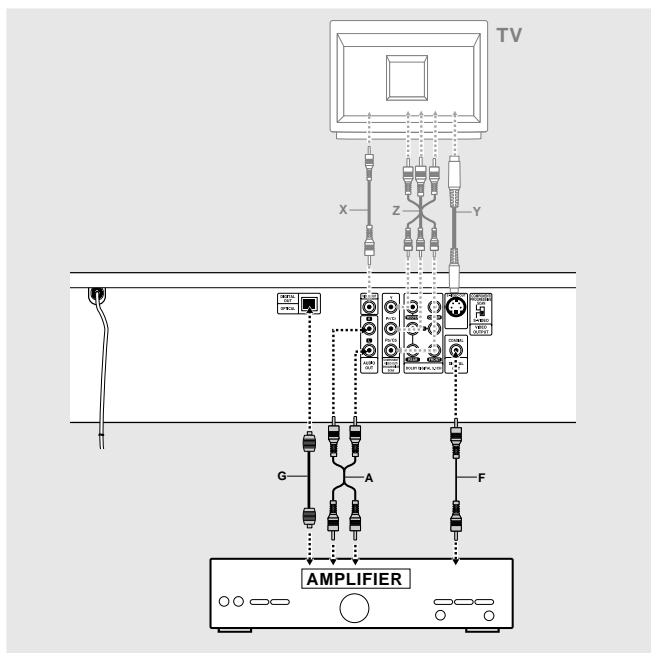

#### Digital Multi-channel sound

A digital multi-channel connection provides the best sound quality. For this you need a multi-channel Audio/Video receiver that supports one or more of the audio formats supported by your DVD Player (MPEG 2, Dolby Digital™ and DTS). Check the receiver manual and the logos on the front of the receiver.

#### Warning:

Due to the DTS Licensing agreement, the digital output will be in DTS digital out when DTS audio stream is selected.

#### Notes:

- If the audio format of the digital output does not match the capabilities of your receiver, the receiver will produce a strong, distorted sound or no sound at all.
- Six Channel Digital Surround Sound via digital connection can only be obtained if your receiver is equipped with a Digital Multi-channel decoder.
- To see the audio format of the current DVD in the On-Screen Display, press the AUDIO button.

### Analog connection to a multi-channel A/V receiver with 6 Channel connectors (Dolby Digital)

This DVD Player contains a multi-channel decoder. This enables playback of DVDs recorded in Multi-channel Surround without the need for an optional decoder.

- 1 Connect the CENTER and WOOFER jacks for the Center speaker and the Subwoofer (**C**) to the corresponding in jacks on your receiver.
- 2 Connect the Left and Right FRONT speaker jacks (**B**) to the corresponding in jacks on your receiver.
- 3 Connect the Left and Right REAR speaker jacks (**D**) to the corresponding in jacks on your receiver.
- 4 Make the appropriate Sound settings for Analog Output and Speaker Settings in the Personal Preferences menu. See page 14.

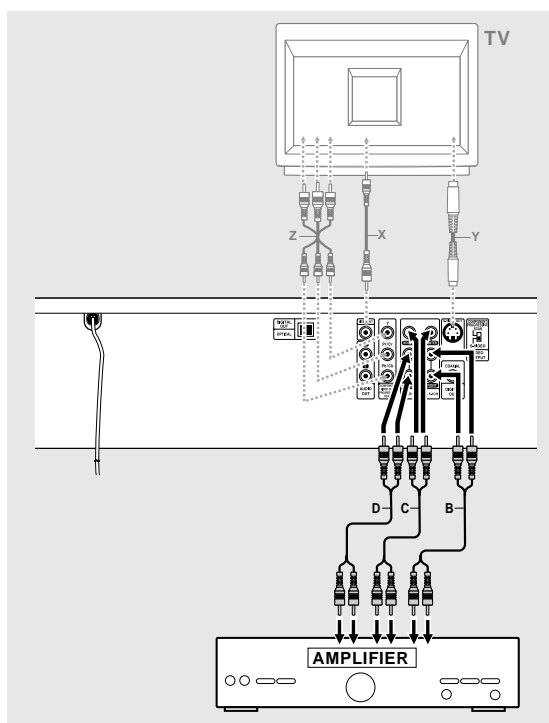





## General Explanation

This manual gives the basic instructions for operating the DVD Player. Some DVDs require specific operation or allow only limited operation during playback. When this occurs, the symbol  appears on the TV screen, indicating that the operation is not permitted by the DVD Player or is not available on the disc.

### Remote control operation

- Unless stated, all operations can be carried out with the remote control. Always point the remote control directly at the player, making sure there are no obstructions between the remote and the player. Corresponding keys on the front panel of the player can also be used.







### On-screen display operation

- A number of operations can be carried out via the on-screen display on the screen. Access the on-screen display by pressing the DISPLAY button on the remote control.
- Pressing DISPLAY again will clear the on-screen display from the screen.
- Press  or  to select an item; the selected item will be highlighted.
- Press  or  to change the setting of an item. For some functions, the setting will be registered immediately; for others, OK must be pressed.





## On-Screen Display

The following information will appear for about 10 seconds when you press the DISPLAY button on the remote control.





### DVD

	1	Current Title
	1	Current Chapter
	0:16:57	Time search
	1 ENG DID 6 CH	Audio language and Digital Audio Output mode
	OFF	Subtitle language
	1	Angle
	NORM.	Sound









### Audio CD/Video CD without PBC (Playback Control)

	1	Current Track
	0:16:57	Elapsed playback time
	STER.	Audio channel
	NORM.	Sound

### Video CD with PBC

	PBC	PBC ON
	0:16:57	Elapsed playback time
	STER.	Audio channel
	NORM.	Sound





## Temporary Feedback Field Icons

	TITLE	Repeat Title
	CHAPT	Repeat Chapter
	TRACK	Repeat Track
	DISC	Repeat Current Disc (Audio CDs and non-PBC Video CDs only)
	ALL	Repeat All Discs in the Player (Audio CDs and non-PBC Video CDs only)
	A B	Repeat A-B
	OFF	Repeat Off
		Resume play from this point
		Action prohibited or not available

## Personal Preferences

You can set your own personal preferences on the player.

### General operation

- 1 Press SYSTEM MENU on the remote control.
  - The Personal Preferences menu appears.
- 2 Press / to select the desired item.
  - The screen will show the current setting for the selected item, as well as alternate setting(s).
- 3 While the desired item is selected, press , then / to select the desired setting.
- 4 Press OK to confirm your selection. The following items can be adapted.
- 5 Press SYSTEM MENU to remove the menu when you are finished.

### Picture

#### - TV Aspect

If you have a widescreen (16:9) TV, select 16:9 Wide. If you have a regular (4:3) TV, select 4:3 Letterbox for a 'wide-screen' picture with black bars at the top and bottom of the screen, or select 4:3 Panscan for a full-height picture with the sides trimmed. If a disc supports the format, the picture will be shown accordingly.



– **Progressive Scan (Y Pr/Cr Pb/Cb connection only)**

Progressive Scan Video provides the highest quality pictures with less flickering.

If you are using the Component Video jacks, but are connecting the DVD Player to a standard (analog) television, set Progressive Scan to Off.

If you are using the Component Video jacks for connection to a TV or monitor that is compatible with a progressive scan signal, set Progressive Scan to On.

**Notes:**

- Progressive Scan only works when the VIDEO OUTPUT switch on the rear panel is set to COMPONENT/PROGRESSIVE SCAN.
- Make sure the TV's Sync Mode setting is correct. For example, on some Philips TVs, set "SYNC MODE" to "SYNC MODE 2." An incorrect Sync Mode setting will cause the picture to shift off-center on the TV screen while using Progressive Scan. Check your TV owner's manual for details on correct Sync Mode settings.

**Caution:**

- Once the setting for progressive scan output is entered, an image will only be visible on a progressive scan compatible TV or monitor. If you set Progressive Scan to On in error, you must reset the unit. Press STOP to stop any disc that is playing. Next, press STOP again and hold it for five seconds before releasing it. The video output will be restored to the standard setting, and a picture will once again be visible on a conventional analog TV or monitor.

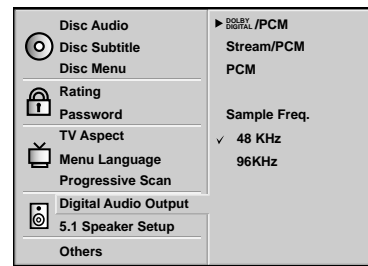

– **Sample Frequency**

To change the Sample Frequency setting, first select the desired Digital Audio Output as indicated at left. If your receiver or amplifier is NOT capable of handling 96KHz signals, select 48KHz. When this choice is made, this unit will automatically convert any 96KHz signals to 48KHz so your system can decode them. If your receiver or amplifier is capable of handling 96KHz signals, select 96KHz. When this choice is made, this unit will pass each type of signal through without any further processing.

– **5.1 Speaker settings**

Select speaker settings, including volume balance and delay time, or test the speaker settings. Speaker settings are only active on the Analog Multi-Channel Output. (See appendix, page 24.)



**Sound**

– **Digital Audio Output**

Each DVD disc has a variety of audio output options. Set the player's Digital Audio Output according to the type of audio system you use.

**DOLBY DIGITAL/PCM:** Select "DOLBY DIGITAL/ PCM" if you connected the DVD Player's DIGITAL OUT jack to a Dolby Digital decoder (or an amplifier or other equipment with a Dolby Digital decoder).

**Stream/PCM:** Select "Stream/PCM" if you connected the DVD Player's DIGITAL OUT jack to an amplifier or other equipment with a DTS decoder, Dolby Digital decoder or MPEG decoder.

**PCM:** Select "PCM" if you connected the DVD Player's DIGITAL OUT jack to an amplifier or other equipment with linear PCM only (or Mini Disc (MD) recorder or Digital Audio Tape (DAT) deck).

## Language

### - Language (Disc Audio, Disc Subtitle and Disc Menu)

Select a language for the disc's Menu, Audio and Subtitle. Audio language and Subtitle language also can be adapted using the On-Screen Display. Press the ▲/▼ buttons to select an item, then press the ◀▶ buttons to choose a setting in the On-Screen Display (menu bar).



### - Menu Language

Select the language for the DVD Player's Menu. This is the menu you see when you press the SYSTEM MENU button.



## Others

### - Dynamic Range Control (DRC)

With the DVD format, you can hear a program's soundtrack in the most accurate and realistic presentation possible, thanks to digital audio technology. However, you may wish to compress the dynamic range of the audio output (the difference between the loudest sounds and the quietest ones). Then, you may listen to a movie at a lower volume without losing dialog intelligibility. Set DRC to On for this effect.

### - PBC

Set Playback Control (PBC) to On or Off.

- On: Video CDs with PBC are played according to the PBC.
- Off: Video CDs with PBC are played the same way as Audio CDs.

### - Vocal

Set Vocal to On only when a multi-channel karaoke DVD is playing. The karaoke channels on the disc will mix into a normal stereo sound.



## Parental control (DVD only)

Movies on DVDs may contain scenes not suitable for children. Therefore, discs may contain 'Parental Control' information that applies to the complete disc or to certain scenes on the disc. These scenes are rated from 1 to 8, and alternative, more suitable scenes are available on some discs. Ratings are country dependent. The 'Parental Control' feature allows you to prevent discs from being played by your children or to have certain discs played with alternative scenes.

### - Rating

- 1 Press SYSTEM MENU to display the DVD Player's Menu.
- 2 Select Rating using the ▲/▼ keys.
- 3 While Rating is selected, press ▶.
- 4 Enter your 4-digit password now. Use the numerical keys to enter your code, then press OK. This is only necessary if you have set the Password. Details are on page 16.
- 5 Select a rating from 1 to 8 using the ▲/▼ keys. One (1) allows the least playback. Eight (8) allows the most playback.

#### Unlock:

If you select Unlock, Parental Control is not active. The Disc will play in full.

#### Ratings 1 to 8:

Some discs contain scenes not suitable for children. If you set a rating for the player, all disc scenes with the same rating or lower will be played. Higher rated scenes will not be played unless an alternative scene is available on the disc. The alternative must have the same rating or a lower one. If no suitable alternative is found, playback will stop. You must enter the 4-digit code or change the rating level in order to play the disc.

- 6 Press OK to confirm your rating selection, then press SYSTEM MENU to exit the menu.

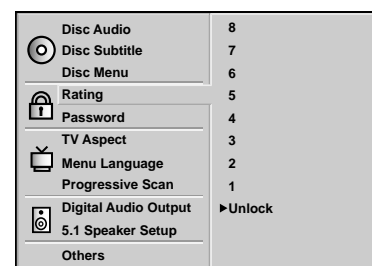

### - Password

- 1 To set the Password for the first time, press SYSTEM MENU to display the DVD Player's Menu.
- 2 Select Password using the ▲/▼ keys.
- 3 While Password is selected, press ►.
- 4 Enter the 4-digit password using the numeric keys (0-9), then press OK.
- 5 Enter the 4-digit password again to verify it, then press OK.
- 6 Press SYSTEM MENU to remove the menu.

*Note: Confirmation of the 4-digit code is necessary when the code is changed (see 'Changing the 4-digit code').*

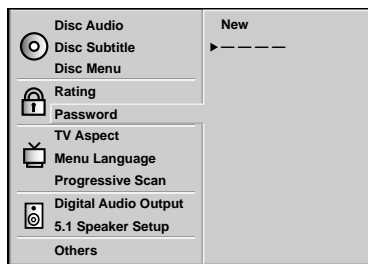

### - Changing the 4-digit code

- 1 Press SYSTEM MENU to display the DVD Player's Menu.
- 2 Select Password using the ▲/▼ keys.
- 3 While Password is selected, press ►.
- 4 Enter the old code, then press OK.
- 5 Select Change using the ▲/▼ keys.
- 6 Press OK.
- 7 Enter the new 4-digit code, then press OK.
- 8 Enter exactly the same code a second time and verify by pressing OK.
- 9 Press SYSTEM MENU to exit the menu.

### - If you forget your 4-digit code

If you forget your password, to clear the current password, follow the procedure below.

- 1 Press SYSTEM MENU to display the DVD Player's Menu.
- 2 Use the Number buttons to enter the 6-digit number "210499."  
→ The 4-digit password is cleared. "P CLR" appears on the display. The message will appear if the disc tray is closed. It will be on the display until you try another feature.
- 3 Enter a new code as described above (Password).

### - If a Disc will not play

If you insert a disc that exceeds the rating level you set, you may see the message "Parental Control Limit." If so, press PLAY button and the password input screen will appear, next press the numerical keys to enter your four-digit password, then press the OK button. The disc will be available for playback as usual.

Or, you may see this message if you insert a disc that exceeds the rating level: "The parental setting of this player prohibits play. Would you like to allow this disc to play?" Press the ◀▶ buttons to select "Yes" or "No," then press the OK button. If you select "No," a message will remind you that the disc will not play. Press the OPEN/CLOSE button to remove the disc.

Or, if you select "Yes," next press the numerical keys to enter your four-digit password, then press the OK button. The disc will be available for playback as usual.

#### Notes:

- The messages will vary among discs.
- After you clear a message as described above, the disc will play as usual. However, if you turn off the DVD Player or open the disc tray, you will repeat these steps again if you try to play the same disc later.

### - Parental Control Disclaimer

This DVD Player features the PARENTAL CONTROL system, which is intended to be active when playing DVD discs with certain software coding. This is according to technical standards adopted by the set maker and disc content industries.

Please note that PARENTAL CONTROL will not control a DVD that does not have the appropriate software coding. At the time of release of this DVD Player, certain aspects of the technical standards had not been settled between set makers and the disc content industries.

For these reasons, Philips cannot guarantee the functioning of PARENTAL CONTROL and denies any liability associated with unintended watching of discs.

If in doubt, please make sure the disc plays according to your PARENTAL CONTROL settings before you allow children access to the DVD Player.



# Operation

## Loading Discs

- 1 Press OPEN/CLOSE on the front of the player to open the disc tray.
- 2 Load your chosen disc in the tray, with the label facing up. When a double-sided DVD is inserted, make sure the side you want to play is facing up.  
→ Discs can be loaded one at a time by pressing DISC SKIP to rotate the carousel.
- 3 Press OPEN/CLOSE again to close the tray.  
→ READING appears on the TV screen, and playback starts automatically. In some cases, the disc menu might appear instead. The disc that was in the front tray will be selected for play.

### Note:

– If 'Parental Control' is set and the disc is not within the 'Rating' settings (not authorized), the 4-digit code must be entered and/or the disc must be authorized (see 'Parental Control' on pages 15-16).

## Exchanging discs during playback

- Press EX-CHANGE on the front panel during playback to open the disc tray.
- Press DISC SKIP to rotate the disc trays to the desired position. The carousel will move clockwise by one disc tray.
- Exchange the discs and press EX-CHANGE or OPEN/CLOSE to close the disc tray.

### Note:

– The disc tray which was in the play position can not be exchanged.

## Skipping discs

- Press DISC SKIP during play or when playback is stopped. Each time the button is pressed, the next disc tray is selected.

### Note:

– When DISC SKIP is pressed, the disc trays rotate and play begins from the beginning of the next disc.  
– If there is no disc on the next disc tray, the next disc tray will be selected.  
– When DISC SKIP is pressed during playback of disc 5, playback of disc 1 will start.

## Exchanging the disc and starting playback

- Press OPEN/CLOSE during playback or when playback is stopped. Play stops (if pressed during playback), the disc tray opens and the disc tray that was in the play position comes to the front.
- Exchange the disc in the front.
- Press OPEN/CLOSE or PLAY again. The tray closes and playback begins (with the disc that was in front).

## Playing DVD and Video CD discs

- After inserting the disc and closing the tray, playback starts automatically, depending on the disc. The player's display shows the type of disc loaded, as well as the disc's information and playing time.
- The disc may invite you to select an item from a menu. If the selections are numbered, press the appropriate numerical key; if not, use the ▲/▼, ◀▶ keys to highlight your selection, then press OK.
- The number of the current title and chapter show on the display.
- Playback may stop at the end of the Title, and you may return to the disc menu. To go to the next title, press PLAY.
- To stop playback, press STOP.  
→ The default screen will appear.  
→ The screen saver picture appears when you leave the DVD Player in stop mode for about five minutes.  
→ After the Screen Saver has been engaged for about five minutes, the DVD Player will automatically turn itself off.
- You can resume playback from the point at which you stopped playback. If you see the Resume icon ■■ on the screen when you stop playback, press PLAY to resume playback from that point.



### Notes:

– DVDs may have a region code.  
– Your player will not play discs that have a region code different from your player. The region code for this player is 1 (one).  
– Do not touch the loading drawer and carousel while they are in motion, and do not attempt to rotate the carousel by hand; doing so could result in incorrect operation of the player and/or damage to the discs.

## General Features

### Note:

– Unless stated, all operations described are based on remote control use. Some operations can be carried out using the DVD Player's menu.

## Moving to another TITLE

When a disc has more than one title, you can move to another title as follows:

- Press DISPLAY when playback is stopped, then press the appropriate numerical key (0-9) to select a title number.

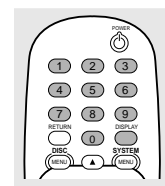

## Moving to another CHAPTER/TRACK

When a title on a disc has more than one chapter or a disc has more than one track, you can move to another chapter/track as follows:

- Press ▶▶ or ◀◀ briefly during playback to select the next chapter/track or to return to the beginning of the current chapter/track.
- Press ◀◀ twice briefly to step back to the previous chapter/track.
- To go directly to any chapter during DVD playback, press DISPLAY. Then, press ▲/▼ to select C (chapter) (or for a Video CD, select T for track). Then, enter the chapter/track number using the numerical keys (0-9).

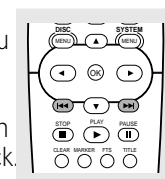

### Note:

– For two-digit numbers, press the keys in rapid succession.

## Slow Motion

- Press PAUSE during playback.  
→ The player will enter PAUSE mode.
- Use the ◀▶ keys to enter the SLOW mode.
- Use the ◀▶ keys to select the required speed: ◀ 1/16, ◀ 1/8, ◀ 1/4 or ◀ 1/2 (backward), or ▶ 1/16, ▶ 1/8, ▶ 1/4 or ▶ 1/2 (forward).
- If PAUSE is pressed again, the speed will be set to zero (PAUSE) and playback will pause.
- To exit slow motion mode, press PLAY.

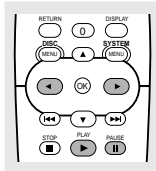

### Note:

– Slow motion playback in reverse is not applicable for Video CD.

## Still Picture and Frame-by-frame playback

- Press PAUSE during playback.  
→ The player will now go into PAUSE mode.
- You can advance the picture frame by frame by pressing PAUSE or ▲ repeatedly on the remote control.
- You can reverse the picture frame by frame by pressing ▼ repeatedly on the remote control.

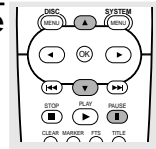

### Note:

– You can not reverse the picture frame by frame for Video CD.

## Search

- Press and hold ▶▶▶ or ◀◀◀ for about two seconds during playback.  
→ The player will now go into SEARCH mode.
- Press and hold ▶▶▶ or ◀◀◀ repeatedly to select the required speed: ◀◀X2, ◀◀X4, ◀◀X16, ◀◀X100 (backward) or ▶▶X2, ▶▶X4, ▶▶X16, ▶▶X100 (forward).
- To exit SEARCH mode, press PLAY.
- With a Video CD, the Search speed changes: ◀◀X2, ◀◀X4, ◀◀X8 (backward) or ▶▶X2, ▶▶X4, ▶▶X8 (forward).

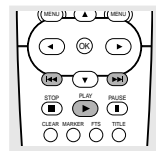

## Repeat



### DVD Video Discs - Repeat Chapter/ Title/Off

- To repeat the currently playing chapter, press REPEAT.  
→ The **Repeat Chapter** icon appears on the TV screen.
- To repeat the title currently playing, press REPEAT a second time.  
→ The **Repeat Title** icon appears on the TV screen.
- To exit Repeat mode, press REPEAT a third time.  
→ The **Repeat Off** icon appears on the TV screen.

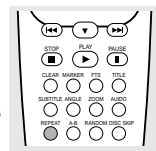

### Video CDs - Repeat Track/Disc/All/Off

- To repeat the track currently playing, press REPEAT.  
→ The **Repeat Track** icon appears on the TV screen.
- To repeat the disc currently playing, press REPEAT a second time.  
→ The **Repeat Disc** icon appears on the TV screen.
- To repeat all discs (CD & Video CD without PBC) in the unit, press REPEAT a third time.  
→ The **Repeat All** icon appears on the TV screen.
- To exit Repeat mode, press REPEAT a fourth time.  
→ The **Repeat Off** icon appears on the TV screen.

### Note:

– On a Video CD with PBC, you must set PBC to Off under Personal Preference to use the Repeat function. See page 15.

## Repeat A-B

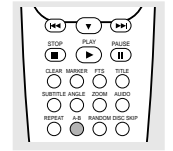

To repeat a sequence in a title:

- Press A-B at your chosen starting point.  
→ A- appears briefly on the TV screen.
- Press A-B again at your chosen end point.  
→ A-B appears briefly on the TV screen, and the repeat sequence begins (a-b repeat appears on the player's display).
- To cancel the sequence, press A-B.

## Time search

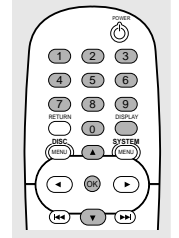

The Time Search function allows you to start playing at any chosen time on the disc.

- Press DISPLAY during playback. The on-screen display appears on the screen.  
→ The Time Search box shows the elapsed playing time of the current disc.
- Within 10 seconds, press ▲/▼ to select the Time Search icon in the on-screen display.  
→ The “-:-:-” appears in the Time Search box.
- Within 10 seconds, use the numerical keys to enter the required start time. Enter hours, minutes and seconds from left to right in the box.  
→ If you enter the wrong numbers, press CLEAR to remove the numbers you entered. Then enter the correct numbers.
- Within 10 seconds, press OK to confirm the start time.  
→ Playback starts from the selected time on the disc. If you enter an invalid time, playback will continue from the current point.

### Note:

– Time Search is not supported for Video CD.

## Zoom

The Zoom function allows you to enlarge the video image and to move through the enlarged image.

- Press ZOOM during playback or still playback to activate the Zoom function.  
→ If you press ZOOM repeatedly, the magnification level increases up to six times.
- Use the ◀ ▶ ▲ ▼ keys to move through the zoomed picture.
- Press CLEAR to resume normal playback or return to the paused image.

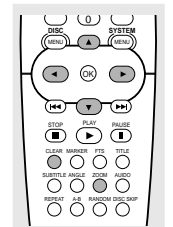

## Marker search

You can start playback from a memorized point. Up to nine points can be memorized.

To enter a mark, follow these steps.

- 1 During disc playback, press MARKER.  
→ The MARKER SEARCH menu will appear on the TV screen briefly.
- 2 During playback, press OK when playback reaches the spot that you want to memorize. (Do this within 10 seconds while the MARKER SEARCH menu appears.)  
→ The Marker number appears.
- 3 To enter additional Marker points, press ◀▶ until another empty point on the MARKER SEARCH menu is highlighted, then press OK when playback reaches the point at which you want the next Marker.
- 4 Repeat steps 2 and 3 to enter up to nine Marker points on a disc.
- 5 To remove the MARKER SEARCH menu, press MARKER.

The marked spots will remain in the player's memory as long as the disc is not changed. The Marker memory will remain active if the disc is stopped. It will be lost if the disc is removed from the player, if the disc tray is opened, or if the DVD Player is turned off.



### - To Recall a Marked Scene

- 1 During disc playback, press MARKER.  
→ The MARKER SEARCH menu will appear on the screen.
- 2 Within 10 seconds, press ◀▶ to select a Marker number that you want to recall.
- 3 Press OK.  
→ Playback will start from the Marked scene.
- 4 To remove the MARKER SEARCH menu, press MARKER.

### - To clear a Marked Scene

- 1 During disc playback, press MARKER.  
→ The MARKER SEARCH menu will appear on the screen.
- 2 Press ◀▶ to select the Marker number that you want to erase.
- 3 Press CLEAR.  
→ The Marker number will be erased from the list.
- 4 Repeat steps 2 and 3 to erase additional Marker numbers.
- 5 To remove the MARKER SEARCH menu, press MARKER.

## Memorizing Settings for Viewed disc (Condition Memory)

This player memorizes the last scene for the last disc you have watched. Settings remain in memory even if you remove the disc from the player or switch off the player. If you load a disc that has its settings memorized, the latest stop position is automatically recalled.

### Notes:

- Settings are stored in memory for use any time.
- Switching of the audio mode, etc., is automatic on some discs.
- This player does not memorize settings if you switch off the player when a DVD or title menu appears on the TV screen.

## Special DVD Features

### Checking the contents of DVD Video discs: Menus

DVDs may contain menus that allow you to access special features. To use the disc menu, press the DISC MENU button. Then, press the appropriate numerical key to select an item. Or, use the ▲▼◀▶ keys to highlight your selection, then press OK.

### Title menus

- Press TITLE.  
→ If the current title has a menu, the menu will appear on the screen. Otherwise, the disc menu may appear.
- The menu can list camera angles, spoken language and subtitle options, and chapters for the title.
- To remove the title menu, press TITLE again.

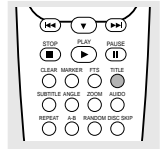

### Disc menu

- Press DISC MENU.  
→ The disc menu is displayed.
- To remove the disc menu, press DISC MENU again.

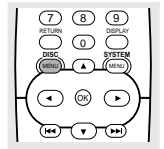

### Camera Angle

If the disc contains sequences recorded from different camera angles, the angle icon blinks on the display. You can then change the camera angle if you wish.

- Press ANGLE repeatedly during playback to select a desired angle.  
→ The number of the current angle appears on the display.

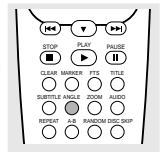

### Changing the audio language

- Press AUDIO repeatedly during playback to hear a different audio language or audio track.

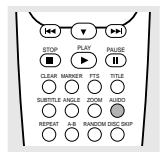

### Subtitles

- Press SUBTITLE repeatedly during playback to see the different subtitle languages.



### Note:

- If  appears, the feature is not available on the disc.

## Special VCD Features

### Playback Control (PBC)

- Load a Video CD with PBC and press PLAY.
- Go through the menu with the keys indicated on the TV screen until your chosen passage starts to play. If a PBC menu includes titles, you can select a title directly.
- Enter your choice with the numerical keys (0-9).
- Press RETURN to go back to the previous menu.
- You also may set PBC to Off under Personal Preferences. See page 15.

### Playing an Audio CD

- After inserting the Audio CD and closing the tray, the number of total tracks and the total playing time of the disc will appear on the display. Press PLAY to start playback.
- During playback, the current track number and its elapsed playing time will appear on the display.
- Playback will stop at the end of the disc.
- To stop playback at any other time, press STOP.



### Pause

- Press PAUSE during playback.
- To return to playback, press PLAY or press PAUSE again.

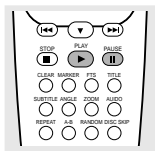

### Search

- To search forward or backward through the disc at two times the normal speed, hold down ►► or ◀◀ for about two seconds during playback.
  - Search begins, and sound is partially muted.
- To step up to four times the normal speed, hold down ►► or ◀◀ again.
  - Search goes to four times the speed, and the sound is partially muted.
- To step up to eight times the normal speed, hold down ►► or ◀◀ again.
  - Search goes to eight times the speed, and the sound is partially muted.
- To return to two times the normal speed, hold down ►► or ◀◀ again.
- If the TV is on, search speed and direction are indicated on the screen each time ►► or ◀◀ is pressed.
- To end the search, press PLAY to resume playback or STOP to stop playback. The search will stop if the beginning or end of the disc is reached. If the beginning of the disc is reached, playback may begin again.

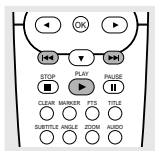

### Moving to another track

- Press ►► or ◀◀ briefly during playback to go to the next track or to return to the beginning of the current track.
- Press ◀◀ twice briefly to step back to the previous track.
- To go directly to any track, enter the track number using the numerical keys (0-9) during playback.



### Random

- Press RANDOM during playback or when playback is stopped.
  - The unit automatically begins Random Playback and RANDOM (1-3) appears on the TV or monitor.
  - RANDOM1: Plays all the tracks on a single disc in random order and then stops.
  - RANDOM2: Plays all the tracks on all discs in random order then stops.
  - RANDOM3: Plays two tracks randomly from a disc, then plays two tracks randomly from a different disc until all tracks on all discs have been played.
- To return to normal playback, press RANDOM repeatedly until NORMAL appears on the display.

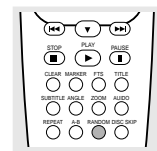

### Repeat Track/Disc/All/Off

- To repeat the track currently playing, press REPEAT.
  - The **Repeat Track** icon appears on the TV screen.
- To repeat the disc currently playing, press REPEAT a second time.
  - The **Repeat Disc** icon appears on the TV screen.
- To repeat all discs (CD & Video CD without PBC) in the unit, press REPEAT a third time.
  - The **Repeat All** icon appears on the TV screen.
- To exit Repeat mode, press REPEAT a fourth time.
  - The **Repeat Off** icon appears on the TV screen.

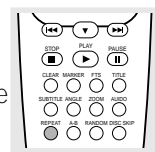

#### Note:

– On a Video CD with PBC, you must set PBC to Off under Personal Preference to use the Repeat function. See page 15.

### Repeat A-B

- To repeat a sequence:
  - During disc playback, press A-B at your chosen starting point.
    - A [ ] appears on the player display.
  - Press A-B again at your chosen end point.
    - A [ ] B appears on the display, and the sequence begins to play repeatedly.
  - To exit the sequence and return to normal play, press A-B again.

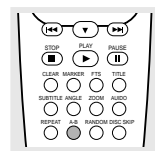

---

## Program

- Program allows you to store your favorite tracks for a particular disc in the player memory.
- A Program can contain 20 tracks.

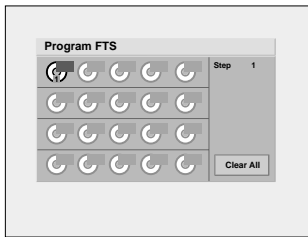

### - Storing a Program

- 1 Load a disc and stop playback.
- 2 Press FTS.  
→ The program menu appears on the screen
- 3 Enter the disc tray number using the numerical keys (0-9) and then press OK.
- 4 Enter the track number using the numerical keys (0-9) and then press OK.  
→ The next area is selected.
- 5 Repeat steps 3 - 4 to enter other tracks.
- 6 Press FTS or RETURN to exit the screen.
- 7 Press PLAY to begin playback. Pressing the FTS button repeatedly during playback will toggle between play of the Program and Normal order playback.

### - Erasing a track from a Program

- 1 Press FTS to display the program menu.
- 2 Use ◀ ▶ ▲ ▼ to select the track number you wish to erase.
- 3 Press CLEAR.  
→ The track number will be erased from the track list.

### - Erasing the complete Program

- 1 Use ◀ ▶ ▲ ▼ to select Clear All, then press OK.  
→ The complete Program for the discs will be erased.

---

## Playing MP3 Recordings

The DVD Player can play MP3 format recordings on CD-ROM, CD-R or CD-RW discs.  
Before playing MP3 recordings, read the following notes.

---

### Notes on MP3 recordings

#### - About MP3

- An MP3 file is audio data compressed by using MPEG1, the audio layer-3 file-coding scheme. We call files that have the ".mp3" file extension "MP3 files."
- The player can not read an MP3 file that has a file extension other than ".mp3."
- Noises may be heard if you play a non-MP3 file that has the

".mp3" extension.

#### - The restriction of playing MP3

- This unit can play up to 200 files per disc. A disc having more than 200 files cannot be played.
- The unit may not play MP3 files in the order that you recorded them on the disc.
- With a multi-session disc, the player plays only the last session.
- It may take over 30 seconds to read the MP3 files, depending on the contents of the disc.

#### - The limitation of indications

- Up to eight characters are displayed for the name of a track.
- Characters other than uppercase letters ("A" to "Z"), numerals ("0" to "9") and underscore ("\_") may not be displayed, or may be displayed in different characters. The elapsed playing time on the display may not be correct when playing MP3 files.

---

### Tips on recording MP3

To enjoy high quality sound, convert to MP3 files with a sampling frequency of 44.1kHz and a fixed bit rate of 128 kbps.

#### To play MP3 files in the order that you recorded them

- 1 Writing software that is capable of recording MP3 files in numerical and alphabetical order is required.
- 2 Include a two or three digit number at the beginning of each file name. (e.g. "01," "02," ... or "001," "002," ...)
- 3 It's recommended that you use only the root folder (do not create a child folder under the root folder).

---

### Glossary

#### Extension:

An extension is the last three characters that divide a file name by a period. The extension shows the attribution of the file or the software in which the file was created.

#### Session:

A session is one section on a disc between the beginning of data and the end of written data.  
A multi-session disc has more than two sessions.

## Playing MP3 Recordings

- 1 Insert a disc and close the tray.  
→ The MP3 menu appears on the TV screen.  
*Note*  
– It may take over 30 seconds to read the MP3 files, depending on the contents of the disc.
- 2 Press ▲/▼ to select the MP3 file you want to play.
- 3 Press PLAY.  
→ Playback starts; playback will end when all tracks on the disc have played.

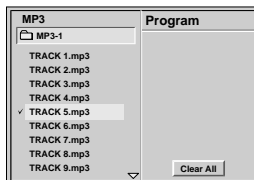

## Moving to another track

- Press ►► or ◀◀ briefly during playback to go to the next track, or press ▲/▼ to select the desired track in the menu and press PLAY.

## Pause

- Press PAUSE during playback.
- To return to playback, press PLAY or PAUSE again.

## Stop

- Press STOP during playback.

## Programmed playback with MP3

- 1 Insert the disc and close the tray.  
→ The MP3 menu is displayed on the TV screen.
- 2 Press FTS while playback is stopped to enter the Program Edit mode.  
→ The E mark will appear to the right of the word Program on the right side of the MP3 menu.

### Note

– Press RETURN or FTS to exit the Program Edit mode; the E mark will disappear.

- 3 Press ▲/▼ to select a track.
- 4 Press OK to place the selected track on the MP3 Program.  
→ Repeat steps 3 to 4 to place additional tracks in the program.
- 5 Press PLAY to start.  
→ Playback begins in the order in which you programmed the tracks.  
→ Playback stops after all of the tracks on the Program have played once.

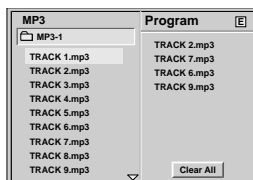

## Erasing a track from a Program

- 1 Press FTS while playback is stopped.  
→ The E mark will appear.
- 2 Press ► to move to the Program list.
- 3 Use ▲/▼ to select the track that you wish to erase from the Program list.
- 4 Press CLEAR.  
→ The track will be erased from the Program.

## Erasing the complete Program

- 1 Press FTS while playback is stopped.  
→ The E mark will appear.
- 2 Use ◀▶ to select Clear All, then press OK.  
→ The complete Program for the disc will be erased.  
→ The programs are also cleared when the disc is removed.

## MP3-Repeat track/all

### – MP3 - Repeat track/all

- To repeat the track currently playing, press REPEAT.  
→ The Repeat icon appears to the right of the track name.
- To repeat all the tracks, press REPEAT a second time.  
→ The Repeat icon appears to the right of the directory name.
- To exit Repeat mode, press REPEAT a third time.  
→ The Repeat icon disappears.

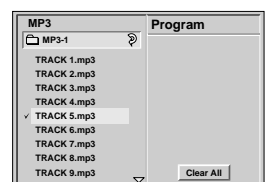
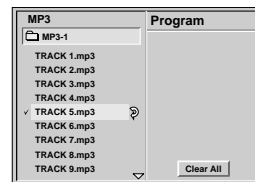

### – MP3 - Repeat Programs

- During Program playback, to repeat the current track, press REPEAT.  
→ The Repeat icon appears to the right of the track name.
- To repeat all of the programmed tracks, press REPEAT a second time.  
→ The Repeat icon appears to the right of Program.
- To exit Repeat mode, press REPEAT a third time.  
→ The Repeat icon disappears.

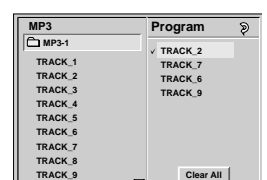
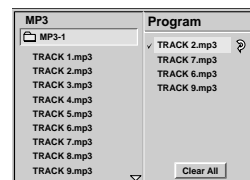

# Before Requesting Service

---

If it appears that the DVD Player is faulty, first consult this checklist. It may be that something has been overlooked. Under no circumstances should you attempt to repair the system yourself; this will invalidate the warranty.

Look for the specific symptom(s). Then perform only the actions listed to remedy the specific symptom(s).

Symptom	Remedy
<b>No power</b>	<ul style="list-style-type: none"><li>– Make sure the power cord is connected properly.</li><li>– Make sure there is power at the AC outlet by plugging in another appliance.</li></ul>
<b>No picture</b>	<ul style="list-style-type: none"><li>– Check if the TV is on.</li><li>– Check the video connection. See page 11.</li><li>– Make sure the TV is on the correct Video In or Auxiliary channel. See your TV manual for details.</li></ul>
<b>Distorted picture</b>	<ul style="list-style-type: none"><li>– Check the disc for fingerprints. Clean the disc with a soft cloth, wiping from center to edge.</li><li>– Sometimes a small amount of picture distortion may appear. This is not a malfunction.</li></ul>
<b>No sound</b>	<ul style="list-style-type: none"><li>– Check audio connections.</li><li>– If you are using a HiFi amplifier, try another sound source.</li><li>– If you are using a Receiver, select the DVD Player as the sound source at the receiver.</li></ul>
<b>Distorted sound from HiFi amplifier</b>	<ul style="list-style-type: none"><li>– Make sure no audio connections are made to the amplifier's phono input.</li></ul>
<b>No audio at digital output</b>	<ul style="list-style-type: none"><li>– Check the digital connections.</li><li>– Check the settings menu to make sure the digital output is set correctly. See page 14.</li><li>– Check if the audio format of the selected audio language matches your receiver capabilities.</li></ul>
<b>Disc can not be played.</b>	<ul style="list-style-type: none"><li>– Ensure the disc label is facing up.</li><li>– Clean the disc.</li><li>– Check if the disc is defective by trying another disc.</li><li>– Check if the disc is badly scratched or warped (not flat).</li></ul>
<b>No return to start-up screen when disc is removed</b>	<ul style="list-style-type: none"><li>– Reset by switching the DVD Player off, then on again.</li><li>– Check to see if the Program requires another disc to be loaded.</li></ul>
<b>The DVD Player does not respond to the remote control.</b>	<ul style="list-style-type: none"><li>– Aim the remote control directly at the DVD Player.</li><li>– Remove any obstacles between the DVD Player and the remote control.</li><li>– Inspect or replace the batteries in the remote control.</li></ul>
<b>Buttons do not work.</b>	<ul style="list-style-type: none"><li>– In order to completely reset the player, unplug the AC power cord from the AC outlet.</li></ul>
<b>DVD Player does not respond to some operating commands during playback.</b>	<ul style="list-style-type: none"><li>– Operations may not be permitted by the disc. Refer to the instructions or menu of the disc. If  appears, the feature is not available on the disc.</li></ul>
<b>DVD Player cannot read CDs/DVDs.</b>	<ul style="list-style-type: none"><li>– Use a commonly available cleaning CD/DVD to clean the lens before sending the DVD Player for repair.</li><li>– You can only play finalized discs. If you are using CD-Rom, CD-R or CD-RW discs, make sure you have finalized the discs. Refer to your CD Recorder owner's manual for details.</li></ul>

# Appendix

## Speaker Settings

Make the following settings for the built-in 5.1 channel surround decoder.

### Speaker selection

Press SYSTEM MENU. Press ▲/▼ to select 5.1 Speaker Setup, then press ►.

Press ▲/▼ to select one of the following items you want to adjust.

Select a speaker that you want to adjust. (Front speakers, Center speaker, Rear (Surround) speakers or Subwoofer)

**Note:**

– Certain speaker settings are prohibited by the Dolby Digital licensing agreement.

### Volume

- Press ◀▶ to adjust the output level of the selected speaker. (-10dB ~ 0dB)

### Size

- Press ◀▶ to set a mode. (Large, Small or None)
- If you have connected the system to a speaker with a low frequency of 100Hz or below, select "Large."
- If you have connected the system to a speaker without a low frequency of 100Hz or below, select "Small." If you have not connected a subwoofer, always select "Large" for Front speaker (L/R).
- When you do not have a certain speaker connected, select "None."
- Front L/R speaker's size can be set to "Large" or "Small."
- If Front L/R speaker's size is set to "Small," Rear and Center speaker's size can be set to "Small" or "None."  
Subwoofer's size can be set only to "Large."

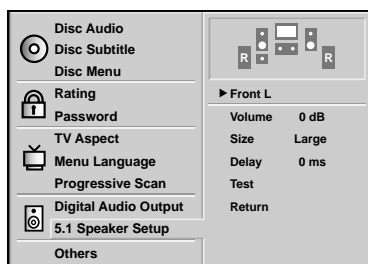

### Delay

- Press ◀▶ to customize the sound to conform to the acoustics of your room by adding a delay effect to the Center Speaker and Rear (Surround) Speakers.
- When 5.1 Channel Surround is played, you can enjoy the best sound if the distance between you and each speaker is the same. You can set the Delay time in the Center/Rear (Surround) Speakers to customize the sound to the acoustics of your room.

#### – Setting Center Speaker

If the distance of Dc is equal to or longer than Df in the below figure, set the mode as 0ms. Otherwise, change the setting according to the table below.

(A) = Df - Dc

Distance of (A)(cm)	Setting(ms)
34	1
68	2
102	3
136	4
170	5

#### – Setting Rear (Surround) Speaker

If the distance of Df is equal to the distance of Ds in the above, set the mode as 0ms. Otherwise, change the setting according to the table below.

(B) = Df - Ds

Distance of (B)(cm)	Setting(ms)
170	5
340	10
510	15

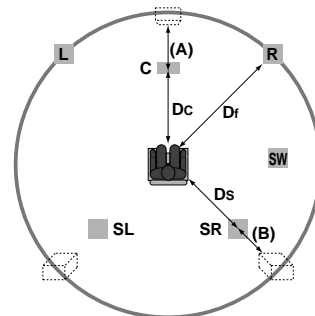

### Test

Press OK to test the signals of each speaker. Adjust the volume to match the volume of test signals memorized in the system.

- Front Left (L) → Front Right (R) → Center → Rear Left (L) → Rear Right (R)

### Return

Press OK to return to the previous menu.



# Specifications

## PLAYBACK SYSTEM

DVD Video  
Video CD and SVCD  
Audio CD (CD-R and CD-RW) and HDCD  
DVD+RW  
MP3

## OPTICAL READOUT SYSTEM

Laser type	FDA CFR21
Numerical Aperture	0.60 (DVD) 0.43 (VCD/CD)
Wavelength	650 nm (DVD) 780 nm (VCD/CD)

## DVD DISC FORMAT

Medium	Optical Disc	
Diameter	12cm (8cm)	
Playing time (12cm)	One layer	2.15 h*
	Dual layer	4 h*
	Two side	4.30 h*
	Single layer	
	Two side	8 h*
Dual layer		

## VIDEO FORMAT

DA Converter	10 bits
Signal handling	Components
Digital Compression	MPEG2 for DVD, MPEG1 for VCD
TV Standard	NTSC
Number of lines	525/60Hz
Playback	Multistandard(PAL/NTSC)

## DVD

Horizontal Resolution	720 pixels
Vertical Resolution	480 lines

## VCD

Horizontal Resolution	352 pixels
Vertical Resolution	240 lines

## VIDEO PERFORMANCE

Progressive scan	
Y Pr/Cr Pb/Cb output	Y: 1 Vpp into 75 ohm Pr/Cr Pb/Cb: 0.7 Vpp into 75 ohm
Video output	1 Vpp into 75 ohm
S-Video output	Y: 1 Vpp into 75 ohm C: 0.286 Vpp into 75 ohm

## AUDIO FORMAT

Digital	MPEG/AC-3/DTS/ PCM	Compressed Digital, 16, 20, 24 bits fs, 44.1, 48, 96 kHz
---------	-----------------------	--

Analog Sound Stereo  
Dolby Surround downmix from Dolby Digital multi-channel sound  
3D Sound on two speakers

## AUDIO PERFORMANCE

DA Converter	24 bits	
DVD	fs 96 kHz	4 Hz - 44 kHz
	fs 48 kHz	4 Hz - 22 kHz
Video CD	fs 44.1 kHz	4 Hz - 20 kHz
	fs 44.1 kHz	4 Hz - 20 kHz
SVCD	fs 44.1 kHz	4 Hz - 20 kHz
	fs 48 kHz	4 Hz - 22 kHz
Signal-Noise (1kHz)		100 dB
Dynamic Range (1kHz)		95 dB
Crosstalk (1kHz)		90 dB
Distortion and Noise (1kHz)		0.008%

## CONNECTIONS

Progressive Scan (On Y Pr/Cr Pb/Cb)	
Y Output	Cinch (green)
Pr/Cr Output	Cinch (red)
Pb/Cb Output	Cinch (blue)
S-Video Output	Mini DIN, 4 pins
Video Output	Cinch (yellow)
Audio left/right output	Cinch (white/red)
<b>6 Channel Analog Output</b>	
Audio Front Left/Right	Cinch (white/red)
Audio Surround Left/Right	Cinch (white/red)
Audio Center	Cinch (black)
Audio Subwoofer	Cinch (black)
Digital Output	1 coaxial, 1 optical IEC958 for CDDA / LPCM IEC1937 for MPEG1/2, AC-3, DTS

## POWER SUPPLY

Power Inlet	120V, 60Hz
Power usage	16 Watt
Power usage standby	less than 3 Watt

## CABINET

Dimensions (w x h x d)	16.93 x 4.65 x 16.18 inch 430 x 118 x 411 mm
Weight	Approx. 12.6 pounds Approx. 5.7 Kg

## GENERAL FUNCTIONALITY

Stop / Play / Pause  
Fast Forward / Backward  
Time Search (DVD)  
Step Forward/Backward  
Slow Motion  
Title / Chapter / Track Select  
Skip Next / Previous  
Repeat (Chapter / Title) or (Track / All)  
A-B Repeat  
Random (Shuffle)  
Enhanced ease of use graphical interface  
Zoom (6 steps)  
3D Surround Sound  
5.1 Channels, user defined speaker settings

## DVD FUNCTIONALITY

Multi-angle Selection  
Audio Selection (1 out of maximum eight languages)  
Subtitles Selection (1 out of maximum 32 languages)  
Aspect Ratio conversion (16:9, 4:3 Letterbox, 4:3 Panscan)  
Parental Control  
Disc Menu support (Title Menu and Root Menu)  
Resume (one disc) after stop / standby  
Marker & Search with Favorite Scene

## VIDEO CD FUNCTIONALITY

Playback Control for VCD 2.0 discs  
Resume (one disc) after stop / standby  
Programming Tracks (PBC Off)

## AUDIO CD FUNCTIONALITY

Time Display (Track)  
Full audio functionality with remote control  
Programming with Favorite Track Selection

## MP3 FUNCTIONALITY

Time Display (Track)  
Programming with Favorite Track Selection

\* typical playing time for movie with two spoken languages and three subtitle languages.

Specifications subject to change without prior notice.

\* This product is covered by one or more of the following patents: In the USA: 5,479,168, 5,638,074, 5,640,161, 5,808,574, 5,838,274, 5,824,600, 5,864,311 and 5,872,531. In Australia: 669114. Other patents pending.

# Limited Warranty

---

## DVD-Video Player/5-Disc Changer

90 days Free Exchange / 91 days–One Year Reduced-Cost Exchange

### WHO IS COVERED?

You must have proof of the date of purchase to exchange your product. A sales receipt or other document showing the date that you purchased the product is considered such proof.

### WHAT IS COVERED?

Warranty coverage begins the day you buy your product. For 90 days thereafter, you may exchange the defective product for a new or renewed product at the store from which it was purchased or through Philips. Either exchange is made at no cost to you.

From 91 days to one year from the date of purchase, you will pay a preset exchange fee to obtain a new or renewed product. Follow the exchange procedures on the next page. This exchange opportunity ends one year after the date of purchase. The replacement product is covered only for the warranty period of the original product. When the warranty on the original product expires, the warranty on all replaced products also expires.

### WHAT IS EXCLUDED?

Your warranty does not cover:

- shipping charges to return defective product.
- labor charges for installation or setup of the product, adjustment of customer controls on the product, and installation or repair of antenna systems outside of the product.
- product repair and/or part replacement because of improper installation, abuse, neglect, misuse, accident, unauthorized repair or other cause not within the control of Philips Consumer Electronics.
- a product that requires modification or adaptation to enable it to operate in any country other than the country for which it was designed, manufactured, approved and/or authorized, or repair of products damaged by these modifications.
- incidental or consequential damages resulting from the product. (Some states do not allow the exclusion of incidental or consequential damages, so the above exclusion may not apply to you. This includes, but is not limited to, prerecorded material, whether copyrighted or not copyrighted.)
- a product that is used for commercial or institutional purposes (including but not limited to rental purposes).

### WHERE IS EXCHANGE AVAILABLE?

Warranty exchange is available in all countries where the product is officially distributed by Philips Consumer Electronics. In countries where Philips Consumer Electronics does not distribute the product, the local Philips service organization will attempt to exchange the product, although there may be a delay if the appropriate product is not readily available.

### MAKE SURE YOU KEEP..

Please keep your sales receipt or other document

showing proof of date of purchase. Attach it to the owner's manual and keep both nearby. Also keep the original box and packing material in case you need to return your product.

### BEFORE EXCHANGING THE PRODUCT..

Please check your owner's manual before exchanging the product. Adjustments of the controls discussed there may save you time and money.

### LIMITATION OF LIABILITY AND REMEDY..

Philips is not liable under any circumstances for any direct, indirect, special, incidental, or consequential damages, howsoever incurred, even if notified of the possibility of such damages.

To the extent permitted by local law, the remedies provided in this warranty statement are your sole and exclusive remedy.

This limited warranty gives you specific legal rights, and you may also have other rights which vary from state/province to state/province.

### TO EXCHANGE YOUR PRODUCT IN THE U.S.A., PUERTO RICO, OR U.S. VIRGIN ISLANDS...

Follow the instructions stated previously in the "What is Covered" section, or refer to the exchange instructions on the next page.

In the U.S.A., Puerto Rico, and U.S. Virgin Islands, all implied warranties, including the implied warranties of non-infringement, merchantability and fitness for a particular purpose, are specifically disclaimed, and to the extent inconsistent with law of the locality of the user, limited in duration to the duration of this express warranty. Because some states do not allow limitations on how long an implied warranty may last, this limitation may not apply to you.

### TO EXCHANGE A PRODUCT IN CANADA...

Please contact Philips at:

1-800-661-6162 (French Speaking)

1-800-363-7278 (English Speaking)

In Canada, this warranty is given in lieu of all other warranties. There are no other warranties, express or implied, including any implied warranties of merchantability or fitness for a particular purpose.

### TO GET OUT-OF-WARRANTY EXCHANGE...

In the U.S.A., Puerto Rico, or U.S. Virgin Islands, contact Philips Service Solutions Group at 1-800-531-0039 to obtain the cost of out-of-warranty exchange.

### REMEMBER...

Please record below the model and serial numbers found on the product. Also, please fill out and mail your warranty registration card promptly. It will be easier for us to notify you if necessary.

MODEL # \_\_\_\_\_

SERIAL # \_\_\_\_\_

# Limited Warranty (cont'd)

## EXCHANGE INSTRUCTIONS

If your product is defective, you may be able to exchange it at the store from which it was purchased. Most stores display a Return Policy. If not, ask the manager or sales associate how many days you have to exchange a product with them. After the store's return period has expired, or if the store does not have an exchange program, you may exchange the product with Philips if you have your original sales receipt.

**To exchange your product with Philips (per the warranty conditions stated previously), remember:**

- If you exchange the product within 90 days of the original purchase, there is no cost to you.
- If you exchange the product more than 90 days after but less than one year after the day of original purchase, contact Philips Service Solutions Group (PSSG) at 1-800-531-0039 to determine the preset cost for exchange.
- After 12 months from the day of original purchase, contact PSSG at 1-800-531-0039 for information regarding out-of-warranty exchange.
- If you do not have your original sales receipt, or if you have any questions, call PSSG at 1-800-531-0039.

**To obtain a replacement product from Philips:**

1. Contact PSSG at 1-800-531-0039 to determine the cost for exchange.
2. Complete the Exchange Form below.
3. Pack the product and its accessories in the original box or a suitable alternative. You will receive replacement accessories with your replacement product. For packing details, call 1-800-531-0039.
4. Put the completed Exchange Form, a copy of the original sales receipt, and the proper payment amount into an envelope. **DO NOT SEND CASH.** Do not staple or clip these items together. Label the envelope "Return Documents Enclosed." Place this envelope in the box with the product.
5. Seal the box with packing tape and return the product via United Parcel Service (UPS), insured and freight prepaid, to:

Philips Recovery Center

Rojas 6

12420 Mercantile Avenue

El Paso, TX 79928

ATTENTION: DVD PLAYER EXCHANGE

A replacement will be sent to you via UPS within 48 business hours of Philips' receipt of the product.

## EXCHANGE FORM

**Your Address (street address to which replacement should be delivered, no P.O. boxes allowed):**

Name: \_\_\_\_\_

Street Address: \_\_\_\_\_

Apt. #: \_\_\_\_\_

City: \_\_\_\_\_

State/Province: \_\_\_\_\_

Zip Code/Postal Code: \_\_\_\_\_

Phone (day): \_\_\_\_\_

Phone (night): \_\_\_\_\_

**Exchange Fee:** \_\_\_\_\_ **+ Sales Tax:** \_\_\_\_\_ **= Total:** \_\_\_\_\_

**Method of Payment:** (Check one. Please, no cash or CODs.)

\_\_\_\_\_ Check/Money order      Check/Money order No. \_\_\_\_\_

	Account number	Expiration date
_____ American Express	_____	_____
_____ Visa	_____	_____
_____ Novus/Discover	_____	_____
_____ Mastercard	_____	_____

**Signature:** \_\_\_\_\_

Detailed reason for return, use additional paper if necessary: \_\_\_\_\_

Model Number \_\_\_\_\_ Serial Number \_\_\_\_\_

**Remember, the return box should include the following:**

- The product,
- Accessories supplied with the product, and
- Completed Exchange Form and sales receipt,
- Payment, if applicable.

**PHILIPS CONSUMER ELECTRONICS COMPANY**

A Division of Philips Electronics North America Corporation, Knoxville, Tennessee 37914-1810, USA

DVD972C



IB8310E002



The products and services described herein are not necessarily available in all countries.  
Due to continuous product improvements, this document is subject to change without notice.

Printed in Korea  
SL-0109/17-1  
P/N: 3834RS0018A