

Panasonic®

DVD VIDEO RECORDER

Operating Instructions

Model No. **LQ-DRM200**

FOR PROFESSIONAL USE ONLY

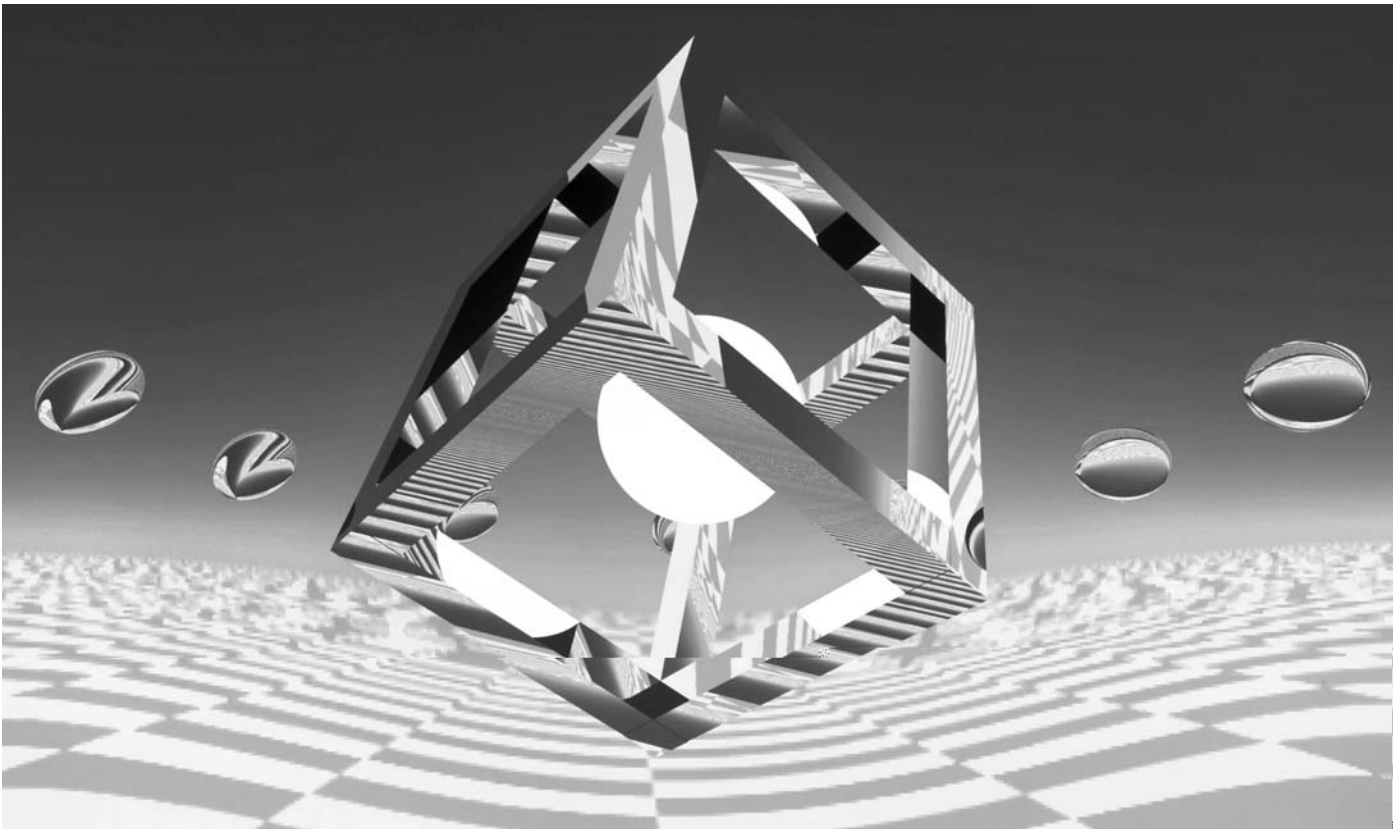

Dear customer

Thank you for purchasing this product. For optimum performance and safety, please read these instructions carefully.

Before connecting, operating or adjusting this product, please read these instructions completely. Please keep this manual for future reference.



Region number supported by this unit

Region numbers are allocated to DVD players and software according to where they are sold.

- The region number of this unit is "1".
- The unit will play DVDs marked with labels containing "1" or "ALL".

Example:



For U.S.A. only

The warranty can be found on page 59.

**Before moving the unit, ensure that the unit is stable.
Failure to do so will risk severe damage to the unit.**

U.
IEC
DUV
N
DE
AP
AB
LASER
UNG FOR STRA
UNSICHTBARE LASERSTRAH
ICHT DEM STRAHL AUSETZEN.
有可见及不可见激光辐射。避免激光
を聞くとき可視及び不可視のレーザー光が出ます
ームを直視したり、触れたりしないでください。

IMPORTANT SAFETY INSTRUCTIONS

Read these operating instructions carefully before using the unit. Follow the safety instructions on the unit and the applicable safety instructions listed below. Keep these operating instructions handy for future reference.

- 1) Read these instructions.
- 2) Keep these instructions.
- 3) Heed all warnings.
- 4) Follow all instructions.
- 5) Do not use this apparatus near water.
- 6) Clean only with dry cloth.
- 7) Do not block any ventilation openings. Install in accordance with the manufacturer's instructions.
- 8) Do not install near any heat sources such as radiators, heat registers, stoves, or other apparatus (including amplifiers) that produce heat.
- 9) Do not defeat the safety purpose of the polarized or grounding-type plug. A polarized plug has two blades with one wider than the other. A grounding-type plug has two blades and a third grounding prong. The wide blade or the third prong are provided for your safety. If the provided plug does not fit into your outlet, consult an electrician for replacement of the obsolete outlet.
- 10) Protect the power cord from being walked on or pinched particularly at plugs, convenience receptacles, and the point where they exit from the apparatus.
- 11) Only use attachments/accessories specified by the manufacturer.
- 12) Use only with the cart, stand, tripod, bracket, or table specified by the manufacturer, or sold with the apparatus. When a cart is used, use caution when moving the cart/apparatus combination to avoid injury from tip-over.
- 13) Unplug this apparatus during lightning storms or when unused for long periods of time.
- 14) Refer all servicing to qualified service personnel. Servicing is required when the apparatus has been damaged in any way, such as power-supply cord or plug is damaged, liquid has been spilled or objects have fallen into the apparatus, the apparatus has been exposed to rain or moisture, does not operate normally, or has been dropped.



Features

This unit allows recording of high quality video on DVD-RAM, the compact and durable digital media with fast random access. This media also out performs past tape formats in ease of operation.

■ DV Automatic Recording (→page 15)

Connect the digital video camcorder with the DV input. Once you begin recording on DVD-RAM using DV input automatic recording, a playlist is automatically created which is very convenient for editing. (You cannot connect a personal computer to the unit.)

■ Editing your recording **RAM**

- You can divide programs (→page 32).
- Use play lists (→page 28) to select your favorite scenes and rearrange them to play in any order you like.

■ Enjoy still pictures (JPEG/TIFF) (→pages 18 and 19, 34–37)

- It is possible to display still pictures (→page 11) taken with a digital camera either in a list or one by one.
- It is possible to save still pictures from a memory card onto DVD-RAM.
- You can set the number of still pictures (DPOF) on the memory card for automated printing at a photo developing store or on your home printer.

■ Exceptional sound and picture quality when recording

- Audio is recorded using Dolby Digital stereo, enabling high quality sound recordings. When recording in XP mode it is possible to use LPCM (2 channel) to achieve sound recordings of even higher quality.
- The encoder system used for recording is called "Hybrid VBR" and allows high quality recordings.

■ Fast access to the program you want to watch (→page 17) **RAM DVD-R**

Use the Direct Navigator to find a program you have recorded and start play.

■ Make your own DVD-Video

- Finalizing a DVD-R that has been recorded on produces an original DVD-Video in accordance with DVD-Video standards.
- In addition to DVD-Video movie software, this unit can also play other types of discs including audio CDs and Video CDs. This means that this unit has the potential to play a central role in your home entertainment, from high-end home theater through to CD playback.

■ Maximum 12 hours on DVD-RAM

- Using a double sided, 9.4 GB DVD-RAM allows you to record a maximum of 12 hours (6 hours continuously).
- You can also use the FR (Flexible Recording) mode to fit recordings efficiently onto the available space on the disc.

■ MP3 disc play (→page 22)

You can also play MP3 files recorded on CD-R and CD-RW, as well as DVD-RAM, DVD-R, DVD-Audio, DVD-Video, Video CDs and CDs.

■ Progressive Scan

By connecting the component video terminals of this unit to a progressive scan television, it is possible to enjoy the high quality picture rendered by the progressive scan function.

■ Quick View (→page 21)

You can speed up play to make checking the contents faster. Both video and sound are played faster.

■ The FUNCTIONS window shows you most of the features you can use (→page 42)

The FUNCTIONS window has most of the features and functions you are likely to use regularly. Just select the icon for the operation you want to perform.

■ Watch a program while you are recording it (→page 23) **RAM**

Chasing Play

You can watch a program from the start while you are still recording it.

Simultaneous rec and play

You can record a program while watching one you recorded previously.

Time Slip

You can jump back to review a piece of action you missed while recording by pressing the time slip button.

- During playback, you can specify a length of time to jump to the scene you wish to view.

The manufacturer accepts no responsibility and offers no compensation for loss of recorded or edited material due to a problem with the unit or recordable media, and accepts no responsibility and offers no compensation for any subsequent damage caused by such loss.

Examples of causes of such losses are

- A disc recorded and edited with this unit is played in a DVD recorder or computer disc drive manufactured by another company.
- A disc used as described above and then played again in this unit.
- A disc recorded and edited with a DVD recorder or computer disc drive manufactured by another company is played in this unit.

Getting started

IMPORTANT SAFETY INSTRUCTIONS	3
Features	3
Accessories	4

Setting up

STEP 1 Antenna and television connections	5
STEP 2 The remote control	6
STEP 3 Channel and clock setting	6
STEP 4 VCR Plus+ guide channel settings	8
STEP 5 Set up to match your television	9
Disc information	10
SD/PC card and still pictures	11
Control reference guide	12

Recording

Recording television programs	14
Inserting discs	14
Recording the best quality pictures in the remaining time	
—Flexible Recording	15
Watching the television while recording	15
Recording from a video cassette recorder	15
DV Automatic Recording (DV AUTO REC)	15

Playing back

Playing discs	16
When a menu screen appears on the television	17
Position Memory	17
Using the Direct Navigator	17
To erase a program that is being played back	17
Playing still pictures	18
Changing audio	19
Other methods of play	20
Skipping	20
Slow-motion play	20
Frame-by-frame viewing	20
Starting play from a selected item	20
Skipping a minute forward—CM Skip	20
Selecting an amount of time to skip—Time Slip	21
Fast forward and rewind—SEARCH	21
Quick View	21
Marking places to play again—MARKER	21
Using menus to play MP3 discs	22
Playing while you are recording	23
Playing from the beginning of the program you are recording	
—Chasing Play	23
Simultaneous rec and play	23
Reviewing the recorded images while recording	
—Time Slip	23

Timer recording

Timer recording	24
Specify a time to stop recording	24
Using VCR Plus+ codes to make timer recordings	24
Manually programming timer recordings	25
Check programs	26
Change or delete the program	26

Editing

Entering text	27
Creating play lists	28
Playing play lists	29
Playing play list scenes	29
To erase a play list or a play list scene during playback	29
Editing play lists	30
Editing programs	32
Editing still pictures	34
Disc setting	38

Advanced operation

Using on-screen menus	40
Common procedures	40
Disc menu	40
Play menu	41
Audio menu	41
Video menu	41
Using the FUNCTIONS window	42
On-screen displays	43
Changing the unit's settings	44
Summary of settings	44
Common procedures	46
Changing the remote control code	46
Audio channel for DV input	46
Other channel settings	47
Home Theater	48
Connecting a cable TV box/satellite receiver	49
Connecting an amplifier or system component	50
Connecting other video equipment	51
Other antenna connections	52
Other antenna connection to the unit	52
Other antenna connection from the unit to the television	52

Reference

Glossary	53
Disc handling	53
Error messages	54
Troubleshooting guide	55
Maintenance	57
Specifications	58
Product Service	58
Limited Warranty (ONLY FOR U.S.A.)	59
Index	Back cover

Accessories

 Please check and identify the supplied accessories. Use numbers indicated in parentheses when asking for replacement parts.
Only for U.S.A.: To order accessories contact 1-800-833-9626.
Only for Canada: To order accessories, call the dealer from whom you have made your purchase.

1 Remote control
(EUR7624KG0)



1 AC power supply cord
(VJA0488)



1 75 Ω coaxial cable
(VJA1091)



2 Batteries
for remote control



1 Audio/Video cable
(VJA0788)



Note

The included AC power supply cord is for use with this unit only. Do not use it with other equipment.

STEP 1 Antenna and television connections

Preparation

- Refer to the television's operating instructions.
- Turn the television off and disconnect its AC power supply cord.

To enjoy sound through other audio equipment (→page 50)

To enjoy progressive video

Connect to the component video (480P) input terminals on a television compatible with this unit's copy guard system. (Video will not be displayed correctly if connected to an incompatible television.)

- All Panasonic televisions that have 480P input terminals are compatible. Consult the manufacturer if you have another brand of television.

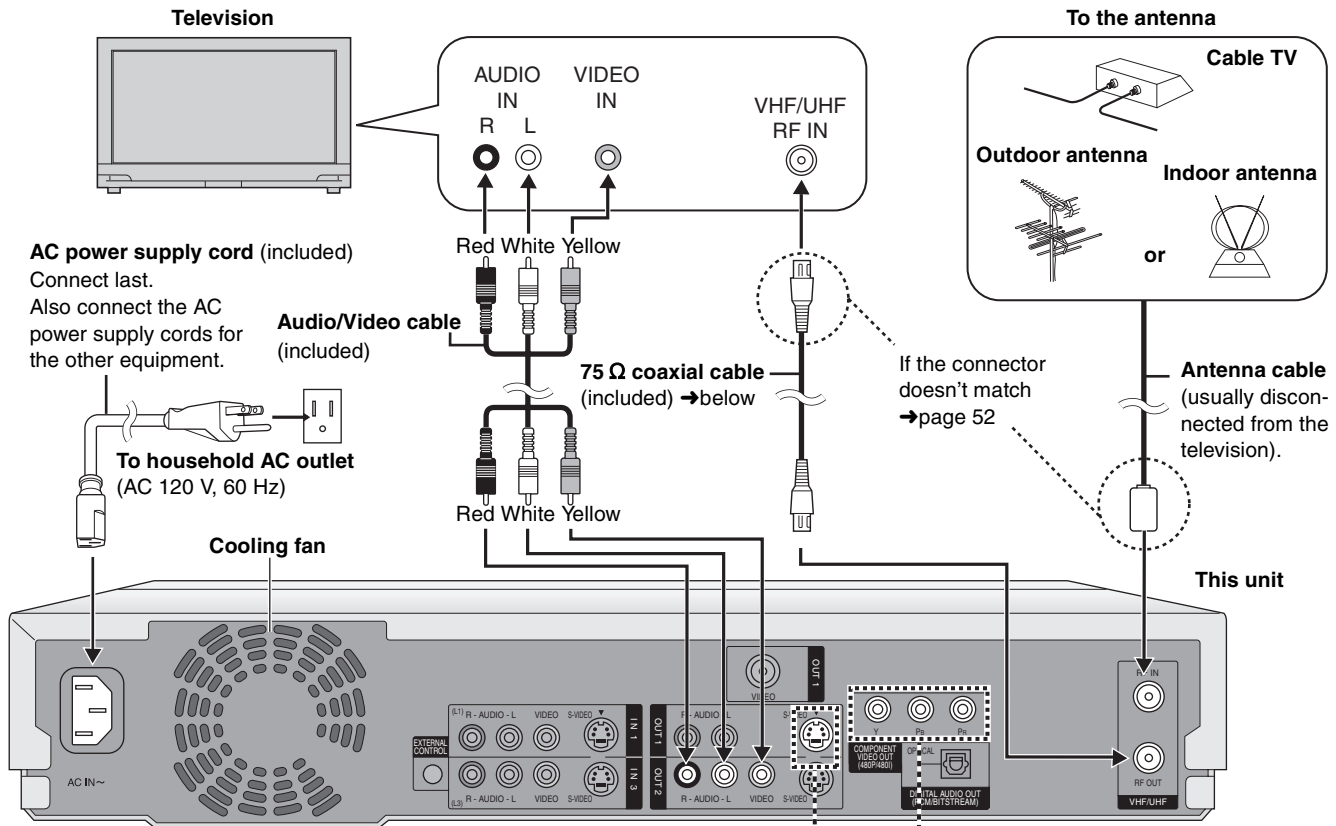

S-VIDEO OUT terminal

The S-VIDEO OUT terminal achieves a more vivid picture than the VIDEO OUT terminal by separating the chrominance (C) and luminance (Y) signals. (Actual results depend on the television.)

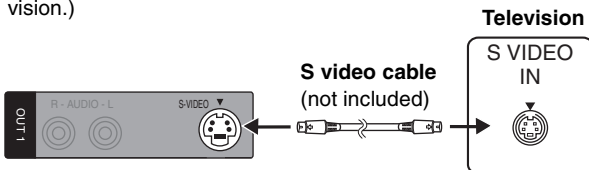

When making this connection, ensure you connect the audio cables to the corresponding audio input terminals on the television.

75 Ω coaxial cable

- The signal from the antenna passes through this unit and along the 75 Ω coaxial cable to the television even when this unit is turned off. You don't have to connect the antenna to the television.
- The picture and sound signal from this unit does not go through the 75 Ω coaxial cable to the television. Make sure you connect one of the following terminals on this unit to the television: the AUDIO/VIDEO terminals, the S-VIDEO OUT terminal or the COMPONENT VIDEO OUT terminals. If the television has none of these terminals, consult your local dealer.

Conserving power

This unit consumes a small amount of power, even when it is turned off (approx. 3.2 W). To save power when the unit is not to be used for a long time, unplug it from the household AC outlet.

Television

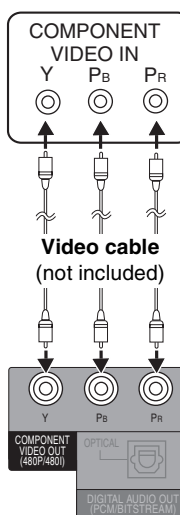

COMPONENT VIDEO OUT terminals

These terminals can be used for either interlace or progressive output and provide a purer picture than the S-VIDEO OUT terminal.

Connection using these terminals outputs the color difference signals (P_B/P_R) and luminance signal (Y) separately in order to achieve high fidelity in reproducing colors.

- The description of the component video input terminals depends on the television or monitor (e.g. Y/P_B/P_R, Y/B-Y/R-Y, Y/C_B/C_R). Connect to terminals of the same color.

- After making this connection, change the black level for a better picture (→page 45, Video-Black Level Control).

When making this connection, ensure you connect the audio cables to the corresponding audio input terminals on the television.

Do not connect the unit through a video cassette recorder

Video signals fed through video cassette recorders will be affected by copyright protection systems and the picture will not be shown correctly on the television.

STEP 2 The remote control

Batteries

Opening the rear cover.

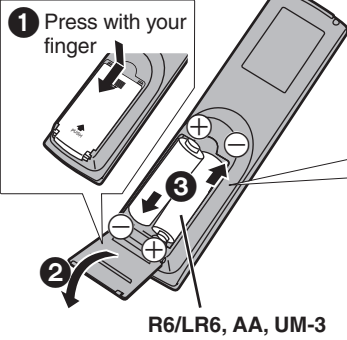

Closing the rear cover.



R6/LR6, AA, UM-3

● When the cover comes off

- Insert so the poles (+ and -) match those in the remote control.
- Do not use rechargeable type batteries.

Do not:

- mix old and new batteries.
- use different types at the same time.
- heat or expose to flame.
- take apart or short circuit.
- attempt to recharge alkaline or manganese batteries.
- use batteries if the covering has been peeled off.

Mishandling of batteries can cause electrolyte leakage which can damage items the fluid contacts and may cause a fire.

Remove if the remote control is not going to be used for a long period of time. Store in a cool, dark place.

Note

If you cannot operate the unit or television using the remote control after changing the batteries, please re-enter the codes (television →page 9, main unit →page 46).

Use

Remote control signal sensor

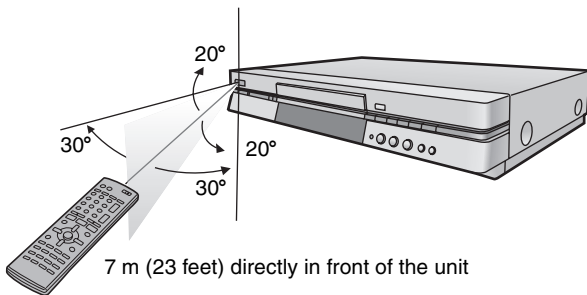

7 m (23 feet) directly in front of the unit

STEP 3 Channel and clock setting

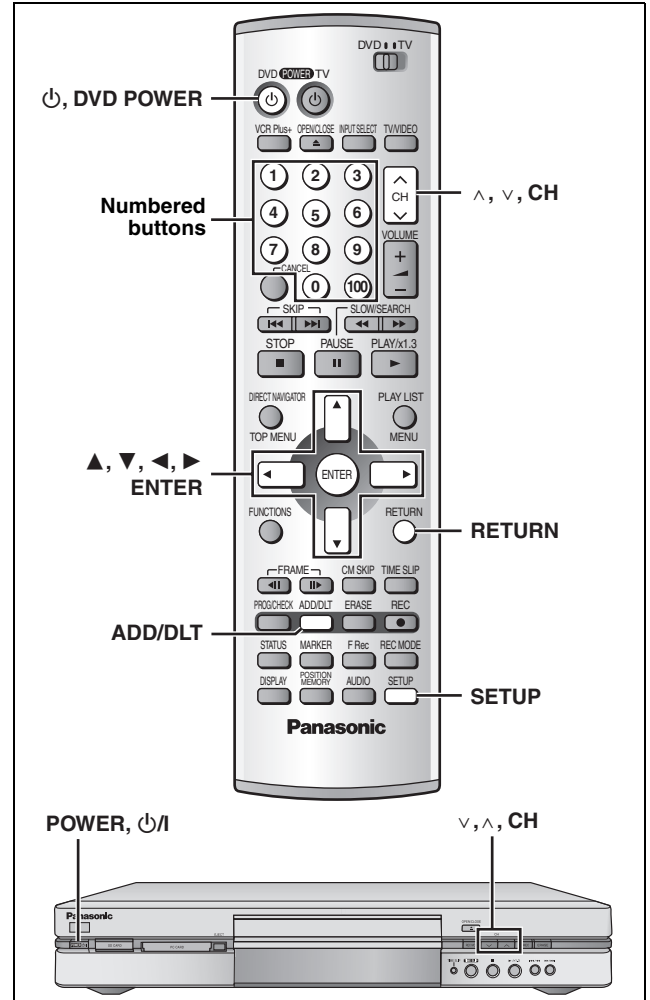

In accordance with the Antenna System (TV or CATV) setting, channels will be set as shown in the tables below.

	Band	Channel
TV Mode (Airwave)	VHF	2-13
	UHF	14-69
CATV Mode (Cable)	VHF	2-13
	CATV LOW BAND	95-99
	CATV MID/SUPER BAND	14-36
	CATV HYPER BAND	37-65
	ULTRA BAND	66-94 100-125
	SPECIAL CATV CHANNEL	1

Preparation

- Confirm that the antenna is connected correctly.
- Turn on the television and select the appropriate video input to suit the connections to this unit.

1 Press [POWER, DVD POWER] to turn the unit on.

2 Press [SETUP] to show the menus.

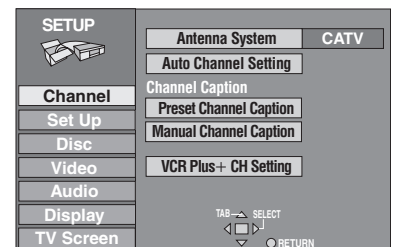

- Press [▲, ▼] to select “Channel” and press [▶].

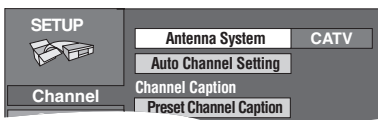

- Press [▲, ▼] to select “Antenna System” and press [ENTER].

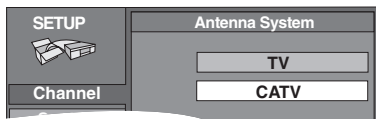

- Press [▲, ▼] to select “TV” or “CATV” and press [ENTER].

The screen shown in step 3 reappears.

- Press [▲, ▼] to select “Auto Channel Setting” and press [ENTER].

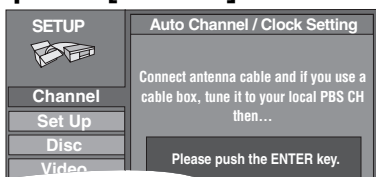

- Press [ENTER].

Auto setting starts. This takes a few minutes. (To stop auto channel setting, press [RETURN].)

If you have not set the clock, the unit will carry out Auto Clock Setting. The time is displayed when finished.

- Press [ENTER] to end the setting.

- After carrying out Auto Channel Setting, make sure you re-set VCR Plus+ guide channel (→page 8) and Channel Caption (→page 47).

Notes on Auto Clock Setting

- If you connect the unit through a cable TV box or DSS receiver (→page 49) and the Auto Channel Setting is not able to find a local PBS station, the Auto Clock Setting will not work properly. If there is no local PBS channel in your area, set the clock manually.
- If the time was not set correctly, use manual clock setting or time zone adjust.
- DST, Daylight Saving Time, shows the summertime setting.
- TIME ZONE shows the time difference from Greenwich meantime (GMT).
 EST (Eastern Standard Time) = GMT -5
 CST (Central Standard Time) = GMT -6
 MST (Mountain Standard Time) = GMT -7
 PST (Pacific Standard Time) = GMT -8
 AST (Alaska Standard Time) = GMT -9
 HST (Hawaii Standard Time) = GMT -10
 For other areas: xx hr

Time Zone Adjust

Adjust the time zone (-1 or +1) if it was not set correctly with auto clock setting.

You cannot change this setting if you set the clock manually.

- Press [SETUP] to show the menus.
- Press [▲, ▼] to select “Set Up” and press [▶].
- Press [▲, ▼] to select “Time Zone Adjust” and press [ENTER].

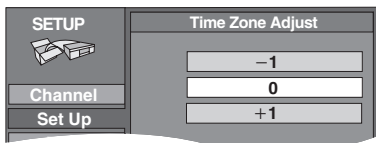

- Press [▲, ▼] to select “-1”, “0”, or “+1” and press [ENTER].

The “Set Up” screen (→ step 2) reappears.

Manual Clock Setting

- Press [SETUP] to show the menus.
- Press [▲, ▼] to select “Set Up” and press [▶].
- Press [▲, ▼] to select “Manual Clock Setting” and press [ENTER].

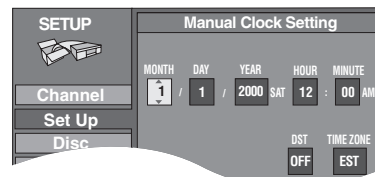

- Press [◀, ▶] to select the item you want to change and press [▲, ▼] to change the setting.

MONTH ↔ DAY ↔ YEAR ↔ HOUR (12-hour display)

TIME ZONE ↔ DST ↔ MINUTE

DST (Daylight Saving Time): ON or OFF

If you select “ON”, the clock is advanced one hour starting at 2 a.m. on the first Sunday in April and ending at 2 a.m. on the last Sunday in October.

TIME ZONE (→left):

EST ↔ CST ↔ MST ↔ PST ↔ AST ↔ HST
 (-5) (-6) (-7) (-8) (-9) (-10)

- Press [ENTER].

The clock starts.

Note

When you change the time zone, the recording times for programs recorded before the time zone was changed also change to correspond to the new time zone.

To return to the previous screen

Press [RETURN].

When you are finished

Press [SETUP].

Adding and deleting channels

Add or delete channels if necessary channels are not set or unnecessary channels are set.

While this unit is receiving the antenna signal (but not during recording):

- Press the numbered buttons to select a channel.

e.g., “5”: [0] → [5]
 “15”: [1] → [5]
 “115”: [100] → [1] → [5]

Unit's display



- You can also use [▲, ▼, CH] when you are going to delete a channel.

- Press [ADD/HLT].

The channel is **deleted** if it was set or **added** if it was not set.

e.g.,



Repeat steps 1 and 2 as necessary.

STEP 4 VCR Plus+ guide channel settings

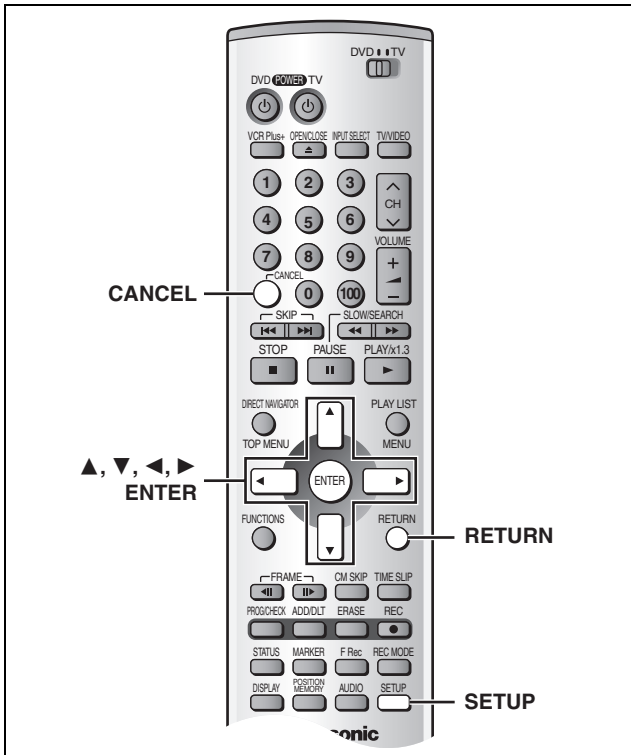

Set these guide channels so you can use VCR Plus+ codes for timer recording. Before starting the settings, prepare a chart showing the channels, station names, and guide channels.

e.g.,

Station name	Guide channel	Channel number	Channel setting (in step 5)
CBS	04	04	Unnecessary
HBO	33	15	Enter channel 15 next to Guide Channel 33.
Nickelodeon	38	20	Enter channel 20 next to Guide Channel 38.

Look up the guide channels for the stations in magazines.

Write down all the stations you can receive.

1 Press [SETUP] to show the menus.

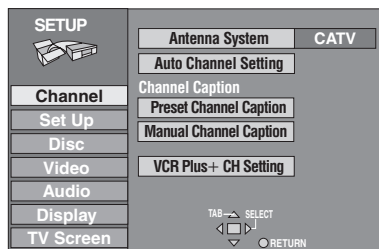

2 Press [▲, ▼] to select “Channel” and press [▶].

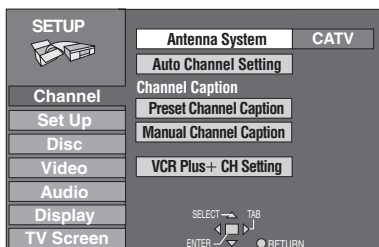

3 Press [▲, ▼] to select “VCR Plus+ CH Setting” and press [ENTER].

e.g., when the current antenna system is CATV.

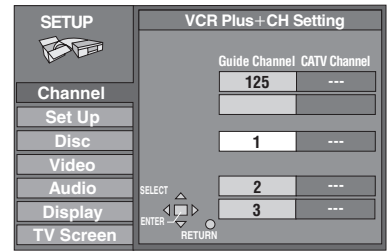

4 Press [▲, ▼] to select the guide channel you want to set and press [▶].

When selecting the guide channel, press and hold [▲, ▼] to scroll the screen up and down.

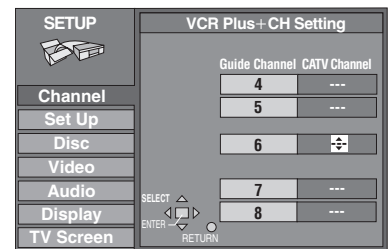

5 Press [▲, ▼] to select the channel corresponding to the guide channel and press [◀].

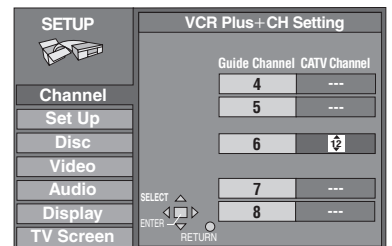

To delete a number, press [CANCEL]. Repeat steps 4 and 5 as necessary.

6 Press [ENTER].

The “Channel” screen reappears.

To return to the previous screen

Press [RETURN].

When you are finished

Press [SETUP].

VCR Plus+ and PlusCode are registered trademarks of Gemstar Development Corporation. The VCR Plus+ system is manufactured under license from Gemstar Development Corporation.

Pats. 5,307,173; 5,335,079; 4,908,713; 4,751,578; and 4,706,121

STEP 5 Set up to match your television

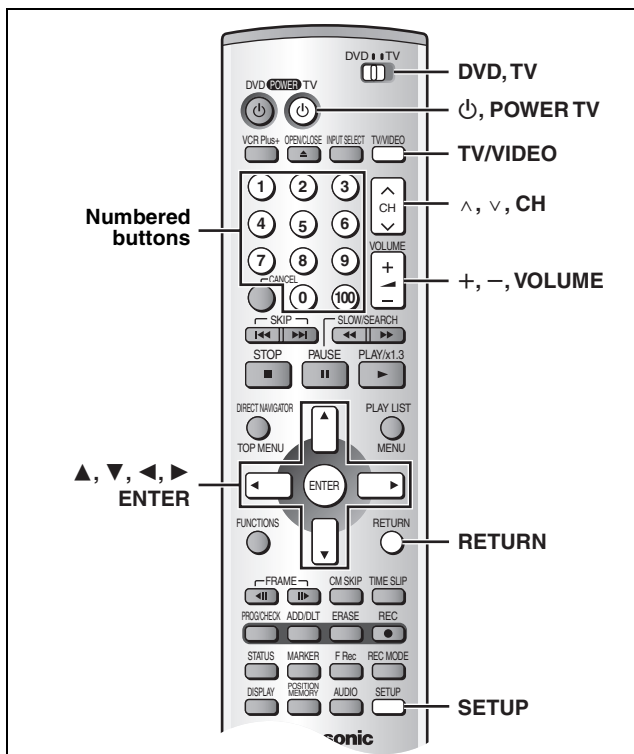

Change the settings if your television is:

- Progressive
 - Read your television's operating instructions for details.
- Widescreen (16:9 aspect ratio)

1 Press [SETUP] to show the menus.

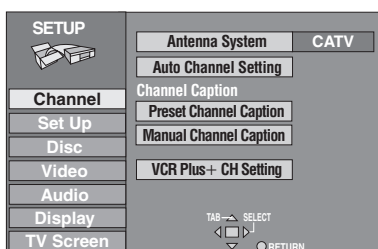

2 Press [▲, ▼] to select "TV Screen" and press [▶].

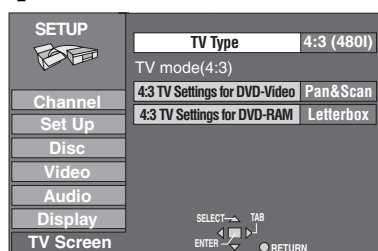

3 Press [▲, ▼] to select "TV Type" and press [ENTER].

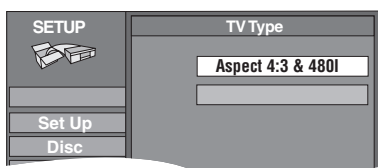

4 Press [▲, ▼] to select the item and press [ENTER].

- If you select a progressive output (480P) item, select Video in the on-screen menu and set "Transfer" to suit the material (→page 41).

To return to the previous screen

Press [RETURN].

When you are finished

Press [SETUP].

■ Regarding Progressive Television Picture

Progressive image aspect (height to width ratio) is set at a standard 16:9. DVD-Video which has been set at 16:9 will be displayed correctly. However, 4:3 video material will be stretched to the right and left when displayed.

• To view the picture at the right aspect

- For televisions that allow the aspect of progressive images to be adjusted, use the function provided on the television and adjust as necessary.
- For televisions which do not allow the aspect of progressive images to be adjusted, please set "Progressive" to "OFF" (→page 41).

Note

- If the unit is connected to the TV through VIDEO OUT or S-VIDEO OUT, output will be interlace only (even if you select progressive output).
- When progressive output is on, closed captions cannot be displayed.

You can control televisions by entering the remote control code.

Press and hold [⏻, POWER TV] and enter the two-digit code with the numbered buttons.

e.g., 01: press [0] → [1].

Code No. and Manufacturer

- Test by turning on the television and changing channels. Repeat the procedure until you find the code that allows correct operation.



Note

If your television brand is not listed or if the code listed for your television does not allow control of your television, this remote control is not compatible with your television.

■ Operation

Point the remote control at the television.

Discs you can use for recording and play

 DVD-RAM 4.7 GB/9.4 GB, 12 cm (5") 2.8 GB, 8 cm (3")	 DVD-R 4.7 GB, 12 cm (5") 1.4 GB, 8 cm (3") for General Ver. 2.0
---	--

- We recommend using Panasonic discs as they have been confirmed to be compatible with this unit. Other discs may not perform correctly.
- Do not allow the disc to become dirty or scratched. Fingerprints, dirt, dust, scratches or deposits of cigarette smoke on the recording surface may make it impossible to use the disc for recording.
- Discs with programs recorded in PAL already cannot be recorded on using this unit.

DVD-RAM

- **DVD-RAM recorded on this unit may not be compatible with other DVD players, including some Panasonic players. Consult the manual for the player to determine compatibility with these DVD-RAM discs.**
- This unit is compatible with both non-cartridge and cartridge DVD-RAM, but the write-protect tabs on cartridge-type discs give better protection to your recordings.
- Picture aspect ratios, regular 4:3 or widescreen 16:9, are recorded as they are received.

DVD-R

- **In order to play a DVD-R recorded using this unit on another playback source, the disc must first be finalized** (→page 38).
- Once a DVD-R is finalized, it becomes DVD-Video.
- You can record onto the available space on the disc and perform editing functions, such as giving titles to discs and programs and erasing programs before finalizing.
- When programming is erased from a DVD-R, that space does not become available. Once an area on a DVD-R is recorded on, that area is no longer available for recording, whether the recording is erased or not.
- It takes about 30 seconds for the unit to complete recording management information after recording finishes.
- This unit optimizes the DVD-R for each recording. Optimizing is carried out when you start recording after inserting the disc or turning on the unit. Recording onto the disc may become impossible if optimizing is carried out too many times.
- Play may be impossible in some cases due the condition of the recording.
- The video is recorded in a 4:3 aspect irrespective of the video signal input.
- A DVD-R recorded on this unit may not be recordable on other Panasonic DVD recorders.

Recording modes and approximate recording times in hours

Mode \ Disc	DVD-RAM		DVD-R (4.7 GB)
	Single-sided (4.7 GB)	Double-sided (9.4 GB)	
XP (High quality)	1	2	1
SP (Normal)	2	4	2
LP (Long play)	4	8	4
EP (Extra long play)	6	12	6

FR (Flexible Recording Mode)

The unit automatically selects a recording rate between XP and EP that will enable the recordings to fit in the available recording time on the disc with the best possible recording quality. You may use FR Mode in either Flexible Recording (→page 15) or in timer recording (→page 24).

Play-only discs

 DVD-Audio ^{*1}	 DVD-Video	 Video CD	 Audio CD ^{*2}
---	---	--	--



*1 Play is in stereo only.

*2 Including discs recorded with MP3.

- The producer of the material can control how DVD-Video and Video CDs are played. This means that you may not be able to control play of a disc with some operations described in these operating instructions. Read the disc's instructions carefully.
- This unit can play CD-R/CD-RW (audio recording disc) recorded with CD-DA (digital audio), video CD (video CD format 2.0 or above) or MP3. Finalize* the disc after recording. Play may be impossible on some CD-R or CD-RW discs due to the condition of recording.
 - * A process that allows play on compatible equipment.
- This unit cannot record onto CD-R or CD-RW.

DVD-Video

Audio format

 DOLBY DIGITAL	Dolby Digital (→page 45) This unit can play Dolby Digital in stereo (2 channels). Connect an amplifier with a built-in Dolby Digital decoder to enjoy surround sound.
 DTS SURROUND	DTS Digital Surround (→page 45) Connect this unit to equipment that has a DTS decoder to enjoy DVDs with this mark.

Discs you can use

The features you can use with the different types of discs are indicated as follows.



- **DVD-R** indicates DVD-R that have not yet been finalized (→page 38). DVD-R that have been finalized can use the same features as DVD-Video. (Refer to features indicated **DVD-V**.)
- **SD/CARD** indicates functions that can use memory cards (→page 11).

Discs that cannot be played

- DVD-Video with a region number other than "1" or "ALL"
- 12-cm (5"), 2.6- and 5.2-GB DVD-RAM
- DVD-RAM not recorded following the Video Recording Standard
- 3.95- and 4.7-GB DVD-R for Authoring
- Unfinalized DVD-R recorded on other equipment
- PAL discs
- DVD-ROM
- DVD-RW
- +RW
- CD-ROM
- CDV
- CD-G
- Photo CD
- CVD
- SVCD
- SADC
- MV-Disc
- PD
- Divx Video Disc, etc.

Protection

RAM

You can protect the contents of your discs in the following ways.

- Cartridge-protect:
 - With the write-protect tab in the protect position, you cannot record to, edit, or erase from the disc. (Type 1, 2, and 4 cartridge discs)
- Program-protect (→page 32)
- Disc-protect (→page 38)

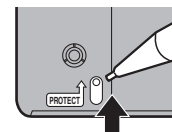

Cards capable of displaying and saving

SD card slot	PC card slot
<ul style="list-style-type: none"> ● SD Memory Card ● Multi Media Card 	<ul style="list-style-type: none"> ● SD Memory Card^{*1} ● Multi Media Card^{*1} ● Compact Flash^{*1} ● Smart Media^{*1} ● Memory Stick^{*1} ● xD picture card^{*1} ● Microdrive^{*1} ● ATA Flash PC card ● Mobile hard disk^{*2*3}

^{*1} A PC card adapter conforming to PC card standards is necessary.

^{*2} Can only play still pictures and save to DVD-RAM.

^{*3} Content saved on SD media storage (SV-PT1).

- **Compatible with:** FAT 12 or FAT 16
- Use this unit to format a memory card when using for the first time (→page 36). Note that the memory card may no longer be usable on other equipment once formatted on this unit.
- This unit operates in accordance with the Digital Print Order Format (→page 36, DPOF). (Card only)
- Only use the memory cards recommended above.

■ Regarding Write Protect

For cards that have a write protect switch, if the switch is on it will not be possible to write, erase or format the card.

■ The card indicator (“SD” or “CARD”) on the display

Only insert or remove the SD/PC card after turning the unit off.

The indicator flashes when the data is being written to or read from the card. Do not turn off the power or remove the card at such a time. Should you do so, the unit may malfunction or the contents of the card may be damaged.

Still pictures

- The unit can play DCF[®] compliant JPEG and TIFF files taken on a digital camera.

^{*}Design rule for Camera File system: unified standard established by Japan Electronics and Information Technology Industries Association (JEITA).

- **Picture definition:**
Compatible in the range 320 × 240 – 6144 × 4096 (sub sampling is 4:2:2 or 4:2:0)
- This unit can handle a maximum of **300 folders** (including header folders) and **3,000 files**. Files and folders with numbers which exceed the maximum cannot be displayed, copied or erased.
- Audio, video and still pictures (MOTION JPEG etc.) that are not compliant with the DCF standard and still pictures other than JPEG and TIFF cannot be displayed.
- Still pictures created or edited on a computer may not be playable.
- TIFF is compatible with uncompressed RGB chunky formats. Other types of TIFF files cannot be played.
- When playing TIFF files, it may take time for them to be displayed.
- When there are a lot of folders and files, it may take a long time to display, copy or erase.
- Folder titles that were input on equipment other than this unit may not be displayed properly.

Still picture folder structure

The following  can be displayed on this unit.

- Folders below  including still pictures within these folders cannot be displayed or saved.

e.g.,

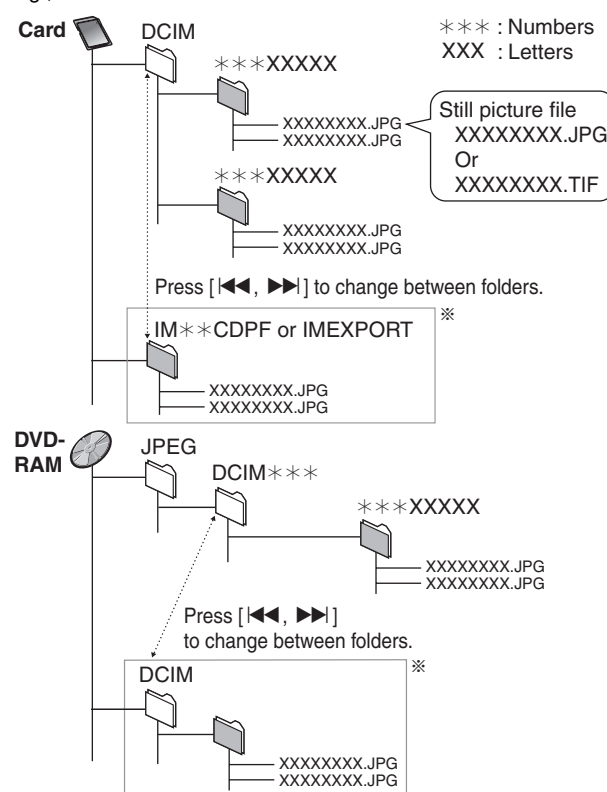

* Folders can be created on other equipment. However, these folders cannot be selected as a copy destination.

- The folder cannot be displayed if the numbers are all “0” (e.g., DCIM000 etc).

Remote control

Setting up

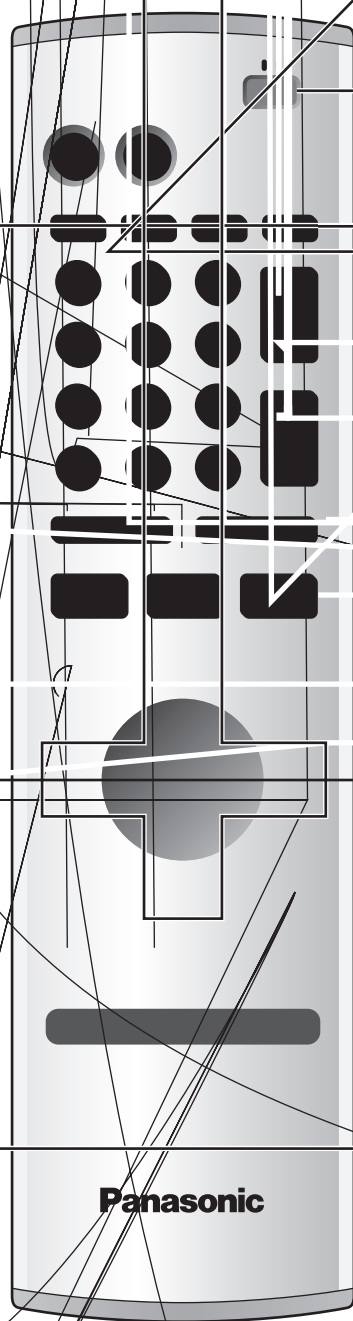

- ① POWER button (⏻, DVD POWER) 6, 14
Press to switch the unit from on to standby mode or vice versa. In standby mode, the unit is still consuming a small amount of power.
- ② VCR Plus+ button (VCR Plus+) 24
- ③ Disc tray open/close button (▲ OPEN/CLOSE) 14
- ④ Numbered buttons (1–9, 0, 100)
- ⑤ Cancel button (CANCEL) 8
- ⑥ Skip buttons (◀◀, ▶▶ SKIP) 20
- ⑦ Stop button (■ STOP) 14
- ⑧ Pause button (⏸ PAUSE) 14
- ⑨ Top menu and Direct Navigator button (TOP MENU, DIRECT NAVIGATOR) 17, 22
- ⑩ Cursor buttons (▲, ▼, ◀, ▶)/Enter button (ENTER) 7
- ⑪ Functions button (FUNCTIONS) 42
- ⑫ Frame advance and frame reverse buttons (◀|||, |||▶ FRAME) 20
- ⑬ Manual programming and check button (PROG/CHECK) 25
- ⑭ Manual channel adding and deleting button (ADD/DLT) 7
- ⑮ On screen display button (STATUS) 43
- ⑯ Marker button (MARKER) 21
- ⑰ On-screen menu button (DISPLAY) 40
- ⑱ Position memory button (POSITION MEMORY) 17
- ⑲ DVD/TV switch (DVD, TV) 9
- ⑳ TV power on/off button (⏻, POWER TV) 9
- ㉑ Television input mode selector (TV/VIDEO) 9
- ㉒ Input select button (INPUT SELECT) 15
- ㉓ Channel buttons for recorder and TV (▲, ▼, CH) 9, 14
- ㉔ TV volume buttons (+, – VOLUME) 9
- ㉕ Slow/search buttons (◀◀, ▶▶ SLOW/SEARCH) 20
- ㉖ Play/quick view button (▶ PLAY/×1.3) 16, 21
- ㉗ Menu and Play list button (MENU, PLAY LIST) 17, 28
- ㉘ Return button (RETURN) 7
- ㉙ Time slip button (TIME SLIP) 21, 23
- ㉚ One-minute skip button (CM SKIP) 20
- ㉛ Recording button (●, REC) 14
- ㉜ Program/play list/still picture erase button (ERASE) 17, 19, 29
- ㉝ Recording mode button (REC MODE) 14
- ㉞ Flexible Recording button (F Rec) 15
- ㉟ Setup button (SETUP) 6
- ㊱ Audio button (AUDIO) 10

Panasonic

Main unit

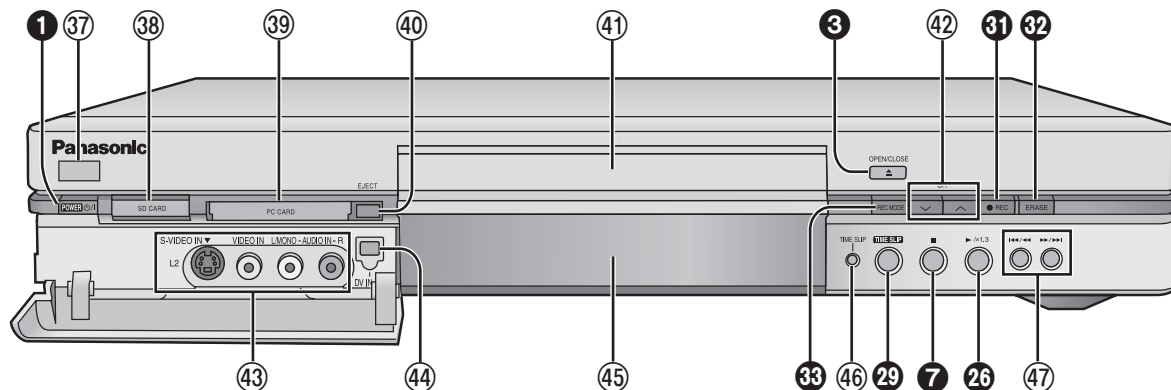

Controls such as ❶ function the same as the buttons on the remote control.

❶ Remote control signal sensor..... 6	❹ L2 input terminals (L2).....51
❷ SD card slot (SD CARD)..... 18	❺ DV input terminal (DV IN)..... 51
❸ PC card slot (PC CARD)..... 18	❻ Display (→below)
❹ PC card eject button (EJECT)..... 18	❼ Time slip indicator (TIME SLIP).....23
❺ Disc tray..... 14	❽ Skip/Slow/Search buttons (⏮/⏪, ⏩/⏭)..... 20, 21
❻ Channel buttons for recorder (▼, ▲, CH)..... 14	

The unit's display

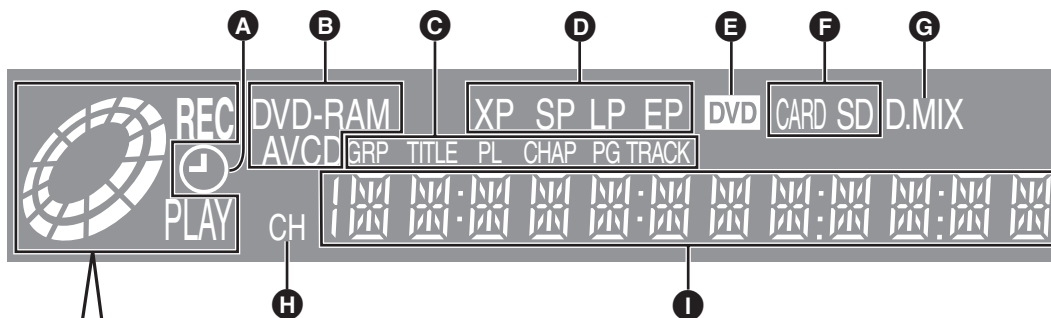

Center circle (e.g., DVD-RAM)
Rotating (REC):recording
Stopped (REC):recording paused

Rotating (REC, PLAY):
 Chasing play or simultaneous
 rec and play is in progress

Rotating (PLAY):playing
Stopped (PLAY):play paused
"PLAY" flashes:
 the resume function (→page 16,
 To stop play) is working



A Timer recording display

On: When timer recording is on standby (→page 24)
Flashes: When the unit couldn't go to timer recording standby

B Disc type

C The display mode of the main display section

GRP: Group number
TITLE: Title number
PL: Play list number
CHAP: Chapter number
PG: Program number
TRACK: Track number

D Recording mode (→page 10)

E DVD indicator

Flashes: When you press [⏻, DVD POWER] to turn the unit off until it actually turns off

F SD/PC Card indicator

On: When a SD card or PC card is set in the unit (→page 18)

Flashes: When a SD card or PC card is being read/written to

G Down-mix indicator

On: When multi-channel recorded DVD-Audio is down-mixed to 2 channels and output.

H Channel

I Main display section

Recording and play counter, and other miscellaneous messages



Recording the best quality pictures in the remaining time—Flexible Recording

The unit calculates a recording rate that enables the recording to fit in the time you set (within the remaining time on the disc) and with the best possible picture quality.

- 1 While stopped
Press [F Rec].
- 2 Press [◀, ▶] to select “Hour” and “Min.” and press [▲, ▼] to set the recording time.
- 3 Press [▲, ▼, ▶, ▶] to select “Start” and press [ENTER].
Recording starts.

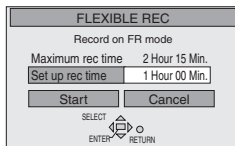

Note

It may not be possible to record to the end of the program if the remaining time doesn't allow.

For your reference

- Press [STATUS] during recording to show the remaining time.
- Recording time reduces if you repeatedly pause recording.
- The recording mode becomes FR.

Watching the television while recording

Pictures being recorded are unaffected.
Switch [DVD, TV] to “TV”.

- 1 Press [TV/VIDEO] to change the television's input mode to “TV”.
- 2 Press [▲, ▼, CH] to change channels.
• You can also select the channel with the numbered buttons.

Recording from a video cassette recorder

Preparation

Connect a video cassette recorder to this unit's input terminals (→page 51).

- 1 While stopped
Press [INPUT SELECT] to select the input channel for the equipment you have connected.
Select L1, L2, L3, or DV.
• You can also select the input channel by pressing [▲, ▼, CH].
- 2 Press [REC MODE] to select the recording mode (XP, SP, LP or EP).
- 3 Start play on the other equipment.
- 4 Press [●, REC] at the point you want to start recording.
Recording starts.

To skip unwanted parts

Press [II] to pause recording. (Press again to restart recording.)

To stop recording

Press [■].

Note

- When recording using L1, L2 or L3 terminals, only the sound received at the time of recording will be recorded.
- The audio recorded through the DV Input terminal is the audio selected in the “Select Audio CH for DV input” (→page 45).
- If flexible recording (→above) is used instead of steps 2 and 4, settings can be made so that recording continues to the end of the video.

DV Automatic Recording (DV AUTO REC)

RAM

Automatic generation of programs and play lists is possible for using the “DV AUTO REC” function when connecting DV equipment (e.g., Digital Video Camcorders) to the DV input terminal on the front of the unit with the DV cable. Recordings from DV camcorders can be recorded to DVD-RAM and DVD-R media, however the “DV AUTO REC” function cannot be used with DVD-R.

Preparation

1. Turn off the main unit and DV equipment, then connect the equipment with the unit's DV input terminal (→page 51).
2. Turn on the main unit and DV equipment.
3. Pause play of the DV equipment at the point you want recording to start.

- 1 While stopped
Press [REC MODE] to select the recording mode (XP, SP, LP or EP).
- 2 Press [FUNCTIONS].
The FUNCTIONS window appears (→page 42).
- 3 Press [▲, ▼, ▶, ▶] to select “DV AUTO REC” and then [ENTER].
DV AUTO REC screen appears.
(The DV equipment pauses automatically if it was playing.)
- 4 Press [◀, ▶] to select “Rec” and then [ENTER].
Recording starts.



When recording finishes

The confirmation screen appears. Press [ENTER] to finish DV auto recording.

To stop recording

Press [■].

Note

- Select the type of audio recording from the Audio menu's “Select Audio CH for DV input” settings (→page 45).
- When “Cannot detect DV connection” is displayed or there is a recording problem confirm the connections, DV equipment settings and reset the power.
If that does not work follow the instructions for “Recording from a video cassette recorder” (→left).
- It is not possible to carry out Chasing play or Simultaneous rec and play of the program that is being recorded.
- The DV equipment name may not be shown correctly.
- You cannot start recording until the images from the DV equipment appear on the television.
- Do not operate the DV equipment during recording, as this will cause recording to stop.
- Recording may not be performed as desired if the time codes on the tape in the DV equipment are not successive.
- During copying, a marker is automatically assigned to points in the original recording where recording was stopped or paused.
- The date and time information on the tape of the DV equipment will not be recorded.
- Depending on the equipment, the DV Automatic Recording may not operate properly.

Almost all videos and DVD software on sale have been treated to prevent illegal copying. Any software that has been so treated cannot be recorded using this unit.

When a menu screen appears on the television

VCD

Switch [DVD, TV] to "DVD" and

Press the numbered buttons (0, 1–9) to select an item.

e.g., "5": [0] → [5]

"15": [1] → [5]

DVD-A DVD-V

Press [▲, ▼, ◀, ▶] to select an item and press [ENTER].

- You may also be able to use the numbered buttons (0, 1–9) to select an item.

Other buttons used to operate menus

Read the disc's instructions for further details about operation.

[▶▶][▶▶/▶▶]: Shows the next menu.

[◀◀][◀◀/◀◀]: Shows the previous menu.

[RETURN]: Shows the menu screen. **VCD**

[TOP MENU]: Shows the first menu screen. **DVD-A DVD-V**

[MENU]: Shows the menu screen. **DVD-V**

Note

- Discs continue to rotate while menus are displayed. Press [■] when you have finished viewing to preserve the unit's motor and your television screen.
- If "⊘" appears on the television, the operation is prohibited by the unit or disc.
- Functions available vary from disc to disc.

Position Memory

RAM DVD-R DVD-A DVD-V VCD CD MP3

You can start play from a memorized position even after turning the unit off.

(When the elapsed play time is displayed)

1 During play

Press [POSITION MEMORY].

The message "Position Memorized" appears on the television.

2 After switching the unit to standby and back on

Press [▶] (PLAY).

Play starts from the memorized position. (The position is cleared.)

Note

DVD-R DVD-A DVD-V VCD CD MP3

- The position is cleared when you open the disc tray.

RAM

- Positions remain memorized even after the disc tray is opened.
- You cannot mark positions if the disc is write-protected.

For your reference

If you press [■] before switching the unit to standby after pressing [POSITION MEMORY] to memorize a position, play will resume from the position you pressed [■] when you press [▶] (PLAY).

Using the Direct Navigator

RAM DVD-R

A list of programs is created as you record them. You can use this list to find programs to watch.

1 Press [DIRECT NAVIGATOR].

The highlighted program plays in the background.

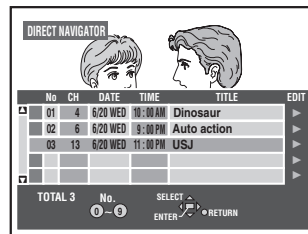

2 Press [▲, ▼] to select the program and press [ENTER].

- You can also select programs with the numbered buttons.
e.g., "5": [0] → [5]
"15": [1] → [5]

Play of the images that were playing in the background continues.

To stop play

Press [■].

To clear the program list

Press [DIRECT NAVIGATOR].

About the program list

Write-protected

Displayed when you have protected the program.

Copy-protected

Displayed when you have recorded a program that has copy protection, from CATV broadcasts, for example.

Unable to play

Displayed if you cannot play the program.

Currently recording

Displayed when the program is being recorded.

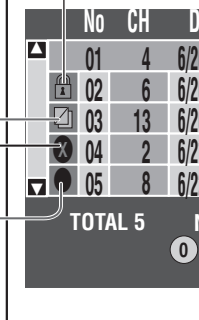

To erase a program that is being played back

RAM DVD-R

Since the program, any play lists (→page 28) created from it are erased irretrievably by this procedure, you should be certain you wish to erase before carrying it out.

1 Press [ERASE].

A confirmation screen will be displayed.

2 Press [◀] to select "Erase" and press [ENTER].

- On the main unit, press [◀◀/◀◀] and [ERASE].

Note

- It is not possible to erase the program when you are carrying out simultaneous rec and play (→page 23). **RAM**
- The amount of space remaining on the disc does not increase even if you erase programs. **DVD-R**
- If the confirmation screen disappears before you complete the operation, start from the beginning again.

To select the next or previous still picture

While in the still picture display, press [◀, ▶].

[◀]: previous still picture [▶]: next still picture

- The still picture changes every time the button is pressed.

To stop still picture display

Press [RETURN].

To display still pictures one by one with constant interval (Slide Show)

The still pictures in the folder will be displayed one by one with a constant interval. The display timing can be altered in units of 1 second.

4 Press [▲, ▼] to select “Slide Show” and press [ENTER].

The still pictures in the folder appear in numerical order.

To change the display timing

- ① After step 3 on the left page, press [▲, ▼] to select “Settings” and press [ENTER].
- ② Press [▲, ▼] to select “Slide Show”.
- ③ Press [◀, ▶] to select the desired timing between still pictures (0 – 30 seconds) (in base units of 1 second).
- ④ Press [ENTER].

To select the next or previous still picture

While in still picture display, press [◀, ▶].

[◀]: previous still picture [▶]: next still picture

- The still picture changes every time the button is pressed.

To stop slide show

Press [RETURN].

To erase still pictures

(Still pictures are erased irretrievably by this procedure.)

While in still picture display

- ① Press [ERASE].
- ② Press [◀, ▶] to select “Erase” and press [ENTER].

To rotate the picture

While in still picture display

- ① Press [ENTER].
- ② Press [▲, ▼] to select “Rotate RIGHT” or “Rotate LEFT” and press [ENTER].

- The still picture as a whole is rotated.
- Rotation information will not be stored.

To display information about the still pictures

While in still picture display, press [ENTER].

(Date, “folder number” - “file number” and number of still pictures are displayed.)

To give a folder a title

After selecting the still picture’s folder in step 3–③ on the left page, press [▶] to select “Folder Title” and press [ENTER]. (→page 27, Entering text):

- Titles inputted using this unit will not be displayed on other equipment.

- SD logo is a trademark.
- Portions of this product are protected under copyright law and are provided under license by ARIS/SOLANA/4C.

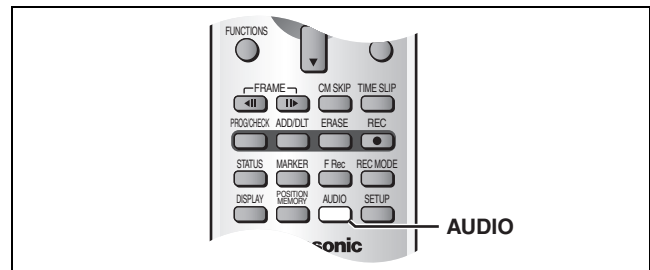

RAM DVD-A DVD-V VCD

You can change the audio being received or played.

Press [AUDIO].

How the type changes depends on when you press the button.

■ While receiving MTS audio (Multi-channel Television Sound Stereo)

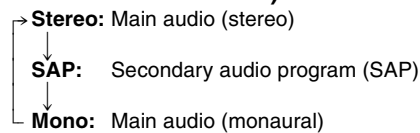

- If the broadcast is “Mono + SAP”, audio will be monaural even if you select Stereo mode.
- Select “Mono” if reception is poor during a stereo broadcast.

e.g., “Stereo” is selected

“(” appears when the unit is receiving the type of audio you selected.



Note

- If you change the sound setting while recording, the recorded sound will also change. **RAM**
- It will not be possible to alter the sound by pressing [AUDIO] in the following cases:
 - When a DVD-R is in the disc tray.
 - When recording mode is XP and “LPCM” has been selected in the Audio menu, “Audio Mode for XP Recording” (→page 45). Select “Main” or “SAP” from “Select MTS” in the Audio menu when recording SAP broadcasts based on the above conditions (→page 45, Audio—Select MTS).

- If recorded in SAP mode, main audio is also recorded. **RAM**

■ While playing DVD-RAM or Video CD

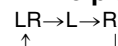

e.g., DVD-RAM

“L R” is selected

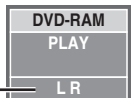

- If it is a recording of an SAP broadcast, each time you press [AUDIO]: **RAM**
MAIN ↔ SAP

For your reference

You can change the audio for the full images being played with simultaneous rec and play and Time Slip. **RAM**

■ While playing DVD-Audio or DVD-Video

You can change the audio channel number each time you press the button. This allows you to change things like the soundtrack language.



e.g., **DVD-V** English is the selected language.

Note

RAM

You may be unable to change the audio when you have connected the unit to an AV receiver through the DIGITAL AUDIO OUT terminal and “Dolby Digital” is set to “Bitstream”. If this occurs:

- Change “Dolby Digital” to “PCM” (→page 45), or
- Connect also with an audio cable (→page 50, **B**) and change the input on the receiver.

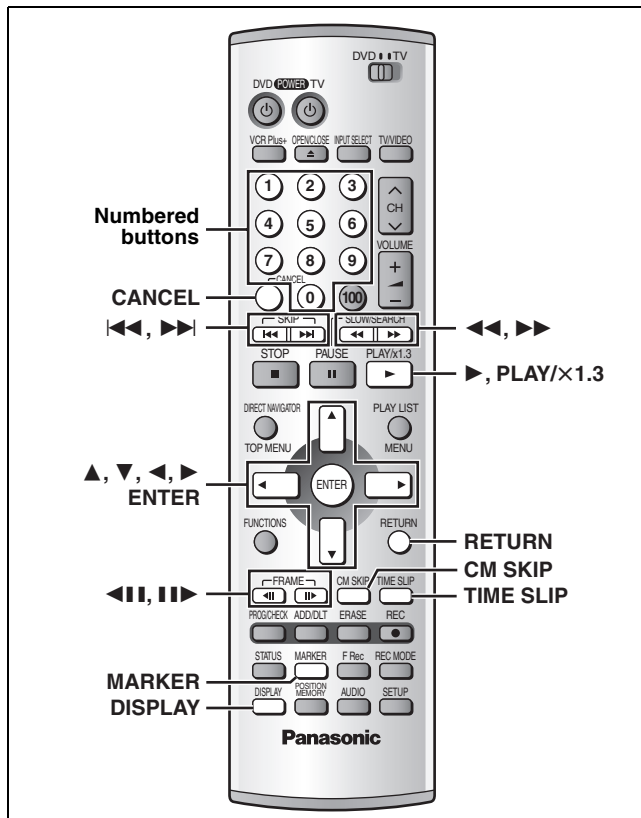

Skipping

RAM DVD-R DVD-A DVD-V VCD CD MP3

During play or while paused
Press [**⏮**] or [**⏭**].

- Press [**⏮**] or [**⏭**] on the main unit.
- Each press increases the number of skips.

DVD-A DVD-V VCD CD MP3

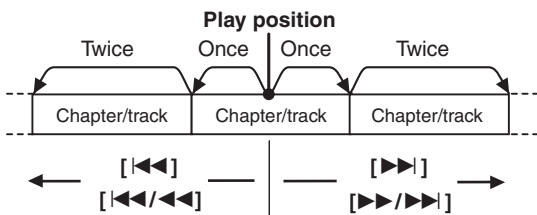

RAM DVD-R

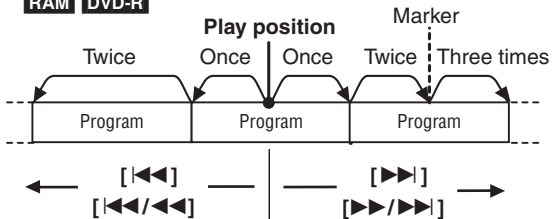

For your reference

- Pressing [**⏮**] [**⏮**] or [**⏭**] [**⏭**] while the playback control feature on Video CDs (→page 53) is working may take you to a menu screen.
- When “PLAY” flashes on the display, the skip function works however, it will not stop at the marker position when playing DVD-RAM or DVD-R.

Slow-motion play

RAM DVD-R DVD-A (Motion picture parts only) DVD-V VCD

While paused

Press [**⏮**] or [**⏭**].

Press and hold [**⏮**] or [**⏭**] on the main unit.

Note

- The speed increases up to 5 steps.
- Press [**▶**] (PLAY) to restart play.
- Backward ([**⏮**] [**⏮**]) does not work with Video CDs.

Frame-by-frame viewing

RAM DVD-R DVD-A (Motion picture parts only) DVD-V VCD

While paused

Press [**⏮**] or [**⏭**].

Note

- Each press shows the next frame.
- Press [**▶**] (PLAY) to restart play.
- Cursor buttons [**⏪**, **▶**] are also effective while paused for frame-by-frame viewing.
- Backward ([**⏮**] [**⏮**]) does not work with Video CDs.

Starting play from a selected item

RAM DVD-R DVD-A DVD-V VCD CD MP3

During play or while stopped

Press the numbered buttons to select the item.

e.g., “5”: [0] → [5] MP3 “5”: [0] → [0] → [5]
 “15”: [1] → [5] “15”: [0] → [1] → [5]

Note

- This may not work with some discs.
- This works only when stopped with some discs (the screen saver is on the television).
- **DVD-A**
 - A group number can be specified while the screen saver is displayed.
e.g., “5”: [5]
 - **Playing bonus groups**
Some discs contain bonus groups. If a password screen appears after selecting a group, enter the password with the numbered buttons and press [ENTER]. Refer also to the disc’s jacket.



Skipping a minute forward—CM Skip

RAM DVD-R

During play

Press [**CM SKIP**].

Play restarts from approximately a minute later.

Note

If the start of the next program is within one minute of the point you skipped from, play restarts from the beginning of that program.

Selecting an amount of time to skip— Time Slip

RAM DVD-R

- 1 During play
Press [TIME SLIP].

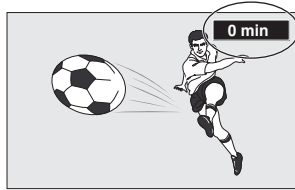

- 2 Within 5 seconds
Press [▲, ▼] to enter the time and then press [ENTER].

e.g., Go back to 5 minutes

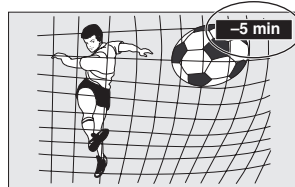

Press to alter in one-minute units. Press and hold to alter in 10-minute units.

Fast forward and rewind—SEARCH

RAM DVD-R DVD-A DVD-V VCD CD MP3

- During play
Press [◀◀] or [▶▶].

• Press and hold [◀◀/▶▶] or [▶▶/▶▶] on the main unit.

Note

- The speed increases up to 5 steps.
- Press [▶] (PLAY) to restart play.
- Audio is heard only while using first level fast forward (other than CD, MP3). You can turn this audio off if you want to (→page 45, Audio—PLAY ×1.3 & Audio during Search).

Quick View

RAM (Only with Dolby Digital)

You can increase the speed of play without disrupting the soundtrack.

- During play
Press and hold [▶] (PLAY/ ×1.3).

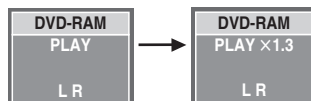

To return to normal speed

Press [▶] (PLAY/ ×1.3).

Note

- Output is in PCM when using a digital connection (→page 50, A).
- This is cancelled when you perform skip, pause, or when play reaches a point where a program recorded in sound other than Dolby Digital starts.
- This does not work if the setting is “Off” in “PLAY ×1.3 & Audio during Search” (→page 45).
- This does not work when recording is in XP or FR mode during simultaneous rec and play (→page 23).

Marking places to play again—MARKER

You can mark positions by pressing [MARKER]. Also use on-screen menus to mark, recall, and clear positions.

RAM DVD-R

Mark up to 999 positions. The unit records the markers directly onto the disc and they remain intact even if you remove the disc.

DVD-A DVD-V VCD CD MP3

Mark up to 5 positions. The markers clear when you open the disc tray.

Marking positions directly

- During play
Press [MARKER].

One marker is added.



Using on-screen menus to mark positions

- 1 During play
Press [DISPLAY].

The on-screen menus appear.

- 2 Press [▲, ▼] to select “Play” and press [▶].

e.g., DVD-RAM



- 3 Press [▲, ▼] to select “Marker” and press [▶] to highlight the first asterisk (*).

RAM DVD-R

DVD-A DVD-V VCD CD MP3



- 4 Press [◀, ▶] to select an asterisk (*) and press [ENTER].

One marker is added.

When marking positions 11 and above

RAM DVD-R

- ① Press [◀, ▶] to highlight “1-10”. 
- ② Press [▲, ▼] to select “11-20”.
You can select the next group of 10 when the current group is full.
- ③ Press [▶].
The first asterisk is highlighted.
- ④ Press [ENTER] to mark a position.

To recall a marker

Press [◀, ▶] to select a marker number and press [ENTER].

- Play starts from the marked position.

To clear markers

Press [◀, ▶] to select a marker number and press [CANCEL].

- An asterisk replaces the number and the position is cleared.

To clear the on-screen menus

Press [RETURN].

Note

- You cannot use this feature if:
 - the disc’s elapsed play time is not shown in the display.
 - you are using a play list. RAM
 - protection (cartridge →page 10, disc →page 38) is set (you can still recall the markers to play a position). RAM
- Subtitles around markers may fail to appear.
- Markers are cleared when you finalize DVD-R (→page 38).
- Markers on DVD-RAM and DVD-R are ordered by time, so marker numbers can change when you add and delete them.

Usir

File list is displayed
▶] to display

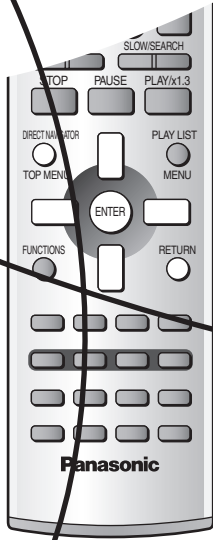

Playing back

2 Press [**▲**, **▼**, **◀**, **▶**] to s
and press [**ENTER**].

The file list for the group appears.

To return to the file list
Press [**RETURN**].

Playing while you are recording

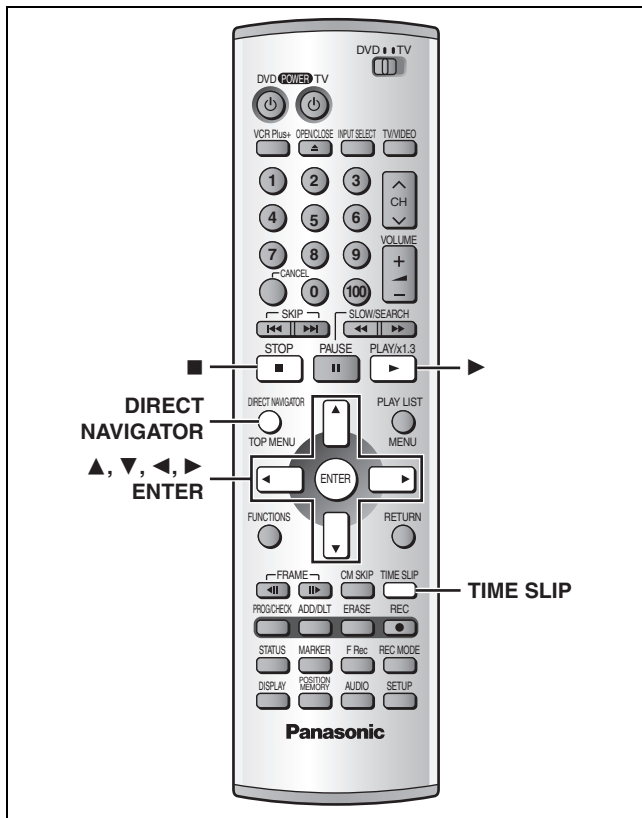

Simultaneous rec and play

RAM

You can play a program previously recorded.

- During recording**
Press [DIRECT NAVIGATOR].
Time slip indicator on the main unit lights.
- Press [▲, ▼] to select a program and press [ENTER].

e.g.,

You want to watch the **movie** you recorded yesterday (program 1) while recording program 2 (sport).

Program 1 is played back while program 2 (sport) is being recorded.

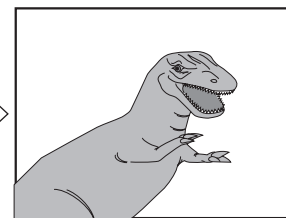
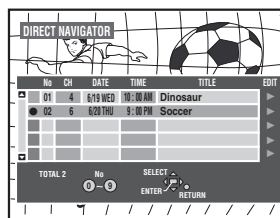

Playing back

Note

- Sound is not output while fast-forwarding.
- You cannot edit programs during simultaneous rec and play (→page 32).

Playing from the beginning of the program you are recording—Chasing Play

RAM

Press [▶] (PLAY).

Play starts from the beginning of the program being recorded. (Time slip indicator on the main unit lights.)

e.g.,

You are recording a **sports program** and you want to watch it from the beginning.

The same **sports program** is played back from the beginning. (Recording continues.)



Note

Sound is not output while fast-forwarding.

To stop play and recording

- Press [■]. (Play stops.)
Wait 2 seconds.
- Press [■]. (Recording stops.)
 - To stop timer recording, press [■], then [ENTER] within 5 seconds.

Reviewing the recorded images while recording—Time Slip

RAM

You can play the program being recorded to check that it is being recorded correctly. You can also check parts that were recorded previously.

1 Press [TIME SLIP].

Time slip indicator on the main unit lights.

Play starts from 30 seconds previous. The current recording images appear as a picture-in-picture and you will hear the playback audio.

- You can select another program if you press [DIRECT NAVIGATOR].

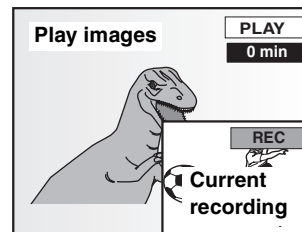

2 Press [▲, ▼] to enter the time and press [ENTER].

- Press [▲, ▼] to alter in one-minute units. Press and hold [▲, ▼] to alter in 10-minute units.



Press [TIME SLIP] to show the play images in full. Press again to show the play and recording images.

Using VCR Plus+ codes to make timer recordings

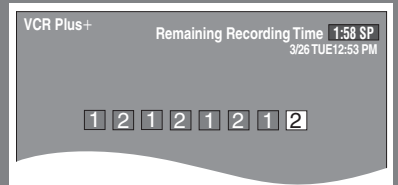
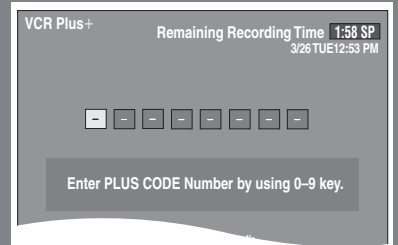
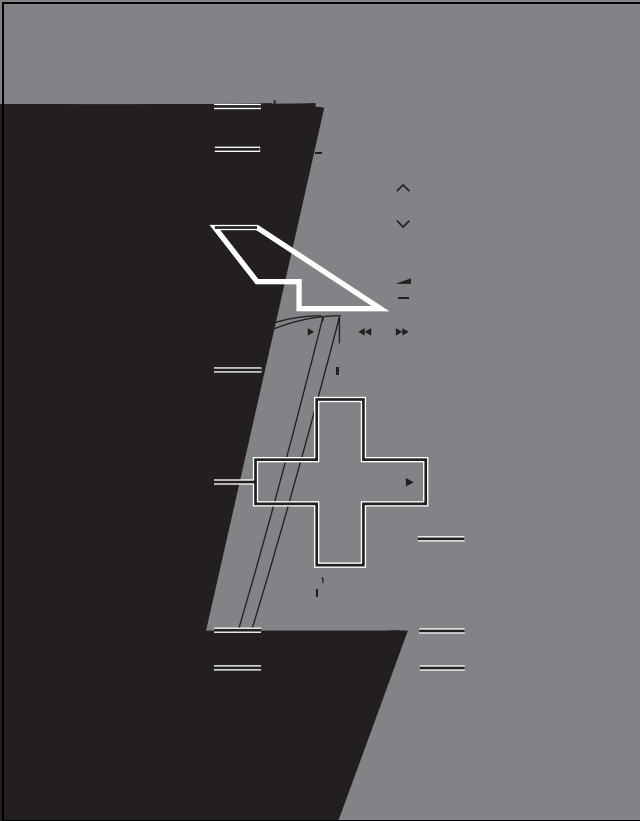

e.g.,

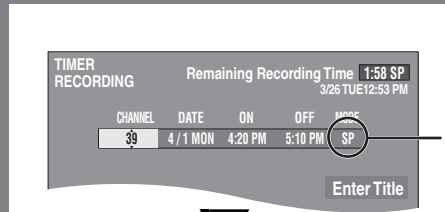
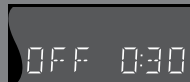

The current recording mode (shown on the unit's display) is automatically selected.

When you press [ENTER]

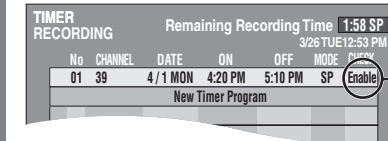

Displayed if the recording can fit in the remaining space on the disc.

Manually programming timer recordings

You can enter up to 16 programs up to a month in advance. Each daily or weekly program is counted as one program.

1 Press [PROG/CHECK].

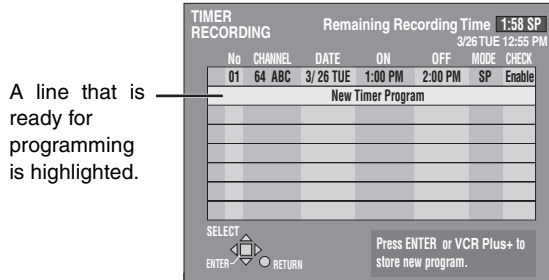

2 Press [ENTER].

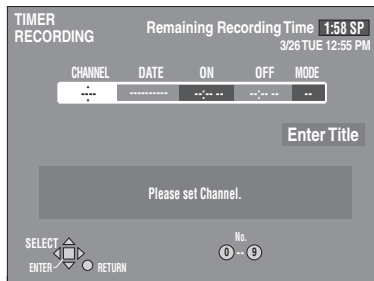

3 Press [▶] to move through the items and change the items with [▲, ▼].

- The current settings are shown each time you press [▶].
- You may use the numbered buttons to enter the CHANNEL, DATE, ON (Start time), and OFF (Finish time).

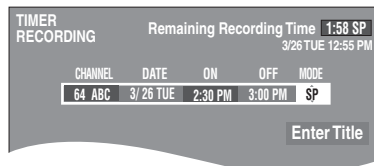

- **CHANNEL (Channel number and caption)**
- **DATE**

→ Current date
 ↓ ↑
 Next day up to one month later minus one day
 ↓ ↑
 Weekly timer: SUN-SAT → MON-SAT → MON-FRI
 ↓ ↑
 → Daily timer: WEEKLY SUN → --- → WEEKLY SAT

- **ON (Start time)/OFF (Finish time)**
 The time increases or decreases in 30-minute increments if you hold the button.
- **MODE (Recording mode → page 10)**
 SP → XP → FR → EP → LP (→ Return to SP)
- **Enter Title**
 Select "Enter Title" using [◀, ▶] and press [ENTER] (→ page 27).

4 Press [ENTER] when you have finished programming the timer.

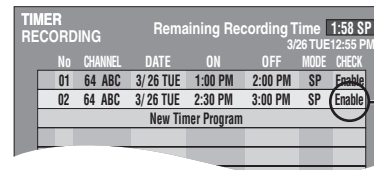

- Press [▲, ▼] to select "New Timer Program" and repeat steps 2–4 to program other recordings.

5 Press [PROG/CHECK] or [RETURN].

The timer recording list disappears and the message "TURN RECORDER OFF FOR TIMER RECORDING." is shown on the television.

6 Press [⏻, DVD POWER].

Ensure "⏻" lights on the unit's display.

To release the unit from recording standby

If you want to record something else before the program start time, for example:

Press [⏻, DVD POWER].

The unit turns on and "⏻" goes out.

- Be sure to press [⏻, DVD POWER] to return the unit to standby mode before the scheduled recording time. Timer recording will work only if "⏻" is displayed.

To cancel recording when recording has already begun

Press [■], then [ENTER] within 5 seconds.

Recording stops.

Note

- The actual time recorded may be longer than the program itself when television programs are recorded using VCR Plus+.
- If you don't select a recording mode when using VCR Plus+ codes to make a timer recording, the unit sets the mode selected on the unit at that time (unless the mode is "XP", in which case the unit sets "FR" as the mode).
- "All timer programs are occupied." appears if there are already 16 programs.
- The remaining time displayed is based on the current recording mode.
- When you program successive timer recordings to start immediately one after the other, the unit cannot record the part at the beginning of the later programs (a few seconds when recording with DVD-RAM and approximately 30 seconds when recording with DVD-R).
- If you set DST (Daylight Saving Time) to ON when manually setting the clock (→ page 7), timer recording may not work when summer switches to winter and vice versa.
- "⏻" flashes when the unit couldn't go to timer recording standby (e.g., a disc isn't loaded, a disc that can't be recorded to is loaded, or the disc is protected). Check the disc carefully.

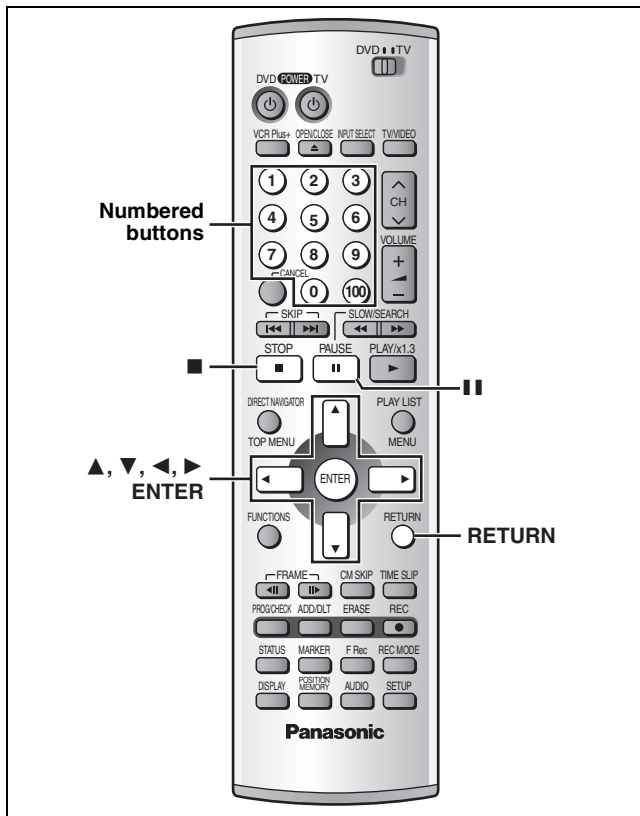

SD/CARD RAM DVD-R

This page shows how to enter text for:

- Program titles for timer recording (→pages 24 and 25)
Program titles (→page 32)
- Play list titles (→page 30)
- Disc titles (→page 38)
- Folder titles of still pictures (→page 35)

You can enter up to:

- 64 characters (DVD-RAM)
– A maximum of 44 characters is possible when inputting a title from the timer recording menu.
- 40 characters for a disc title (DVD-R)
- 44 characters for a program title (DVD-R)
- 36 characters for a folder title of still pictures (card, DVD-RAM)

Preparation

Release protection before proceeding.

Cartridge →page 10, program →page 32, disc →page 38 **RAM**

Write Protect →page 11 **SD/CARD**

- 1 After the titling screen appears
Press [**▲**, **▼**, **◀**, **▶**] to select the character and press [**ENTER**].

Title field: shows the text you have entered

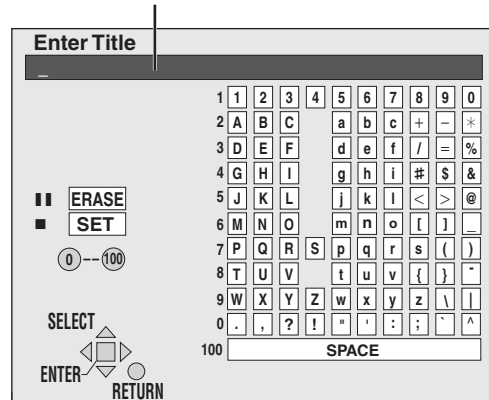

Repeat step 1 to enter other characters.

- 2 Press [**■**].

The title is entered and the screen disappears.

- You can also finish entering the title by selecting "SET" and pressing [**ENTER**].

To end input midway

Press [**RETURN**] (does not save any title information).

Using the numbered buttons to enter characters

e.g., entering the letter "R"

- ① Press [**7**] to move to the 7th row.
- ② Press [**7**] twice to highlight "R".
- ③ Press [**ENTER**].

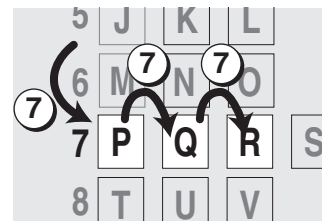

To erase a character

- ① Press [**▲**, **▼**, **◀**, **▶**] to select the character you want to erase in the title field.
- ② Press [**■**].
You can also erase characters by selecting "ERASE" and pressing [**ENTER**].

Note

- The full title is shown in the Properties screen (→page 30 and 32), but if you enter a long title, only part of it is shown in the program list or play list screen.
- If you enter a long title, only part of it is shown in the menu screen after finalization. **DVD-R**
- Still picture folder titles
 - Titles are saved in the "TITLE.DVD" folder and can only be displayed on this unit.
 - Input is not possible if the destination lacks sufficient space or has exceeded the maximum number of allowable files.
 - The title may not appear correctly if input was done using other equipment.

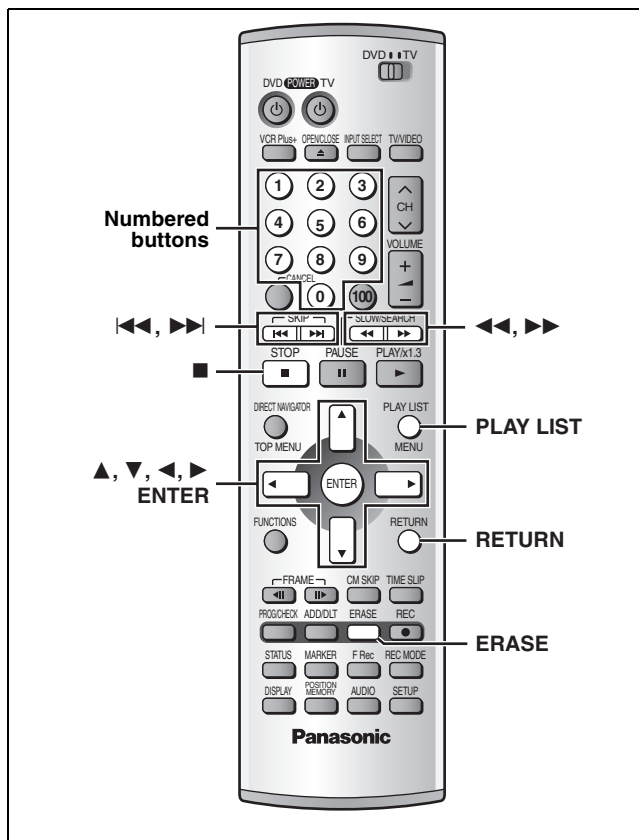

RAM

Specify start and end points to create scenes, then specify the order in which they are to be played. These scenes are not recorded separately so this doesn't use much capacity.

You can create a maximum of 99 play lists and 999 scenes.

Preparation

Release protection (cartridge →page 10, disc →page 38) before proceeding.

- 1** While stopped
Press [PLAY LIST].
- 2** Press [▲, ▼] to select “---/---” and press [ENTER].

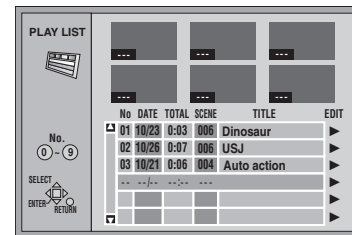

- 3** Press [ENTER] at the start point.

The length of the whole contents on the disc.

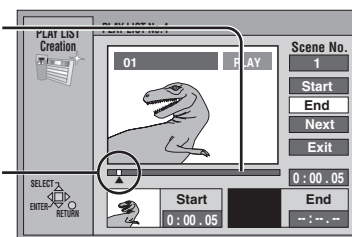

The location of the start point.

- Use [◀], [▶] and slow-motion (→page 20) to find the start and end points.
- Pressing [◀◀], [▶▶] allows you to select other programs.

- 4** Press [ENTER] at the end point.

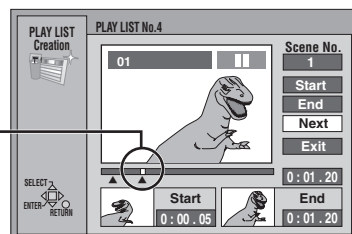

The location of the end point.

To specify another scene

Select “Next” and press [ENTER], then repeat steps 3 and 4.

- 5** Press [▲, ▼] to select “Exit” and press [ENTER].

The play list screen appears.

To clear the play list screen

Press [PLAY LIST].

To stop partway through

Press [RETURN].

For your reference

- You cannot specify an end point before a start point.
- You may not be able to specify points within 3 seconds of each other.
- Play pauses if the end of the last program on the disc is reached during this procedure.
- Depending on the state of recording, the actual number of play lists that can be recorded may be less than that specified in this manual.

Playing play lists

- 1 While stopped
Press [PLAY LIST].

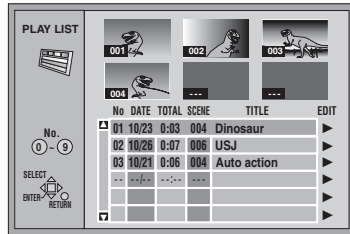

- 2 Press [▲, ▼] to select the play list and press [ENTER].

- You can also select play lists by entering a 2-digit number with the numbered buttons.

e.g., "5": [0] → [5]
"15": [1] → [5]

All the scenes in the play list are played.

To stop play list play

Press [■]. (The play list appears.)

Playing play list scenes

- 1 While stopped
Press [PLAY LIST].
- 2 Press [▲, ▼] to select the play list that contains the scene you want to play and press [▶].

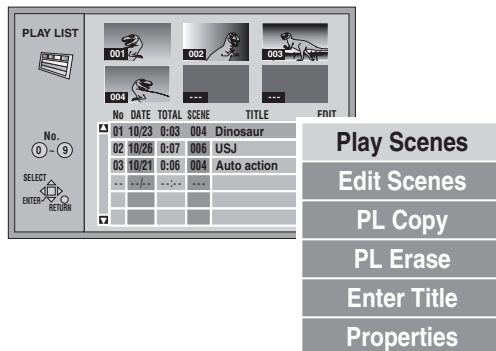

- 3 Press [▲, ▼] to select "Play Scenes" and press [ENTER].

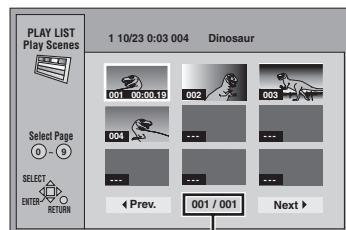

Page no./Total page no.

- 4 Press [▲, ▼, ◀, ▶] to select the scene and press [ENTER].

The scene you select is played.

To show scene 10 and later

Press [▲, ▼, ◀, ▶] to select "Next" and press [ENTER].

- You can also select a page of scenes by entering a 3-digit number with the numbered buttons.

e.g., "5": [0] → [0] → [5]
"15": [0] → [1] → [5]

To stop scene play

Press [■]. (The scene list appears.)

To clear the scene list

Press [RETURN].

To erase a play list or a play list scene during playback

- 1 Press [ERASE].

A confirmation screen will be displayed.

- 2 Press [◀] to select "Erase" or "Yes" and press [ENTER].

RAM

Operation

While stopped
Press [PLAY LIST].

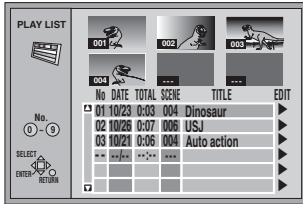

Press [▲, ▼] to select the list.

- To create a new list, select “- -” and press [ENTER] (→ page 28).

Press [▶] so the submenu appears.

Press [▲, ▼] to select the item and press [ENTER].

Play Scenes

→ page 29, Playing play list scenes

Edit Scenes

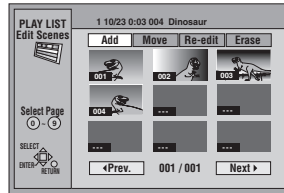

Press [◀, ▶] to select the item (Add, Move, Re-edit or Erase) and press [ENTER].

To show scene 10 and later

- Press [▲, ▼, ▶, ◀] to select “Next” and press [ENTER].
- You can also select a page of scenes by entering a 3-digit number with the numbered buttons.
e.g., “5”: [0] → [0] → [5]
“15”: [0] → [1] → [5]

Editing

PL Copy



Press [◀] to select “Copy” and press [ENTER].

The copied play list appears at the bottom of the list.

PL Erase



Once a play list has been erased, it is irretrievable. Check carefully before proceeding.

Press [◀] to select “Erase” and press [ENTER].

The play list is erased.

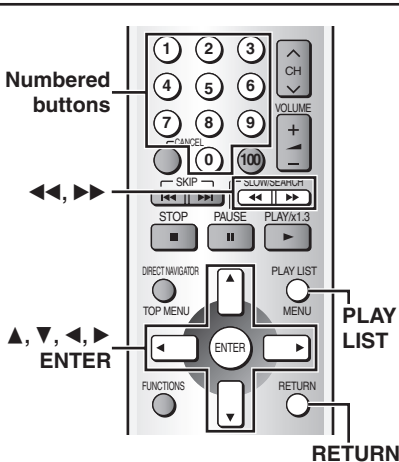

To clear the play list or scene list screen
Press [PLAY LIST].

To stop set up process
Press [RETURN].

For your reference

You can only perform operations for “Play Scenes” and “Properties” if the disc is write-protected. Release protection (cartridge → page 10, disc → page 38) to access other items.

Enter Title

Entering text → page 27

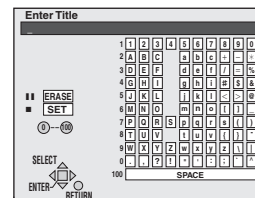

Properties

Play list information (e.g., time and date) is shown.

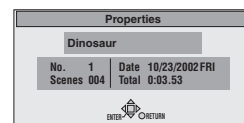

■ Add

Press [▲, ▼, ◀, ▶] to select the place where you want to add the scene and press [ENTER].

Press [ENTER] at the start point of the scene.

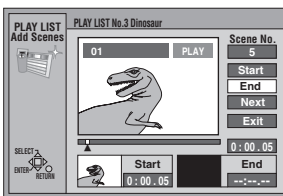

Press [ENTER] at the end point of the scene.

Press [▲, ▼] to select "Exit" and press [ENTER]. The new scene is inserted before the highlighted scene.

Press [▲, ▼] to select "Next" and press [ENTER]. (Repeat to add other scenes.)

■ Move

Press [▲, ▼, ◀, ▶] to select the scene and press [ENTER].

Press [▲, ▼, ◀, ▶] to select the place where you want to move the scene to and press [ENTER]. The scene is moved and inserted before the highlighted scene.

Repeat to move other scenes.

■ Re-edit

Press [▲, ▼, ◀, ▶] to select the scene and press [ENTER].

Press [ENTER] at the start point of the scene.



■ Erase

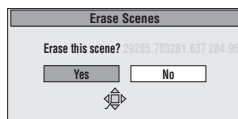

Repeat to erase other scenes.

Note

The play list itself is erased if you erase all the scenes in it.

Note

- Use [◀◀], [▶▶] and slow-motion (→ page 20) to find the start and end points.
- You cannot specify an end point before a start point.
- You may not be able to specify points within 3 seconds of each other.
- Play pauses if the end of the last program is reached during this procedure.
- You cannot edit still picture images.
- Depending on the state of recording, the actual number of play lists or scenes that can be recorded may be less than that specified in this manual.

Operation

Press [DIRECT NAVIGATOR].

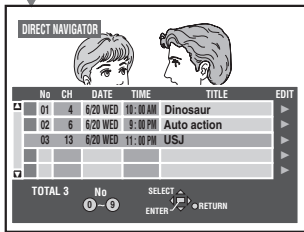

Press [▲, ▼] to select the program.

- You can also select programs by entering a 2-digit number with the numbered buttons. e.g., "5": [0] → [5]

Press [▶] so the submenu appears.

Press [▲, ▼] to select the item and press [ENTER].

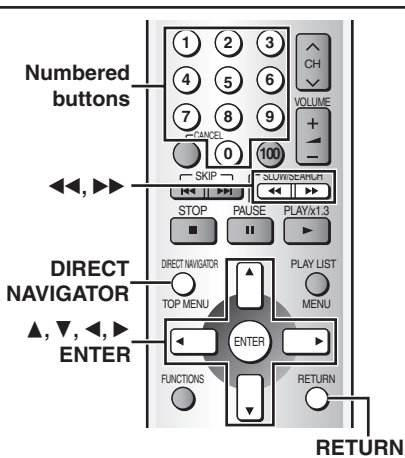

To clear the program list
Press [DIRECT NAVIGATOR].

To stop set up process
Press [RETURN].

For your reference

You can only perform operations for "Properties" if the disc is write-protected. Release protection (cartridge → page 10, disc → page 38) to access other items. **RAM**

Erase Program

RAM DVD-R

The program, and play lists created from it, are erased irretrievably when you use this procedure. Check carefully before proceeding.

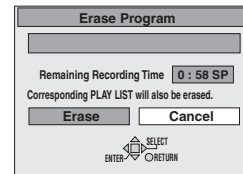

Enter Title

RAM DVD-R

Entering text → page 27

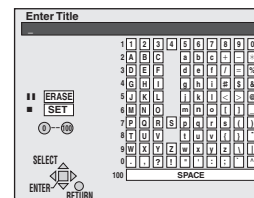

Properties

RAM DVD-R

Program information (e.g., time and date) is shown.

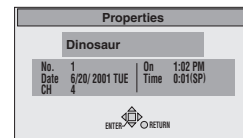

Protection

RAM

If set, this will protect the program from accidental erasure.

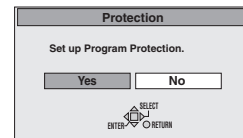

Shorten Segment

RAM

The program segment, and play list scenes created from it, are erased irretrievably when you use this procedure. Check carefully before proceeding.

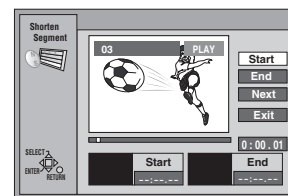

Divide Program

RAM

Select a point at which to divide the program into two.

You must be sure you wish to divide a program because once a program has been divided, it cannot be returned to its original form.

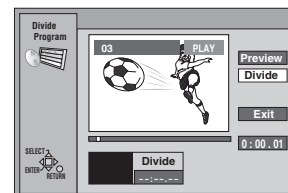

Press [◀] to select "Erase" and press [ENTER].
The program is erased.

Note

- The disc's available recording time may not increase after erasing short programs.
- Computer data cannot be erased.
- The available recording time on DVD-R does not increase when you erase programs.

Press [◀] to set protection and press [ENTER].

The lock symbol appears when the program is write-protected.

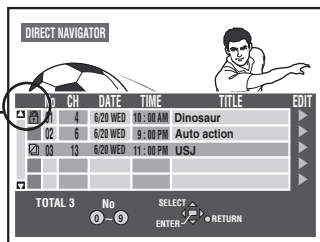

Press [ENTER] at the start point of the section you want to erase.

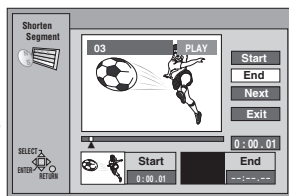

Press [ENTER] at the end point of the section you want to erase.

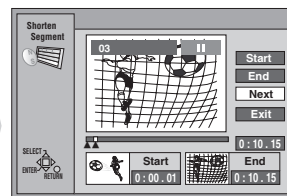

Press [▲, ▼] to select "Next" and press [ENTER], then press [◀] to select "Erase" and press [ENTER].

Press [▲, ▼] to select "Exit" and press [ENTER].

Repeat to enter other sections.

Note

- Use [◀◀], [▶▶] and slow-motion (→ page 20) to find the start and end points.
- Play pauses if the end of the program is reached during this procedure.
- You may not be able to specify points within 3 seconds of each other.
- You cannot specify an end point before a start point.
- You cannot specify points on still pictures in the program.
- The disc's available recording time may not increase after erasing short segments.

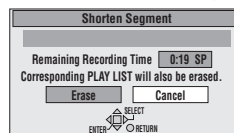

Press [◀] to select "Erase" and press [ENTER].

Press [ENTER] at the point you want to divide the program.

Press [▲, ▼] to select "Exit" and press [ENTER].

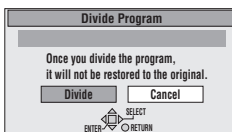

Press [◀] to select "Divide" and press [ENTER].
The program is divided.

To confirm the division point

Press [▲, ▼] to select "Preview" and press [ENTER]. (Play will begin from a point 10 seconds prior to and after the division point.)

To change the division point

Restart play and press [▲, ▼] to select "Divide", then press [ENTER] at the point you want to change.

Note

- The divided programs retain the title and CPRM property (→ page 53) of the original program.
- A very small portion of the recording preceding the division point may be lost.
- It is not possible to carry out Divide Program in the following cases:
 - when the program is extremely short.
 - when the total number of programs is more than 99.

Operation

While stopped
Press [FUNCTIONS].

Press [▲, ▼, ◀, ▶] to
select "JPEG" and press
[ENTER].

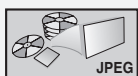

e.g., SD card: First page

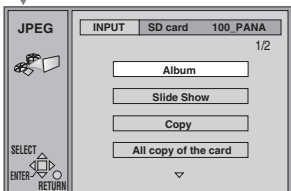

Press [▲, ▼] to select
the item and press
[ENTER].

To select a folder other than the
one currently being displayed,
first highlight "INPUT" and press
[ENTER].

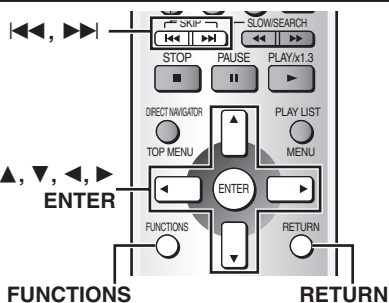

To insert/remove the SD/PC card

(→ page 18)

When the "SD" or "CARD" indicator in the unit display is flashing, the card is being read from or written to. Do not turn off the power or remove the card. Such action may result in malfunction or loss of the card's contents.

To stop set up process

Press [RETURN].

- You can also use [▲, ▼, ◀, ▶] to select "Cancel" or "No" and press [ENTER].

Note

You can only perform operations for "INPUT", "Album" and "Slide Show" if the card is set to Write Protect (SD/CARD → page 11) or Folder Protect (SD/CARD RAM → page 36) or if Disc Protection (RAM → page 38) or Cartridge Protection (RAM → page 10) is activated. Deactivate the protection to access other items.

INPUT

SD/CARD RAM

You can select the folder for editing.

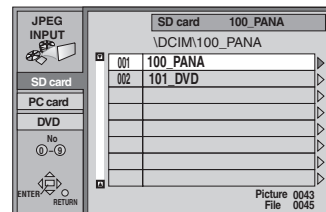

Album

→ page 18, Displaying still pictures (Album Display)

Slide Show

→ page 19, To display still pictures one by one with constant interval (Slide Show)

Copy

SD/CARD ↔ RAM

You can copy the whole folder or selected still pictures to memory card or DVD-RAM. (maximum of 300 folders, 3000 files)

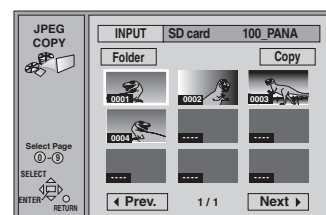

Note

- When there is no folder in the copying drive, a new folder will be created.
- When there is a folder in the copying drive, copying will continue from the last of the existing still pictures.
- When copying a folder, any files in the folder besides the still pictures are also copied.
- Folders lower than the folder to be copied will not be copied.
- If the space on the copying drive runs out or the number of files/folders to be copied exceeds the maximum, copying will stop partway through.
- If no title has been entered for the folder at the copying drive, the title from the copying source will be entered. It is recommended that the title is entered at the copying source.
- After copying, it may take some time to download the copying source information.
- Print (DPOF) number setting (→ page 36) is not transferred.

All copy of the card

SD/CARD → RAM

You can copy the whole contents of the memory card to DVD-RAM. (maximum of 300 folders, 3000 files)

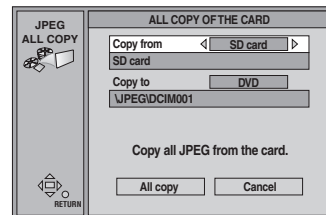

Note

- A new folder will be created in the copying drive.
- All compatible files in the folder are copied even if they are not still pictures.
- Folders lower than the folder to be copied will not be copied.
- If the space on the copying drive runs out or the number of files/folders to be copied exceeds the maximum, copying will stop partway through.
- After copying, it may take some time to download the copying source information.
- Print (DPOF) number setting (→ page 36) is not transferred.

Erase, Protect, Print (DPOF) → page 36

Settings → page 19, "To change the display timing" → page 36, "Format"

Press [**◀**] and [**▲, ▼**] to select the drive and press [**▶**].

Press [**▲, ▼**] to select still picture's folder and press [**ENTER**].

Note

- "Picture" and "File" refer to numbers inside the folder selected. Lower files are not included.
- If there is more than one upper folder, pressing [**◀◀**], [**▶▶**] will switch between them (→ page 11, Still picture folder structure).

To enter the folder's title

After selecting the still picture's folder, press [**▶**] to select "Folder Title" and press [**ENTER**].

(→page 27, Entering text)

- You can enter up to 36 characters.
- Folder titles entered using this unit will only be displayed using this unit. Folders entered using this unit are written to the TITLE.DVD file.
- If there is not enough space for the entry or if the limit for the number of files has been exceeded (→page 11, Still pictures), the title cannot be entered.

Press [**▲, ▼, ◀, ▶**] to select a folder or still picture and press [**ENTER**]. (See below)

A check mark appears on the still picture.



- Repeat this if you select more than one still picture.

Press [**▲, ▼, ◀, ▶**] to select "Copy" and press [**ENTER**].

A confirmation screen appears.

Select the copying drive.

(→ below)

Press [**▲, ▼, ◀, ▶**] to select "Copy" and press [**ENTER**].

Copying of still pictures begins.

To select still pictures one by one

Press [**▲, ▼, ◀, ▶**] to select a still picture and press [**ENTER**]. (A check mark appears on the still picture.)

To select all the still pictures in the folder

Press [**▲, ▼, ◀, ▶**] to select "Folder" and press [**ENTER**]. (A check mark appears on the folder's name; check marks inputted separately will be erased.)

To erase check marks

Press [**▲, ▼, ◀, ▶**] to select the folder or still picture with the check mark and press [**ENTER**].

To select the copying drive

While the confirmation screen is displayed

1. Press [**▲, ▼**] to select "Destination" and press [**ENTER**].
 2. Press [**◀**] and [**▲, ▼**] to select the drive.
 3. Press [**▶**] and [**▲, ▼**] to select the folder and press [**ENTER**].
- Some folders cannot be copied to [→ page 11, Still picture folder structure (indicated by ※)].

Press [**◀, ▶**] to select "SD card" or "PC card".

Press [**▲, ▼, ◀, ▶**] to select "All copy" and press [**ENTER**].

All still pictures are copied, and ALL COPY screen reappears.

Note

Still pictures are copied but non-compatible files and folders will not copied (→ page 11).

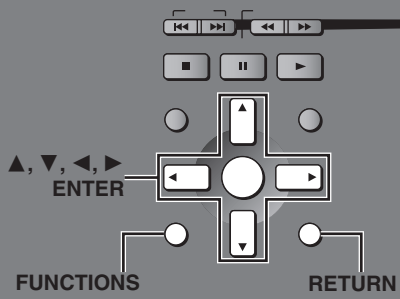

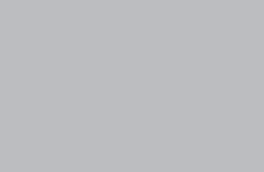
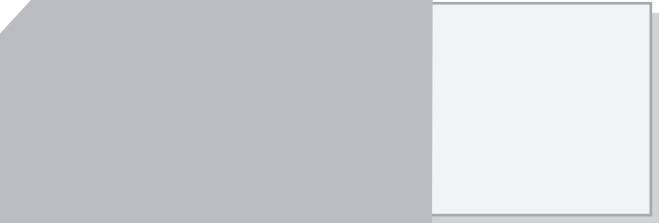
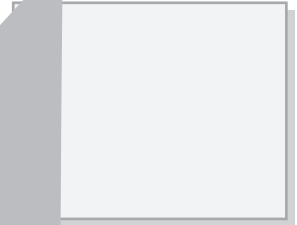
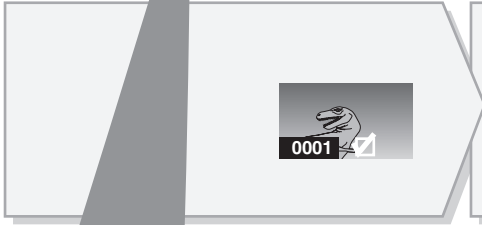

Operation

While stopped
Press [FUNCTIONS].

Press [▲, ▼, ◀, ▶] to
select "DISC SETTING"
and press [ENTER].



DISC SETTING

e.g., DVD-RAM

DISC SETTING Prog # 7 Free 0 : 42 (SP)
Used 0 : 58 Total Mark 10

Enter Title

Disc Protection Off

Erase all programs

Format

Press [▲, ▼] to select
the item and press
[ENTER].

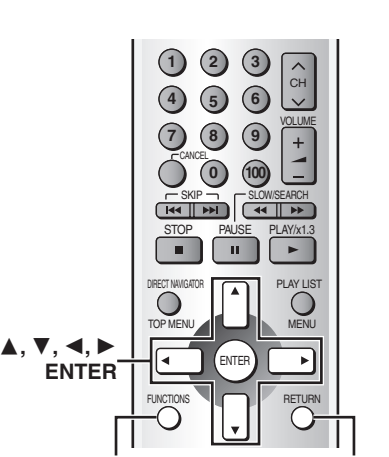

To stop set up process
Press [RETURN].

Enter Title

RAM DVD-R

Entering text → page 27

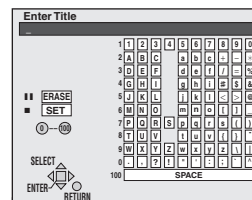

Disc Protection

RAM

If set, this will protect the disc from accidental erasure.

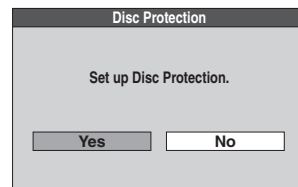

Erase all programs

RAM

All programs and play lists created from them will be erased irretrievably when you use this procedure. Check carefully before proceeding.

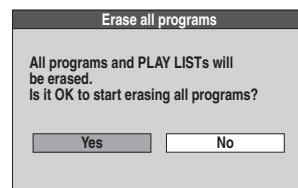

Preparation

Release protection (cartridge → page 10, program → page 32, disc → above) before proceeding.

Format

RAM

Some DVD-RAM are unformatted. Format them before using them in this unit. Formatting also allows you to erase the entire contents of a disc.

Formatting erases all contents on the disc, including computer data. Check carefully before proceeding.

Preparation

- Release protection (cartridge → page 10) before proceeding.
- If the disc is dirty, clean it with the recommended cleaner (→ page 53) before formatting.

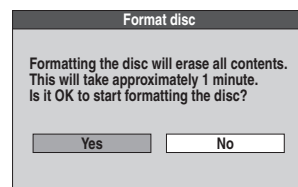

Finalize

DVD-R

(DVD-R recorded on this unit only)

You can play DVD-R on compatible DVD players by finalizing them on this unit, effectively making them into DVD-Video.

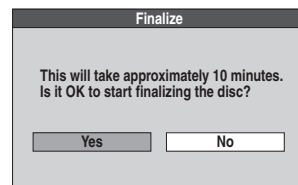

For your reference

The markers you entered (→ page 21) will be lost.

Press [◀] to set disc protection and press [ENTER].

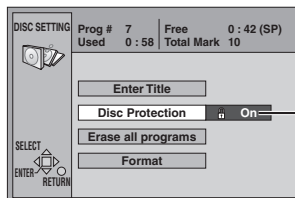

The lock symbol appears closed when the disc is write-protected.

Press [◀] to select "Yes" and press [ENTER].

Press [◀] to select "Start" and press [ENTER].

All programs and play lists are erased.

Note

- Computer data and still pictures (JPEG, TIFF) cannot be erased.
- Erase does not work if one or more programs are protected.

Press [◀] to select "Yes" and press [ENTER].

Press [◀] to select "Start" and press [ENTER].

Formatting starts.
• A message appears when formatting is finished.

Press [ENTER] to complete the procedure.

Note

- Do not disconnect the AC power supply cord while the message "Formatting the disc" is on the television. This can render the disc unusable.
- Formatting normally takes a few minutes, however it may take up to a maximum of 70 minutes.
- The contents on the disc are erased when you format it even if you have set program or disc protection.
- It may not be possible to use a disc on this unit if you cannot format it.
- Formatting cannot be performed on DVD-R or CD-R/RW.

To stop formatting

Press [RETURN].
You can cancel formatting if it takes more than 2 minutes. The disc must be reformatted if you do this.

Press [◀] to select "Yes" and press [ENTER].

Press [◀] to select "Start" and press [ENTER].

Finalizing starts.
• A message appears when finalizing is finished.

Press [ENTER] to complete the procedure.

Note

- Do not disconnect the AC power supply cord while the message "Finalizing the disc" is on the television. This will render the disc unusable.
- Finalizing takes up to 15 minutes.

After finalizing..

- You cannot record or perform editing such as giving titles and erasing programs.
- Programs longer than 5 minutes are divided into about five-minute chapters.
- These DVD-R can be played on other Panasonic DVD players, but this is not guaranteed. Play may not be possible due to the player you are using, the DVD-R, or the condition of the recording. Play the disc using this unit if you experience problems with other equipment. Visit Panasonic's homepage for more information about DVDs. <http://www.panasonic.com/broadcast>

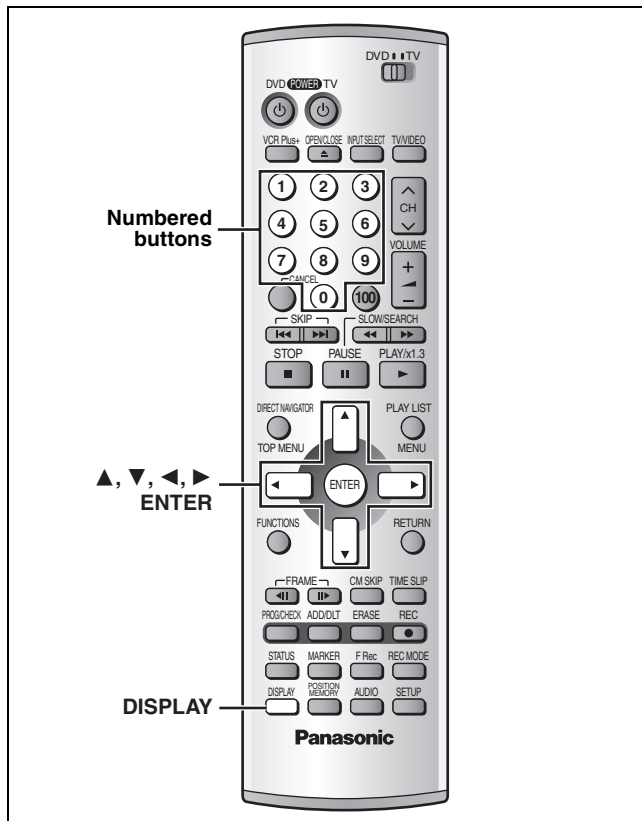

Common procedures

1 Press [DISPLAY].

e.g., DVD-RAM

Disc	Sound track	1	Digital 2/0 ch
Play	Subtitle	OFF	
Video	Audio channel	L R	

Menu Item Setting

2 Press [▲, ▼] to select the menu and press [▶].

3 Press [▲, ▼] to select the item and press [▶].

4 Press [▲, ▼] to select the setting.

To clear the on-screen menus

Press [DISPLAY].

For your reference

- Some items can be changed by pressing [ENTER].
- Some items can also be changed with the numbered buttons.
- The screens depend on the disc contents.
- Depending on the condition of the unit (playing, stopped, etc.) and disc contents, there are some items that you cannot select or change.

Disc menu

Not available when playing CDs and MP3 discs.

e.g., DVD-RAM

Disc	Sound track	1	Digital 2/0 ch
Play	Subtitle	OFF	
Video	Audio channel	L R	

Item	Content
Sound track	Soundtrack language DVD-A DVD-V See A below.
	Audio attribute RAM DVD-R DVD-A DVD-V See B below.
	Karaoke vocals, on and off (Karaoke DVD-V only) Solo: ON ↔ OFF Duet: OFF ↔ V1+V2 ↔ V1 ↔ V2
Subtitle	Subtitle language DVD-A DVD-V See A below.
	Subtitle on/off RAM DVD-R DVD-A DVD-V
Angle	Angle number DVD-A DVD-V
STILL-P	Page Still picture number DVD-A • When "Return" is displayed Select "Return" and press [ENTER] to return to the default page. • When "RANDOM" is displayed Select "RANDOM" and press [ENTER], the picture changes randomly each time you press [ENTER].
	Slide Show (Display only) DVD-A
Audio channel	RAM VCD (→page 19)
PBC	Playback control on/off VCD Indicates whether menu play (playback control) is on or off.

A Soundtrack/Subtitle language

ENG: English	SVE: Swedish	CHI: Chinese
FRA: French	NOR: Norwegian	KOR: Korean
DEU: German	DAN: Danish	MAL: Malay
ITA: Italian	POR: Portuguese	VIE: Vietnamese
ESP: Spanish	RUS: Russian	THA: Thai
NLD: Dutch	JPN: Japanese	*: Others

B Audio attributes

LPCM/PPCM/Digital/DTS/MPEG: Signal type

k (kHz): Sampling frequency

b (bit): Number of bits

ch (channel): Number of channels

e.g., 3/2_1ch

.1:	Low frequency effect (not displayed if there is no signal)
0:	No surround
1:	Mono surround
2:	Stereo surround (left/right)
1:	Center
2:	Front left+Front right
3:	Front left+Front right+Center

For your reference

- When playing back recordings of SAP broadcasts, "1+1 ch" will be displayed.
- You can only select subtitles, soundtracks, and angles if they are recorded on the disc.
- Some discs allow changes to soundtracks, subtitles, and angles only by using the disc's menus.
- If the subtitles overlap closed captions recorded on discs, turn the subtitles off.

Play menu

e.g., DVD-RAM

Disc	Repeat play	OFF
Play	Marker	1-10 *****
Video		
Audio		

Item	Content	Remarks
Repeat play	<p>Each time you press [▲, ▼]:</p> <p>RAM DVD-R DVD-V</p> <p>PRG: Program Chapter All Title PL: Play list (RAM) OFF OFF</p> <p>VCD CD DVD-A MP3</p> <p>Track Track All Group OFF OFF</p> <p>To cancel: Select "OFF".</p>	<ul style="list-style-type: none"> You cannot use repeat play to repeat an entire DVD-Audio, DVD-Video, MP3 discs or all the play lists on a DVD-RAM. Repeat play does not work if the disc's elapsed play time is not shown on the unit's display. [ERASE] does not work while in repeat play mode. <p>If the Video CD has playback control</p> <p>① While stopped (the screen saver is on the television), press the numbered buttons to select a track (→page 20).</p> <p>② Select the repeat mode.</p> 
Marker	<p>RAM DVD-R DVD-A DVD-V VCD CD MP3</p> <p>(→page 21)</p>	—

Audio menu

Not available when playing Video CDs, CDs and MP3 discs.

e.g., DVD-Video

Disc	V. S. S.	OFF
Play	Dialog Enhancer	OFF
Video		
Audio		

Item	Content	Remarks
V.S.S.	<p>RAM DVD-R DVD-V</p> <p>(Only with Dolby Digital with 2 or more channels) Enjoy a surround-like effect if you are using two front speakers only. The effect is broadened and sound seems to come from virtual speakers on either side if the disc has surround signals recorded on it. Natural ↔ Emphasis ↔ OFF ↑—————↓</p>	<ul style="list-style-type: none"> Turn off the surround effects on the other equipment. V.S.S. will not work, or will have less effect, with some discs. Turn V.S.S. off if it causes distortion. V.S.S. does not work for SAP recordings made on this unit's tuner.
Dialog Enhancer	<p>DVD-V</p> <p>(Dolby Digital, 3-channel or over only, including a center channel) The volume of the center channel is raised to make dialog easier to hear. ON ↔ OFF</p>	—

Video menu

Not available when playing CDs and MP3 discs.

Disc	Picture	Normal
Play	MPEG-DNR	ON
Video		
Audio		

Item	Content
Picture	<p>Normal: Default setting Soft: Soft picture with fewer video artifacts Fine: Details are sharper Cinema: Mellows movies, enhances detail in dark scenes. User: You can make further adjustments. See page 42.</p>
MPEG-DNR	<p>(When any item other than "User" is selected) You can turn the recommended settings for 3D NR, block NR, and mosquito NR (→page 42) on and off. ON ↔ OFF</p>

■ When you have set "TV Type" to "Aspect 4:3 & 480P" or "Aspect 16:9 & 480P" in SETUP (→page 9)

Disc	Picture	Normal
Play	MPEG-DNR	ON
Video	Progressive	ON
Audio	Transfer	Auto 1

Item	Content
Progressive	<p>ON: Enables progressive output OFF: Disables progressive output</p>
Transfer (When progressive output is on)	<p>Select the method of conversion for progressive output to suit the type of material being played (→page 53, Film and video). Auto1 (normal): For film material Auto2: For film material (the same as Auto1, but able to convert 30-frame-per-second progressive video.) Video: For video material</p>

Video menu

■ When “User” is selected

Select “Detail picture adjustment”.

(“User” → [◀] → [▼] → [ENTER])



Page 1/2 of “Detail picture adjustment”

Contrast	Increases the contrast between light and dark parts of the picture (–7 to +7).
Brightness	Brightens the picture (0 to +15).
Sharpness	Adjust the sharpness of the edges of the horizontal lines (–6 to +6).
Color	Adjusts the shade of the picture’s color (–7 to +7).

Press [ENTER] to enter the setting.

Press [▲] or [▼] until page 2/2 appears.

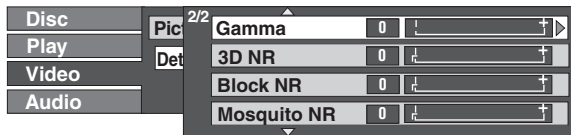

Page 2/2 of “Detail picture adjustment”

Gamma	Increases the brightness of the center ranges to improve detail and contrast in dark scenes (0 to +5).
3D NR	Reduces overall noise (0 to +4).
Block NR	Smooths block noise (0 to +3).
Mosquito NR	Reduces the smudging that appears around contrasting sections of the picture (0 to +3).

Press [ENTER] to enter the setting.

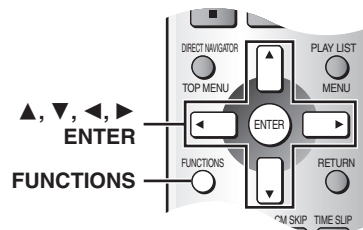

RAM DVD-R DVD-A DVD-V VCD CD MP3

By using the FUNCTIONS window you may access the main functions quickly and easily.

1 While stopped Press [FUNCTIONS].

e.g., DVD-RAM

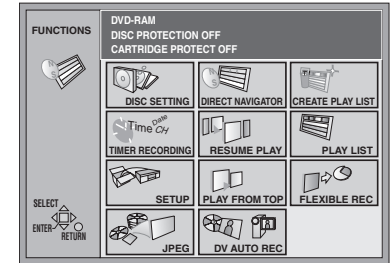

2 Press [▲, ▼, ◀, ▶] to select an item.

Refer to the relevant pages for details.

Icon	Refer to
DISC SETTING	→page 38, Disc setting
TIMER RECORDING	→page 24, Timer recording
SETUP	→page 44, Changing the unit’s settings
JPEGE	→page 18, Playing still pictures →page 34, Editing still pictures
DIRECT NAVIGATOR	→page 17, Using the Direct Navigator →page 32, Editing programs
RESUME PLAY	→page 16, Playing discs
PLAY FROM TOP	RAM DVD-R Play will begin with the oldest program on the disc (Program 1). DVD-A DVD-V Play will avoid playing the introductory parts and begin playing the contents immediately. (The performance of this function varies from disc to disc.)
DV AUTO REC	→page 15, DV Automatic Recording
CREATE PLAY LIST	→page 28, Creating play lists
PLAY LIST	→page 29, Playing play lists →page 30, Editing play lists
FLEXIBLE REC	→page 15, Recording the best quality pictures in the remaining time—Flexible Recording
TOP MENU MENU	→page 17, When a menu screen appears on the television

Functions displayed depend on the type of disc.

- Some items will be grayed out and cannot be selected if:
 - the disc is write protected/the disc is not formatted/there is nothing recorded on the disc.

3 Press [ENTER].

Your selection is entered and the FUNCTIONS window disappears. If the operation requires further selections, another screen appears.

To clear the FUNCTIONS window

Press [FUNCTIONS].

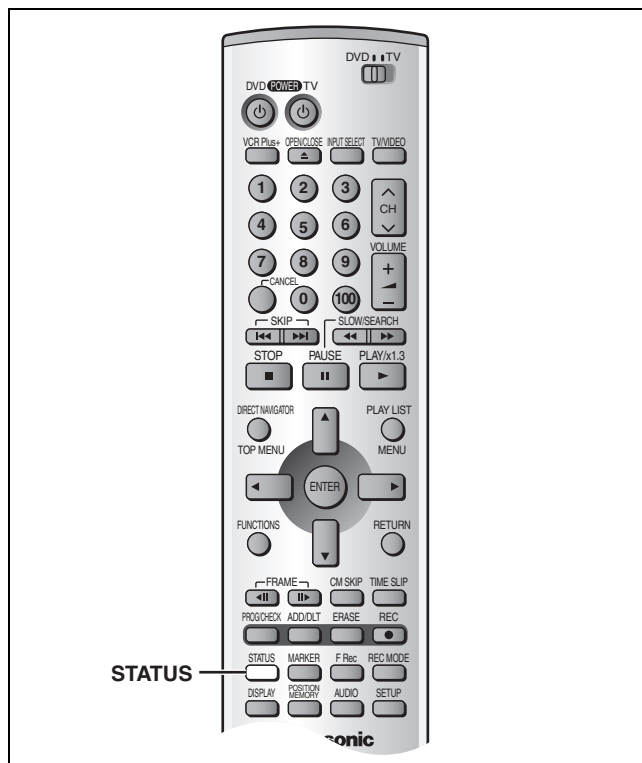

Displays appear on the television when you operate the unit to let you know what operation was performed and what condition the unit is in.

- You can change the setting in the SETUP menu so the first display does not appear automatically (→page 45, Display—Status Messages).

Changing the information displayed

Press [STATUS].

The display changes each time you press the button.
e.g., DVD-RAM

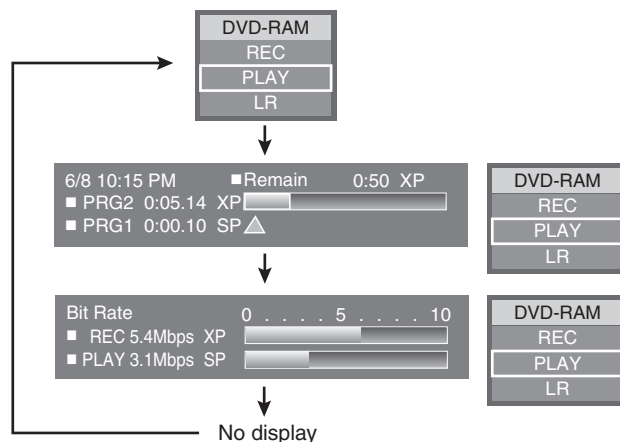

Display examples

e.g., DVD-RAM

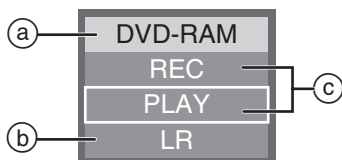

a) Disc indication

b) Audio type (→page 19)

Shows the selected audio type.

- During reception
 - Stereo:** Stereo is selected
 - Mono:** Monaural is selected
 - SAP:** Secondary audio program is selected

("(" appears when the type you have selected is actually being received.)

- During play

LR, R, L: a stereo program is recorded
MAIN, SAP: an SAP program is recorded

c) Current recording or play status/input channel and caption (if entered)

- REC:** Recording
- PAUSE:** Recording paused
- PLAY:** Playing
- ◀◀:** Rewinding
- ◀:** Reverse slow-motion
- ▶▶:** Fast forwarding
- ▶:** Slow-motion

e.g., DVD-RAM

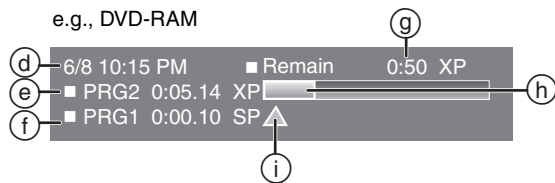

d) The current date and time

e) Elapsed recording time/recording mode

f) Elapsed play time of a program playing/mode at the time of recording

g) Available recording time and recording mode

h) Approximate volume of recording

i) Play position in the volume of recording

j) Selected group and track name

k) Selected group and track number

l) Selected track no./Total track no. in all groups

m) Elapsed play time of a track playing

e.g., MP3

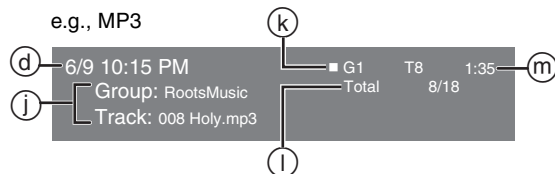

e.g., DVD-RAM

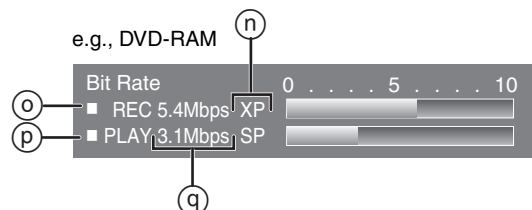

n) Recording mode or I/P/B display when paused (→page 53)

o) Video bit-rate when recording

p) Video bit-rate when playing

- q) Bit-rate display*** Show as Mbps (Megabits per seconds) during play and recording, or kbit (kilobits) while paused.

* The method of calculating bit-rate for recording and playing is different so there may be differences in the figures displayed. (Values are approximate.)

Summary of settings

This chart shows the initial settings for this unit. See page 46 for details on menu operation.

• Underlined items are the factory presets.

Tabs	Menus	Options
Channel	Antenna System (→page 7) Select to suit the type of antenna you are using. Channels are set corresponding to the antenna system you select.	•TV • <u>CATV</u>
	Auto Channel Setting (→page 7) The unit sets the channels automatically.	
	Preset Channel Caption (→page 47) You can give preset captions to the channels.	
	Manual Channel Caption (→page 47) You can set channel captions manually.	
	VCR Plus+ CH Setting (→page 8) Set the guide channels for use with VCR Plus+ timer recording.	
Set Up	Off Timer Select how long the unit remains on when it is not being used.	•2 hr • <u>6 hr</u> •Off
	Remote Control Code (→page 46) To avoid operating equipment other than the one intended (when more than one remote controlled item is in the same area), change the remote control code.	• <u>Set Code 1</u> •Set Code 2 •Set Code 3
	Auto Clock Setting (→page 7) The unit adjusts the clock automatically.	
	Manual Clock Setting (→page 7) You can adjust the clock.	
	Time Zone Adjust (→page 7) Adjust the time zone if it was not set correctly after auto clock setting. This appears only after auto clock setting is complete.	•-1 • <u>0</u> •+1
	Re-initialize Setting This returns all values in the SETUP menus, except for the clock, channel settings, ratings level, and display language, to the default settings.	•Yes • <u>No</u>
Disc	Audio Choose the audio language.	Some discs start in a certain language despite any changes you make here.
	Subtitle Choose the subtitle language.	
	Menus Choose the language for disc menus.	
	Ratings Set a ratings level to limit DVD-Video play. The password screen is shown when you select levels 0 to 7. To enter a password 1. Input a 4-digit password with the numbered buttons. •If you enter a wrong number, press [CANCEL] to erase it. • Do not forget your password. 2. Press [ENTER]. •The lock symbol appears closed to show the rating is locked. 3. Press [ENTER] to confirm the 4 digits.	<ul style="list-style-type: none"> •<u>English</u> •French •Spanish •Original: The original language of each disc will be selected. •Other ****: Input a code (→back cover).
		<ul style="list-style-type: none"> •<u>Automatic</u>: If the language selected for "Audio" is not available, subtitles of that language will automatically appear if available on that disc. •English •French •Spanish •Other ****
		<ul style="list-style-type: none"> •<u>English</u> •French •Spanish •Other ****
	<p>Setting ratings (When level 8 is selected) 8 No Limit: All DVD-Video can be played. 1 to 7: Prohibits play of DVD-Video with corresponding ratings recorded on them. 0 Lock All: Prohibits play of all DVD-Video.</p> <p>----- Changing ratings (When level 0-7 is selected) •Unlock Recorder •Change Password •Change Level •Temporary Unlock</p>	
	If you insert a DVD-Video that exceeds the ratings limit you set, a message appears on the television. Press [SETUP] to select "Ratings" again and change ratings.	
	DVD-Video mode Select how to play pictures contained on some DVD-Audio. The setting returns to "Off" when you change the disc or turn the unit off.	<ul style="list-style-type: none"> •On: You can play DVD-Video content on DVD-Audio. •<u>Off</u>: DVD-Audio are played as DVD-Audio.
Video	3-D Y/C Separation Turn 3-D Y/C separation on or off.	<ul style="list-style-type: none"> •<u>On</u>: Reduces noise for recording by separating the luminance (Y) and color (C) signals received from the television station. •Off: Reduces the ghosting that occurs when recording fast moving images.
	Hybrid VBR Resolution Switch between automatic and fixed hybrid VBR resolution when recording.	<ul style="list-style-type: none"> •<u>Automatic</u>: The unit automatically switches resolution rates during recording. The unit reduces block noise, which occurs during MPEG compression, by selecting the optimum rate. •Fixed: The resolution rate is fixed to ensure the resolution rate is not reduced.
	Still Mode Select the type of picture shown when you pause play.	<ul style="list-style-type: none"> •<u>Automatic</u> •Field: Less blurred field stills are shown. Select if jittering occurs when "Automatic" is selected. •Frame: Sharper frame stills are shown. Select if small text or fine patterns cannot be seen clearly when "Automatic" is selected.

Tabs	Menus	Options
Video	Seamless Play Turn seamless play on or off on discs with play lists. • Seamless Play does not work with programs recorded in LPCM or when using Quick View.	• On : The scenes in play lists are played seamlessly. This may cause shifting of the points where scenes change. Some play lists cannot be played seamlessly. • Off : The points where scenes in play lists change are played accurately, but the picture may freeze for a moment.
	Black Level Control Select normal, lighter or darker for adjusting the black level control to the desired setting for picture enhancement.	• Input Level (Lighter/Darker) : Adjusts the black level of the input signal (e.g., L1, L2, L3) • Composite & S Video Output Level (Lighter/Darker) : when connected to a TV through the VIDEO OUT or S-VIDEO OUT terminal • Component Video Output Level (Lighter/Normal/Darker) : when connected to a TV through the COMPONENT VIDEO OUT (Y/P _B /P _R) terminals
Audio	PLAY ×1.3 & Audio during Search RAM DVD-R DVD-A DVD-V VCD Choose whether to have sound during the first level of fast-forward. Quick View (→page 21) does not work if you make the setting "Off".	• On • Off – You may hear sound regardless of this setting with some discs. DVD-A
	D. Range Compression DVD-V (Dolby Digital only) Change the dynamic range for late night viewing.	• On • Off
	Select MTS (→page 19) Select whether to record the main or secondary audio type (SAP) when recording to DVD-R or when recording using LPCM sound ("Audio Mode for XP Recording" → below).	• Main • SAP – You cannot change secondary audio when recording audio to DVD-R from an external source.
	Digital Audio Output Change the settings when you have connected equipment through this unit's DIGITAL AUDIO OUT terminal (→page 50, A).	
	PCM Down Conversion You can select whether or not to convert recorded audio sampling rates from 96kHz or 88.2 kHz (as is if setting Off) to 48 kHz or 44.1 kHz (if the setting is On).	• On : If the equipment or connection doesn't support 96 kHz or 88.2 kHz. • Off : If the equipment or connection does support 96 kHz or 88.2 kHz. However, output will be down converted to 48 kHz or 44.1 kHz regardless of settings if the signal is greater than 176.4 kHz or a copy guard has been applied to the disc.
	Dolby Digital	• Bitstream : Select if the equipment you connected can decode the signal. • PCM : Select if the equipment you connected cannot decode the signal.
	DTS	• Bitstream : Select if the equipment you connected can decode the signal. • Off : Select if the equipment you connected cannot decode the signal.
Audio Mode for XP Recording Choose the audio type when recording with XP mode. • Sound recordings made using LPCM require more information than usual. Consequently the picture quality of LPCM recordings may be less than that of normal XP mode recordings.	• Dolby Digital (→page 53) • LPCM (→page 53)	
Select Audio CH for DV input (→page 46) You can select the kind of sound when recording from the unit's DV terminal.	• Stereo 1 • Stereo 2 • Mix	
Display	Status Messages Choose whether to show on-screen messages automatically.	• Automatic • Off
	Language of Display Message Choose the language for these menus and the on-screen messages.	• English • Español • Français
	Blue Background Select "Off" if you do not want to have the unit show the blue background when reception is weak.	• On • Off
	FL Display Changes the brightness of the unit's display.	• Bright • Dim • Automatic : The display dims during video playback and goes off completely when the unit is turned off or on timer recording standby. If you press a button the display will brighten briefly. (At this time the power consumed will be 0.36 W.)
TV Screen	TV Type (→page 9) Choose the setting to suit your television.	• Aspect 4:3 & 480i • Aspect 4:3 & 480P • Aspect 16:9 & 480i • Aspect 16:9 & 480P
	4:3 TV Settings for DVD-Video Select how DVD-Video widescreen picture is shown on a 4:3 standard aspect television.	• Pan & Scan (→page 53) : Video recorded for a widescreen is played as Pan & Scan (unless prohibited by the producer of the disc). • Letterbox (→page 53) : Video recorded for a widescreen is played in the letterbox style.
	4:3 TV Settings for DVD-RAM Select how DVD-RAM widescreen picture is shown on a 4:3 standard aspect television.	• 4:3 : Programs played as recorded. • Pan & Scan : Video recorded for a widescreen is played as Pan & Scan. • Letterbox : Video recorded for a widescreen is played in the letterbox style.

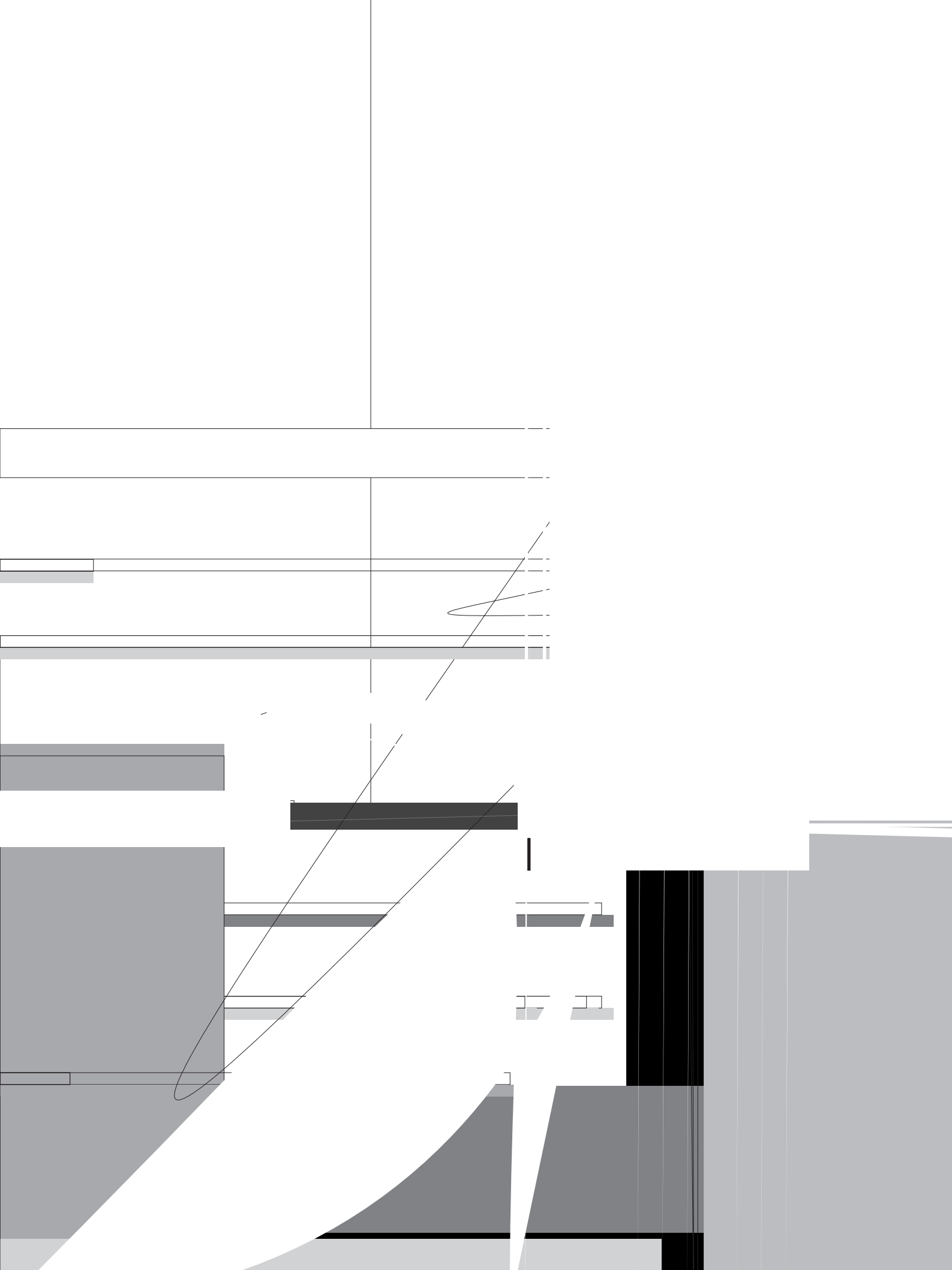



4 Press [▲, ▼] to select the caption and then press [▶].

You can choose from the following captions.

ABC, PBS, CBS, CNN, FOX, ESPN, NBC, HBO, A&E, AMC, FAM, MAX, MTV, SHOW, TBS, USA, TNT, CBC, UPN, CTV, WB, TSN, DSC, GLOB

- The screen scrolls a page at a time if you press and hold [▲, ▼].

5 Press [▲, ▼] to select the channel corresponding to the caption and then press [◀].

- Channels are not displayed if they do not contain a station or if captions have been added manually.
- To delete the channel number, press [CANCEL].
- Repeat steps 4 and 5 as necessary.

6 Press [ENTER].

The "Channel" screen reappears.

3 Press [▲, ▼] to select "Manual Channel Caption" and press [ENTER].

Repeat steps 4, 5, and 6 as

7 Press [ENTER].

The "Channel" screen reappears.

screen

When you are finished
Press [SETUP].

.5	
.o	
.gs on	—

SETUP—Audio— Digital Audio Output • Set PCM Down Conversion to Off.	45
--	----

SETUP—Audio— Digital Audio Output • Set PCM Down Conversion to suit the equipment. • Set Dolby Digital to PCM. • Set DTS to Off.	45
---	----

→page 50)

- The equipment connections described are examples.
- Peripheral equipment and optional cables sold separately unless otherwise indicated.
- Before connection, turn off all equipment and read the appropriate operating instructions.
- The signal from the cable TV box or satellite receiver passes through this unit to the television even when this unit is turned off.

Connecting a cable TV box/satellite receiver

You need to subscribe to a cable TV or satellite TV service, to enjoy viewing their programming.

- Consult your service provider regarding appropriate cable box or satellite receiver.
- Select the applicable input on your television to view the output from your cable box/satellite receiver through this unit.

One cable TV box/satellite receiver

You can record and view both scrambled and unscrambled channels if connections are made as shown in the diagram below.



Note

When a home satellite system (Dishnetwork/DSS) is connected, auto tuning and auto clock setting may not operate properly. Set the clock manually (→page 7).

- Change the video input on the television when you want to watch another program while recording.
- You cannot do a timer recording unless the channel is first selected on the cable TV box or DSS receiver.

- Change the video input on the television when you want to watch another program while recording.
- You cannot do a timer recording unless the channel is first selected on the cable TV box.

This model can play Dolby Digital, but only in two channels. This model does not have a DTS decoder. You must connect a unit with a Dolby Digital or DTS decoder to enjoy surround sound.

Recording to digital recording equipment or cassette tapes

Digital recording

You can record the digital signal directly to digital recording equipment (

Con

t

Con
the

s on

Advanced operation

...ad... low video cable you
...er picture

w vide

...t on the other equipment is mon... a stereo-
conversion cable (not included).

...er equipment is
...right chan...
... (O.)
...is for use with
...connecte...
...equipment.
...V equip... (recorder)
...to the u...
...press...
...diff...
...hi...
...ossible.

Other antenna connection to the unit

Use one of the following connections to suit the antenna lead.

■ A single twin lead

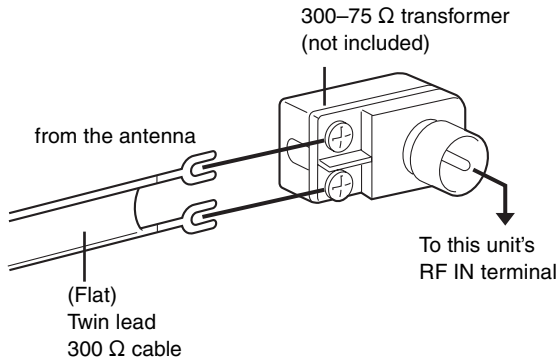

■ A twin lead and a coaxial cable

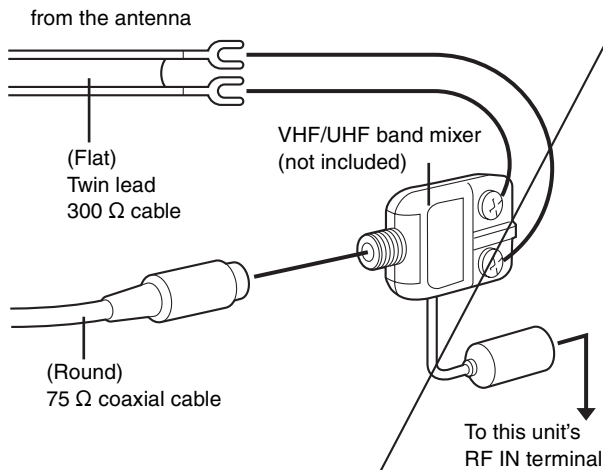

■ Two twin leads

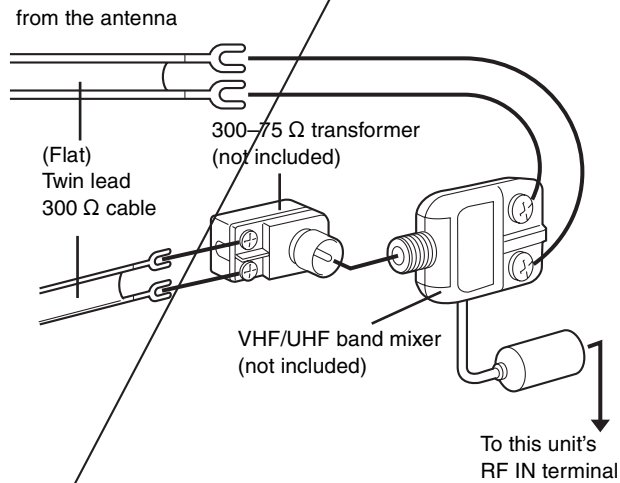

- If your television has both lead and coaxial VHF terminals, use the lead connection to minimize signal loss.

Other antenna connection from the unit to the television

Use one of the following connections to suit the antenna terminals on your television. Refer to the television's operating instructions.

■ A twin lead and coaxial plug terminal

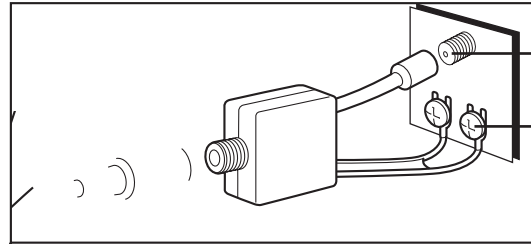

■ A twin lead terminal

■ Two twin lead terminals

■ Multiple antenna terminals

- Connect to one of the terminals, then change the television's setting as necessary.

Bitstream

This is the digital form of multi-channel audio data (e.g., 5.1 channel) before it is decoded into its various channels.

CPRM (Content Protection for Recordable Media)

CPRM is the copyright protection technology that is used to protect broadcasts that are allowed to be recorded only once (e.g. some CATV broadcasts).

Decoder

A decoder restores the coded audio signals on DVDs to normal. This is called decoding.

Dolby Digital

This is a method of coding digital signals developed by Dolby Laboratories. Apart from stereo (2-channel) audio, these signals can also be multi-channel audio. A large amount of audio information can be recorded on one disc using this method.

This unit is set to record using Dolby Digital in all recording modes.

Dolby Pro Logic

A surround system where a 4-channel audio track is recorded as 2 channels and then is restored to 4 channels for play. The surround channel is monaural and can reproduce up to 7 kHz.

DPOF (Digital Print Order Format)

DPOF is the standard printing format for still picture data. It is used by photo developing stores to print out the still picture data taken from a digital camera and other equipment or when printing from your home printer.

DTS (Digital Theater Systems)

This surround system is used in many movie theaters around the world. There is good separation between the channels, so realistic sound effects are possible.

Interlace and progressive output

NTSC, the video signal standard, has 480 interlaced (I) scan lines, whereas progressive scanning uses twice the number of scan lines. This is called 480P. The video signals output from this unit's COMPONENT VIDEO OUT terminals (Y, P_B, P_R) allow you to enjoy higher quality pictures than if the signals were output from the VIDEO OUT terminal or S-VIDEO OUT terminal.

I/P/B

MPEG 2, the video compression standard adopted for use with DVD-Video, codes frames using these 3 picture types.

I: Intra coded picture

This picture has the best quality and is the best to use when adjusting the picture.

P: Predictive coded picture

This picture is calculated based on past I- or P-pictures.

B: Bidirectionally-predictive coded picture

This picture is calculated by comparing past and future I- and P-pictures so it has the lowest volume of information.

JPEG (Joint Photographic Experts Group)

This is a system used for compressing/decoding color still pictures. If you select JPEG as the storage system on digital cameras etc., the data will be compressed to 1/10–1/100 of its original size. The special quality of this standard is that there is little deterioration in picture quality in comparison to the degree of compression.

Linear PCM (pulse code modulation)

These are uncompressed digital signals. This unit outputs linear PCM sound in 2 channels from the DIGITAL AUDIO OUT terminal. LPCM sound is available when recording in XP mode.

Playback control (PBC)

If a Video CD has playback control, you can select scenes and infor-

■ How to hold a disc

Do not touch the recorded surface.

■ If there is dirt or condensation on the disc

Moisture may condense on discs after they are brought inside from the cold.

DVD-RAM and DVD-R

Clean with an optional DVD-RAM/PD disc cleaner (LF-K200DCA1, where available).

Do not use cleaners or cloths for CDs to clean DVD-RAM and DVD-R.

DVD-Audio, DVD-Video, Video CD, CD

Wipe with a damp cloth and then wipe dry.

■ Handling precautions

- Do not attach labels or stickers to discs (This may cause disc warping, rendering it unusable).
- Do not write on the label side with a ball-point pen or other writing instrument.
- Do not use record cleaning sprays, benzine, thinner, static electricity prevention liquids or any other solvent.
- Do not use scratch-proof protectors or covers.
- Do not use the following discs:
 - Discs with exposed adhesive from removed stickers or labels (rented discs etc).
 - Discs that are badly warped or cracked.
 - Irregularly shaped discs, such as heart shapes.

On the television

Page

No disc.	● You haven't inserted a disc. Correctly insert a disc that this unit can use.	10
	● The disc is upside down. If it is a single-sided disc, insert it so the label is facing up.	14
This is non-recordable disc.	● The unit cannot record on the disc you inserted. Insert a DVD-RAM or unfinalized DVD-R.	10
This disc is not formatted properly. Please format the disc in 'DISC SETTING' to record.	● You inserted an unformatted DVD-RAM. Format the disc with this unit.	38
Cannot write into this card.	● You cannot format a microdrive or mobile hard disk on this unit.	—
This disc cannot be read.	● You inserted an incompatible disc.	10
Please check write protect tab on the disc.	<ul style="list-style-type: none"> ● The write-protect tab on the cartridge is set to PROTECT. Use a ballpoint pen or similar to release the write protection. 	—
Contents of this disc are protected.	● The program is write-protected. Cancel the protection.	32
	● The disc is write-protected. Cancel Disc Protection.	38
Cannot finish recording completely.	● The program was copy-guarded.	—
	● No space left on the disc.	32
	→ Create space by erasing any unwanted programs. RAM	—
	→ Use a new disc. RAM DVD-R	—
Cannot record on the disc.	● The disc is scratched. Use another disc.	—
	● The disc is dirty.	53
	● You inserted an incompatible disc.	10
Disc is full.	● No space left on the disc.	32
	→ Create space by erasing any unwanted programs. RAM	—
	→ Use a new disc. RAM DVD-R	—
Please set clock.	● The clock is not set.	7
This disc may not be played in your region.	● You tried to play a disc with a region number different from this unit's region number. This unit can only play discs with the region numbers compatible with this unit (1, All, or including the number 1).	Cover page
Your selection exceeds the recorder's rating limit.	● A ratings level has been set for DVD-Video with this unit. Unlock the unit with "Ratings" in "Disc".	44
Finalizing is necessary for compatible playback.	● To enable playback of your DVD-R on compatible equipment, it is necessary to finalize it.	38
No PC card. No valid PC card. No SD card. No valid SD card.	● The card is not inserted. If this message is displayed with a compatible card already inserted, turn off the power, remove and then re-insert the card.	18
	● The card format does not match.	11
	● The card inserted is not compatible.	11
Please check write protect tab.	● Release the protection on the card.	11
	● Release the protection on the DVD-RAM.	10
No folder	● There is no compatible folder in this unit.	11
Cannot write.	● The card is currently protected → Release the write protection.	11
	● There is no space remaining. → Erase any unwanted files (still pictures).	36
Error has occurred. Please press [ENTER].	● A serious, but temporary error has occurred and one of the unit's safety devices has activated. Press [ENTER]. The unit switches to the standby mode. Press [⏻, DVD POWER] to turn the unit on again.	—

On the unit's display

NO READ	● The disc is dirty or badly scratched.	53
	→ Clean the disc if it is dirty.	—
	→ The disc cannot be played if it is scratched and this display doesn't disappear.	—
	● The unit cannot read the disc.	57
UNSUPPORT	● You have inserted a disc the unit cannot play or record on.	10
	● You have used a DVD-RAM/PD lens cleaner and it has finished.	—
U14	● The unit is hot.	—
	→ The unit switches to standby automatically for safety reasons and you cannot operate it. Wait for about 30 minutes for the service number to disappear.	—
	→ Select a position with good ventilation when installing the unit.	—
	→ Do not block the cooling fan on the rear of the unit.	—
U99	● The unit fails to operate properly. Press [⏻, DVD POWER] to switch the unit to standby. Now press [⏻, DVD POWER] again to turn the unit on.	—
CHK REMOTE	● The remote control and main unit are using different codes. Change the code on the remote control.	46
RECOVER	● There was a power failure or the AC plug was disconnected while the power was on. The unit is carrying out its recovery process. Wait until the message disappears.	—

Troubleshooting guide

Before requesting service, make the below checks. If you are in doubt about some of the check points, or if the remedies indicated in the chart do not solve the problem:

In the U.S.A., go to <http://www.panasonic.com/broadcast>.

In Canada, contact the Panasonic Canada Inc. Customer Care Centre at 1-800-561-5505, or visit the website (www.panasonic.ca), or an authorized Servicentre closest to you.

Power

Page

No power.	<ul style="list-style-type: none"> ● Insert the AC power supply cord securely into a known active AC outlet. 	5
The unit switches to the standby mode.	<ul style="list-style-type: none"> ● This is a power saving feature. You can turn it off if you would prefer (Set Up—Off Timer—Off). Press [⏻, DVD POWER] to turn the unit on. ● One of the unit's safety devices may have activated. Press [⏻, DVD POWER] to turn the unit on. 	44 —

Operation

The unit is on but cannot be operated.	<ul style="list-style-type: none"> ● Some operations may be prohibited by the disc. ● The unit is hot ("U14" appears on the display). Wait for "U14" to disappear. ● One of the unit's safety devices may have activated. <p>Reset the unit as follows:</p> <ol style="list-style-type: none"> 1. Press [⏻, DVD POWER] to switch the unit to standby. If the unit doesn't switch to standby, press and hold [⏻, DVD POWER] for about 10 seconds. The unit is forcibly switched to standby. Alternatively, disconnect the AC power supply cord, wait one minute, then reconnect it. 2. Press [⏻, DVD POWER] to turn the unit on. 	— 54 —
---	--	---------------------

Picture

● When progressive output is on, refer also to "**Progressive video**" below.

The images from this unit do not appear on the television.	<ul style="list-style-type: none"> ● Make sure that the television is connected to the AUDIO/VIDEO terminals, S-VIDEO OUT terminal or COMPONENT VIDEO OUT terminals on this unit. ● Make sure that the television's input setting (e.g., VIDEO 1) is correct. ● You have set "TV Type" to "Aspect 4:3 & 480P" or "Aspect 16:9 & 480P" in the TV Screen menu, but the television isn't compatible with progressive signals. Press and hold [■] and [TIME SLIP] on the unit at the same time for about 5 seconds. The setting will change to interlace. 	5 — —
Television reception worsens after connecting the unit.	<ul style="list-style-type: none"> ● This can occur because the signals are being divided between the unit and the television. It can be solved by using a signal booster, available from audio-visual suppliers. Consult your dealer if reception does not improve. 	—
Screen size is wrong.	<ul style="list-style-type: none"> ● Check the settings on your television. ● Check the settings for "TV Type", "4:3 TV Settings for DVD-Video" or "4:3 TV Settings for DVD-RAM" in the TV Screen menu. 	— 9, 45
On-screen messages do not appear.	<ul style="list-style-type: none"> ● Go to the Display menu and select "Automatic" for "Status Messages". ● Press [STATUS] to show the on-screen messages constantly. 	45 43
The blue background does not appear.	<ul style="list-style-type: none"> ● Go to the Display menu and select "On" for "Blue Background". 	45
There is ghosting.	<ul style="list-style-type: none"> ● Change the settings for "3D NR", "Block NR", and "Mosquito NR" to "0" or turn "MPEG-DNR" off if it is on. 	41, 42
Play stops for a moment during Quick View.	<ul style="list-style-type: none"> ● Play may stop where two play lists join, but this is not a malfunction. 	—

Progressive video

There is ghosting when progressive output is on.	<ul style="list-style-type: none"> ● Set "Progressive" to "OFF". This problem is caused by the editing method or material used on DVD-Video, but should be corrected if you use interlace output. 	41
There is no apparent change in picture quality when adjusted with the Video menu in the on-screen menus.	<ul style="list-style-type: none"> ● The effect is less perceivable with some types of video. 	—

Sound

Page

No sound. Low volume. Distorted sound.	<ul style="list-style-type: none"> ● Check the connections. Check the input mode on the amplifier if you have connected one. ● Turn V.S.S. off if it causes distortion. 	<p>5, 49–51 41</p>
Cannot hear the desired audio type.	<ul style="list-style-type: none"> ● Press [AUDIO] to select the desired audio type. ● If “D.MIX” does not appear in the display when playing multi-channel DVD-Audio, audio output will be the front two speakers only. ● You cannot change the DVD-Audio audio type if the software producer has restricted play in stereo. 	<p>19 13 —</p>
Cannot switch audio during stereo or SAP broadcasts.	<ul style="list-style-type: none"> ● You have used digital connection. Set “Dolby Digital” to “PCM” or connect to other equipment using audio cables (analog connection). ● You cannot change the audio type when a DVD-R is in the disc tray. ● It is not possible to switch the audio when the recording mode is XP and “LPCM” has been selected in the SETUP menu, “Audio Mode for XP Recording”. → Select “Main” or “SAP” from “Select MTS” in the Audio menu before recording. 	<p>45, 50 — 45</p>

Play

Play fails to start even when [▶] (PLAY) is pressed. Play starts but then stops immediately.	<ul style="list-style-type: none"> ● Insert the disc correctly with the label facing up. ● This unit cannot play discs other than DVD-RAM, DVD-R, DVD-Audio, DVD-Video, Video CD, CD and MP3 discs. ● The disc is dirty. Clean it. ● The disc may be badly scratched. ● You inserted a blank DVD-RAM or DVD-R. ● Condensation has formed: Wait 1 to 2 hours for it to evaporate. 	<p>14 10 53 — — —</p>
A title or chapter doesn't play when it is selected.	<ul style="list-style-type: none"> ● Some titles and chapters on DVD-Video are not played when you have changed the ratings level. 	44
Picture distorted during search.	<ul style="list-style-type: none"> ● Some distortion is normal. 	—
Alternative soundtrack and subtitles cannot be selected.	<ul style="list-style-type: none"> ● The languages are not recorded on the disc. ● You may have to use the disc's menus to select languages. 	<p>— 17</p>
No subtitles.	<ul style="list-style-type: none"> ● Subtitles are not recorded on the disc. ● Turn the subtitles on. 	<p>— 40</p>
Angle cannot be changed.	<ul style="list-style-type: none"> ● This function depends on software availability. Angles can only be changed during scenes where different angles are recorded. 	—
You have forgotten your ratings password.	<ul style="list-style-type: none"> ● Return the ratings setting to “8”. While the disc tray is open, press and hold [◀◀◀/◀◀] and [▶▶/▶▶▶] on the main unit at the same time for 5 or more seconds. 	—

Displays

The display is dim.	<ul style="list-style-type: none"> ● Go to the Display menu and change the display's brightness with “FL Display”. 	45
“12:00” is flashing on the unit's display.	<ul style="list-style-type: none"> ● The clock is not set. 	7
The displayed recording time and actual recording time differ.	<ul style="list-style-type: none"> ● Displayed recording time is based on the number of frames per second. This number is subject to minute variations. When recording over long periods, these variations may result in the difference between displayed recording time and actual recording time. This is normal. 	—
The display doesn't show the correct time. [MP3]	<ul style="list-style-type: none"> ● Times may not appear correctly when searching through tracks recorded with a variable bit rate. 	—

Remote control

The remote control doesn't work.	<ul style="list-style-type: none"> ● [DVD, TV] is not switched to “DVD”. Switch to “DVD” when operating this unit. ● The remote control and main unit are using different codes. Change the code on the remote control. ● The batteries are depleted. Replace them with new ones. ● Point the remote control at the remote control sensor on the main unit. ● Remove obstacles from between the remote control and main unit. 	<p>12 46 6 6 —</p>
Cannot operate the television.	<ul style="list-style-type: none"> ● Change manufacturer code. Some televisions cannot be operated even if you change the code. ● [DVD, TV] is not switched to “TV”. Switch to “TV” when selecting the receiving channel for the television. 	<p>9 12</p>

Cannot record.	• You haven't inserted a disc or the disc you inserted cannot be recorded on. Insert a disc the unit can record onto.	10
	• The disc is unformatted. Format the disc so this unit can record on it. RAM	38
	• The write-protect tab on the cartridge is set to PROTECT.	10
	• Some programs have limitations on the number of times they can be recorded (CPRM).	14
	• The disc is protected with DISC SETTING.	38
	• The disc is full or nearly full. Erase unneeded programs or use another disc.	32
• You cannot record on finalized DVD-R discs.	—	
VCR Plus+ programming does not work properly.	• The guide channels are incorrect. Go to the Channel menu and correct them with "VCR Plus+ CH Setting".	8
	• The clock is wrong. Go to the Set Up menu and correct it with Clock settings.	7
Timer recording does not work properly.	• The timer program is incorrect. Correct the program.	26
	• The unit is not on timer recording standby. ("⏻" on the unit's display is not on.) Press [⏻, DVD POWER] to turn the unit off and make sure that "⏻" is on.	—
	• Different timer program times overlap.	—
	• The clock is wrong. Go to the Set Up menu and correct it with Clock settings.	7
The unit switches to standby while making a timer recording.	• The disc has run out of space. Use a disc that has enough space to record the program.	—
The timer program remains even after recording finishes.	• The timer program remains if set to daily or weekly.	25
Timer recording does not stop even when [■] is pressed.	• Press [■] and then [ENTER] within 5 seconds to turn "⏻" off. Recording stops.	—
The available recording time doesn't increase even after erasing recordings on the disc.	• As this unit is unable to erase data written to DVD-RAM with a computer, the available recording time does not increase. The data will be erased if you reformat the disc.	38
	• If the disc is dirty, wipe with the DVD-RAM/PD disc cleaner (optional) before formatting.	53
	• Available recording space on the DVD-R does not increase even after erasing previously recorded programming.	—
A part or whole of a recorded program has been lost.	• If there is a power failure or the plug is disconnected from the household AC outlet while recording or editing, the program may be lost or the disc may become unusable. → We cannot offer any guarantee regarding lost programs or discs. You will have to format the disc or use a new disc.	—

Still pictures

The contents of the card cannot be read.	• The memory card format is not compatible with the unit. → Format using FAT 12 or FAT 16 with other equipment or format the memory card with this unit.	36
	• The unit tried to display still picture files that were in a folder level that is not compatible.	11
	• The still picture file is not JPEG or TIFF. → This unit displays still pictures (JPEG and TIFF) that are in accordance with DCF standard.	11
	• Turn off and then turn on the unit again.	—
	• When there are a lot of folders and files, it may sometimes take a few hours.	—
Copying, erasing and setting protection takes a long time.	• When repeating copying or erasing, it may sometimes take a long time. Format the disc or memory card.	36, 38
The tray won't open/close.	• The tray cannot be opened or closed while the still pictures are played back and editing screen is being displayed. Press [RETURN] a few times to clear the screen.	—
The PC card cannot be removed.	• Make sure the PC card is slotted home firmly before attempting to remove.	18

Discs make sounds as they rotate. This does not indicate a malfunction.

Maintenance

The precision parts in this unit are readily affected by the environment, especially temperature, humidity, and dust. Cigarette smoke also can cause malfunction or breakdown.

To clean this unit, wipe with a soft, dry cloth.

- Never use alcohol, paint thinner or benzine to clean this unit.
- Before using chemically treated cloth, read the instructions that came with the cloth carefully.

Observe the following points to ensure continued listening and viewing pleasure.

Dust and dirt may adhere to the unit's lens over time, making it impossible to record or play discs.

Use the **DVD-RAM/PD lens cleaner (LF-K123LCA1)** about once every year, depending on frequency of use and the operating environment. Read the lens cleaner's instructions carefully before use.

Specifications

Recording system:	DVD video recording standards (DVD-RAM), DVD video standards (DVD-R)
Optical pick-up:	System with 1 lens, 2 integration units (662 nm wavelength for DVDs, 790 nm wavelength for CDs)
Recordable discs:	12 cm (5") 4.7 GB DVD-RAM discs 12 cm (5") 9.4 GB DVD-RAM discs 8 cm (3") 2.8 GB DVD-RAM discs 12 cm (5") 4.7 GB DVD-R discs 8 cm (3") 1.4 GB DVD-R discs (for General Ver. 2.0)
Recording time:	Max. 6 hours (using 4.7 GB disc) XP: 60 minutes SP: 120 minutes LP: 240 minutes EP: 360 minutes
Discs played:	12 cm (5") 4.7 GB DVD-RAM discs 12 cm (5") 9.4 GB DVD-RAM discs 8 cm (3") 2.8 GB DVD-RAM discs 12 cm (5") 4.7 GB DVD-R discs 8 cm (3") 1.4 GB DVD-R discs (for General Ver. 2.0) DVD-VIDEO discs CD-Audio discs (CD-DA) Video CD discs DVD-Audio discs CD-R/CD-RW discs (CD-DA, Video CD, MP3 formatted discs)
SD card slot:	SD Memory Card Slot
Compatible media:	SD Memory Card, Multi Media Card
PC card slot:	PC Card Type II
Compatible media:	A PC Card adaptor conforming to PC Card Standards, ATA Flash PC card, PC Card adaptor (SD Memory Card, Multi Media Card, Compact Flash, Smart Media, Memory Stick, xD picture card, Microdrive), Mobile hard disk
Format:	FAT12 or FAT16
Image format:	JPEG conforming to DCF (Design rule for Camera File system) TIFF (Uncompressed RGB chunky) DPOF Compatible
Number of pixels:	320 × 240 to 6144 × 4096 Sub sampling; 4:2:2 or 4:2:0
Thawing time:	Approx. 7 sec. (2 M pixels, JPEG)
Video system	
TV system:	NTSC system, 525 lines, 60 fields
Recording system:	MPEG2 (Hybrid VBR)
Input:	LINE (pin jack) × 3, 1.0 Vp-p; 75 Ω S connector × 3 Y: 1.0 Vp-p; 75 Ω C: 0.286 Vp-p; 75 Ω

Output:	LINE (BNC)	1.0 Vp-p; 75 Ω
	LINE (pin jack)	1.0 Vp-p; 75 Ω
	S connector × 2	Y: 1.0 Vp-p; 75 Ω C: 0.286 Vp-p; 75 Ω

Component video output (480P/480i):

Y:	1.0 Vp-p; 75 Ω
P _B :	0.7 Vp-p; 75 Ω
P _R :	0.7 Vp-p; 75 Ω

Antenna reception input:

TV Channel:	2ch–69ch, 75 Ω
CATV Channel:	1ch–125ch, 75 Ω

Audio system

Recording system: Dolby Digital (XP/SP/LP/EP)
LINEAR PCM (XP mode only)

Input: LINE (pin jack) × 3
Reference input: 309 mVrms
FS: 2 Vrms (1 kHz, 0 dB)
Input impedance: 47 kΩ

Output: LINE (pin jack) × 2
Reference output: 309 mVrms
FS: 2 Vrms (1 kHz, 0 dB)
Output impedance: 1 kΩ
(Load impedance: 10 kΩ)

Number of channels: Recording: 2 channels
Playback: 2 channels

Other input/output connectors:

Digital audio optical output connector
(PCM, Dolby Digital, DTS)

Operating temperature range:

5 °C–40 °C (41 °F–104 °F)

Operating humidity range:

10 %–80 % RH (no condensation)

Clock unit:

Quartz-controlled 12-hour digital display

LASER Specification

Class I LASER Product

Wave length: 775–815 nm 655–666 nm
Laser power: No hazardous radiation is emitted with the
safety protection

DV input:

IEEE 1394 Standard, 4 pin

Power supply: AC 120 V, 60 Hz

Power consumption: 28 W

Dimensions: Approx. 430 (W) × 79 (H) × 285 (D) mm
[Approx. 16^{15/16}"(W) × 3^{1/8}"(H) × 11^{1/4}"(D)]
(excluding protrusions)

Mass: Approx. 3.9 kg (8.58 lbs)

Power consumption in standby mode: approx. 3.2 W

Note

Specifications are subject to change without notice.
Mass and dimensions are approximate.

Product Service

- Damage requiring service**—The unit should be serviced by qualified service personnel if:
 - The AC power supply cord or AC adaptor has been damaged; or
 - Objects or liquids have gotten into the unit; or
 - The unit has been exposed to rain; or
 - The unit does not operate normally or exhibits a marked change in performance; or
 - The unit has been dropped or the cabinet damaged.
- Servicing**—Do not attempt to service the unit beyond that described in these operating instructions. Refer all other servicing to authorized servicing personnel.
- Replacement parts**—When parts need replacing ensure the servicer uses parts specified by the manufacturer or parts that have the same characteristics as the original parts. Unauthorized substitutes may result in fire, electric shock, or other hazards.
- Safety check**—After repairs or service, ask the servicer to perform safety checks to confirm that the unit is in proper working condition.

Limited Warranty (ONLY FOR U.S.A.)

Panasonic Broadcast & Television Systems Company, Unit company of Matsushita Electric Corporation of America

One Panasonic Way
Secaucus, NJ 07094

Panasonic Sales Company, Division of Matsushita Electric of Puerto Rico, Inc.

Ave. 65 de Infantería, Km.9.5
San Gabriel Industrial Park
Carolina, Puerto Rico 00985

PANASONIC DVD RECORDER Limited Warranty

Panasonic Broadcast & Television Systems Company or Panasonic Sales Company (collectively referred to as "the Warrantor") will repair this product and all included accessories with new or refurbished parts, free of charge in the USA or Puerto Rico, from the date of the original purchase in the event of a defect in materials or workmanship as follows:

Parts—New or rebuilt parts in exchange for defective parts for one (1) year from the date of original purchase.

Labor—Carry-in or mail-in service for one (1) year from the date of original purchase.

Batteries—(If included) New rechargeable batteries in exchange for defective rechargeable batteries for ten (10) days from the date of original purchase. Non-rechargeable batteries are not warranted.

4.7 DVD-RAM Disc—(If included) New 4.7 DVD-RAM Disc in exchange for defective disc for ten (10) days from the date of original purchase.

Carry-in or mail-in service in the USA may be obtained during the warranty period by contacting Panasonic Broadcast & Television Systems Company Factory Servicenter listed in the Service Directory or call toll free 1-800-526-6610 to locate an authorized Servicenter.

Carry-in or mail-in service in Puerto Rico can be obtained during the warranty period by calling local service center at 787-750-5135.

This warranty is extended only to the original purchaser. A purchase receipt or other proof of date of original purchase will be required before warranty service is rendered.

This warranty only covers failures due to defects in materials or workmanship, which occur during normal use. The warranty does not cover damage which occurs in shipment, or failures which are caused by products not supplied by the warrantor, or failures which result from accident, misuse, abuse, neglect, mishandling, misapplication, alteration, modification, faulty installation, set-up adjustments, improper antenna, inadequate signal pickup, maladjustment of consumer controls, improper operation, power line surge, improper voltage supply, lightning damage, or service by anyone other than a DVD Recorder authorized repair facility, or damage that is attributable to acts of God.

LIMITS AND EXCLUSIONS

There are no express warranties except as listed above.

THE WARRANTOR SHALL NOT BE LIABLE FOR INCIDENTAL OR CONSEQUENTIAL DAMAGES (INCLUDING, WITHOUT LIMITATION, DAMAGE TO DISCS) RESULTING FROM THE USE OF THIS PRODUCT, OR ARISING OUT OF ANY BREACH OF THE WARRANTY. ALL EXPRESS AND IMPLIED WARRANTIES, INCLUDING THE WARRANTIES OF MERCHANTABILITY AND FITNESS FOR PARTICULAR PURPOSE, ARE LIMITED TO THE APPLICABLE WARRANTY PERIOD SET FORTH ABOVE.

Some states do not allow the exclusion or limitation of incidental or consequential damages, or limitations on how long an implied warranty lasts, so the above exclusions or limitations may not apply to you.

This warranty gives you specific legal rights and you may also have other rights, which vary from state to state.

If you have a problem with this product that is not handled to your satisfaction, then write the Consumer Affairs Department at the Company address indicated above.

Regional Service Offices

Central

1707 N. Randall Rd.
Elgin, IL 60123
847-468-5254

Southern

1225 Northbrook Pkwy
Suite 170
Suwanee, GA 30024
770-338-6858

Northeast

50 Meadowsland Pkwy
Secaucus, NJ 07094
201-348-7975

Western

3330 Cahuenga Blvd. West
Los Angeles, CA 90068
323-436-3507

The model number and serial number of this product can be found on either the back or the bottom of the unit. Please note them in the space provided below and keep for future reference.

MODEL NUMBER _____ LQ-DRM200 _____

SERIAL NUMBER _____

User memo:

DATE OF PURCHASE _____

DEALER NAME _____

DEALER ADDRESS _____

TELEPHONE NUMBER _____

All copy of the card	34	Erase	all program	38	Protection	cartridge	10
Angle	40	folder	36	play list	29, 30	disc	38
Antenna system	7	play list scene	29, 31	program	17, 32	folder	36
Audio attribute	40	still picture	36	still picture	36	program	32
Channel caption	47	Finalize	38			still picture	36
Channel setting	7	Flexible Recording (FR)	15, 42	Quick View	21		
Chasing play	23	Format	card	36	Ratings password	44	
Cleaning		DVD-RAM	38	Re-initialize setting	44	Recording mode	10
disc	53	FUNCTIONS window	42	Repeat play	41	Resume function	16
lens	57	JPEG	11, 53	SD card	11, 18		
main unit	57	Language code list	Back cover	SETUP menu	46		
Clock setting	7	LPCM	45, 53	Shorten Segment	32		
CM Skip	20	Marker	21	Simultaneous rec and play	23		
Connection		MPEG-DNR	41	Sound track	40		
amplifier, system component	50	MP3	22	Still pictures	11		
antenna	52	On-screen display	43	play	18, 19		
antenna, television	5	On-screen menu	40-42	edit	34-37		
cable TV box, satellite receiver	49	PC card	11, 18	Subtitle	40		
video equipment	51	PCM Down Conversion	45	TIFF	11, 53		
CPRM system	53	Picture	41	Time Slip	21, 23		
Dialog Enhancer	41	PLAY FROM TOP	42	Timer recording	24-26		
Direct Navigator	17	Play list	28-31	Transfer	41		
Divide Program	32	Position Memory	17	TV Type	9		
DPOF	36	Progressive	5, 9, 41, 53	VCR Plus+			
DV Automatic Recording (DV AUTO REC)	15	Properties		guide channel	8		
Edit Scenes	30	play list	30	timer recording	24		
Enter title	27	program	32	V.S.S.	41		
disc	38						
folder	35						
play list	30						
program	32						

Language code list Input the code with numbered buttons.

Abkhazian: 6566	Chinese: 9072	Hausa: 7265	Lithuanian: 7684	Romanian: 8279	Telugu: 8469
Afar: 6565	Corsican: 6779	Hebrew: 7387	Macedonian: 7775	Russian: 8285	Thai: 8472
Afrikaans: 6570	Croatian: 7282	Hindi: 7273	Malagasy: 7771	Samoan: 8377	Tibetan: 6679
Albanian: 8381	Czech: 6783	Hungarian: 7285	Malay: 7783	Sanskrit: 8365	Tigrinya: 8473
Ameharic: 6577	Danish: 6865	Icelandic: 7383	Malayalam: 7776	Scots Gaelic: 7168	Tonga: 8479
Arabic: 6582	Dutch: 7876	Indonesian: 7378	Maltese: 7784	Serbian: 8382	Turkish: 8482
Armenian: 7289	English: 6978	Interlingua: 7365	Maori: 7773	Serbo-Croatian: 8372	Turkmen: 8475
Assamese: 6583	Esperanto: 6979	Irish: 7165	Marathi: 7782	Shona: 8378	Twi: 8487
Aymara: 6588	Estonian: 6984	Italian: 7384	Moldavian: 7779	Sindhi: 8368	Ukrainian: 8575
Azerbaijani: 6590	Faroese: 7079	Japanese: 7465	Mongolian: 7778	Singhalese: 8373	Urdu: 8582
Bashkir: 6665	Fiji: 7074	Javanese: 7487	Nauru: 7865	Slovak: 8375	Uzbek: 8590
Basque: 6985	Finnish: 7073	Kannada: 7578	Nepali: 7869	Slovenian: 8376	Vietnamese: 8673
Bengali, Bangla: 6678	French: 7082	Kashmiri: 7583	Norwegian: 7879	Somali: 8379	Volapük: 8679
Bhutani: 6890	Frisian: 7089	Kazakh: 7575	Oriya: 7982	Spanish: 6983	Welsh: 6789
Bihari: 6672	Galician: 7176	Kirghiz: 7589	Pashto, Pushto: 8083	Sundanese: 8385	Wolof: 8779
Breton: 6682	Georgian: 7565	Korean: 7579	Persian: 7065	Swahili: 8387	Xhosa: 8872
Bulgarian: 6671	German: 6869	Kurdish: 7585	Polish: 8076	Swedish: 8386	Yiddish: 7473
Burmese: 7789	Greek: 6976	Laotian: 7679	Portuguese: 8084	Tagalog: 8476	Yoruba: 8979
Byelorussian: 6669	Greenlandic: 7576	Latin: 7665	Punjabi: 8065	Tajik: 8471	Zulu: 9085
Cambodian: 7577	Guarani: 7178	Latvian, Lettish: 7686	Quechua: 8185	Tamil: 8465	
Catalan: 6765	Gujarati: 7185	Lingala: 7678	Rhaeto-Romance: 8277	Tatar: 8484	

Apparatus Claims of U.S. Patent Nos. 4,631,603, 4,577,216, and 4,819,098, licensed for limited viewing uses only.

This product incorporates copyright protection technology that is protected by method claims of certain U.S. patents and other intellectual property rights owned by Macrovision Corporation and other rights owners. Use of this copyright protection technology must be authorized by Macrovision Corporation, and is intended for home and other limited viewing uses only unless otherwise authorized by Macrovision Corporation. Reverse engineering or disassembly is prohibited.

Panasonic Broadcast & Television Systems Company,
Unit company of Matsushita Electric Corporation of America
 One Panasonic Way
 Secaucus, NJ 07094

Panasonic Sales Company,
Division of Matsushita Electric of Puerto Rico, Inc. ("PSC")
 Ave. 65 de Infantería, Km. 9.5
 San Gabriel Industrial Park, Carolina,
 Puerto Rico 00985

Panasonic Canada Inc.
 5770 Ambler Drive
 Mississauga, Ontario
 L4W 2T3
www.panasonic.ca

