

Panasonic®

Portable DVD/SD/CD Player

Operating Instructions

Model No. **DVD-LX9**

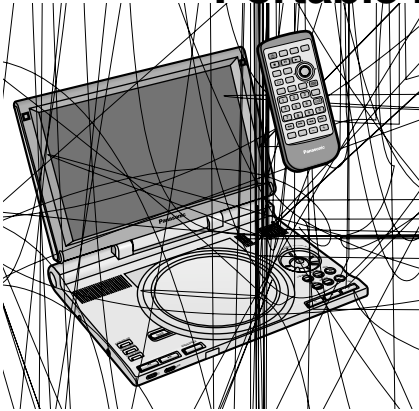

WARNING:

TO REDUCE THE RISK OF FIRE, ELECTRIC SHOCK OR PRODUCT DAMAGE, DO NOT EXPOSE THIS APPARATUS TO RAIN, MOISTURE, DRIPPING OR SPLASHING AND THAT NO OBJECTS FILLED WITH LIQUIDS, SUCH AS VASES, SHALL BE PLACED ON THE APPARATUS.

CAUTION!

THIS PRODUCT UTILIZES A LASER. USE OF CONTROLS OR ADJUSTMENTS OR PERFORMANCE OF PROCEDURES OTHER THAN THOSE SPECIFIED HEREIN MAY RESULT IN HAZARDOUS RADIATION EXPOSURE. DO NOT OPEN COVERS AND DO NOT REPAIR YOURSELF. REFER SERVICING TO QUALIFIED PERSONNEL.

CAUTION!

DO NOT INSTALL OR PLACE THIS UNIT IN A BOOKCASE, BUILT-IN CABINET OR IN ANOTHER CONFINED SPACE. ENSURE THE UNIT IS WELL VENTILATED. TO PREVENT RISK OF ELECTRIC SHOCK OR FIRE HAZARD DUE TO OVERHEATING, ENSURE THAT CURTAINS AND ANY OTHER MATERIALS DO NOT OBSTRUCT THE VENTILATION VENTS.

CAUTION – VISIBLE AND INVISIBLE LASER RADIATION WHEN OPEN.
DO NOT STARE INTO BEAM.

ATTENTION – RAYONNEMENT LASER VISIBLE ET INVISIBLE EN CAS D'OUVERTURE.
NE PAS REGARDER DANS LE FAISCEAU.

(Bottom of product)

THE FOLLOWING APPLIES ONLY IN THE U.S.A.

CAUTION:

This equipment has been tested and found to comply with the limits for a Class B digital device, pursuant to Part 15 of the FCC Rules. These limits are designed to provide reasonable protection against harmful interference in a residential installation. This equipment generates, uses and can radiate radio frequency energy and, if not installed and used in accordance with the instructions, may cause harmful interference to radio communications. However, there is no guarantee that interference will not occur in a particular installation. If this equipment does cause harmful interference to radio or television reception, which can be determined by turning the equipment off and on, the user is encouraged to try to correct the interference by one or more of the following measures:

The following mark and symbols are located on bottom of the unit.



CAUTION
RISK OF ELECTRIC SHOCK
DO NOT OPEN



CAUTION: TO REDUCE THE RISK OF ELECTRIC SHOCK, DO NOT REMOVE SCREWS. NO USER-SERVICEABLE PARTS INSIDE. REFER SERVICING TO QUALIFIED SERVICE PERSONNEL.



The lightning flash with arrowhead symbol, within an equilateral triangle, is intended to alert the user to the presence of uninsulated "dangerous voltage" within the product's enclosure that may be of sufficient magnitude to constitute a risk of electric shock to persons.



The exclamation point within an equilateral triangle is intended to alert the user to the presence of important operating and maintenance (servicing) instructions in the literature accompanying the appliance.

Marking sign is located on bottom of the unit.

- Reorient or relocate the receiving antenna.
- Increase the separation between the equipment and receiver.
- Connect the equipment into an outlet on a circuit different from that to which the receiver is connected.
- Consult the dealer or an experienced radio/TV technician for help.

Any unauthorized changes or modifications to this equipment would void the user's authority to operate this device.

This device complies with Part 15 of the FCC Rules. Operation is subject to the following two conditions: (1) This device may not cause harmful interference, and (2) this device must accept any interference received, including interference that may cause undesired operation.

Batteries

1. Battery pack (Lithium ion battery pack)

- Use this unit to recharge the battery pack.
- Do not use the battery pack with equipment other than the specified player.
- Do not use the player outside if it is snowing or raining. (The battery pack is not waterproof.)
- Do not get dirt, sand, liquids, or other foreign matter on the terminals.
- Do not touch the plug terminals (+ and -) with metal objects.
- Do not disassemble, remodel, heat or throw into fire.

2. Button-type battery (Lithium battery)

- Insert with poles aligned.
- Do not touch the terminals (+ and -) with metal objects.
- Do not disassemble, remodel, heat or throw into fire.
- Keep out of reach of children.

If any electrolyte should come into contact with your hands or clothes, wash it off thoroughly with water.

If any electrolyte should come into contact with your eyes, never rub the eyes.

Rinse eyes thoroughly with water, and then consult a doctor.

3. Disposing of the batteries

Check and follow your local regulations before disposal.

CAUTION:

Use only Panasonic car adaptor
DY-DC95.

A lithium ion/polymer battery that is recyclable powers the product purchased. Please call 1-800-828-8228 for information on how to recycle your battery.



CAUTION:

The batteries used in this device may present a risk of fire or chemical burn if mistreated. Do not disassemble or incinerate the batteries. Do not heat the batteries above the following temperatures.

Button-type battery 100 °C (212 °F)

Battery pack 60 °C (140 °F)

Do not recharge the button-type battery.

Replace only with Panasonic part number as indicated below:

Button-type battery (Lithium battery)

(for remote control)

CR2025

Battery pack

(Lithium ion battery pack)

CGR-H604

Optional battery pack

(Lithium ion battery pack)

CGP-H501

Use of other batteries may present a risk of fire or explosion.

THE FOLLOWING APPLIES ONLY IN THE U.S.A.

Notice:

This product has parts that contains a small amount of mercury. It also contains lead in some components. Disposal of these materials may be regulated in your community due to environmental considerations. For disposal or recycling information please contact your local authorities, or the Electronics Industries Alliance: <<http://www.eiae.org>>

Accessories



Please check and identify the supplied accessories.

Use numbers indicated in parentheses when asking for replacement parts.

(For U.S.A.) To order accessories contact 1-800-332-5368 or the website (<http://www.panasonic.com>).

(For Canada) To order accessories, call the dealer from whom you have made your purchase.

- Remote control 1
(N2QAJC000005)



- Button-type battery 1
for remote control
(for replacement, see right)



- Audio/video cable 1
(K2KA6CB00003)



- AC adaptor 1
(RFEA905W-W)

- AC power supply cord 1
(RJA0065-A)

- Rechargeable battery pack 1
(attached upon shipment)
(for replacement, see right)

- Multi cradle 1
(RAQ0032A)

- Speakers 2
(RYQ0446-S)

Optional accessories:

Button-type battery (CR2025)

Replacement rechargeable battery pack
(CGR-H604: Available from Panasonic
dealers.)

Optional rechargeable battery pack (CGP-H501)

Car stereo cassette adaptor (RP-CC20)

Car adaptor (DY-DC95)

Mini optical digital audio cable (RP-CA2120)

Available only in U.S.A.

Headphones (RP-HC100 or RP-HC70)

Note

The included AC power supply cord and AC adaptor are for use with this unit only. Do not use them with other equipment.

Operations in these instructions are described mainly with the main unit, but you can do the operations on the remote control if the controls are the same (➡ page 10).

Table of contents

Getting Started

Accessories	4
IMPORTANT SAFETY INSTRUCTIONS	6
Disc and Card information	8
Control reference guide	10
Adjusting the angle of the LCD	11
Preparing the multi cradle and power supply	12
Multi cradle (AC adaptor)	12
Battery pack	13
Car adaptor	15
The remote control	15

Basic Operations

Playing discs	16
Playing SD cards	18
Playing the programs or play lists on DVD-RAM	22
WMA/MP3, CD text and JPEG navigation menus	23
Playing HighMAT discs	25
Convenient features	26
Starting play from a selected program, title, track or picture	26
Selecting still pictures—Page Skip	26
Rotating pictures	26
Selecting groups to play	26
Changing the play sequence	27
A-B Repeat	28
Repeat play	28
Marker	29
Increasing your enjoyment of movies	29
Advanced Surround	29
Changing soundtracks, subtitle languages and angles	30

Advanced Operations

Changing the monitor settings	31
Changing the size of the picture	31
Picture quality	31
Using On-Screen Menu Icons	32
Common procedures	32
Progress indicator	32
Disc information	33
Unit information	34
Using this unit with other equipment	35
Enjoying more powerful sound	35
Using this unit with a television	36
Watching video from a video camera	37
Recording to digital recording equipment or cassette tapes	38
Changing settings	38
Common procedures	38
Language code list	42

Reference

Maintenance	42
Troubleshooting Guide	43
Glossary	46
Product Service	46
Specifications	47
Limited Warranty (ONLY FOR U.S.A.)	48

IMPORTANT SAFETY INSTRUCTIONS

Read these operating instructions carefully before using the unit. Follow the safety instructions on the unit and the applicable safety instructions listed below. Keep these operating instructions handy for future reference.

- 1) Read these instructions.
- 2) Keep these instructions.
- 3) Heed all warnings.
- 4) Follow all instructions.
- 5) Do not use this apparatus near water.
- 6) Clean only with dry cloth.
- 7) Do not block any ventilation openings. Install in accordance with the manufacturer's instructions.
- 8) Do not install near any heat sources such as radiators, heat registers, stoves, or other apparatus (including amplifiers) that produce heat.
- 9) Do not defeat the safety purpose of the polarized or grounding-type plug. A polarized plug has two blades with one wider than the other. A grounding-type plug has two blades and a third grounding prong. The wide blade or the third prong are provided for your safety. If the provided plug does not fit into your outlet, consult an electrician for replacement of the obsolete outlet.
- 10) Protect the power cord from being walked on or pinched particularly at plugs, convenience receptacles, and the point where they exit from the apparatus.
- 11) Only use attachments/accessories specified by the manufacturer.
- 12) Use only with the cart, stand, tripod, bracket, or table specified by the manufacturer, or sold with the apparatus. When a cart is used, use caution when moving the cart/apparatus combination to avoid injury from tip-over.
- 13) Unplug this apparatus during lightning storms or when unused for long periods of time.
- 14) Refer all servicing to qualified service personnel. Servicing is required when the apparatus has been damaged in any way, such as power-supply cord or plug is damaged, liquid has been spilled or objects have fallen into the apparatus, the apparatus has been exposed to rain or moisture, does not operate normally, or has been dropped.



Do not rest the unit on your lap for a long time while using it. The unit can become hot and cause burns.

To prevent damage

Avoid the following;

- Spraying flammable insecticides near the unit.
- Pressing the LCD.
- Touching the lens and other parts of the laser pickup.

Do not use the unit in the following places;

- Where the temperature is below 5 °C (41 °F) or above 35 °C (95 °F). (Operating the unit beyond this range can cause the protection circuitry to function and render the unit inoperable.)
- Sandy places such as beaches.
- On top of cushions, sofas, or hot equipment such as amplifiers.

Listening caution



Do not play your headphones or earphones at a high volume. Hearing experts advise against continuous extended play.

If you experience a ringing in your ears, reduce volume or discontinue use.

Do not use while operating a motorized vehicle. It may create a traffic hazard and is illegal in many areas.

You should use extreme caution or temporarily discontinue use in potentially hazardous situations.

Even if your headphones or earphones are the open-air type designed to let you hear outside sounds, don't turn up the volume so high that you can't hear what's around you.

Sound can be deceiving. Over time your hearing "comfort level" adapts to higher volumes of sound. So what sounds "normal" can actually be loud and harmful to your hearing.

Guard against this by setting your equipment at a safe level BEFORE your hearing adapts.

To establish a safe level:

- Start your volume control at a low setting.
- Slowly increase the sound until you can hear it comfortably and clearly, and without distortion. Once you have established a comfortable sound level:
- Leave it there.

The model number and serial number of this product can be found on either the back or the bottom of the unit.

Please note them in the space provided below and keep for future reference.

MODEL NUMBER _____ DVD-LX9 _____

SERIAL NUMBER _____

Manufactured under license from Dolby Laboratories.

"Dolby", "Pro Logic" and the double-D symbol are trademarks of Dolby Laboratories.

MPEG Layer-3 audio decoding technology licensed from Fraunhofer IIS and Thomson multimedia.

User memo:

DATE OF PURCHASE _____

DEALER NAME _____

DEALER ADDRESS _____

TELEPHONE NUMBER _____









Manufactured under license from Digital Theater Systems, Inc. US Pat. No. 5,451,942, 5,956,674, 5,974,380, 5,978,762 and other world-wide patents issued and pending. "DTS" and "DTS Digital Surround" are registered trademarks of Digital Theater Systems, Inc. © 1996, 2000 Digital Theater Systems, Inc. All rights reserved.

Apparatus Claims of U.S. Patent Nos. 4,631,603, 4,577,216, and 4,819,098, licensed for limited viewing uses only.

This product incorporates copyright protection technology that is protected by method claims of certain U.S. patents and other intellectual property rights owned by Macrovision Corporation and other rights owners. Use of this copyright protection technology must be authorized by Macrovision Corporation, and is intended for home and other limited viewing uses only unless otherwise authorized by Macrovision Corporation. Reverse engineering or disassembly is prohibited.

Discs

■ Discs that can be played

DVD-RAM	DVD-Audio	DVD-Video	Video CD	CD	CD-R/RW
		  DVD-R 	 SVCD  (conforming to IEC62107)	 	—
RAM	DVD-A	DVD-V	VCD	CD	WMA MP3 JPEG

Use discs with the above logos and that conform to specifications. The unit cannot play other discs correctly.

Do not use irregularly shaped discs (e.g. heart-shaped), as these can damage the unit.

It may not be possible to play CD-R, CD-RW, DVD-R and DVD-RAM in all cases due to the type of disc or condition of the recording.

■ Discs that cannot be played

PAL discs (DVD-Audio can be played.), DVD-ROM, CD-ROM, CDV, CD-G, +RW, DVD-RW, CVD, SACD, Divx Video Discs, Photo CD, DVD-RAM that cannot be removed from their cartridge, 2.6-GB and 5.2-GB DVD-RAM, and "Chaoji VCD" available on the market including CVD, DVCD and SVCD that do not conform to IEC62107.

■ Built-in decoders



This unit can play discs with these symbols.

■ Video systems

NTSC is used. This unit converts still picture parts of PAL system DVD-Audio to NTSC for play on NTSC television. The picture is compressed to show it in its entirety, but this may cause it to be stretched vertically.

■ Playing DVDs and Video CDs

The producer of these discs can control how they are played so you may not always be able to control play as described in these operating instructions (for example if the play time is not displayed or if a Video CD has menus). Read the disc's instructions carefully.

■ CD-R and CD-RW discs

This unit can play CD-R/RW (audio recording disc) recorded with CD-DA, video CD, SVCD (conforming to IEC62107), WMA, MP3, or JPEG. Close the session or finalize after recording.

See page 24 for more information about WMA, MP3, and JPEG.

HighMAT discs (→ page 25)

■ DVD-R discs

Panasonic DVD-R recorded and finalized on a Panasonic DVD video recorder or DVD video camera are played as DVD-Video on this unit.

■ DVD-RAM discs

The DVD-RAM you can play on this unit are those recorded with DVD video recorders, DVD video cameras, personal computers, etc. using Version 1.1 of the Video Recording Format (a unified video recording standard).

- Remove discs from their cartridges before use and return them when you are finished, making sure that the labels of the disc and cartridge face the same way.
- Some parts of the disc, for example where one program ends and another begins, may not play smoothly.

■ To clean discs

DVD-Audio, DVD-Video, Video CD, CD

Wipe with a damp cloth and then wipe dry.

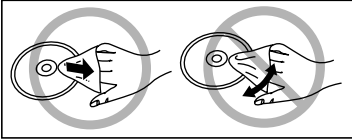

DVD-RAM, DVD-R

- Clean with an optional DVD-RAM/PD disc cleaner (LF-K200DCA1, where available).
- Never use cloths or cleaners for CDs, etc.

■ Handling precautions

- Do not write on the label side with a ball-point pen or other writing instrument.
- Do not use record cleaning sprays, benzene, thinner, static electricity prevention liquids or any other solvent.
- Do not attach labels or stickers to discs.
- Do not use discs with exposed adhesive from tape or left over peeled off stickers.
- Do not use scratch-proof protectors or covers.
- Do not use discs printed with label printers available on the market.

Cards

■ Cards that can be played



- Play may not be possible sometimes due to the condition of the data.
- Operation is not guaranteed with MultiMediaCard.
- Do not eject the card or unplug the AC adaptor while the unit is using the card. This can corrupt your data.

■ Handling precautions

Do not detach the label and do not attach other labels.

- SD logo is a trademark.
- Portions of this product are protected under copyright law and are provided under license by ARIS/SOLANA/4C.
- Licensed AAC Patents (U.S. patent numbers);

08/937,950	5,394,473	5,579,430
5,481,614	5,299,238	5,581,654
5848391	5,583,962	08/678,666
5,592,584	5,299,239	05-183,988
5,291,557	5,274,740	98/03037
5,781,888	5,299,240	5,548,574
5,451,954	5,633,981	97/02875
08/039,478	5,197,087	08/506,729
5 400 433	5 297 236	97/02874
08/211,547	5,490,170	08/576,495
5,222,189	4,914,701	98/03036
5,703,999	5,264,846	5,717,821
5,357,594	5,235,671	5,227,788
08/557,046	5,268,685	08/392,756
5 752 225	07/640,550	5,285,498
08/894,844	5,375,189	

■ Main unit

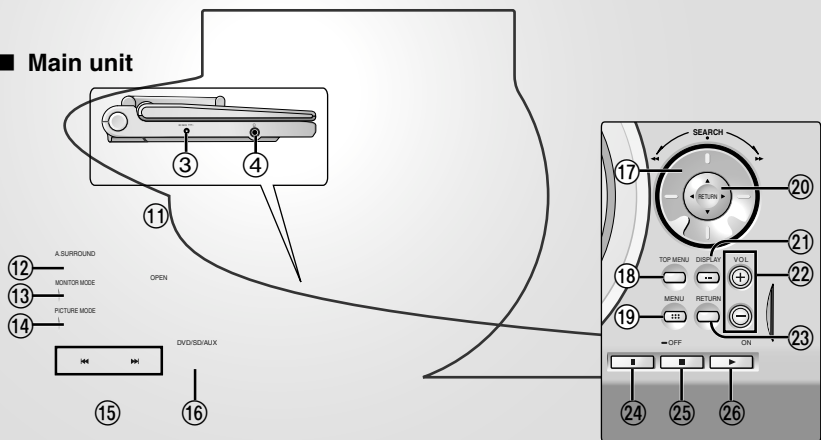

■ Multi cradle

Left side



Right side

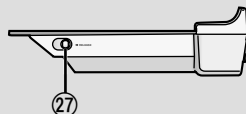

Buttons and terminals such as 3 function the same as the controls on the unit.

- | | |
|---|--|
| ① 9-inch wide screen LCD | ⑮ Skip buttons (◀◀, ▶▶) 17 |
| ② Stereo speakers | ⑯ Input select button (DVD/SD/AUX) 16 |
| ③ DC IN terminal (DC IN) 12 | ⑰ Shuttle dial (◀◀ SEARCH ▶▶) 17 |
| ④ Headphone jack (🔊) 16 | ⑱ Top menu button (TOP MENU) 17, 22 |
| ⑤ Standby indicator (⏻) 13 | ⑲ Menu button (MENU) 17, 22, 38 |
| ⑥ Charge indicator (CHG) 13 | ⑳ Cursor jockey (▲, ▼, ◀, ▶) / Enter button (ENTER) 17 |
| ⑦ Remote control signal sensor | Move the cursor jockey in the direction you want to move the cursor. |
| ⑧ Card slot 19 | You can turn the cursor jockey's light on and off (⇒ page 31, "BLUE LED"). |
| ⑨ Video output/input terminal (VIDEO) 36 | ㉑ Display button (DISPLAY) 13, 32 |
| ⑩ Audio output/input, Optical digital output terminal (AUDIO, OPT OUT) 35, 36 | ㉒ Volume buttons (VOL +, -) 16 |
| ⑪ Disc lid open button (OPEN) 16 | ㉓ Return button (RETURN) 17 |
| ⑫ Advanced surround button (A.SURROUND) 29 | ㉔ Pause button (⏸) 17 |
| ⑬ Monitor mode button (MONITOR MODE) 31 | ㉕ Stop/Off button (■, - OFF) 17 |
| ⑭ Picture mode button (PICTURE MODE) 31 | ㉖ Play/On button (▶, ON) 16 |
| | ㉗ Release lever (◀ RELEASE) 12 |

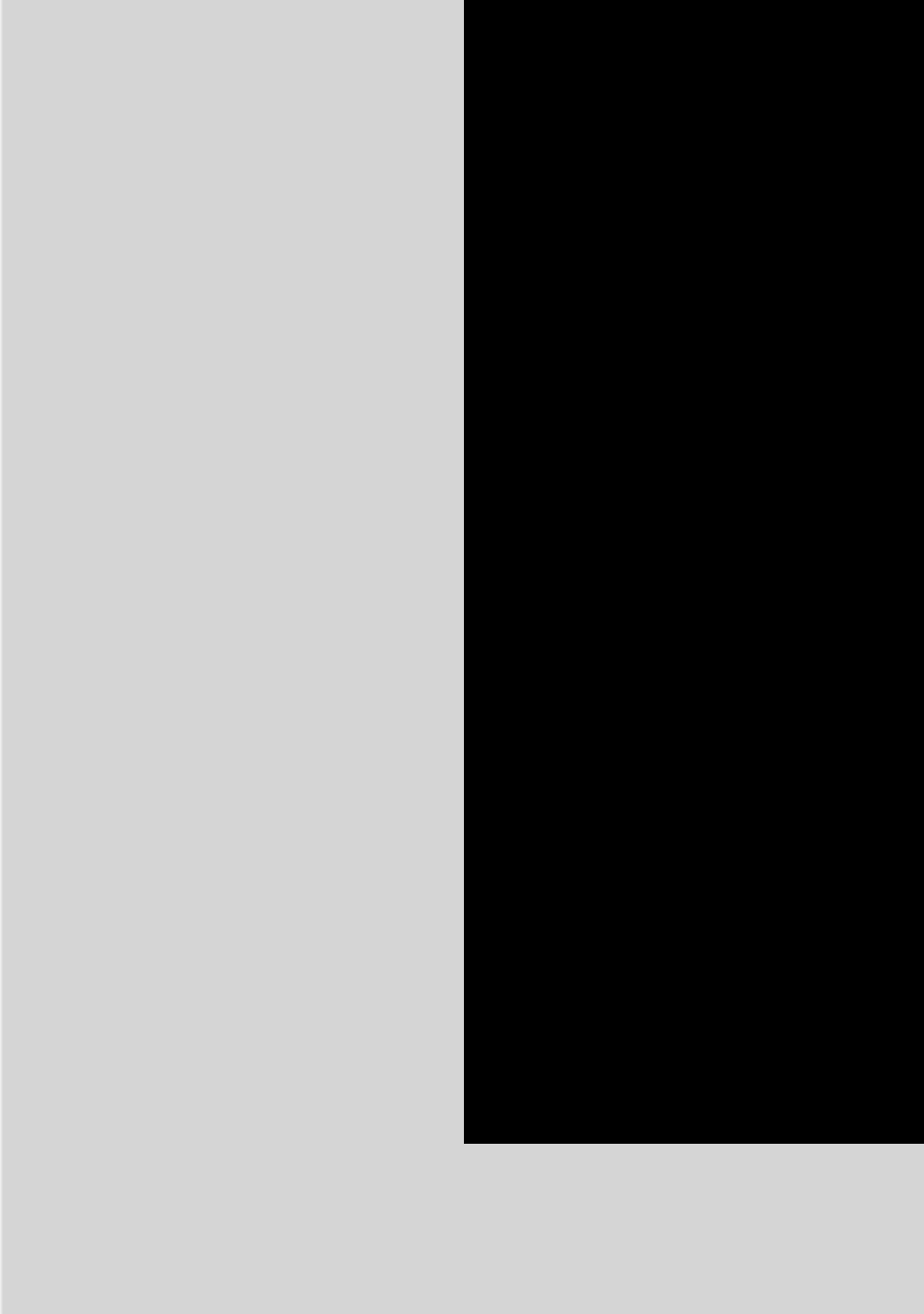

Preparing the multi cradle and power supply

BEFORE USE

Remove the insulation sheet

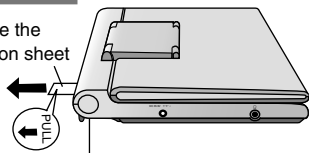

Make sure the built-in battery is attached whenever you use the unit.

Multi cradle (AC adaptor)

- 1 Unwind speaker wire, then fit the wire back into the groove of the speaker base.
- 2 Twist and pull off the vinyl tip.

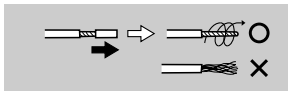

- 3 Connect the speakers.

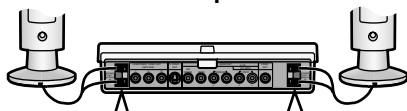

Push the levers and insert the wires.

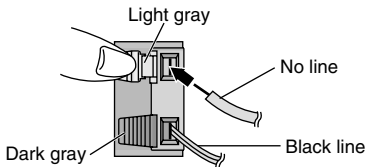

Caution

Use the speakers only with the recommended system. Failure to do so may lead to damage to the connected equipment and/or the speakers, and may result in the risk of fire. Consult a qualified service person if damage has occurred or if you experience a sudden change in performance.



- 4 Attach to cradle. (When the unit is off)

Make sure built-in battery is attached.

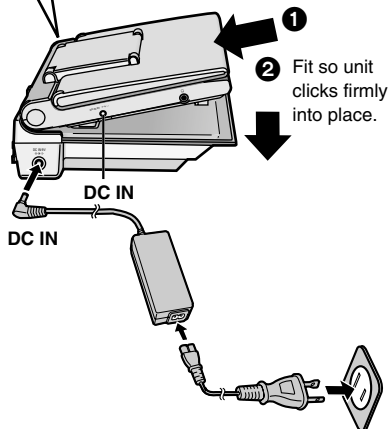

Household AC outlet
(AC 120 V, 60 Hz)

When using only the player

Connect the AC adaptor directly to the player's DC IN terminal.

The unit is in the standby condition (the [D] indicator lights) when the AC power supply cord is connected. The primary circuit is always "live" as long as the AC adaptor is connected to an electrical outlet.

•To conserve power

When the unit is not going to be used for a long time, disconnect the AC power supply cord from the AC outlet.

The unit consumes a small amount of power (approx. 0.9 W, when in the multi cradle) when in standby mode.

- To detach (When the unit is off)

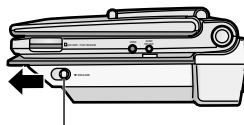

Pull the lever so the unit lifts off the cradle.

Battery pack (Lithium ion battery pack)

- Charge the battery pack before using it for the first time.
- Use together with the optional battery pack (⇒ page 14) for longer play.
- For replacement (⇒ page 4)

■ To recharge (When the unit is off)

Attach the unit to the multi cradle (⇒ left).

- You can also connect the AC adaptor directly to the player to recharge the battery.

Recharging

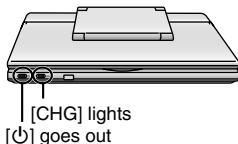

Recharging is complete when [CHG] goes out. ([⏻] lights.)

■ Recharging and play times

Times shown are approximate. Actual times depend on operating conditions.

Recharging [at 20 °C (68 °F)]: 4 (13) hours

Play (in hours, at room temperature, using headphones)

	LCD brightness level			LCD off
	-5	0 (factory preset)	+5	
DVD	2.5 (7.5)	2 (6)	1.5 (4.5)	3.5 (10.5)
SD	3 (9)	2.5 (7.5)	2 (6)	8 (24)

- Times for when used along with the optional battery pack are in parentheses.
- To change the LCD brightness (⇒ page 31).

■ To confirm the battery charge

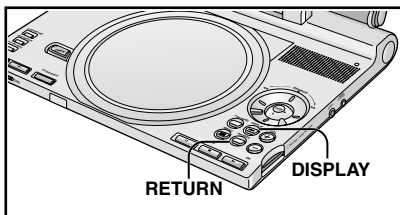

When the unit is on and powered by the battery pack

Press [DISPLAY].

The battery display appears on the LCD for a few seconds to show the approximate remaining charge.



Full

Low

Recharge

(Appears automatically when there is a few minutes of charge remaining.)

- Press [RETURN] to clear the on-screen menu icons.

■ If the unit is not to be used for a long time

- Detach the battery pack. (Even if the unit is off, it still uses some power. This can drain the battery completely and lead to a malfunction.)
- Recharge the battery pack when you are ready to use it again.

Battery pack (Lithium ion battery pack)

- To detach the built-in battery pack (When the unit is off)

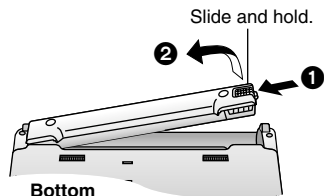

- To attach (When the unit is off)

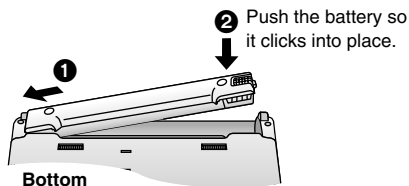

- To attach the optional battery pack (When the unit is off)

Use together with built-in battery pack.

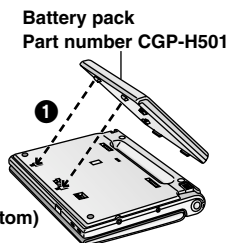

Slide the pack so it clicks and locks into place.

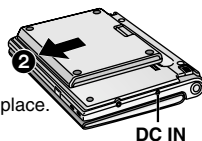

- Connect the AC adaptor directly to the player's DC IN terminal to recharge the battery pack.

- To detach (When the unit is off)

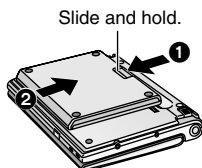

Car adaptor (optional)

This unit (Left side)

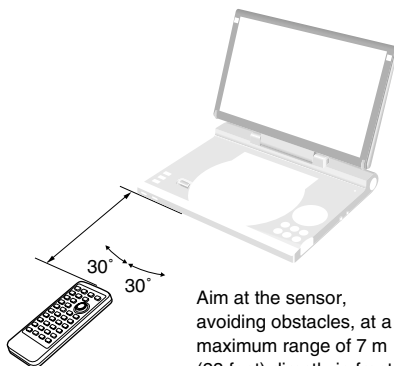
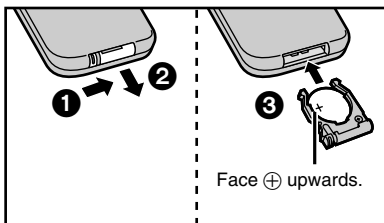
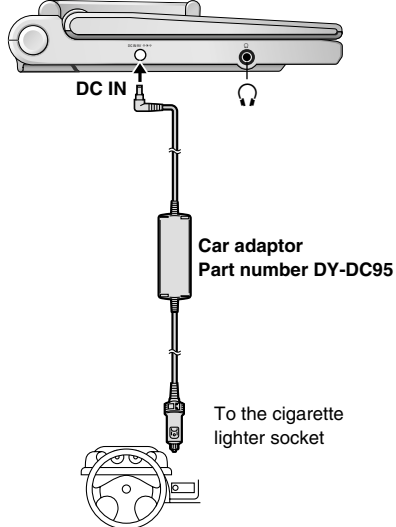

Aim at the sensor, avoiding obstacles, at a maximum range of 7 m (23 feet) directly in front of the unit.

Note

- Read the car adaptor's operating instructions carefully.
- In the interests of the traffic safety, do not perform operations on the unit or watch video while driving a vehicle.
- You can enjoy sound through your car audio system by connecting a car stereo cassette adaptor (➔ page 4) to this unit's headphone jack.

Stop	Press [■]. "▷" flashes on the display. Press [▶] (Play) to restart from this position or [■] to clear it. DVD-Video: Press [▶] (Play) again to review chapters (⇨ below).
Pause	Press [⏸]. Press [▶] (Play) to restart.
Skip	Press [◀◀] (backward) or [▶▶] (forward). Group skip JPEG Use [▼] (backward) or [▲] (forward).
Search	<Main unit> Turn the shuttle dial. Release the shuttle dial to restart play. <Remote control> Press [◀◀] (backward) or [▶▶] (forward). Press [▶] (Play) to restart play. You can turn off the sound during search (⇨ page 40, Audio—Audio during Search).
Slow-motion	While paused <Main unit> Turn the shuttle dial. <Remote control> Press [◀◀] (backward) or [▶▶] (forward). ● Press [▶] (Play) to restart play.
Frame-by-frame	While paused, use [◀] (backward) or [▶] (forward). Move and hold to change in succession. Or, press [⏸] repeatedly for forward frame-by-frame.
Menus	Use [▲, ▼, ◀, ▶] to select an item and [ENTER] to confirm. Or, press the numbered buttons. To return to the menu DVD-A Press [TOP MENU]. DVD-V Press [TOP MENU] or [MENU]. VCD Press [RETURN].

Notes

- The speed of search and slow-motion increases up to 5 steps.
- Slow-motion and frame-by-frame only work on moving pictures.

When playing Video CDs

- You cannot move backwards during frame-by-frame and slow-motion.
- Turning the shuttle dial or pressing buttons to perform skip, search or slow-motion may take you to a menu screen.

Chapter Preview DVD-V

The following message appears immediately after you press [▶] (Play).

Press PLAY to Preview Chapters

Press [▶] (Play) while the message is displayed and the beginning portions of each chapter up to the current one are played. Full play resumes from the point where you stopped play. (This feature works only within a title.) If you do not press [▶] (Play), the message disappears and play starts from where you stopped it.

To turn the unit off

Press and hold [■, - OFF] until "OFF" appears on the LCD.

Turning the unit on and off with the remote control

Press [⏻].

- You cannot use the remote control to turn the unit on when powered by the battery pack.

Auto standby function

The unit automatically turns off after being stopped for 15 minutes (5 minutes when the battery pack is being used).

Playing SD cards

You can play the following types of data recorded on an SD Memory Card:

Still pictures



JPEG files taken on digital cameras conforming to DCF standards (set down by the Japan Electronics and Information Technology Industries Association).

Moving pictures

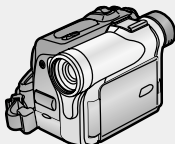

MPEG4 files (ASF format) taken on a digital video camera or SD Multi AV Device.

Music

MP3 and **AAC** audio files recorded with "Panasonic Media Manager" or "SD-Jukebox", software included with Panasonic SD Multi AV Device and SD Audio Player.

Voice

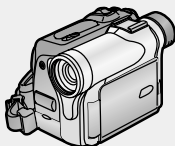

G.726 files recorded on a digital video camera or SD Multi AV Device.



SD Memory Card

Some files are not compatible with this unit and cannot be played back. For example:
–Moving picture files recorded using a digital still camera with moving picture function
–IC recorder voice files etc

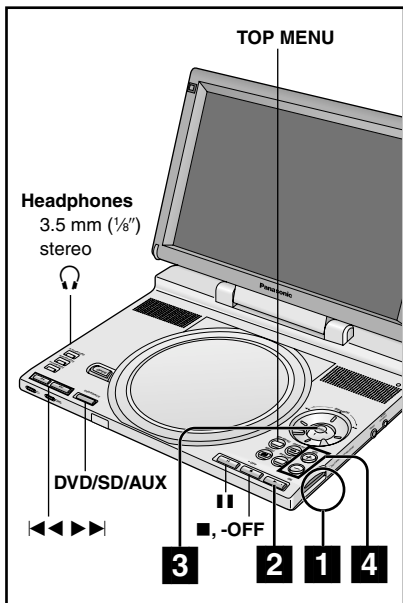

1 Insert and slide the card until it clicks into place.

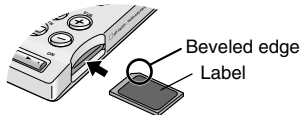

- To remove, press on the center of the card to unlock, then pull straight out.

2 Press and hold [PAUSE, ON] to turn the unit on.

When a source other than SD is selected
Press [DVD/SD/AUX] to select "SD".

3 **1** Use [▲, ▼] to select the mode and press [ENTER].

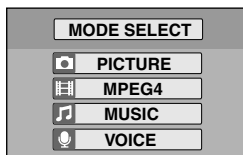

2 Use [▲, ▼, ◀, ▶] to select a file and press [ENTER].

PICTURE

Press [◀◀, ▶▶] to show other pictures.

4 Adjust the volume.

Using headphones

Turn down the volume before connection, and then adjust the level.

To stop and return to the list

Press [■].

To pause play

Press [||] during play.

Press [▶] (Play) to restart play.

To change the mode

Press [TOP MENU] then select the mode.

To turn the unit off

Press and hold [■, -OFF] until "OFF" appears on the LCD.

Turning the unit on and off with the remote control

Press [⏻].

- You cannot use the remote control to turn the unit on when powered by the battery pack.

Note

- Menus and pictures may take some time to appear.

MUSIC

If you have attached still pictures to an audio file (using SD-Jukebox Ver. 3.0) the unit can also show the first of these pictures.

Do not face the slot towards your face when inserting and removing cards. The slot mechanism has a spring so the card may eject with force.

ing SD cards 

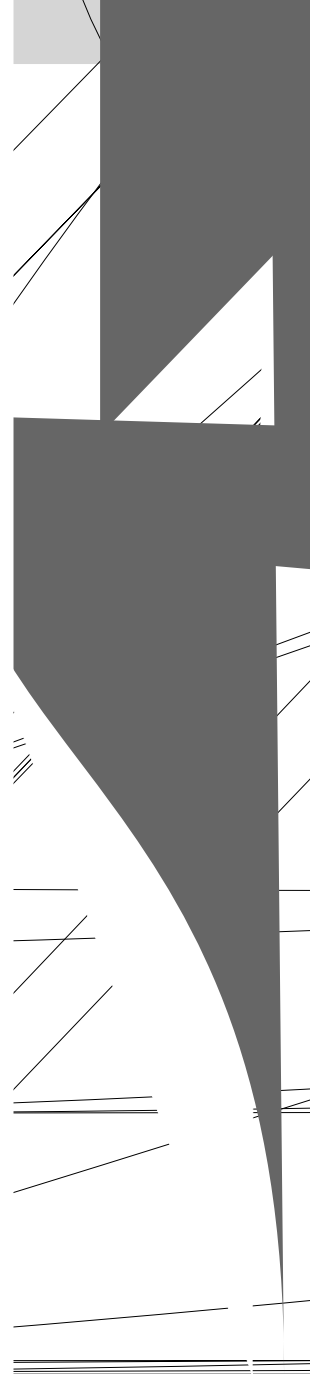
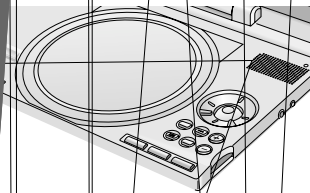

Playing play lists

MUSIC

You can play the play lists you created with "SD-Jukebox".

1. While the menu is on the screen
Press [▲, ▼] to select "SELECT PLAYLIST"
and press [ENTER].

Example:

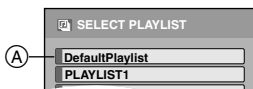

2. Press [▲, ▼] to select the play list and press [ENTER].

Select the first play list (A) to play all the tracks recorded on the card.

Zooming pictures

MPEG4

1. While the menu is on the screen
Press [▲, ▼] to select "SCREEN".
 2. Press [◀, ▶] to change the size.
FULL (zoom) ↔ NORMAL
- Picture quality worsens and parts of the picture may be cut off when you select "FULL".

To close the menu screen

Press [MENU].

■ Recording to an SD card on a computer

You can copy still and moving pictures to your SD card by connecting it to a computer with a USB Reader/Writer (BN-SDCAP) or PC card adapter (BN-SDABP).

Create folders as shown below.

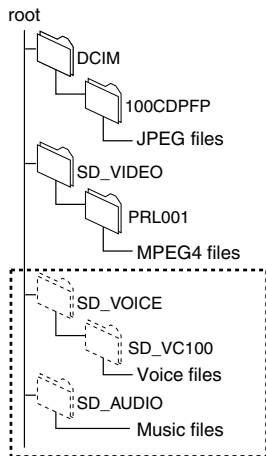

Naming files

JPEG still pictures

Example:

IMGA0001.JPG

Four characters

Four numbers

MPEG 4 moving pictures

Example:

MOL001.ASF

Three characters (numerals 0 to 9 and letters A to F: hexadecimal name)

Ensure that none of the files in a folder have the same last 4 (or 3) characters. Files so named cannot be played.

- SD_VOICE and SD_AUDIO are hidden folders created when you record voice or audio files, and play automatically on other equipment.
- This unit needs the folders on SD cards to play the files. Do not delete them on your computer.

● "DCIM", "SD_VIDEO", "SD_VOICE" and "SD_AUDIO" are necessary to play files but have no effect on operation.

● You may be unable to play some files due to the origin of the copy, or the naming of folders and files.



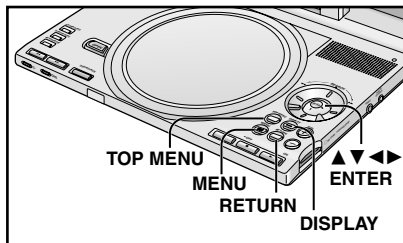

To use the contents screen to find a track **CD** (CD text only)

You can use the text information recorded on these discs to find a track to play.

- 1 While the menu is displayed Use **[▶]** while a track is highlighted to display the contents screen.

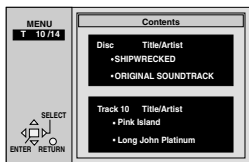

- 2 Use **[◀, ▶]** to move through the tracks and press **[ENTER]**.

To use the tree screen to find a group **WMA** **MP3** **JPEG**

- 1 While the menu is displayed **WMA** **MP3** Use **[▶]** while a track is highlighted to display a tree screen.

JPEG

Use **[▲, ▼, ◀, ▶]** to select "Tree" and press **[ENTER]**.

- 2 Use **[▲, ▼]** to select a group and press **[ENTER]**.

The audio navigation menu/album display for the group appears.

To return to the menu
Press **[RETURN]**.

Note

WMA

- You cannot play WMA files that are copy protected.
- WMA files must have the extension ".WMA" or ".wma".

MP3

- This unit is not compatible with ID3 tags.
- If you play an MP3 track that includes still picture data, it will take some time before the music itself starts playing and the elapsed time will not be displayed during this time. Even after the track starts, the correct play time will not be displayed.
- MP3 files must have the extension ".MP3" or ".mp3".

JPEG

- To view JPEG files on this unit:
 - Take them on a digital camera that meets the DCF (Design rule for Camera File system) standard. Some digital cameras have functions that are not supported by the DCF standard like automatic picture rotation which may render a picture un-viewable.
 - Do not alter the files in any way or save them under a different name.
 - Ensure they have the extension ".JPG", ".jpg", ".JPEG", or ".jpeg".
- This unit cannot display moving pictures, MOTION57 TD3.e.g. TIFF and/Tj0 -1.ffer ssoaiy thso

A menu appears after you insert the disc.

Press [▲, ▼, ◀, ▶] to select then press [ENTER].

When you press [ENTER]:

- Menu: Takes you to the next menu which shows play lists or another menu
- Play list: Play starts

● **To return to the menu screen**

Press [TOP MENU].

● **To return to the menu above the current one**

Press [RETURN].

● **To change the menu background**

Press [DISPLAY].

The background changes to the one recorded on the disc.

■ **Selecting from the lists**

1 While playing

Press [MENU].

	No	Content title
Playlist		
Group		
Content		
	2	Less and less
	3	And when I was born
	4	Quatre gymnopedies
		You've made me sad

2 Use [◀] then [▲, ▼] to switch between the play list, group and content lists.

3 Use [▶] then [▲, ▼] to select an item and press [ENTER].

● **To exit the list screen**

Press [MENU].

Note

Disable HighMAT disc play to use random and program play.

To use program/random play

1. In the SETUP menu, set "HighMAT" to "Disable" (⇒ page 42).
2. Reinsert the disc and perform the necessary operations (⇒ page 27).

Windows Media, and the Windows logo are trademarks, or registered trademarks of Microsoft Corporation in the United States and/or other countries.

WMA is a compression format developed by Microsoft Corporation. It achieves the same sound quality as MP3 with a file size that is smaller than that of MP3.



HighMAT and the HighMAT logo are either trademarks or registered trademarks of Microsoft Corporation in the United States and/or other countries.

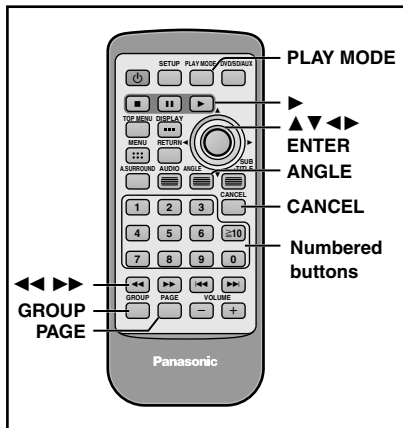

Starting play from a selected program, title, track or picture

RAM DVD-A DVD-V VCD CD WMA MP3 JPEG

Remote control only

Press the numbered buttons to select the item (WMA MP3 JPEG) and press [ENTER].

Play starts from the selected item.

To select a 2-digit number

e.g. 25: [≧10] → [2] → [5]

WMA MP3 JPEG

[2] → [5] → [ENTER]

If the on-screen menu icons are on the LCD (⇒ page 32)

- This works only when stopped with some discs.
- When playing DVD-Audio and you want to start play from a track in a different group, select the group first (⇒ right).

Selecting still pictures— Page Skip

DVD-A

During play

Press [PAGE].

The page changes each time you press the button.

Rotating pictures

JPEG

Remote control only

While a picture is displayed

- 1 Press [ANGLE].
- 2 Use [▲, ▼] to select “Rotate right” or “Rotate left” and press [ENTER].

The picture rotates ninety degrees each time you do this.

- The rotation is canceled when you open the disc lid, select another source, or switch the unit to standby.

To clear the popup screen

Press [ANGLE].

Selecting groups to play

DVD-A WMA MP3 JPEG

- 1 Press [GROUP].

e.g. MP3



Group No. | Track No. in disc
Track No. in group | Total No. of tracks on disc

- 2 Use [▲, ▼] to select the group number and press [ENTER].
- 3 Use [▲, ▼] to select the track/picture number and press [ENTER].

- You can also select the group and track/picture number with the numbered buttons.

DVD-A

- Playing all the groups in succession (⇒ page 27, All group play)
- Playing bonus groups

Some discs contain bonus groups. If a password screen appears after selecting a group, enter the password with the numbered buttons. Refer also to the disc's jacket.

Changing the play sequence

DVD-A DVD-V VCD CD WMA MP3

Remote control only

While stopped

Press [PLAY MODE].

The display changes each time you press the button.

A All group (DVD-A) → **B** Program
← OFF ← **C** Random ←

A All group play

DVD-A

The unit plays tracks in all the groups on a disc.

Press [▶] (Play).

B Program play

You can select up to 32 items to play in the order you choose.

1 DVD-A DVD-V WMA MP3

Press the numbered buttons to select a group or a title.

e.g. DVD-Video

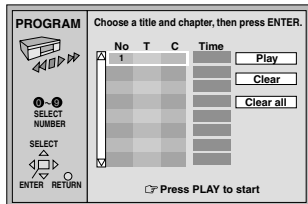

- **DVD-V** Some items cannot be selected.
- **DVD-A** If you select bonus groups, you will have to enter a 4-digit password.

2 Press the numbered buttons to select a track or a chapter (WMA MP3 and press [ENTER]).

- Repeat steps 1 and 2 to program other items.
- Times are not displayed when programming DVD-Video and WMA/MP3.

3 Press [▶] (Play).

- **DVD-V** Some items cannot be played even if you programmed them.

To add, change, or clear items

- 1 Use [**▲**, **▼**] to select the program number (No).
- 2 Do steps 1 and 2 to add or change items. Press [CANCEL] to clear an item (or use [**▲**, **▼**, **◀**, **▶**] to select "Clear" and press [ENTER]).

- Press [**◀◀**] or [**▶▶**] to change pages.

To clear the whole program

Move to "Clear all" with [**▲**, **▼**, **◀**, **▶**] and press [ENTER]. The whole program is also cleared when you open the disc lid, select another source, or switch the unit to standby.

To select an item using the cursor jockey

Press [ENTER] and [**▲**, **▼**] to select an item, then press [ENTER] again to register the number. All the items on a disc, a title or a group are selected when you select "ALL".

C Random play

1 DVD-A DVD-V

Press the numbered buttons to select a group or a title.

e.g. DVD-Video



DVD-A

- You can select more than one group. To enter all groups, select "All" using [**◀**, **▶**] and press [ENTER].
- To deselect a group, press the numbered buttons corresponding to the group you want to clear.
- If you select bonus groups, you will have to enter a 4-digit password.

2 Press [▶] (Play).

- **DVD-V** Some titles cannot be selected.

To exit the all group/program/random mode

Press [PLAY MODE] while stopped until the all group/program/random play screen disappears.

Increasing your enjoyment of movies

Marker

RAM DVD-A DVD-V VCD CD WMA MP3 JPEG

You can mark up to 5 positions to play again.

RAM: 999 positions

If places have been marked (e.g., with a DVD video recorder), they are displayed.

1 Do steps 1 to 3 on page 32 to select "Marker".



Marker

2 Press [ENTER].

RAM Use [] to select "✱".



The unit is now ready to accept markers.

3 Press [ENTER] to mark a position.

To recall a marker: [Left], [Right] → [ENTER]

To erase a marker: [Left], [Right] → [CANCEL]

To mark another position: [Left], [Right] → [ENTER]

RAM

To mark the eleventh point and beyond

1. Use [Left], [Right] to select the marker pin icon.



2. Use [Up], [Down] to select "11-20".

You can select the next group when the current group is full.

- This feature doesn't work while using a play list.
- The markers are ordered by time. This means that the marker numbers can change when you add and erase markers.
- You can clear existing markers, but they are restored when you open the disc lid, select another source or switch the unit to standby.

Note

- This feature doesn't work during program and random play.
- Markers you add clear when you open the disc lid, select another source, or switch the unit to standby.

Advanced Surround

RAM DVD-V VCD (2-channel or over only)

Enjoy a surround-like effect with 2 speakers (SP) (on other equipment) or headphones (HP). If the disc has surround effects, the effect is broadened and sound seems to come from virtual speakers on either side.

Preparation

Turn off the surround effects on the other equipment.

Press [A.SURROUND].

Each time you press the button:

e.g. SP



1 (Natural) → 2 (Emphasized) → OFF (Cancel)

To change the mode

[Left] → [Up], [Down] to select "SP" or "HP".

Optimum seating position

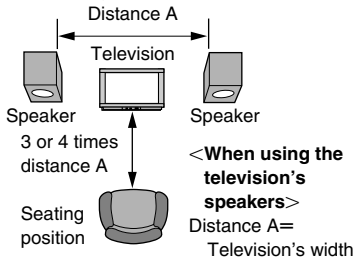

Note

- Output from this unit will be in stereo (two channels) when Advanced Surround is on.
- Turn Advanced Surround off if it causes distortion.

Changing the monitor settings

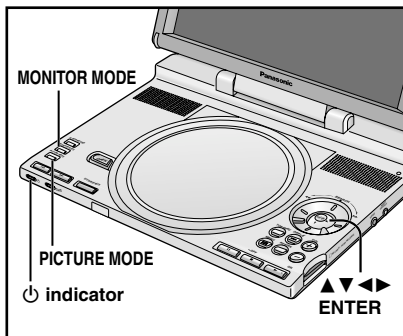

Changing the size of the picture

Select how to show 4:3-aspect pictures on the LCD.

Press [MONITOR MODE].

Each time you press the button:

NORMAL → FULL → ZOOM

↑ OFF (no picture) ← JUST ←

The picture mode and size

The picture shown on the LCD depends on the mode and the size recorded on the disc (→ below).

- If you are not using the LCD on this unit, select "OFF" to conserve power. (The [⏻] indicator flashes.)
- The LCD turns off if you close it.
- "NORMAL" is the best setting to show 16:9-aspect pictures.

Mode \ Disc	NORMAL	FULL Stretched horizontally.	ZOOM Stretched vertically and horizontally.	JUST Fills the screen for a more natural picture.
4:3				
4:3 Letterbox				

Note

These changes are effective only for this unit's LCD. Make changes to the television's settings if you have connected one.

Picture quality

1 Press [PICTURE MODE].

	-5	0	5
→ BRIGHT	-----*	-----*	-----*
COLOUR	-----*	-----*	-----*
SHARP	-----*	-----*	-----*
GAMMA	-----*	-----*	-----*
AI MODE	*ON	OFF	
BLUE LED	*ON	OFF	

2 Use [▲, ▼] to select the item.

3 Use [◀, ▶] to select the setting.

BRIGHT

Brightens the picture.

- Power consumption increases with the level of brightness.

COLOUR

Adjust the shade of the picture's color.

SHARP

Adjusts the sharpness of the edges of the horizontal lines.

GAMMA

Adjusts the brightness of dark parts of the picture.

AI MODE

Make a clear distinction between black and white.

BLUE LED

Turn the cursor jockey's light on and off.

- The cursor jockey flashes during some operations, even if you select "OFF".

■ To clear the screen

Press [PICTURE MODE].

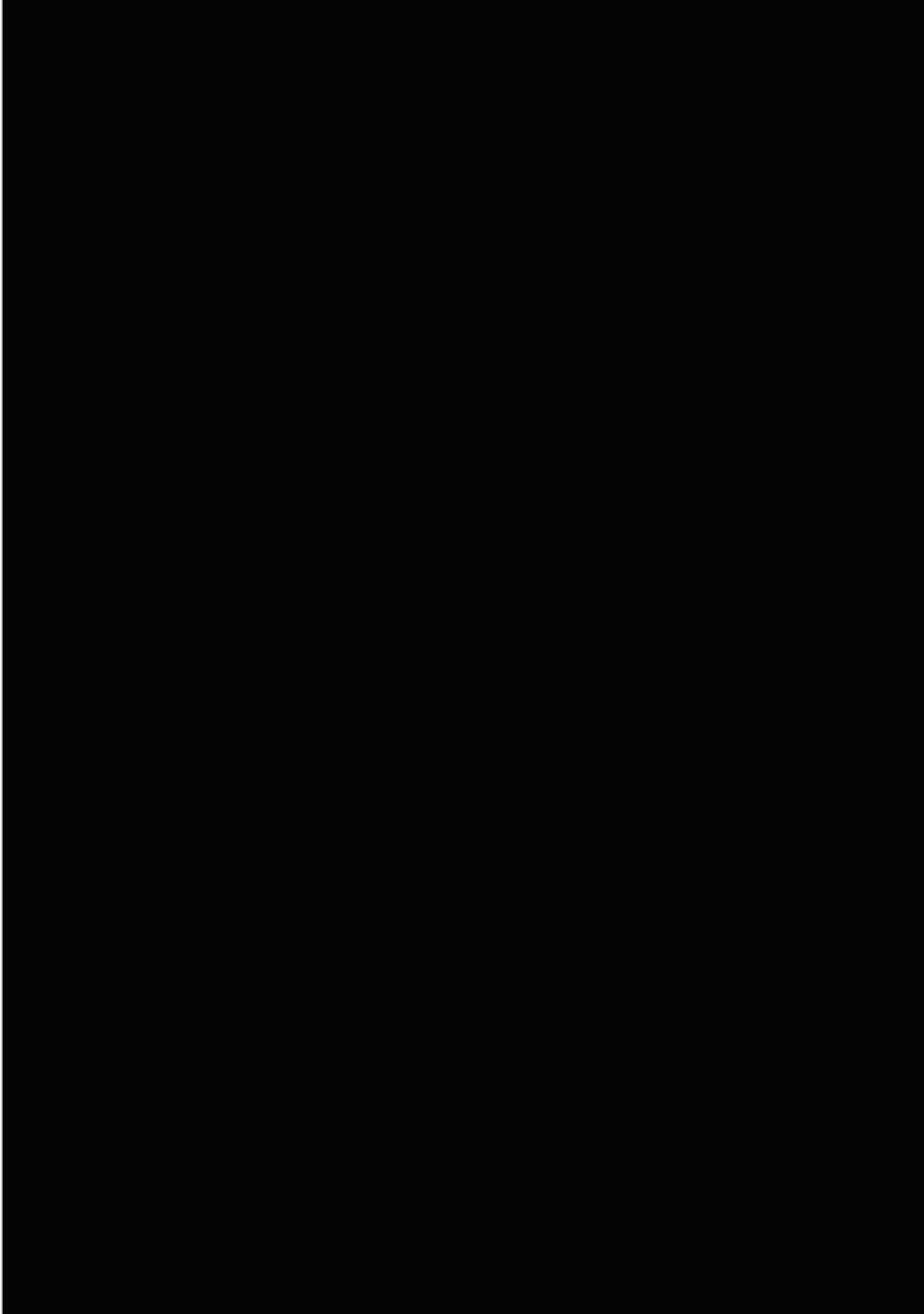

egal el itibS/oidA/A

:GE

hcnS/F

DEU:

na i lat:AT I

:PE

y a l a M: L h A M t u D: D L N

:BS

i ah i i gavr d:BN

:MD

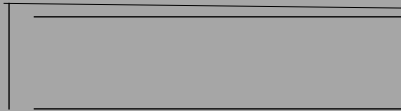

—

Unit information

Play menu



- (a) **A-B Repeat** (⇒ page 28)
- (b) **Repeat Mode** (⇒ page 28)
- (c) **Play mode display**

DVD-A **DVD-V** **VCD** **CD** **WMA** **MP3**

---: Normal play

PGM: Program play

RND: Random play

ALL: All group play (**DVD-A**)

- (d) **Marker** (⇒ page 29)

Picture menu

Display menu

Using this unit with other equipment

Enjoying more powerful sound

Enjoy the powerful movie theater and hall-like sound available with multiple channel audio found on DVDs by connecting an amplifier and speakers.

Note

- The equipment connections described are examples.
- Peripheral equipment and optional cables sold separately unless otherwise indicated.
- Before connection, turn off all equipment and read the appropriate operating instructions.

Connecting to a receiver or amplifier with 5.1 audio input terminals (Analog connection)

Change "Speaker Setting" (⇒ page 40).

- Use this connection to enjoy multi channel LPCM DVD-Audio.

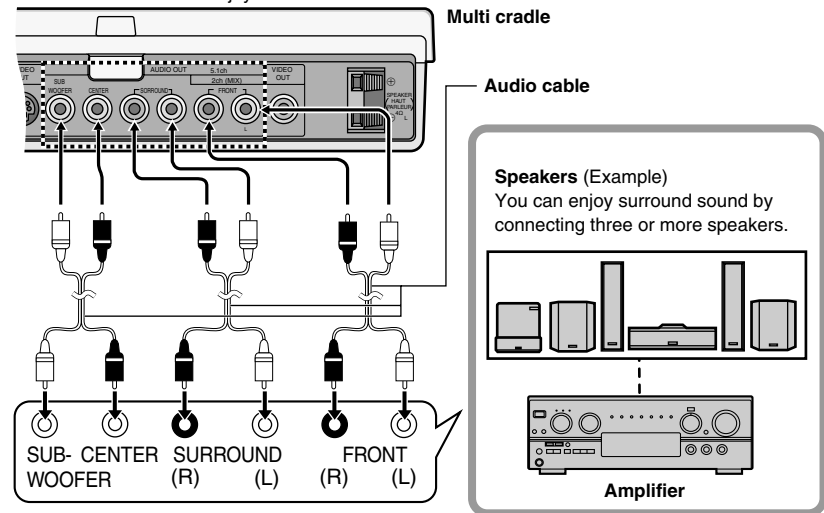

Connecting to a receiver or amplifier with built in decoders (Digital connection)

Change the settings in "Audio" (⇒ page 40).

To enjoy stereo or Dolby Pro Logic

Connect a digital amplifier or system component and change the settings in "Audio" (⇒ page 40).

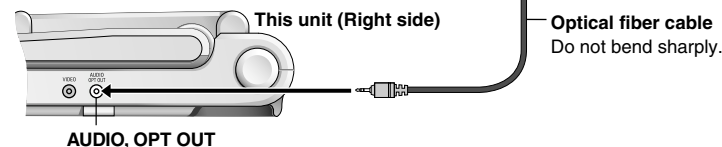

Note

- You can only use DTS Digital Surround decoders that are compatible with DVD.
- SD There is no audio output when using a digital connection.

Using this unit with a television

Before connecting, turn off all equipment and read the appropriate operating instructions.

Do not connect the player through your video cassette recorder. The picture may not be played back correctly due to the copy guard.

Connecting the multi cradle

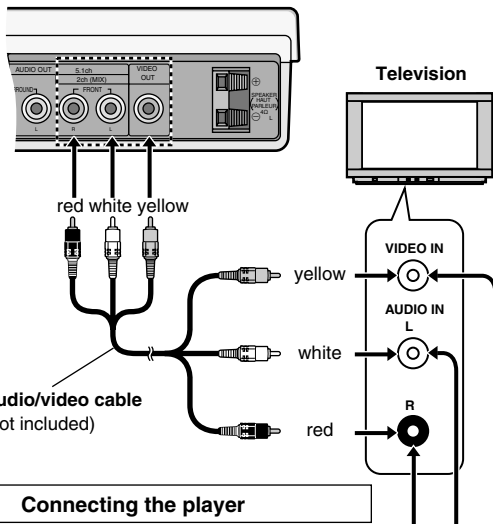

Enjoying higher picture quality

You can connect the audio cable to the 2-channel audio input terminals of an analog amplifier or system component to enjoy stereo or Dolby Pro Logic.

Connecting the player

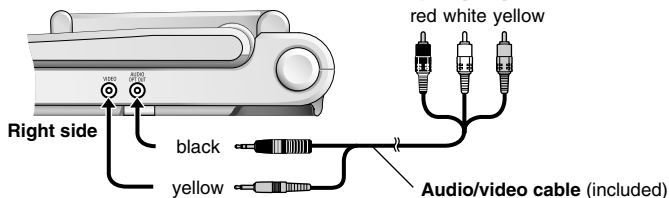

Note

- The speakers do not have magnetic shielding. Do not place near televisions, personal computers, magnetized cards (bank cards, commuter passes, etc.) or other devices easily influenced by magnetism.
- Volume may be lower when playing DVDs than when playing other discs or during TV broadcasts. If you turn the volume up, reduce it again so that a sudden increase in output does not occur.

Multi cradle

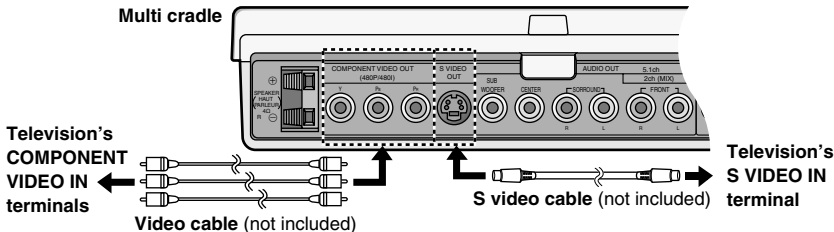

COMPONENT VIDEO OUT terminal

These terminals can be used for either interlace or progressive output and provide a purer picture than the S VIDEO OUT terminal. Connection using these terminals outputs the color difference signals (P_B/P_R) and luminance signal (Y) separately in order to achieve high fidelity in reproducing colors. The description of the component video input terminals depends on the television or monitor (e.g. Y/P_B/P_R, Y/B-Y/R-Y, Y/C_B/C_R). Connect to terminals of the same color.

- After making this connection, change the black level for a better picture (⇒ page 39, Video—Black Level Control)

S VIDEO OUT terminal

The S video terminal achieves a more vivid picture than the VIDEO OUT terminal by separating the chrominance (C) and luminance (Y) signals. (Actual results depend on the television.)

When making this connection, ensure you connect the audio cables to the corresponding audio input terminals on the television.

Note

SD There is no video output when connected with the COMPONENT VIDEO OUT terminal.

To enjoy progressive video

1. Connect to the component video input terminals on a 480P compatible television. (Video will not be displayed correctly if connected to an incompatible television.)
 2. In SETUP menu, set “Progressive Out (Component)” to “Enable” (⇒ page 39).
 3. Change “Video output mode” to “480P” (⇒ page 34).
- All televisions manufactured by Panasonic and that have 480P input connectors are compatible. Consult the manufacturer if you have another brand of television.
 - If the unit is connected to the television through VIDEO OUT or S VIDEO OUT, output will be interlace, irrespective of the settings.

Watching video from a video camera

This unit (Right side)

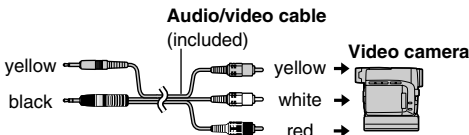

Press [DVD/SD/AUX] to select “AUX”.

Control play on the camera.

Auto standby function (⇒ page 17) does not work while the “AUX” mode is on. Turn the unit off when you have finished using it.

Using this unit with other equipment

Recording to digital recording equipment or cassette tapes

•Digital recording

You can record the digital signal directly to digital recording equipment. Connect the recording equipment with an optical fiber cable (⇒ page 35).

Note

•With DVD, the following conditions must be met: **a**) the disc doesn't have protection preventing digital recording, and **b**) the recording equipment can handle signals with a sampling frequency of 48 kHz.

•You cannot record WMA/MP3.

When recording DVDs, make the following settings.

Advanced Surround: OFF (⇒ page 29)

PCM Down Conversion: Yes (⇒ page 40)

Dolby Digital/DTS Digital Surround: PCM (⇒ page 40)

•Analog recording

You can record to a cassette deck or other recording equipment. There are no limitations on recording analog signals as there are with digital signals.

Connect the recording equipment to AUDIO, OPT OUT on the player with the audio/video cable (included) (⇒ page 36)

Or

FRONT L R [2ch (MIX)] on the multi-cradle (⇒ page 36).

[In the SETUP menu, set "Speaker Setting" to "2-channel" (⇒ page 40).]

Changing settings

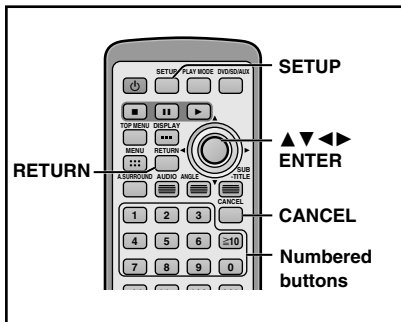

Common procedures

1 Press [SETUP] to show the menus.

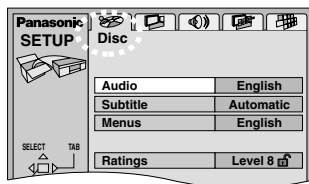

2 Press [◀, ▶] to select the menu's tab.

The screen changes to display the menu.

Disc ↔ Video ↔ Audio



Others ↔ Display



3 Press [▲, ▼] to select the item and press [ENTER].

4 Press [▲, ▼] to select the option and press [ENTER].

The screen now shows the menu again.

To return to the previous screen

Press [RETURN].

When you are finished





Press [SETUP].

For your reference



Press [MENU] on the main unit to access the SETUP menus while stopped (unless a DVD-RAM is loaded).

This chart shows the settings for this unit. Change the settings to suit your preference and to suit the unit to the environment in which it is being used. These settings are retained in memory until they are changed, even the unit is turned off.

● Underlined items are the factory presets.

Menus	Items
	<p>Audio Choose the preferred audio language. <u>English</u> French Spanish Original^{#1} Other *****^{#2}</p> <p>Subtitle Choose the preferred subtitle language. <u>Automatic</u>^{#3} English French Spanish Other *****^{#2}</p> <p>Menus Choose the preferred language for disc menus. <u>English</u> French Spanish Other *****^{#2}</p> <p>Ratings Set a ratings level to limit DVD-Video play. <u>8 No Limit</u> 1 to 7: Prohibits play of DVD-Video with corresponding ratings recorded on them. 0 Lock All</p> <p>Entering a password The password screen is shown when you select levels 0 to 7. 1. Input a 4-digit password with the numbered buttons. ● If you enter a wrong number, press [CANCEL] to erase it. 2. Press [ENTER]. ● Do not forget your password. 3. Press [ENTER] to confirm the 4 digits. ● Now, when you insert a DVD-Video that exceeds the ratings limit you set, a message appears on the screen. Follow the on-screen instructions.</p> <hr style="border-top: 1px dashed black;"/> <p>^{#1} The original language of each disc is selected. ^{#2} Input a code number with the numbered buttons (➡ page 42). ^{#3} If the language selected for "Audio" is not available, subtitles of that language will automatically appear if available on that disc.</p>
	<p>TV Aspect Choose the setting to suit your television and preference.</p> <p>4:3 Pan&Scan: Regular television (to view 16:9 software in the pan and scan style) </p> <p>4:3 Letterbox: Regular television (to view 16:9 software in the letterbox style) </p> <p><u>16:9</u>: Wide-screen television Use the television's screen modes to change the way the picture is shown.</p> <p>Progressive Out (Component) Choose "Enable" to enable progressive output. <u>Disable</u> Enable</p> <p>Still Mode Specify the type of picture shown when paused. <u>Automatic</u> Field Frame</p> <p>Black Level Control Change the black level of the picture if you connected a television through the COMPONENT VIDEO OUT terminals. <u>Lighter</u>: When connected through VIDEO OUT or S VIDEO OUT. Darker: When connected through COMPONENT VIDEO OUT (Y/P_B/P_R).</p>

Changing settings

Menus	Items
<p>Audio</p> 	<p>Speaker Setting (Analog connection) Choose the settings to suit your audio system and the listening environment. Multi-channel: when 3 or more speakers are connected (➡ right). <u>2-channel</u>: when 2 speakers or an amplifier with a Dolby Pro Logic decoder is connected.</p> <p>PCM Down Conversion (Digital connection) Select how to output audio with a sampling frequency of 96 kHz or 88.2 kHz. Select "Yes" if the equipment you connect cannot process signals with a sampling frequency of 96 kHz or 88.2 kHz. <u>No</u>: Output as 96 kHz or 88.2 kHz. Yes: Converted to 48 kHz or 44.1 kHz.</p> <ul style="list-style-type: none"> • Signals are converted to either 48 kHz or 44.1 kHz despite the above settings if the signals have a sampling frequency of over 96 kHz, or the disc has copy protection. • Some equipment cannot handle sampling frequencies of 88.2 kHz, even if they can handle 96 kHz. Read your equipment's operating instructions for details. <p>Dolby Digital (Digital connection) Select "Bitstream" if the equipment can decode the signal. <u>Bitstream</u> PCM</p> <p>DTS Digital Surround (Digital connection) Select "Bitstream" if the equipment can decode the signal. <u>PCM</u> Bitstream</p> <div style="background-color: #f0f0f0; padding: 5px; margin: 10px 0;"> <p>IMPORTANT (Dolby Digital/DTS Digital Surround) If the equipment cannot decode the signal, the setting must be changed to PCM. If not, signals the equipment cannot process will be output, causing high levels of noise which can damage your hearing and the speakers.</p> </div> <p>Dynamic Range Compression (Dolby Digital Only) Change the dynamic range for late night viewing. <u>Off</u> On</p> <p>Audio during Search* Choose whether to have sound during search. <u>On</u> Off</p> <hr style="border-top: 1px dashed black;"/> <p>* Audio will be heard when playing some DVD-Audio despite the settings you make here.</p>
<p>Display</p> 	<p>Menu Language Choose the preferred language for these menus and the on-screen messages. <u>English</u> Français Español</p> <p>On-Screen Messages Choose whether to show on-screen messages or not. <u>On</u> Off</p>

Speaker setting

You need to change settings (a), (b), and (c) when you select "Multi-channel" in "Speaker Setting" (you have connected 3 or more speakers).

- When playing DVD-Audio, the unit may not output as set here due to limitations imposed by the unit or disc.

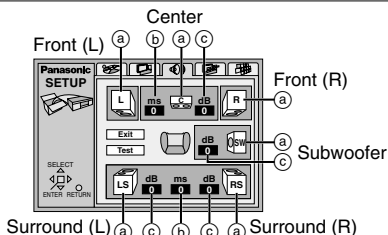

Speaker presence and size (a)

- Use [▲, ▼, ◀, ▶] to select the item and press [ENTER].
- Use [▲, ▼] to select the setting and press [ENTER].

Icon examples: Surround speaker (L)



Large



Small



No

Large: When the speaker supports low-frequency (under 100 Hz) reproduction.

Small: Select when the speaker does not support low-frequency reproduction.

The front speaker setting changes to "Large" if you change the subwoofer setting to "No". Connect front speakers that can reproduce the bass range below 100 Hz if you do not connect a subwoofer.

Delay time (b)

(Effective when playing multi-channel discs)

Place the speakers the same distance from the seating area for optimum surround sound. Change the delay time if you have to place the center or surround speakers closer to the seating area.

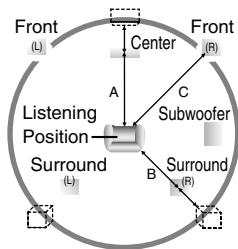

- Use [▲, ▼, ◀, ▶] to select the delay time box and press [ENTER].
- Use [▲, ▼] to adjust the delay time and press [ENTER].

Values

If distance A or B is greater than or equal to distance C, set to "0". If distance A or B is less than distance C, set as follows.

Center speaker (A)

Difference (Approx.)	Setting
50 cm (1½ feet)	1.3 ms
100 cm (3 feet)	2.6 ms
150 cm (5 feet)	3.9 ms
200 cm (6 feet)	5.3 ms

Surround speakers (B)

Difference (Approx.)	Setting
200 cm (6 feet)	5.3 ms
400 cm (12 feet)	10.6 ms
600 cm (18 feet)	15.9 ms

Channel balance (c)

- Use [▲, ▼, ◀, ▶] to select "Test" and press [ENTER].

A test signal is output from the front left speaker and proceeds clockwise.

- Use [▲, ▼] to adjust the volume of the center and surround speakers so they are the same apparent volume as the front speakers (-3 dB to +3 dB).

- The front speakers cannot be adjusted here.

- No signal is output for the subwoofer. To adjust its volume, play something, then return to this screen to adjust to suit your taste.

- Press [ENTER].

The test signal stops.

When you are finished

Use [▲, ▼, ◀, ▶] to select "Exit" and press [ENTER].

Changing settings

Menus	Items
Others 	<p>HighMAT Play HighMAT discs as HighMAT discs, or as regular WMA/MP3/JPEG discs. (Reload the disc for the setting to be effective.) Enable: Play HighMAT discs as HighMAT discs. Disable: Play HighMAT discs as regular WMA/MP3/JPEG discs.</p> <p>Mixed Disc-Audio&Stills Select the type of file played on discs containing both JPEG and WMA/MP3. (Reload the disc for the setting to be effective.) Audio (MP3/WMA) Stills (JPEG)</p> <p>DVD-Video mode Select how to play pictures contained on some DVD-Audio. The setting returns to "Off" when you remove the disc or turn the unit off. Off: DVD-Audio are played as DVD-Audio. On: You can play DVD-Video content on DVD-Audio.</p> <p>Demo A demonstration of the unit's on-screen displays starts when you select "On". The demonstration stops and the setting reverts to "Off" when you press a button (except [MONITOR MODE], [PICTURE MODE], and [OPEN]). Off On</p>

Language code list

6566: Abkhazian	7074: Fiji	7678: Lingala	8373: Singhalese
6565: Afar	7073: Finnish	7684: Lithuanian	8375: Slovak
6570: Afrikaans	7082: French	7775: Macedonian	8376: Slovenian
8381: Albanian	7089: Frisian	7771: Malagasy	8379: Somali
6577: Ameharic	7176: Galician	7783: Malay	6983: Spanish
6582: Arabic	7565: Georgian	7776: Malayalam	8385: Sundanese
7289: Armenian	6869: German	7784: Maltese	8387: Swahili
6583: Assamese	6976: Greek	7773: Maori	8386: Swedish
6588: Aymara	7576: Greenlandic	7782: Marathi	8476: Tagalog
6590: Azerbaijani	7178: Guarani	7779: Moldavian	8471: Tajik
6665: Bashkir	7185: Gujarati	7778: Mongolian	8465: Tamil
6985: Basque	7265: Hausa	7865: Nauru	8484: Tatar
6678: Bengali; Bangla	7387: Hebrew	7869: Nepali	8469: Telugu
6890: Bhutani	7273: Hindi	7879: Norwegian	8472: Thai
6672: Bihari	7285: Hungarian	7982: Oriya	6679: Tibetan
6682: Breton	7383: Icelandic	8083: Pashto, Pushto	8473: Tigrinya
6671: Bulgarian	7378: Indonesian	7065: Persian	8479: Tonga
7789: Burmese	7365: Interlingua	8076: Polish	8482: Turkish
6669: Byelorussian	7165: Irish	8084: Portuguese	8475: Turkmen
7577: Cambodian	7384: Italian	8065: Punjabi	8487: Twi
6765: Catalan	7465: Japanese	8185: Quechua	8575: Ukrainian
9072: Chinese	7487: Javanese	8277: Rhaeto-Romance	8582: Urdu
6779: Corsican	7578: Kannada	8279: Romanian	8590: Uzbek
7282: Croatian	7583: Kashmiri	8285: Russian	8673: Vietnamese
6783: Czech	7575: Kazakh	8377: Samoan	8679: Volapük
6865: Danish	7589: Kirghiz	8365: Sanskrit	6789: Welsh
7876: Dutch	7579: Korean	7168: Scots Gaelic	8779: Wolof
6978: English	7585: Kurdish	8382: Serbian	8872: Xhosa
6979: Esperanto	7679: Laotian	8372: Serbo-Croatian	7473: Yiddish
6984: Estonian	7665: Latin	8378: Shona	8979: Yoruba
7079: Faroese	7686: Latvian, Lettish	8368: Sindhi	9085: Zulu

Maintenance

■ To clean this unit, wipe with a soft, dry cloth.

- Use eyeglass cleaner to remove stubborn dirt from the LCD.
- Never use alcohol, paint thinner or benzine to clean this unit.

■ Maintenance of the lens

- Remove dust carefully with an air blower for camera lenses (optional).
Recommended product:
Lens cleaner kit (SZZP1038C)
(Available from Panasonic dealers.)
- Be careful not to touch the lens with your fingers.

Troubleshooting Guide

Before requesting service, make the following checks. If you are in doubt about some of the check points, or if the remedies indicated in the chart do not solve the problem:

In the U.S.A., contact the Panasonic Customer Call Center at 1-800-211-7262, or e-mail consumerproducts@panasonic.com, or the website (<http://www.panasonic.com>). In Canada, contact the Panasonic Canada Inc. Customer Care Centre at 1-800-561-5505, or visit the website (www.panasonic.ca), or an authorized Servicentre closest to you.

Reference pages are shown as black circled numbers 12.

Power

No power.	<ul style="list-style-type: none"> ● Check connections to the AC adaptor or battery pack. 12 14 ● You cannot turn on the unit with the remote control if the unit is powered by the battery pack.
Unit turns off automatically. Unit doesn't work when powered by battery.	<ul style="list-style-type: none"> ● The unit turns off after it has been stopped for about 15 minutes (5 minutes when the unit is powered by the battery pack) to conserve power. Turn the unit on again. ● The unit and battery pack have protection circuitry that activate if they become too hot or too cold. They will not work if this occurs. Use the unit and battery pack between 5 °C (41 °F) and 35 °C (95 °F).
Cannot charge or the [CHG] indicator fails to light.	<ul style="list-style-type: none"> ● The battery pack can only be recharged when the unit is off. ● The charging time increases when the temperature is too hot or too cold, and charging may not be possible under some circumstances. ● Check connection to the AC adaptor. 12
Play time dramatically reduces after recharging.	<ul style="list-style-type: none"> ● The battery pack has reached the end of its service life (it can be recharged about 300 times).

Operation

No response when buttons are pressed.	<ul style="list-style-type: none"> ● Some discs prohibit certain operations. ● If there is no response at all, the unit may have been affected by lightning or static electricity. Try turning the unit off and on again. Alternatively, turn the unit off, disconnect the power source (AC or battery pack) reconnect the power and turn the unit on again.
Play fails to start or stops soon after starting.	<ul style="list-style-type: none"> ● Condensation may have formed in the unit. Wait 1 or 2 hours for it to clear. ● This unit cannot play discs other than those specified. 8 ● Clean the disc. 9 ● Ensure the disc is inserted correctly. 16 ● Check that the disc has something recorded on it.
The file recorded on SD is not displayed.	<ul style="list-style-type: none"> ● Some files are not compatible with this unit and cannot be played back. For example: <ul style="list-style-type: none"> – Moving picture files recorded using a digital still camera with moving picture function – IC recorder voice files etc
No operation with remote control.	<ul style="list-style-type: none"> ● Check that the battery is inserted correctly. 15 ● Replace the battery if it is drained. 15 ● Aim the remote control at the remote control signal sensor. 15
The audio soundtrack or subtitle language cannot be changed.	<ul style="list-style-type: none"> ● This function is dependent on software availability. ● Some DVDs require you to change the languages through menus.
Subtitles not shown.	<ul style="list-style-type: none"> ● This function is dependent on software availability. ● Turn the subtitles on. 20 ● Subtitle position is wrong. Adjust the position. 20
Angles cannot be changed.	<ul style="list-style-type: none"> ● This function is dependent on software availability. There may be parts of multi-angle DVDs where different angles are not recorded.
You have forgotten your ratings password. You want to reset the unit to the factory settings.	<ul style="list-style-type: none"> ● Do the following to reset the unit to its original factory settings (SD settings are unaffected). While the unit is stopped, press and hold [II], [◀◀] (backward), and [▶, ON] on the main unit for about 3 seconds until the message "Initialized" disappears from the display, then turn the unit off.

Operation

The unit doesn't play the data type (WMA/MP3 or JPEG) selected in the "Mixed Disc-Audio&Stills" in the SETUP menu.	Reload the disc for the setting to be effective. Open and close the disc lid, then press [▶] (Play) to start play.
--	--



Sound

There is a lot of noise.	<ul style="list-style-type: none"> ● Move unit away from mobile phones.
No sound from the unit's speaker.	<ul style="list-style-type: none"> ● The speaker is off if the LCD is closed or headphones are connected. ● Turn up the volume. 16
No sound from other speakers. Distorted sound.	<ul style="list-style-type: none"> ● Check all connections and settings. 35–37, 40, 41 ● Check input mode of the other equipment. ● Advanced Surround may cause distortion with some discs. Turn Advanced Surround off if this occurs. 29 ● Output from this unit will be in stereo (two channels) when Advanced Surround is on. Turn Advanced Surround off if you are using three or more speakers. 29 ● Some DVD-Audio specify the number of channels to be played and prohibit down-mixing to 2 channels. Read the disc's instructions for details. ● Press [▶] (Play) to restore normal play after changing the speed. 32 ● Noise may occur when playing WMA files. ● [SD] There may be some noise output when playing MPEG4 and VOICE files, but this is normal.
Sound effects do not work.	<ul style="list-style-type: none"> ● Dialogue Enhancer and Advanced Surround do not work when the unit is outputting bitstream signals. ● Advanced Surround does not work if you have changed the play speed. 32

Picture

The LCD is dark.	<ul style="list-style-type: none"> ● Adjust the brightness. 31
Picture distorted.	<ul style="list-style-type: none"> ● Some disruption is normal during SEARCH. ● [SD] Picture quality may worsen or some frames may be skipped when viewing MPEG4, but this is normal.
Menus not displayed correctly.	<ul style="list-style-type: none"> ● Restore the zoom ratio to $\times 1.00$. 34 ● Set the subtitle position to 0. 30 ● Set "4:3 Aspect" to "Normal". 34
No picture on the LCD	<ul style="list-style-type: none"> ● Select a picture mode other than "OFF" (no picture). 31
Picture from another unit not shown on the LCD.	<ul style="list-style-type: none"> ● Check connections. 37 ● Ensure the input setting is correct. 37 ● Ensure the power of the connected equipment is on.
Picture doesn't appear on the television (or the size of the picture seems wrong).	<ul style="list-style-type: none"> ● Check connections. 36, 37 ● Check that the television is on. ● Check that the input mode on the television is correct. ● Check the settings in "Video—TV Aspect". 39 ● Use the television to change the aspect to the correct one. If your television cannot change the aspect when input is progressive, try changing 4:3 Aspect with the on-screen menu icons. 34 ● Turn off the zooming feature of your television if you are using Variable Zoom. 34 ● Ensure that the unit is connected directly to the television, and is not connected through a video cassette recorder. 36
There is ghosting when progressive output is on.	<ul style="list-style-type: none"> ● Change "Video output mode" to "480i". This problem is caused by the editing method or material used on DVD-Video, but should be corrected if you use interlace output. 34
LCD pixels turn black or radiate different colors.	<ul style="list-style-type: none"> ● The LCD is constructed with precision technology so 99.99 % of the pixels are active, but of the remaining of 0.01 %, there are pixels that may be black or emit light constantly. This phenomenon is not a malfunction.

Displays

On-Screen Menu Icons are cut off.	● Use [▲, ▼] while the Bar position icon is highlighted to move them down. 32
No On-Screen display.	● Go to the Display menu in the SETUP screen, and select "On" for "On-Screen Messages". 40
"Check the disc."	● Clean the disc. 9
"The progressive out is set to "Disable""	● Go to Video in the SETUP menus, and select "Enable" in "Progressive Out (Component)". 69
"X"	● You are trying to play incompatible or corrupted data. This data cannot be played.
"CHECK CARD"	● The card cannot be played.
"NO FILE"	● Data the unit can play is not recorded on the card.
"PLEASE RE-OPERATE"	● Turn the unit off and on again. Alternatively, turn the unit off, disconnect the power source (AC or battery pack) reconnect the power and turn the unit on again.
"  ERROR 01"	● A problem has occurred with the battery pack. Consult your dealer.
"  ERROR 02"	● The battery pack has been recharging for 12 hours but has failed to recharge for some reason. Recharge again.
"  ERROR 03"	● You are recharging in a location that is too hot or too cold. Recharge at normal temperature.
"H <input type="checkbox"/> <input type="checkbox"/> <input type="checkbox"/> <input type="checkbox"/> stands for a number. "U11"	● Trouble has occurred. The number appearing after H depends on the problem. Turn the unit off and on again. Alternatively, turn the unit off, disconnect the power source (AC or battery pack) reconnect the power and turn the unit on again. If the service numbers fail to clear, note the service number and contact a qualified service person.

[⏻] and [CHG] indicators

The [⏻] indicator flashes rapidly.	● The unit has malfunctioned. Consult your dealer.
The [⏻] indicator flashes slowly.	● The unit is on and the LCD is closed or the display mode is set to "OFF" (no picture). Turn the unit off when you have finished.
The [CHG] indicator flashes rapidly.	● There is a problem with the battery pack. Turn the unit on and check the message on the LCD (see above).
The [CHG] indicator flashes slowly.	● Battery pack charge is low. The unit will turn off automatically after a few minutes. 10

Note

The following do not indicate malfunction.

- Sound from the AC adaptor during recharging.
- The battery pack warming up when recharging or during use.
- The surface and area around the card slot becoming warm when used over long periods.

Glossary

Bitstream

The digital form of multi-channel data (e.g., 5.1 channel) before decoding.

Decoder

A decoder restores the coded audio signals on DVDs to normal. This is called decoding.

Dolby Digital

This is a method of coding digital signals developed by Dolby Laboratories. Apart from stereo (2-channel) audio, these signals can also be multi-channel audio. A large amount of audio information can be recorded on the disc using this method.

Dolby Pro Logic

A surround system where a 4-channel audio track is recorded as 2 channels and then is restored to 4 channels for play. The surround channel is monaural and can reproduce up to 7 kHz.

DTS (Digital Theater Systems)

This surround system is used in many movie theaters around the world. There is good separation between the channels, so realistic sound effects are possible.

Dynamic range

Dynamic range is the difference between the lowest level of sound that can be heard above the noise of the equipment and the highest level of sound before distortion occurs.

Film and video

DVD-Videos are recorded using either film or video. Usually, film is recorded at 24 frames per second, the rate movies are filmed at, while video is recorded at 30 frames per second.

Frame still and field still

Frames are the still pictures that make moving pictures. About thirty are shown each second. A frame still may appear blurred but overall quality is high.

Two fields appear alternately to make up one frame. A field still is not blurred but picture quality is lower.

Interlace and progressive output

NTSC, the video signal standard, has 480 interlaced (I) scan lines, whereas progressive scanning uses twice the number of scan lines. This is called 480P.

I/P/B

MPEG 2, the video compression standard adopted for use with DVD-Video, codes frames using these 3 picture types.

I: Intra coded picture

This picture has the best quality and is the best to use when adjusting the picture.

P: Predictive coded picture

This picture is calculated based on past I or P-pictures.

B: Bidirectionally-predictive coded picture

This picture is calculated by comparing past and future I and P-pictures so it has the lowest volume of information.

Linear PCM (pulse code modulation)

These are uncompressed digital signals, similar to those found on CDs.

Playback control (PBC)

If a Video CD has playback control, you can select scenes and information with menus.

Product Service

Reference

- 1. Damage requiring service**—The unit should be serviced by qualified service personnel if:
 - (a) The AC power supply cord or AC adaptor has been damaged; or
 - (b) Objects or liquids have gotten into the unit; or
 - (c) The unit has been exposed to rain; or
 - (d) The unit does not operate normally or exhibits a marked change in performance; or
 - (e) The unit has been dropped or the cabinet damaged.
- 2. Servicing**—Do not attempt to service the unit beyond that described in these operating instructions. Refer all other servicing to authorized servicing personnel.
- 3. Replacement parts**—When parts need replacing ensure the servicer uses parts specified by the manufacturer or parts that have the same characteristics as the original parts. Unauthorized substitutes may result in fire, electric shock, or other hazards.
- 4. Safety check**—After repairs or service, ask the servicer to perform safety checks to confirm that the unit is in proper working condition.

Product information

For product information or assistance with product operation:

In the U.S.A., contact the Panasonic Customer Call Center at 1-800-211-7262, or e-mail consumerproducts@panasonic.com, or the website (<http://www.panasonic.com>).
In Canada, contact the Panasonic Canada Inc. Customer Care Centre at 1-800-561-5505, or visit the website (www.panasonic.ca), or an authorized Servicentre closest to you.

Specifications

■ Main unit

Discs played: DVD-RAM (DVD-VR format)
DVD-Video, DVD-Audio
Music CD [CD-DA (CD-TEXT compatible)]
Video CD
CD-R/CD-RW [CD-DA (CD-TEXT compatible),
Video CD, MP3, WMA, JPEG,
HighMAT Level 2 (Audio and Image)]
DVD-R (finalized as DVD-Video)

SD played:

Media: SD Memory Card
Image: JPEG
Video: MPEG4
Voice: G.726
Audio: MPEG2-AAC, MP3
(Sampling frequency:
32 kHz, 44.1 kHz, 48 kHz)

Signal system: NTSC

LCD screen: 9" α -Si, TFT wide-screen LCD
(VGA 800×480×RGB pixels)

Composite-video output/input:

Output/input level: 1 Vp-p (75 Ω)
Output/input terminal: Mini-jack
Number of terminals: 1 system (output/input)

Audio output/input:

Output/input level: 1.5 Vrms
(1 kHz, 0 dB, 10 k Ω)
Output/input terminal: Stereo mini-jack
Number of terminals: 1 system (output/input)

Audio performance:

- Frequency response:
 - DVD (linear audio):
4 Hz–22 kHz (48 kHz sampling)
4 Hz–44 kHz (96 kHz sampling)
 - DVD-Audio:
4 Hz–88 kHz (192 kHz sampling)
 - CD audio: 4 Hz–20 kHz
- S/N:
 - CD audio: 115 dB
- Dynamic range:
 - DVD (linear audio): 98 dB
 - CD audio: 97 dB
- Total harmonic distortion:
 - CD audio: 0.008 %

Digital audio output:

Output terminal: Mini optical terminal
Number of terminals: 1 system
(also used for audio output/input)

Built-in speakers: 1 W+1 W stereo output

Pickup:

Wave length: 658 nm/790 nm
Laser power: CLASS II/CLASS I

Power supply: DC 9 V (DC IN terminal)/
DC 7.2 V (Battery terminal)

Power consumption

(using included AC adaptor):
17 W (Unit only: 13 W)
Recharging 13 W

Battery pack CGR-H604 (lithium ion):

Voltage: 7.2 V
Capacity: 3000 mAh

Dimensions (excluding protrusions):

232 (W)×173.5 (D)×30.7* (H) mm
[9⁷/₁₆" (W)×6²⁷/₃₂" (D)×1¹/₃₂" (H)]
*24.6 mm (³¹/₃₂" at lowest point)
1200 g (42.3 oz.)

Mass:

■ Multi cradle

Composite-video output:

Output level: 1 Vp-p (75 Ω)
Output terminal: RCA pin-jack
Number of terminals: 1 system

S-video output:

Y output level: 1 Vp-p (75 Ω)
C output level: 0.286 Vp-p (75 Ω)
Output terminal: S-video jack
Number of terminals: 1 system

Component-video output

(Progressive compatible):
Y output level: 1 Vp-p (75 Ω)
P_B output level: 0.525 Vp-p (75 Ω)
P_R output level: 0.525 Vp-p (75 Ω)
Output terminal: RCA pin-jack
Number of terminals: 1 system

Audio output:

Output level: 1.5 Vrms (1 kHz, 0 dB, 10 k Ω)
Output terminal: RCA pin-jack
Number of terminals: 5.1 ch discreet output
1 system

Included speakers: 2 W+2 W stereo output

Power supply: DC 9 V (DC IN terminal)

Power consumption

(using included AC adaptor):
27 W (when connected
to main unit and playing)

Dimensions (excluding protrusions):

238 (W)×182 (D)×38 (H) mm
[9⁹/₁₆" (W)×7³/₁₆" (D)×1¹/₂" (H)]

Mass: 680 g (24.0 oz)

■ Common

Operating temperature range:

+5 to +35 °C (+41 to +95 °F)

Operating humidity range:

10–80 % RH (no condensation)

AC adaptor:

Power source: AC 100–240 V, 50/60 Hz

Power consumption: 38 W

DC output: 9 V, 2500 mA

Note

Specifications are subject to change without notice.

Mass and dimensions are approximate.

Power consumption in standby mode
(using included AC adaptor):

Main unit: 0.8 W

Multi cradle: 0.9 W (when connected
to main unit)

Limited Warranty (ONLY FOR U.S.A.)

Panasonic Consumer Electronics Company, Division of Matsushita Electric Corporation of America

One Panasonic Way Secaucus, New Jersey
07094

Panasonic Sales Company, Division of Matsushita Electric of Puerto Rico, Inc.

Ave. 65 de Infantería, Km. 9.5
San Gabriel Industrial Park, Carolina, Puerto
Rico 00985

Panasonic DVD Player/Recorder Limited Warranty

Limited Warranty Coverage

If your product does not work properly because of a defect in materials or workmanship, Panasonic Consumer Electronics Company or Panasonic Sales Company (collectively referred to as "the warrantor") will, for the length of the period indicated on the chart below, which starts with the date of original purchase ("warranty period"), at its option either (a) repair your product with new or refurbished parts, or (b) replace it with a new or a refurbished product. The decision to repair or replace will be made by the warrantor.

Product or Part Name	Parts	Labor
DVD Player	One (1) Year	Ninety (90) Days
DVD Recorder	One (1) Year	One (1) Year
Rechargeable Batteries, DVD-RAM Disc (in exchange for defective item)	Ten (10) Days	Not Applicable

During the "Labor" warranty period there will be no charge for labor. During the "Parts" warranty period, there will be no charge for parts. You must carry-in or mail-in your product during the warranty period. If non-rechargeable batteries are included, they are not warranted. This warranty only applies to products purchased and serviced in the United States or Puerto Rico. This warranty is extended only to the original purchaser of a new product which was not sold "as is". A purchase receipt or other proof of the original purchase date is required for warranty service.

Carry-In or Mail-In Service

For Carry-In or Mail-In Service in the United States call 1-800-211-PANA (7262) or visit Panasonic Web Site: <http://www.panasonic.com>
For assistance in Puerto Rico call Panasonic Sales Company (787)-750-4300 or fax (787)-768-2910.

Limited Warranty Limits And Exclusions

This warranty ONLY COVERS failures due to defects in materials or workmanship, and DOES NOT COVER normal wear and tear or cosmetic damage. The warrantor ALSO DOES NOT COVER damages which occurred in shipment, or failures which are caused by products not supplied by the warrantor, or failures which result from accidents, misuse, abuse, neglect, mishandling, misapplication, alteration, faulty installation, set-up adjustments, misadjustment of consumer controls, improper maintenance, power line surge, lightning damage, modification, or commercial use (such as in a hotel, office, restaurant, or other business), rental use of the product, service by anyone other than a Factory Servicenter or other Authorized Servicer, or damage that is attributable to acts of God.

THESE ARE NO EXPRESS WARRANTIES EXCEPT AS LISTED UNDER "LIMITED WARRANTY COVERAGE". THE WARRANTOR IS NOT LIABLE FOR INCIDENTAL OR CONSEQUENTIAL DAMAGES RESULTING FROM THE USE OF THIS PRODUCT, OR ARISING OUT OF ANY BREACH OF THIS WARRANTY. (As examples, this excludes damages for lost time, travel to and from the servicer, loss of media or images, data or other recorded content. The items listed are not exclusive, but are for illustration only.) **ALL EXPRESS AND IMPLIED WARRANTIES, INCLUDING THE WARRANTY OF MERCHANTABILITY, ARE LIMITED TO THE PERIOD OF THE LIMITED WARRANTY.**

Some states do not allow the exclusion or limitation of incidental or consequential damages, or limitations on how long an implied warranty lasts, so the exclusions may not apply to you.

This warranty gives you specific legal rights and you may also have other rights which vary from state to state. If a problem with this product develops during or after the warranty period, you may contact your dealer or Servicenter. If the problem is not handled to your satisfaction, then write to the warrantor's Consumer Affairs Department at the addresses listed for the warrantor.

PARTS AND SERVICE WHICH ARE NOT COVERED BY THIS LIMITED WARRANTY ARE YOUR RESPONSIBILITY.

Customer Services Directory

For Product Information, Operating Assistance, Literature Request, Dealer Locations, and all Customer Service inquiries please contact:
1-800-211-PANA (7262), Monday–Friday 9 am–9 pm;
Saturday–Sunday 9 am–7 pm, EST.
or send e-mail:
consumerproducts@panasonic.com
For hearing or speech impaired TTY users, TTY: 1-877-833-8855

*Web Site: <http://www.panasonic.com>
You can purchase parts, accessories or locate your nearest servicenter by visiting our Web Site.*

Accessory Purchases:

1-800-332-5368 (Customer Orders Only)

For hearing or speech impaired TTY users, TTY: 1-866-605-1277

Panasonic Services Company 20421 84th Avenue South, Kent, WA 98032

(6 am to 5 pm Monday–Friday; 6 am to 10:30 am Saturday; PST)

(Visa, MasterCard, Discover Card, American Express, Check)

Service in Puerto Rico

*Matsushita Electric of Puerto Rico, Inc. Panasonic Sales Company/Factory Servicenter:
Ave. 65 de Infantería, Km. 9.5, San Gabriel Industrial Park, Carolina, Puerto Rico 00985
Phone (787) 750-4300 Fax (787) 768-2910*

Panasonic Consumer Electronics Company,
Division of Matsushita Electric Corporation of America
One Panasonic Way Secaucus, New Jersey 07094
<http://www.panasonic.com>

Panasonic Sales Company, Division of Matsushita Electric of Puerto Rico, Inc. ("PSC")
Ave. 65 de Infantería, Km. 9.5 San Gabriel Industrial Park, Carolina, Puerto Rico 00985

Panasonic Canada Inc.
5770 Ambler Drive, Mississauga, Ontario L4W 2T3
www.panasonic.ca

© 2003 Matsushita Electric Industrial Co., Ltd.

Printed in Japan