

DV-S501

DVD Player Instruction Manual

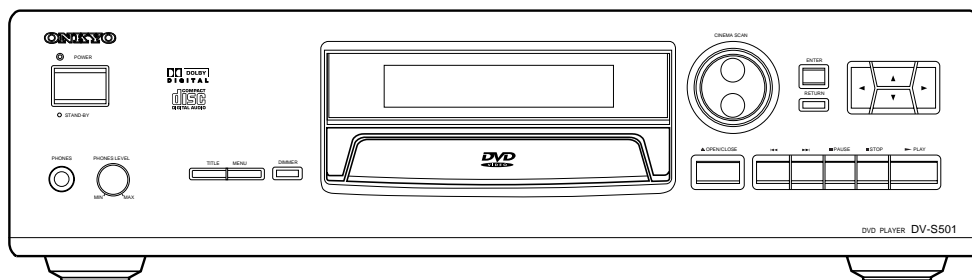

THIS DVD PLAYER IS MANUFACTURED FOR PLAYBACK OF REGION 1 (USA, CANADA) ENCODED DVD SOFTWARE. USE OF SOFTWARE NOT INTENDED FOR REGION 1 PLAYBACK MAY RESULT IN UNDESIRABLE PLAYER PERFORMANCE.

Safety Precautions

Thank you for your purchase of the Onkyo DVD player.

Please read this manual thoroughly before making connections and turning on the power.

Following the instructions in this manual will enable you to obtain optimum performance and listening enjoyment from your new DVD player.

Please retain this manual for future reference.

“WARNING”

“TO REDUCE THE RISK OF FIRE OR ELECTRIC SHOCK, DO NOT EXPOSE THIS APPLIANCE TO RAIN OR MOISTURE.”

CAUTION:

“TO REDUCE THE RISK OF ELECTRIC SHOCK, DO NOT REMOVE COVER (OR BACK). NO USER-SERVICEABLE PARTS INSIDE. REFER SERVICING TO QUALIFIED SERVICE PERSONNEL.”



The lightning flash with arrowhead symbol, within an equilateral triangle, is intended to alert the user to the presence of uninsulated “dangerous voltage” within the product’s enclosure that may be of sufficient magnitude to constitute a risk of electric shock to persons.



The exclamation point within an equilateral triangle is intended to alert the user to the presence of important operating and maintenance (servicing) instructions in the literature accompanying the product.



WARNING: TO REDUCE THE RISK OF FIRE OR ELECTRIC SHOCK, DO NOT EXPOSE THIS APPLIANCE TO RAIN OR MOISTURE. DANGEROUS HIGH VOLTAGES ARE PRESENT INSIDE THE ENCLOSURE. DO NOT OPEN THE CABINET. REFER SERVICING TO QUALIFIED PERSONNEL ONLY.

**FOR CANADIAN MODEL:
POUR LE MODELE CANADIE**

For models having a power cord with a polarized plug.

CAUTION: TO PREVENT ELECTRIC SHOCK, MATCH WIDE BLADE OF PLUG TO WIDE SLOT, FULLY INSERT.

- THIS DIGITAL APPARATUS DOES NOT EXCEED THE CLASS B LIMITS FOR RADIO NOISE EMISSION FROM DIGITAL APPARATUS SET OUT IN THE RADIO INTERFERENCE REGULATIONS OF THE CANADIAN DEPARTMENT OF COMMUNICATIONS.

Sur les modèles dont la fiche est polarisée.

ATTENTION: POUR ÉVITER LES CHOCS ÉLECTRIQUES, INTRODUIRE LA LAME LA PLUS LARGE DE LA FICHE DANS LA BORNE CORRESPONDANTE DE LA PRISE ET POUSSER JUSQU’AU FOND.

- L’INTERFERENCE, RADIO ELECTRIQUE GENEREES PAR CET APPAREIL NUMERIQUE DE TYPE B NE DEPASSE PAS LES LIMITE ENONCEES DANS LE REGLEMENT SUL LES PERTURBATIONS RADIO ELECTRIQUES, SECTION APPAREIL NUMERIQUE, DU MINISTERE DES COMMUNICATIONS.

DANGER:

INVISIBLE LASER RADIATION WHEN OPEN AND INTERLOCK FAILED OR DEFEATED. AVOID DIRECT EXPOSURE TO BEAM.

CAUTION:

THIS PRODUCT UTILIZES A LASER. USE OF CONTROLS OR ADJUSTMENTS OR PERFORMANCE OF PROCEDURES OTHER THAN THOSE SPECIFIED HEREIN MAY RESULT IN HAZARDOUS RADIATION EXPOSURE.

FOR U.S.A. MODEL:

1. This laser is covered by a housing which prevents exposure during operation or maintenance. However, this product is classified as a Laser Product by CDRH (Center for Devices and Radiological Health) which is a department of the Food and Drug Administration. According to their regulations 21 CFR section 1002.30, all manufacturers who sell Laser Products must maintain records of written communications between the manufacturer, dealers and customers concerning radiation safety. If you have any complaints about instructions or explanations affecting the use of this product, please feel free to write to the address on the back page of this manual. When you write us, please include the model number and serial number of your DVD player.
2. In compliance with Federal Regulations, the certification, identification and the period of manufacture are indicated on the rear panel.

3. FCC INFORMATION FOR USER**CAUTION:**

Changes or modifications not expressly approved by the party responsible for compliance could void the user's authority to operate the equipment.

NOTE:

This equipment has been tested and found to comply with the limits for a Class B digital device pursuant to Part 15 of the FCC Rules. These limits are designed to provide reasonable protection against harmful interference in a residential installation. This equipment generates, uses, and can radiate radio frequency energy and, if not installed and used in accordance with the instructions, may cause harmful interference to radio communications. However, there is no guarantee that interference will not occur in a particular installation. If this equipment does cause harmful interference to radio or television reception which can be determined by turning the equipment off and on, the user is encouraged to try to correct the interference by one or more of the following measures:

- Reorient or relocate the receiving antenna.
- Increase the separation between the equipment and receiver.
- Connect the equipment into an outlet on a circuit different from that to which the receiver is connected.
- Consult the dealer or an experienced radio/TV technician for help.

WARNING: Changes or modifications made to this equipment, not expressly approved by Onkyo, or parties authorized by Onkyo, could void the user's warranty of the equipment.



**"CLASS 1 LASER
PRODUCT"**

This label on the rear panel of the unit states that:

1. This unit is a CLASS 1 LASER PRODUCT and employs a laser inside the cabinet.
2. To prevent the laser from being exposed, do not remove the cover. Refer servicing to qualified personnel.

FOR CANADIAN MODEL:

(POUR LE MODELE CANADIEN)

- THIS DIGITAL APPARATUS DOES NOT EXCEED THE CLASS B LIMITS FOR RADIO NOISE EMISSION FROM DIGITAL APPARATUS SET OUT IN THE RADIO INTERFERENCE REGULATIONS OF THE CANADIAN DEPARTMENT OF COMMUNICATIONS.
- L'INTERFERENCE, RADIO ELECTRIQUE GENEREE PAR CET APPAREIL NUMERIQUE DE TYPE B NE DEPASSE PAS LES LIMITES ENONCEES DANS LE REGLEMENT SUL LES PERTURBATIONS RADIO ELECTRIQUES, SECTION APPAREIL NUMERIQUE, DU MINISTERE DES COMMUNICATIONS.

Important Safeguards

1. **Read Instructions** – All the safety and operating instructions should be read before the appliance is operated.
2. **Retain Instructions** – The safety and operating instructions should be retained for future reference.
3. **Heed Warnings** – All warnings on the appliance and in the operating instructions should be adhered to.
4. **Follow Instructions** – All operating and use instructions should be followed.
5. **Water and Moisture** – The appliance should not be used near water – for example, near a bathtub, washbowl, kitchen sink, laundry tub, in a wet basement, or near a swimming pool, and the like.
6. **Carts and Stands** – The appliance should be used only with a cart or stand that is recommended by the manufacturer.
 - 6A. An appliance and cart combination should be moved with care. Quick stops, excessive force, and uneven surfaces may cause the appliance and cart combination to overturn.
7. **Wall or Ceiling Mounting** – The appliance should be mounted to a wall or ceiling only as recommended by the manufacturer.
8. **Ventilation** – The appliance should be situated so that its location or position does not interfere with its proper ventilation. For example, the appliance should not be situated on a bed, sofa, rug, or similar surface that may block the ventilation openings; or if placed in a built-in installation, such as a book case or cabinet that may impede the flow of air through the ventilation openings, there should be free space of at least 5 cm (2 in.) and open up behind the appliance.
9. **Heat** – The appliance should be situated away from heat sources such as radiators, heat registers, stoves, or other appliances (including amplifiers) that produce heat.
10. **Power Sources** – The appliance should be connected to a power supply only of the type described in the operating instructions or as marked on the appliance.
11. **Polarization** – If the appliance is provided with a polarized plug having one blade wider than the other, please read the following information: The polarization of the plug is a safety feature. The polarized plug will only fit the outlet one way. If the plug does not fit fully into the outlet, try reversing it. If there is still trouble, the user should seek the services of a qualified electrician. Under no circumstances should the user attempt to defeat the polarization of the plug.
12. **Power- Cord Protection** – Power-supply cords should be routed so that they are not likely to be walked on or pinched by items placed upon or against them, especially wear plugs, convenience receptacles, and the point where they exit from the appliance.
13. **Cleaning** – The appliance should be cleaned only as recommended by the manufacturer.
14. **Nonuse Periods** – The power cord of the appliance should be unplugged from the outlet when left unused for a long period of time.
15. **Object and Liquid Entry** – Care should be taken so that objects do not fall and liquids are not spilled into the enclosure through openings.
16. **Damage Requiring Service** – The appliance should be serviced by qualified service personnel when:
 - A. The power-supply cord or the plug has been damaged; or
 - B. Objects have fallen, or liquid has been spilled into the appliance; or
 - C. The appliance has been exposed to rain; or
 - D. The appliance does not appear to operate normally or exhibits a marked change in performance; or
 - E. The appliance has been dropped, or the enclosure damaged.
17. **Servicing** – The user should not attempt to service the appliance beyond that described in the operating instructions. All other servicing should be referred to qualified service personnel.

PORTABLE CART WARNING



S3125A

Precautions

Notes on Handling

- When shipping the DVD player, the original shipping carton and packing materials come in handy. For maximum protection, repack the unit as it was originally packed at the factory.
- Do not use volatile liquids, such as insect spray, near the DVD player. Do not leave rubber or plastic products in contact with the DVD player for a long time. They will leave marks on the finish.
- The top and rear panels of the DVD player may become warm after a long period of use. This is not a malfunction.
- When the DVD player is not in use, be sure to remove the disc and turn off the power.
- If you do not use the DVD player for a long period, the unit may not function properly in the future. Turn on and use the DVD player occasionally.

Notes on Placement

- When you place this DVD player near a TV, radio, or VCR, the playback picture may become poor and the sound may be distorted. In this case, place the DVD player away from the TV, radio, or VCR.

Notes on Cleaning

Use a soft, dry cloth for cleaning.

- For stubborn dirt, soak the cloth in a weak detergent solution, wring well and wipe. Use a dry cloth to wipe it dry. Do not use any type of solvent, such as thinner and benzene, as they may damage the surface of the DVD player.
- If you use a chemical saturated cloth to clean the unit, follow that product's instructions.

To Obtain a Clear Picture

The DVD player is a high technology, precision device. If the optical pick-up lens and disc drive parts are dirty or worn down, the picture quality becomes poor. To obtain a clear picture, we recommend regular inspection and maintenance (cleaning or parts replacement) every 1,000 hours of use depending on the operating environment. For details, contact your nearest dealer.

Notes on Moisture Condensation

Moisture condensation damages the DVD player. Please read the following carefully.

Moisture condensation occurs, for example, when you pour a cold drink into a glass on a warm day. Drops of water form on the outside of the glass. In the same way, moisture may condense on the optical pick-up lens inside this unit, one of the most crucial internal parts of the DVD player.

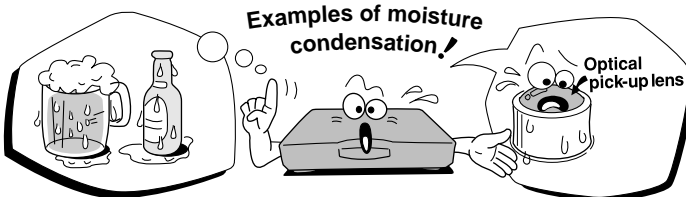

■ **Moisture condensation occurs during the following cases.**

- When you bring the DVD player directly from a cold place to a warm place.
- When you use the DVD player in a room where you just turned on the heater, or a place where the cold wind from the air conditioner directly hits the unit.
- In summer, when you use the DVD player in a hot and humid place just after you move the unit from an air conditioned room.
- When you use the DVD player in a humid place.

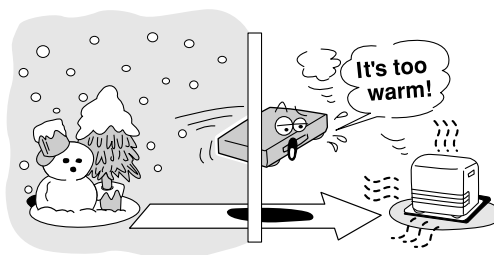

■ **Do not use the DVD player when moisture condensation may occur.**

If you use the DVD player in such a situation, it may damage discs and internal parts. Remove the disc, connect the power cord of the DVD player to the wall outlet, turn on the DVD player, and leave it for two or three hours. After two or three hours, the DVD player will have warmed up and evaporated any moisture. Keep the DVD player connected to the wall outlet and moisture condensation will seldom occur.

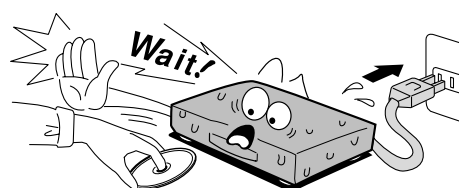

Features

- Audiophile-class DVD/CD player
- Component Video Outputs (Gold-Plated)
- Dolby Digital Audio Output
- 10-Bit Video D/A conversion
- Optical & Coaxial digital audio output
- Complete front-panel control
- 4-power picture zoom
- Brushed aluminum front panel

Table of Contents

Introduction

- Safety Precautions 2-3
- Important Safeguards 4
- Precautions 5
- Features 6
- Identification of Controls 8-11
 - Front Panel/Rear Panel/DVD display
 - Remote Control
 - Preparing the Remote Control
 - Operating with the Remote Control

Introduction

Connections

- Connecting to a TV 12
- Connecting to an Audio System or TV with COMPONENT VIDEO Inputs 13
- Connecting to Optional Equipment ... 14, 15
 - Enjoying Dolby Digital Sound
 - Enjoying Dolby Pro Logic Surround Sound
 - Enjoying 2 Channel Digital Stereo Sound

Connections

Basic Playback

- Playing Back a Disc 16-19
 - Basic Playback
 - Playing at $\times 2$, $\times 8$ or $\times 30$ the Normal Speed
 - Playing Frame by Frame
 - Playing in Slow-Motion
 - Resuming Playback from the Same Location
- Locating a Specific Title, Chapter, or Track 20, 21
 - Locating a Title Using the Title Menu
 - Locating a Title
 - Locating a Specific Chapter or Track Directly
 - Locating a Specific Chapter or Track
 - Locating a Specific Location Within a Title

Basic Playback

Advanced Playback

- Playing Repeatedly 22
 - Repeating a Title, Chapter, or Track
 - Repeating a Specific Segment
- Playing in a Favorite Order 23
 - Setting Titles, Chapters, or Tracks in a Favorite Order
- Playing in Random Order 24
 - Playing Titles in Random Order
 - Playing Chapters or Tracks in Random Order
- Zooming a Picture 25
 - Zooming a Picture
- Selecting the Camera Angle 26
 - Changing the Camera Angle
- Selecting a Language 27
 - Selecting a Playback Audio Setting
- Selecting Subtitles 28
 - Displaying Subtitles
 - Selecting a Subtitle Language
- Using the On-Screen Display 29
 - Checking the Operational Status
 - Checking the Remaining Time and Setting Status

Advanced Playback

Function Setup

- Customizing the Function Settings 30-36
 - Displaying the SET UP MENU Screen
 - Setting the Audio Sound
 - Setting the Functions
 - Setting the Displays
- Setting the Parental Lock 37, 38
 - Setting the Parental Lock
- Table of Languages 39
 - Table of Languages and Their Abbreviations

Function Setup

Others

- Notes on Discs 40
 - On Handling Discs
 - On Cleaning Discs
 - On Storing Discs
 - About This Instruction Manual
 - Playable Discs
 - Notes on Region Numbers
 - Notes on Copyright
- Before Calling Service Personnel 41
 - Symptoms and Correction
- Specifications 42
 - DVD Player/Outputs/Supplied Accessories

Others

Identification of Controls

See the page in  for details.

Front Panel/Rear Panel/DVD Display

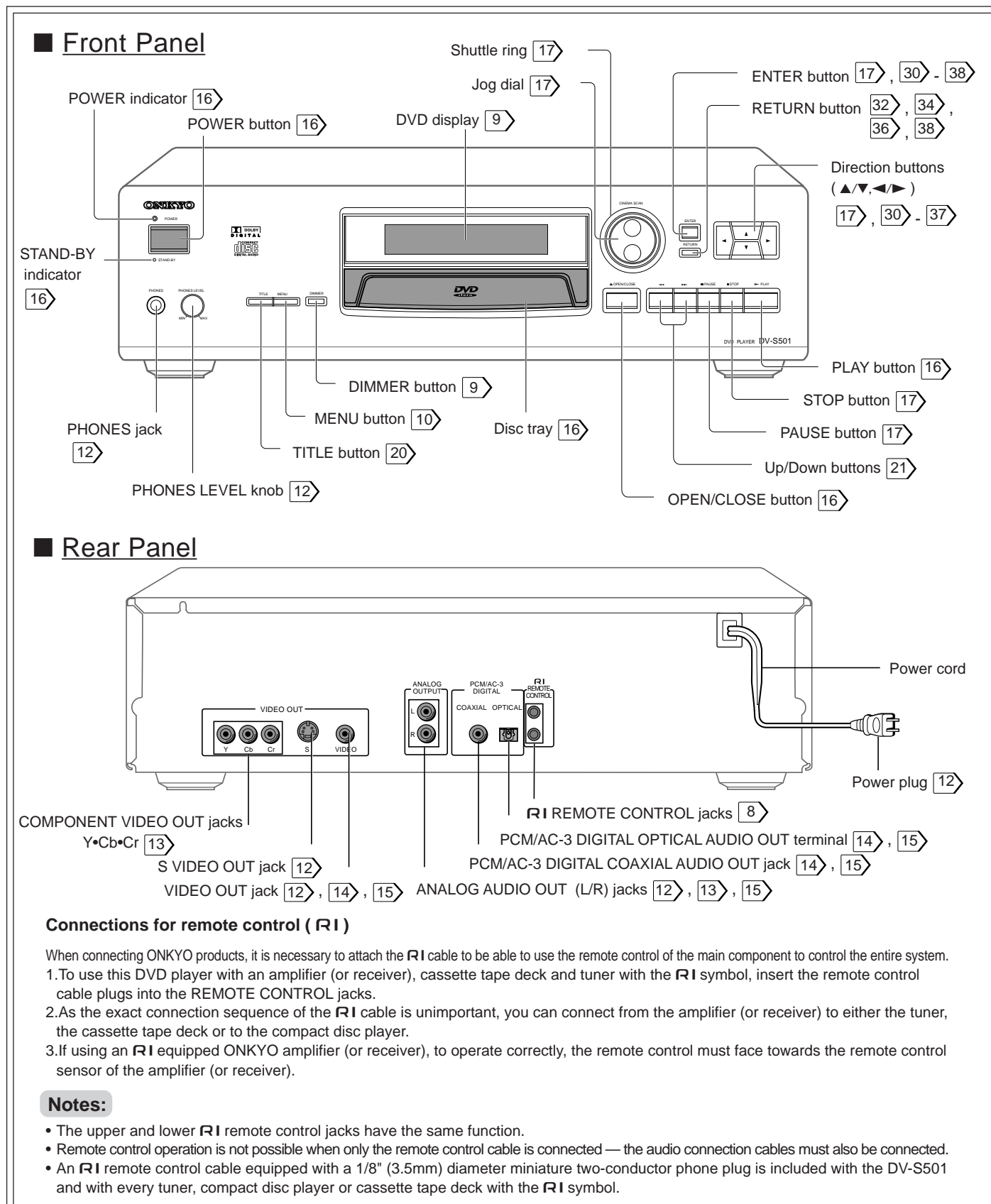

DVD Display

- Pressing of the DIMMER button changes the brightness of the Display.

Normal → Dimmed → Off

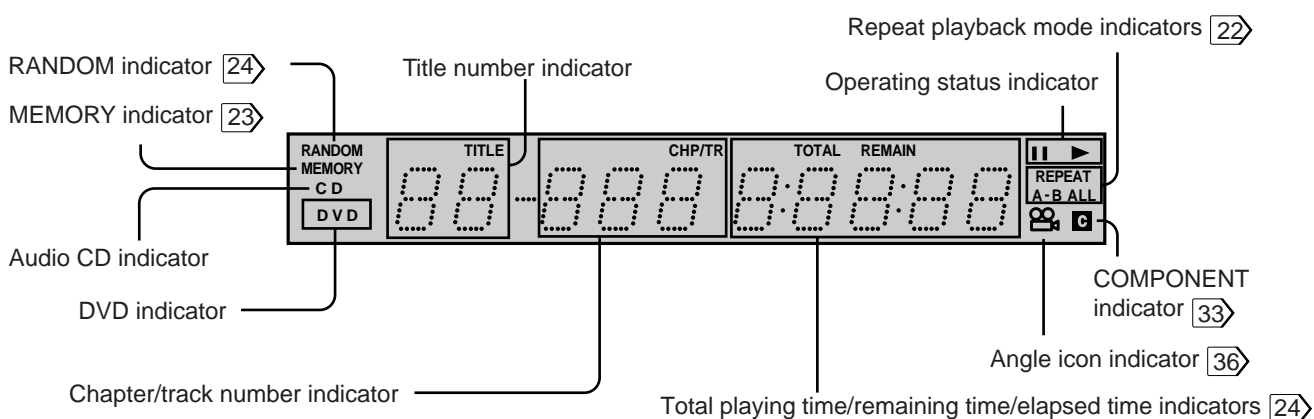

The indicators vary depending on the kinds of discs you play.

DVD Video disc

- When closing the disc tray:

Example

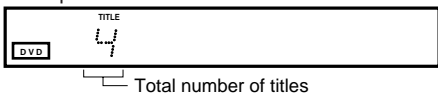

- During playback:

Example

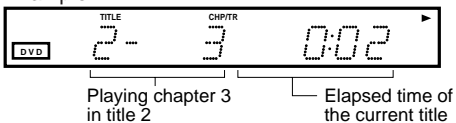

Some DVD video discs may not display the chapter numbers or elapsed time.

Other indicators

REPEAT When playing back the same title, chapter or track repeatedly. [22]

⏸ When playback is paused. [16]

COMPONENT When "COMPONENT VIDEO OUT." is set via the on-screen display. [33]

REPEAT A-B When playing back a specific segment repeatedly. (A-B repeat) [22]

MEMORY During memory playback. [23]

RANDOM During random playback. [24]

Audio CD

- When closing the disc tray:

Example

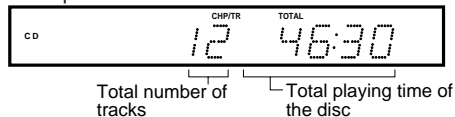

- During playback:

Example

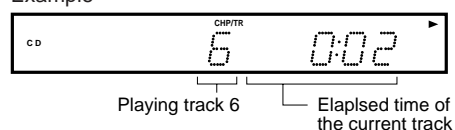

REPEAT ALL When playing back the entire disc repeatedly. [22]

ANGLE When the camera angle can be changed. [26]

Identification of Controls (continued)

The instructions in this manual describe the controls on the remote control. See the page in  for details.

Remote Control

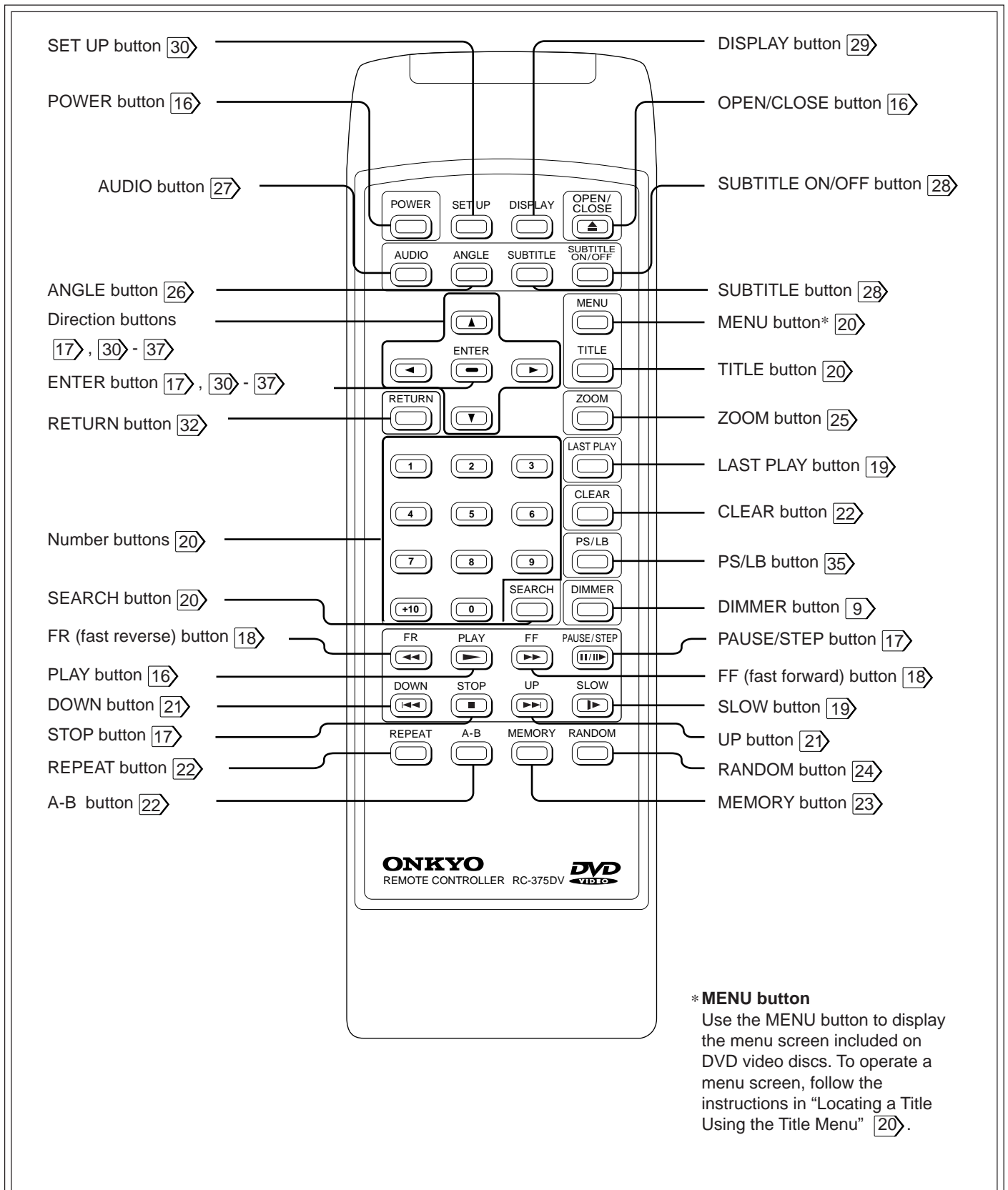

*** MENU button**

Use the MENU button to display the menu screen included on DVD video discs. To operate a menu screen, follow the instructions in "Locating a Title Using the Title Menu" [20](#).

Preparing the Remote Control

Insert the batteries into the remote control so you can use it to operate the DVD player.

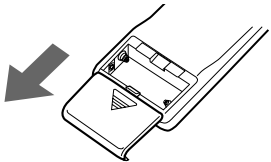
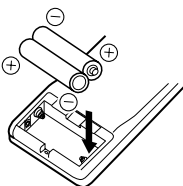
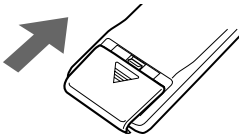
1	<p>Open the cover.</p> 
2	<p>Insert batteries (AA size).</p>  <p>Make sure to match the + and – on the batteries to the marks inside the battery compartment.</p>
3	<p>Close the cover.</p> 

Notes on batteries:

Improper use of batteries may cause battery leakage and corrosion. To operate the remote control correctly, follow the instructions below.

- Do not insert the batteries into the remote control in the wrong direction.
- Do not charge, heat, open, or short-circuit the batteries. Do not throw the batteries into a fire.
- Do not leave dead or exhausted batteries in the remote control.
- Do not use different types of batteries together, or mix old and new batteries.
- If you do not use the remote control for a long period of time, remove the batteries to avoid possible damage from battery corrosion.
- If the remote control does not function correctly or if the operating range becomes reduced, replace all batteries with new ones.
- If battery leakage occurs, wipe the battery liquid from the battery compartment, then insert new batteries.
- The batteries should last about one year with normal use.

Operating with the Remote Control

This section shows you how to use the remote control.

Point the remote control at the remote sensor and press the buttons.

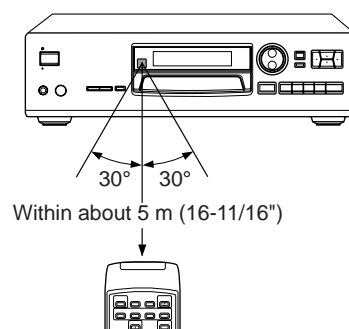

Distance: About 5 m (16-11/16") from the front of the remote sensor
 Angle: About 30° in each direction of the front of the remote sensor

* Do not expose the remote sensor of the DVD player to a strong light source such as direct sunlight or illumination. If you do so, you may not be able to operate the DVD player with the remote control.

Notes on the remote control:

- Direct the remote control at the remote sensor of the DVD player.
- Do not drop or give the remote control a shock.
- Do not leave the remote control near an extremely hot or humid place.
- Do not spill water or put anything wet on the remote control.
- Do not open the remote control.

Connecting to a TV

Connect the DVD player to your TV.

Connecting to a TV

- Setting of the output sound type
From the on-screen displays, set the "AUDIO OUT SEL." to "PCM". [31], [32]
- Setting of the video output type
From the on-screen displays, set the "VIDEO OUT SEL." to "S" when using the S VIDEO OUT jack. [31], [33]
The Composite Video (yellow) output of the DVD player is always operational regardless of output mode selected ("C" or "S") via the on-screen display.

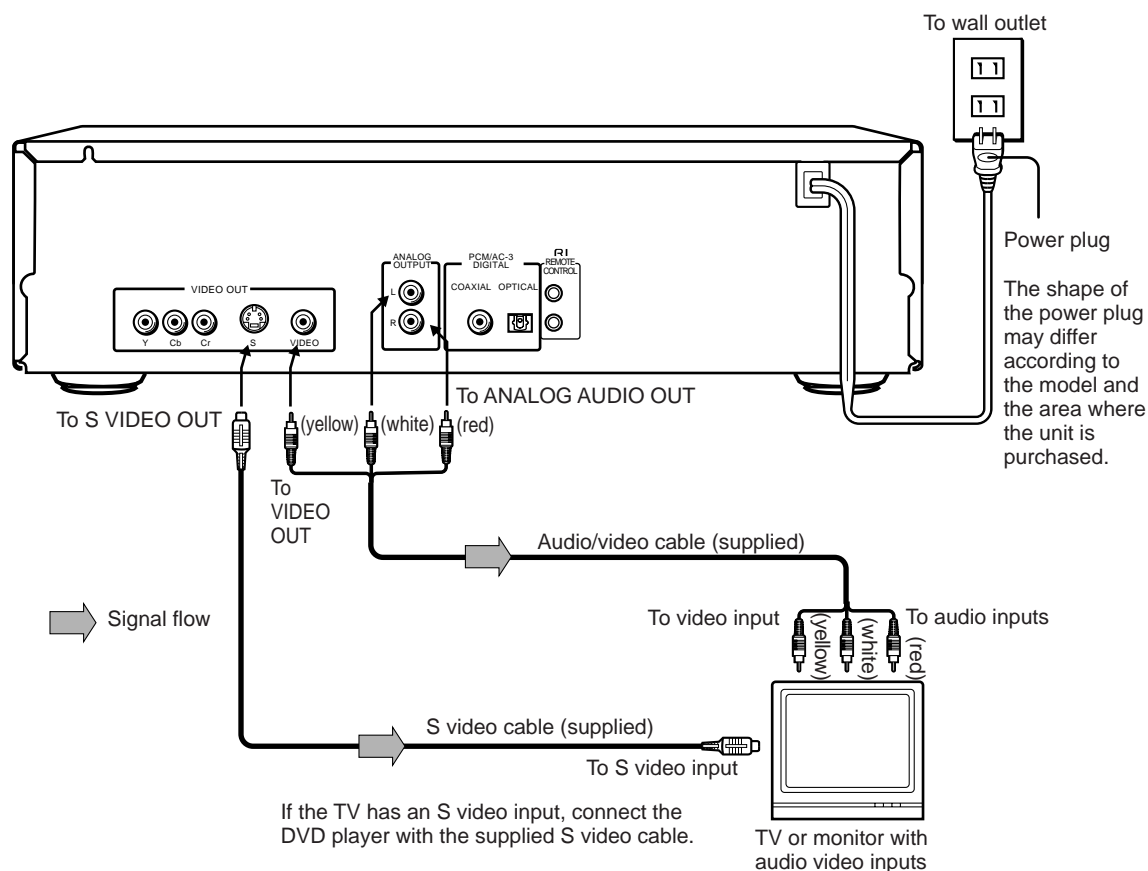

Notes:

- Refer to the instruction manual of the connected TV and how to activate TV input as well.
- When you connect the DVD player to your TV, be sure to turn off the power and unplug both units from the wall outlet before making any connections.
- If your television set has one audio input, connect the DVD player to a Y cable adapter (not supplied) and then connect to your TV.
- Connect the DVD player to your TV directly. If you connect the DVD player to a VCR, TV/VCR combination or video selector, the playback picture will be distorted because DVD discs are copy protected.

Connecting headphones

Connect headphones to the PHONES jack on the front panel using a stereo plug.

Before connecting, temporarily turn down the volume with the PHONES LEVEL knob. Readjust to your preference when playback begins.

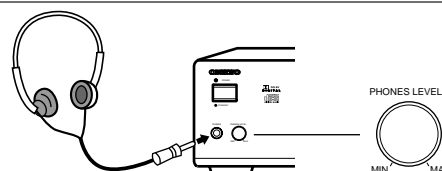

Connecting to an Audio System or TV with COMPONENT VIDEO Inputs

You can listen to the sound of audio CDs and DVD video discs in stereo and enjoy the enhanced picture quality of DVD video discs on a TV with COMPONENT VIDEO inputs.

Connecting to an Audio System or TV with COMPONENT VIDEO Inputs

■ Setting of the output sound type

From the on-screen displays, set the "AUDIO OUT SEL." to "PCM". [31](#), [32](#)

■ Setting of the video output type

From the on-screen displays, set the "VIDEO OUT SEL." to "C" when using the COMPONENT VIDEO OUT jacks (Y, Cb, Cr). [31](#), [33](#)

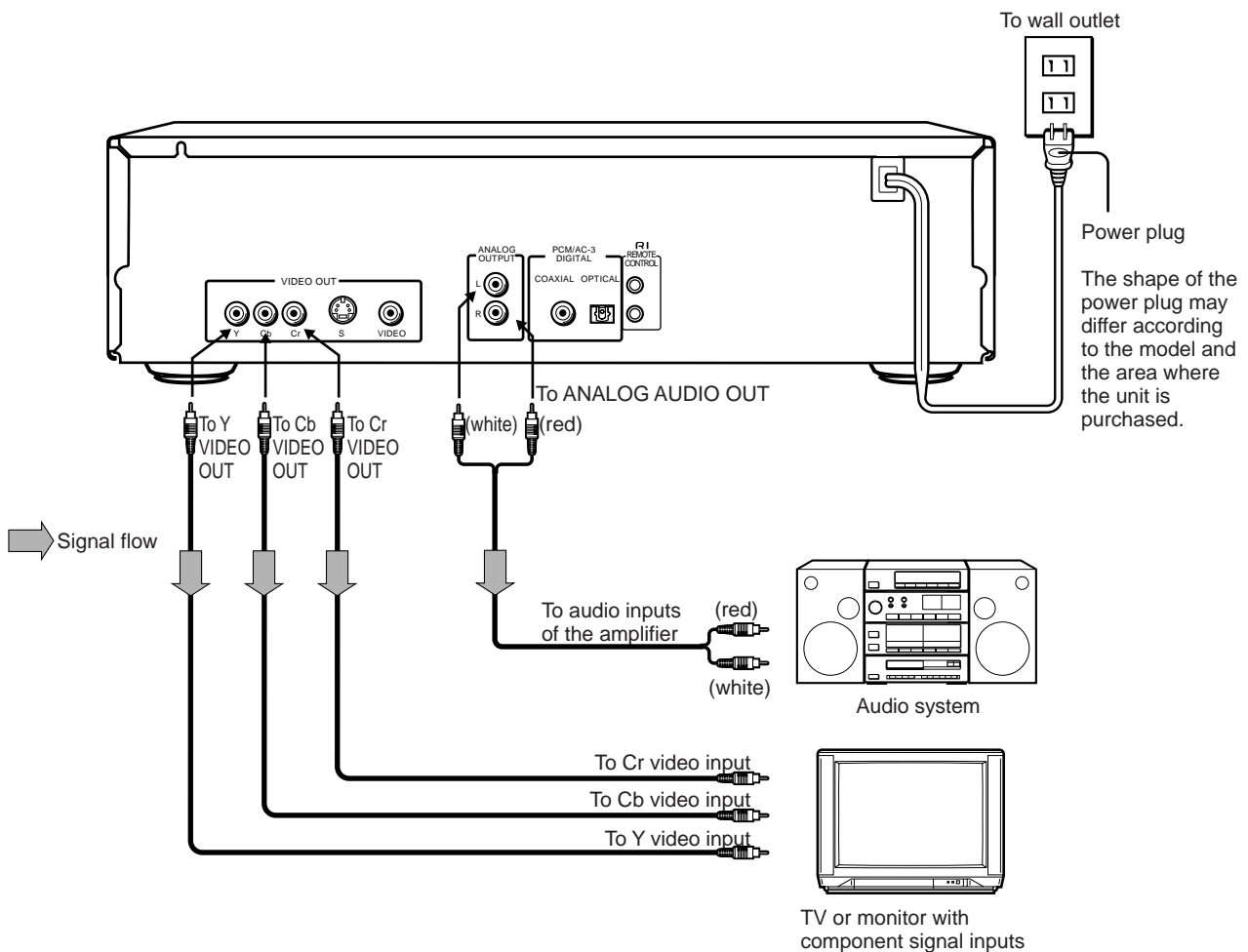

COMPONENT VIDEO OUT (COLOR DIFFERENCE):

Some TVs or monitors are equipped with color difference inputs. Connecting to these inputs allows you to enjoy higher quality picture playback.

Actual labels for color difference inputs may vary depending on the TV manufacturer. (ex. Y, B-Y, R-Y etc.)

In some TVs or monitors, the color levels of the playback picture may be reduced slightly or the tint may change. In such a case, adjust the TV or monitor for the optimum performance.

Notes:

- Refer to the instruction manual of the connected equipment as well.
- When you connect the DVD player to other equipment, be sure to turn off the power and unplug all of the equipment from the wall outlet before making any connections.
- If you place the DVD player near a tuner or radio, the radio broadcast sound might be distorted. In this case, place the DVD player away from the tuner and radio.
- The output sound of the DVD player has a wide dynamic range. Be sure to adjust the receiver's volume to a moderate listening level. Otherwise, the speakers may be damaged by a sudden high volume sound.
- Turn off the amplifier before you connect or disconnect the DVD player's power cord. If you leave the amplifier power on, the speakers may be damaged.

Connecting to Optional Equipment

You can enjoy the high quality dynamic sound of Dolby Digital, Dolby Pro Logic, and 2 Channel Digital Stereo.

Enjoying Dolby Digital Sound

Dolby Digital

Dolby Digital is the surround sound technology used in theaters showing the latest movies, and is now available to reproduce this realistic effect in the home. You can enjoy motion picture and live concert DVD video discs with this dynamic realistic sound by connecting the DVD player to a 6 channel amplifier equipped with a Dolby Digital decoder or Dolby Digital processor. If you have a Dolby Pro Logic Surround decoder, you will obtain the full benefit of Pro Logic from the same DVD movies that provide full 5.1-channel Dolby Digital soundtracks, as well as from titles with the Dolby Surround mark.

■ Setting of the output sound type

- From the on-screen displays, set the "AUDIO OUT SEL." to "AC-3".
[31], [32]
- Select the sound recording system of the disc to "AC-3" on the audio setting indication. [27]

Standard equipment to enjoy Dolby Digital

- The DVD player (equipped with an AC-3 output jack)
- DVD video discs recorded in Dolby Digital
- 6 channel amplifier equipped with a Dolby Digital decoder, or Dolby Digital processor and power amplifier
- 5 speakers and 1 sub woofer

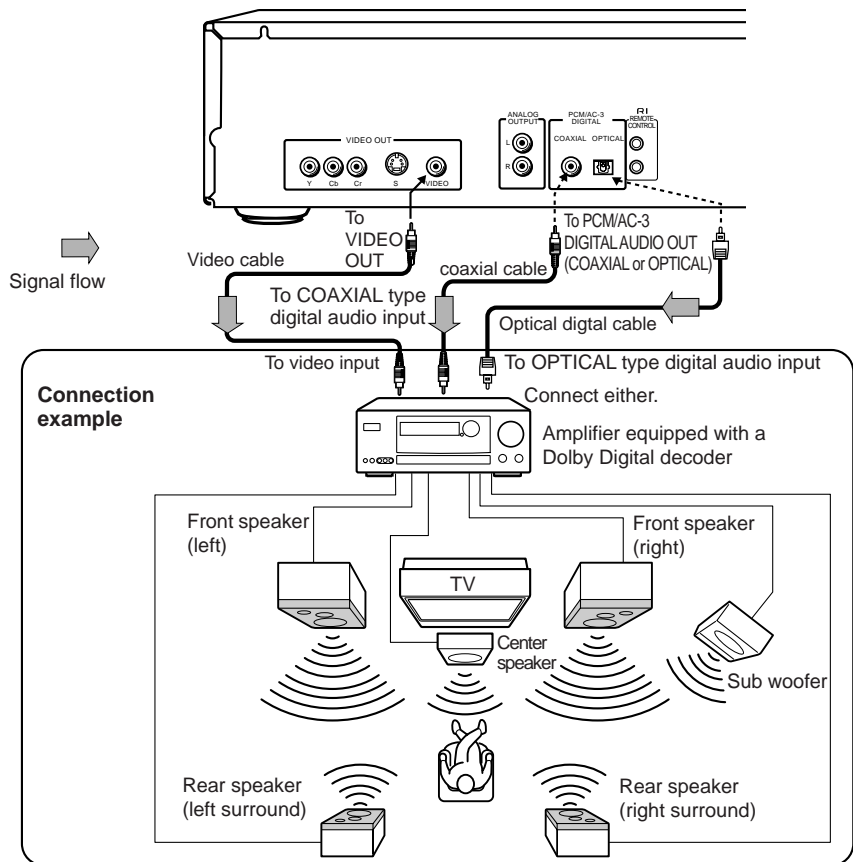

Manufactured under license from Dolby Laboratories Licensing Corporation. "Dolby," "AC-3," "Pro Logic," and the double-D symbol are trademarks of Dolby Laboratories Licensing Corporation.

Notes:

- DO NOT connect the PCM/AC-3 DIGITAL AUDIO OUT jack of the DVD player to the AC-3 RF input of a Dolby Digital Receiver. This input on your A/V Receiver is reserved for Laserdisc use only and is incompatible with the PCM/AC-3 DIGITAL AUDIO OUT jack of the DVD player.
- Connect the PCM/AC-3 DIGITAL AUDIO OUT jack of the DVD player to the "DIGITAL" or "COAXIAL" input of a Dolby Digital Receiver or Processor.
- Refer to the instruction manual of the connected equipment as well.
- When you connect the DVD player to other equipment, be sure to turn off the power and unplug all of the equipment from the wall outlet before making any connections.
- The output sound of the DVD player has a wide dynamic range. Be sure to adjust the receiver's volume to a moderate listening level. Otherwise, the speakers may be damaged by a sudden high volume sound.
- Turn off the amplifier before you connect or disconnect the DVD player's power cord. If you leave the amplifier power on, the speakers may be damaged.

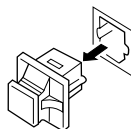

When connecting the optical digital cable, remove the cap and fit the connector into the jack firmly. When not using the jack, keep it capped to protect it from dust intrusion.

Warning

Do not set the "AUDIO OUT SEL." to "AC-3" on the setting screen [31] [32] unless you are connecting (via the PCM/AC-3 DIGITAL AUDIO OUT jack) an AV decoder that has the Dolby Digital decoding function. High volume sound may damage your hearing as well as the speaker.

Enjoying Dolby Pro Logic Surround Sound

Dolby Pro Logic Surround

You can enjoy the dynamic realistic sound of Dolby Pro Logic Surround by connecting an amplifier and speaker system (right and left front speakers, a center speaker, and one or two rear speakers).

- **With an amplifier equipped with Dolby Digital**
Connect the equipment the same way as described in "Enjoying Dolby Digital Sound". [14]
Refer to that amplifier's instruction manual and set the amplifier so you can enjoy Dolby Pro Logic Surround sound.
- **With an amplifier not equipped with Dolby Digital**
Connect the equipment as follows.

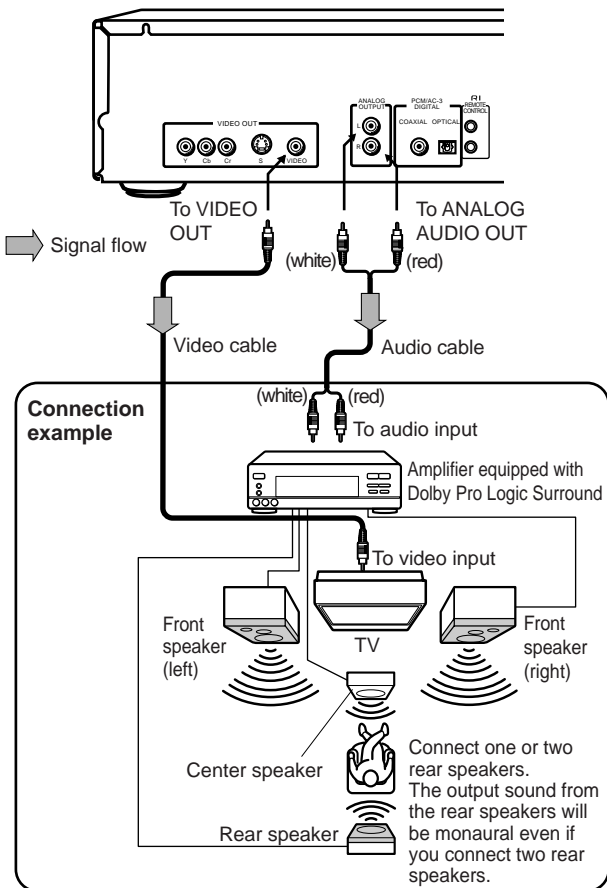

- Set "AUDIO OUT SEL." to "PCM" via the on-screen displays. [31], [32]

PCM : Pulse Code Modulation
2ch for Analog or Digital prefer connections for best 2ch or Dolby Surround Sound.

Enjoying 2 Channel Digital Stereo Sound

2 Channel Digital Stereo

You can enjoy the dynamic sound of 2 Channel Digital Stereo by connecting an amplifier equipped with a digital audio input and speaker system (right and left front speakers).

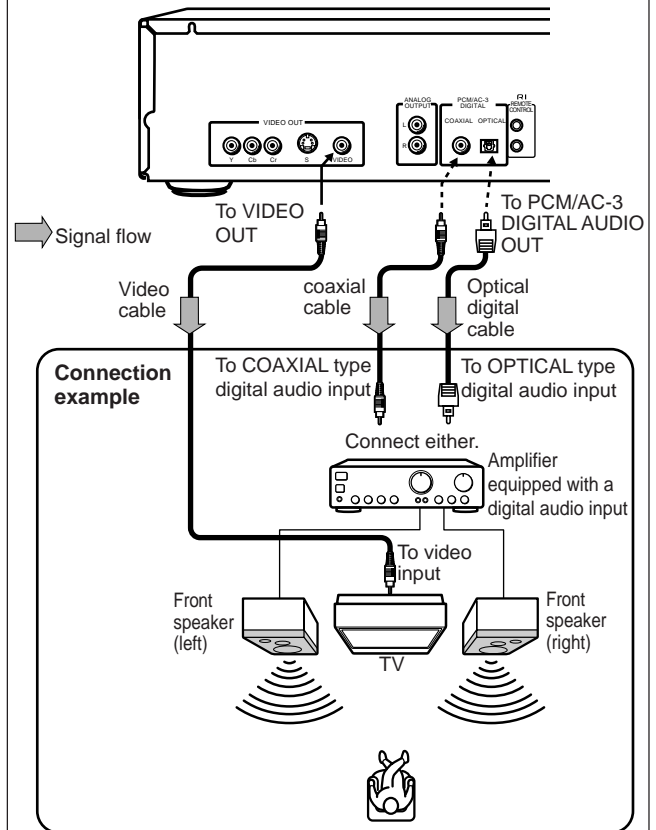

- Set "AUDIO OUT SEL." to "PCM" via the on-screen displays. [31], [32]

PCM : Pulse Code Modulation
2ch for Analog or Digital prefer connections for best 2ch or Dolby Surround Sound.

Notes:

- Refer to the instruction manual of the connected equipment as well.
- When you connect the DVD player to other equipment, be sure to turn off the power and unplug all of the equipment from the wall outlet before making any connections.
- The output sound of the DVD player has a wide dynamic range. Be sure to adjust the receiver's volume to a moderate listening level. Otherwise, the speakers may be damaged by a sudden high volume sound.
- Turn off the amplifier before you connect or disconnect the DVD player's power cord. If you leave the amplifier power on, the speakers may be damaged.

Playing Back a Disc

CAUTION
Keep your fingers well clear of the disc tray as it is closing. It may cause serious personal injury.

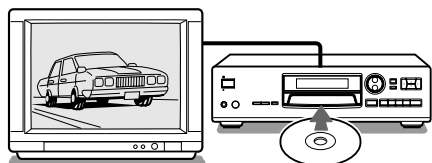



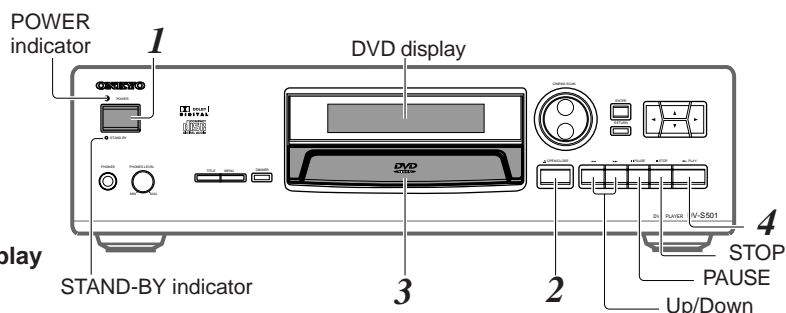

This section shows you the basics on how to play back a DVD video disc or audio CD.



Basic Playback

■ Preparations

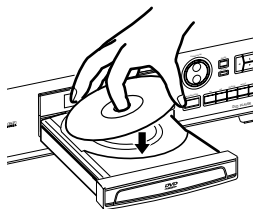
- When you want to play back DVD video discs, turn on the TV and select the video input source connected to the DVD player.
- When you want to enjoy the sound of DVD video discs or audio CDs from the audio system, turn on the audio system and select the input source connected to the DVD player.
- For connection details, see "Connections". [12](#) - [15](#)
- Set the playback picture size according to the aspect ratio of the connected TV via the on-screen displays. [30](#), [35](#)
- If you do not have the necessary equipment to enjoy Dolby Digital sound, set the AUDIO OUT SEL. to "PCM" via the on-screen displays. [31](#), [32](#)

1		<h3>Connecting the power supply.</h3> <ol style="list-style-type: none"> 1. Plugging the power cord into an AC wall outlet. The STAND-BY indicator on the player illuminates. 2. Press the POWER button. The DVD player turns on and the POWER indicator on the player illuminates. 	
2		<h3>Press OPEN/CLOSE.</h3> <p>The disc tray opens.</p>	<p>Note:</p> <p>You can open the disc tray by pressing this button even if the DVD player is turned off.</p>
3		<h3>Place the disc on the disc tray.</h3> <p>With the playback side down</p>	<p>Notes:</p> <ul style="list-style-type: none"> • There are two different disc sizes. Place the disc in the correct guide on the disc tray. If the disc is out of the guide, it may damage the disc and cause the DVD player to malfunction. • Do not place anything except DVD video discs or audio CDs on the disc tray.
4		<h3>Press PLAY.</h3> <p>The disc tray closes and playback starts.</p> <p>If you insert a DVD video disc that contains a title menu, the menu screen appears. See "To start playback from the menu screen" 17.</p>	<p>Note:</p> <p>You may need to press the TITLE or MENU button to display the menu screen depending on the DVD video discs.</p>

Notes:

- Do not move the DVD player during playback. Doing so may damage the disc.
- Use the OPEN/CLOSE button on the remote control or DVD player to open and close the disc tray. Do not push the disc tray while it is moving. Doing so may cause the DVD player to malfunction.
- Do not push up on the disc tray or put any objects other than discs on the disc tray. Doing so may cause the DVD player to malfunction.

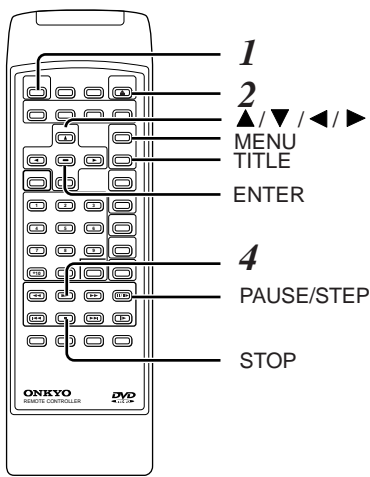

■ **To obtain a higher quality picture**

Occasionally, some picture noise not usually displayed with a normal broadcast may appear on the TV screen while playing back a DVD video disc because the high resolution pictures on these discs include a lot of information. While the amount of noise depends on the TV you use with this DVD player, you should generally reduce the sharpness adjustment on your TV when viewing DVD video discs.

■ **About DVD CD**

The DVD CD icons on the heading bar show the playable discs for the function described under that heading.

DVD : You can use this function with DVD video discs

CD : You can use this function with audio CDs



■ **To start playback from the menu screen**

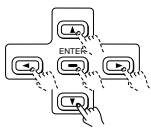

1 Press ▲ / ▼ / ◀ / ▶ or the number buttons to select the title you want.

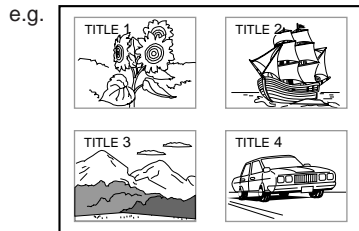

2 Press ENTER. The DVD player starts playback from the selected title.

■ **To pause playback (still mode)**



Press PAUSE/STEP during playback.

To resume normal playback, press the PLAY button.

- The sound is muted during still mode.

■ **To stop playback**

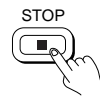

Press STOP.

The DVD player returns to chapter 1 or track 1.

■ **To remove the disc**



Press OPEN/CLOSE.

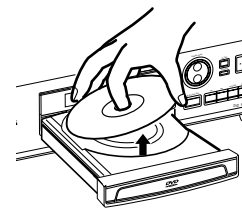

Remove the disc after the disc tray opens completely.

- Be sure to press the OPEN/CLOSE button to close the disc tray after you remove the disc.

■ **To change the playback speed using CINEMA SCAN**

You can view pictures at a variety of speeds by turning the inner jog dial or the outer shuttle ring.

■ **Jog dial**

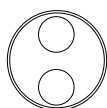

Turn during still playback.

Forward: To advance the picture frame by frame.

Reverse: To reverse the picture frame by frame.

- The reverse frame playback may advance more rapidly than in forward
- The jog dial does not function during audio CD playback.

■ **Shuttle ring**

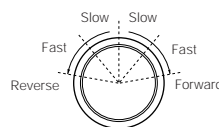

Turn during normal playback or still playback.

The playback speed can be controlled by the extent of the wheel rotation.

- The playback speed may differ depending on the discs.
- If you slow down the playback speed of DVD video disc by turning the ring leftward, the DVD player performs reverse frame playback. The reverse frame playback may advance more rapidly than in forward.
- You cannot slow down the playback speed of audio CDs.

Note:

In many instances, a menu screen will appear after playback of a movie is completed. Prolonged display of an on-screen menu may damage your television set permanently etching that image onto its screen. To avoid this, be sure to press the STOP button on your remote control once the movie is completed.

Playing Back a Disc (continued)

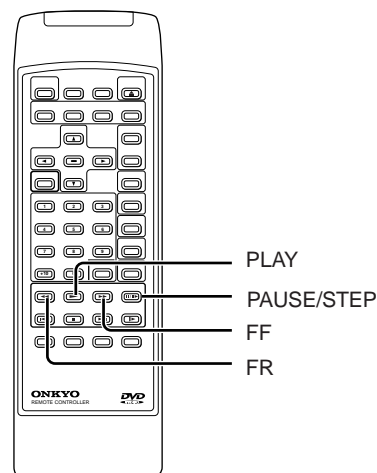
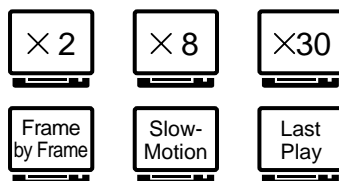

You can play back discs at various speeds, and resume playback from the location where you stopped playback.

Playing at $\times 2$, $\times 8$ or $\times 30$ the Normal Speed

You can play back a disc at $\times 2$, $\times 8$ or $\times 30$ the normal speed.

Press FR or FF during playback.



- DVD video disc
The playback speed becomes $\times 2$ the normal speed.
Each time you press the FR or FF button, the playback speed changes.

FR: Fast reverse playback
FF: Fast forward playback

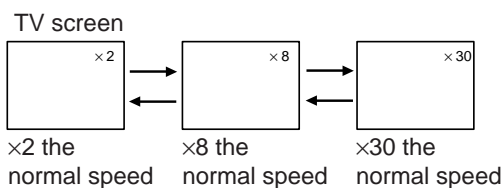

- Audio CD
The fast reverse or fast forward playback alternates between two speeds.

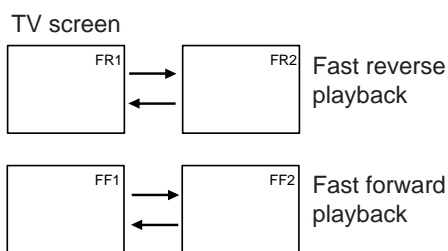

■ To resume normal playback



Press PLAY.

Playing Frame by Frame

You can advance a DVD video disc frame by frame.

Press PAUSE/STEP during still playback.



Each time you press the PAUSE/STEP button, the picture advances one frame.

■ To resume normal playback



Press PLAY.

Notes:

- The DVD player does not play back sound and subtitles during scan reverse and forward of DVD video discs. However, the DVD player plays back sound during fast forward or fast reverse playback of audio CDs.
- The $\times 2$, $\times 8$ and $\times 30$ speeds are only approximate speeds. These speeds may vary slightly from disc to disc.

Note:

The sound is muted during frame by frame playback.

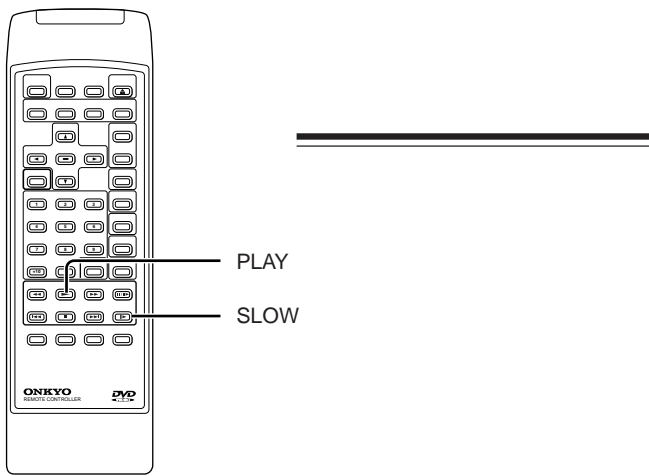

Playing in Slow-Motion DVD

You can play back a DVD video disc in slow-motion.



Press SLOW during playback.

The playback speed becomes half the normal speed.

Each time you press the SLOW button, the slow-motion speed changes.

TV screen

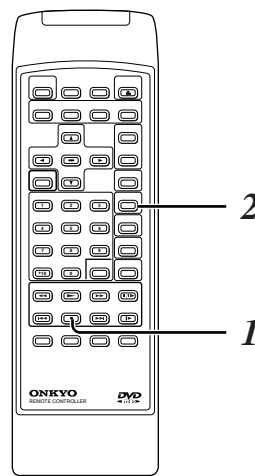
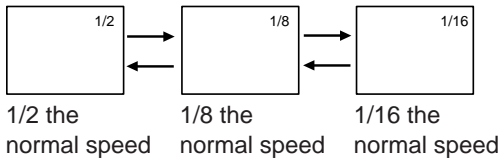

Resuming Playback from the Same Location DVD CD

You can stop playback and resume playback later from the same location on the disc.

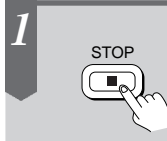

Press STOP at the location where you want to interrupt playback.

- The DVD player memorizes the location where you stopped playback.
- The DVD player stores that location in its memory even if you turn off the player.



Press LAST PLAY.

The DVD player resumes playback from the location where you stopped playback.

■ To resume normal playback



Press PLAY.

Note:

The sound is muted during slow-motion playback.

Notes:

- The Last Play function is canceled when:
 - you unplug the DVD player from the wall outlet after you stop playback.
 - you eject the disc.
 - you adjust/change parental lock [37] or select a disc menu language setting [36].
- There may be a difference of the location where playback resumes depending on the discs.

Locating a Specific Title, Chapter, or Track

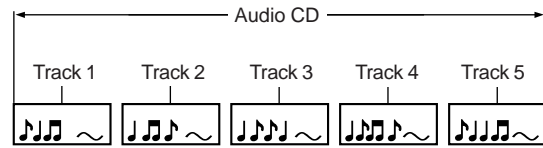
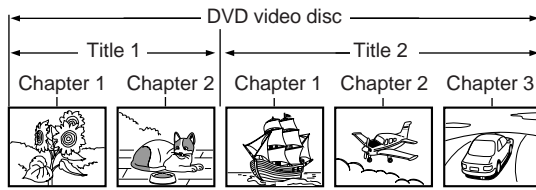

Normally, DVD video discs are divided into titles, and the titles are sub-divided into chapters. Audio CDs are divided into tracks. You can quickly locate any specific title, chapter, or track.

Locating a Title Using the Title Menu DVD

If a DVD video disc contains a title menu, you can locate a specific title using the title menu function.

1 **Press TITLE.**
The title menu appears on the TV screen.
Example of a title menu

2 **Press ▲/▼/◀/▶ to select the title you want.**
If the titles in the title menu are assigned a number, you can directly locate a specific title by pressing its assigned number with the **number buttons**.

3 **Press ENTER.**
The DVD player starts playback from chapter 1 of the selected title.

Notes:

- The instructions above describe the basic procedure. The procedure varies depending on the contents of the DVD video disc. If different instructions appear on the TV screen, follow those instructions.
- If you display the title menu during playback and press the TITLE button again without selecting any title, the DVD player resumes playback from the point where you first pressed the TITLE button.

Locating a Title DVD

If a DVD video disc contains title numbers, you can locate a specific title by directly selecting a title number.

1 **Press SEARCH.**
Make sure that the space next to TITLE is highlighted.
e.g.

TITLE: █ CHAPTER: 1

2 **Press the corresponding number buttons for the title you want.**
e.g. To select title 2

2

TITLE: █ CHAPTER: 1

To select title 12

1

→

2

TITLE: █ CHAPTER: 1

3 **Press PLAY.**
The DVD player starts playback from chapter 1 of the selected title.

Notes:

- You can shift the highlight between next to TITLE and CHAPTER by pressing ▲/▼.
- Pressing the CLEAR button resets the TITLE and CHAPTER numbers. To clear the TITLE, CHAPTER display, press the SEARCH button several times.
- You can select a preferred language for on-screen displays.

30, 35

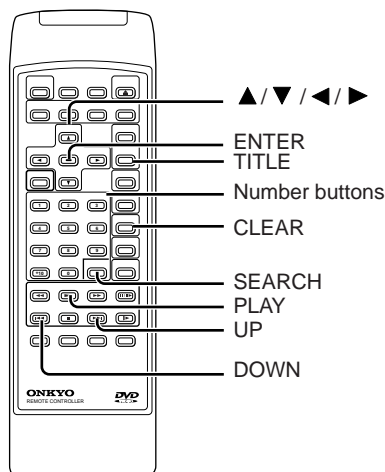

Locating a Specific Chapter or Track Directly

If you know the chapter or track number you want to play back, you can locate it directly.

- 1 Press SEARCH.**
Skip steps 1 and 2 if you are using an audio CD.
e.g. DVD video disc

TITLE: 1
CHAPTER: 1
- 2 Press ▼ to highlight the space next to CHAPTER.**
e.g. DVD video disc

TITLE: 1
CHAPTER: 1
- 3 Press the corresponding number buttons of the chapter or track you want.**
You can use the **+10** button to select numbers from 10 through 99.
e.g. To select chapter or track 25

DVD video disc Audio CD

 - [2] → [5] TITLE: 1 CHAPTER: 25 TRACK: 25
 - [+10] → [+10] → [5]
- 4 Press PLAY.**
The DVD player starts playback from the selected chapter or track.

■ To select a title and chapter number at the same time

e.g. To select chapter 25 in title 2

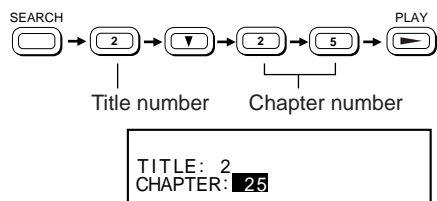

Note:

Pressing the CLEAR button resets the TITLE and CHAPTER numbers. To clear the TITLE, CHAPTER display, press the SEARCH button several times.

Locating a Specific Chapter or Track

You can locate consecutive chapters or tracks.

Press Down ◀◀ or Up ▶▶ repeatedly to display the chapter or track number you want.

The DVD player starts playback from the selected chapter or track.

◀◀: To locate preceding chapters or tracks
When you press the DOWN ◀◀ button, the DVD player starts playback from the beginning of the current chapter or track.
When you press the DOWN ◀◀ button twice, the DVD player starts playback from the beginning of the preceding chapter or track.

▶▶: To locate succeeding chapters or tracks

Note:

Some titles may not display the chapter number.

Locating a Specific Location Within a Title

You can locate a specific location by entering the time (hours, minutes, seconds).

- 1 Press SEARCH twice.**

TIME 00:00:00
- 2 Press the number buttons to enter the time.**
e.g. [1] → [2] → [5] → [3] → [0]

TIME 1:25:30
- 3 Press PLAY.**
The DVD player starts playback from the specified location.

Note:

Some discs may not respond to this locating.

Playing Repeatedly

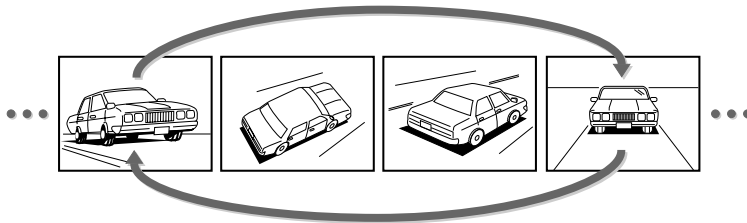

You can play back a specific title, chapter, track, or segment repeatedly. (Title repeat, chapter/track repeat, A-B repeat)

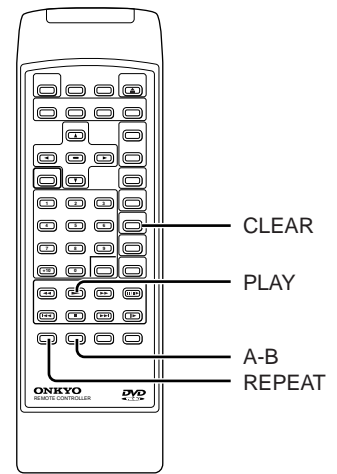

Repeating a Title, Chapter, or Track DVD CD

You can play back the same title, chapter, or track repeatedly. (Title, chapter/track repeat)





- 1 Select the title, chapter, or track you want to repeat.
[20], [21]
- 2  Press REPEAT.
Each time you press the REPEAT button, the repeat mode changes as follows.
 - DVD video disc
 - CHAPTER REPEAT Repeats the same chapter.
 - TITLE REPEAT Repeats the same title.
 - REPEAT OFF Resumes normal playback.
 - Audio CD
 - TRACK REPEAT Repeats the same track.
 - ALL REPEAT Repeats the entire disc.
 - REPEAT OFF Resumes normal playback.

■ To resume normal playback

 Press CLEAR.

Repeating a Specific Segment DVD CD

You can play back a specific segment repeatedly. (A-B repeat)

- 1  Press A-B at the beginning of the segment (point A) you want to play repeatedly.

- 2  Press A-B again at the end of the segment (point B).

The DVD player automatically returns to point A and starts repeat playback of the selected segment (A-B).

■ To resume normal playback

 Press CLEAR.

Notes:

- You can specify a segment only within the current title.
- You cannot set the A-B repeat function for segment that include multiple camera angles.
- There may be a slight difference between point A and the location where playback actually resumes depending on the discs.

Playing in a Favorite Order



You can combine your favorite titles, chapters, or tracks and play them back in any order. You can program up to 30 items into the memory. (Memory playback)

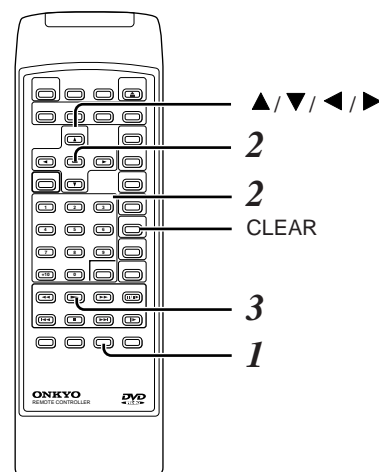

Setting Titles, Chapters, or Tracks in a Favorite Order

The DVD player automatically plays back titles, chapters, or tracks in the order you program.

1 **MEMORY**

Insert a disc and press **MEMORY** during stop.

The following menu appears.

MEMORY		SELECT: +
1	T--C--	6 T--C--
2	T--C--	7 T--C--
3	T--C--	8 T--C--
4	T--C--	9 T--C--
5	T--C--	10 T--C--

T: Title number
C: Chapter number

2

Select the items you want in order by pressing the number buttons, then **ENTER** for each item.

Each time you press the ◀/▶ button, the -- indication next to T and C is highlighted in turn. Highlight where you want to enter, then press the number buttons.

e.g. To play back chapter 25 in title 2, chapter 12 in title 2, all the chapters in title 1, and chapter 2 in title 4.

Memory 1: ◀ → 2 → ▶ → 2 → 5 → ENTER

Memory 2: 1 → 2 → ENTER

Memory 3: ◀ → 1 → ENTER

Memory 4: ◀ → 4 → ▶ → 2 → ENTER

To select tracks from an audio CD in order, press the **number buttons** for the track, then press the **ENTER** button for each item you want.

MEMORY		SELECT: +
1	T02C25	6 T--C--
2	T02C12	7 T--C--
3	T01C--	8 T--C--
4	T04C02	9 T--C--
5	T--C--	10 T--C--

Press PLAY while the **MEMORY** menu appears on the TV screen.

The DVD player starts memory playback.

- 3** **PLAY**
- To change the programmed items**
- While the MEMORY menu appears on the TV screen, press ▲/▼ to move the highlighted bar to the item you want to change.
 - Change the item following the instructions in step 2.
- To cancel the programmed items**
- While the MEMORY menu appears on the TV screen, press ▲/▼ to move the highlighted bar to the item you want to cancel.
 - Press the CLEAR button.
- To resume normal playback from memory playback**
- CLEAR** Press **CLEAR**. The MEMORY indicator disappears.

- Notes:**
- If you press the MEMORY button during memory playback, the programmed items will be displayed.
 - You cannot select title, chapter, and track numbers not included on the disc.
 - If you press the MEMORY or RETURN button while the MEMORY menu appears on the TV screen, the MEMORY menu disappears.
 - The programmed items will be cleared when:
 - you turn off the DVD player, or
 - you remove the disc.
 - Memory playback is not available for some type of DVD video discs.

Advanced Playback

Playing in Random Order

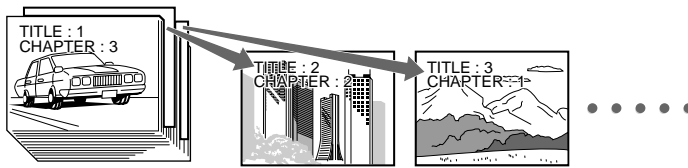

You can play back titles, chapters within a title, or tracks in random order. (Random playback)

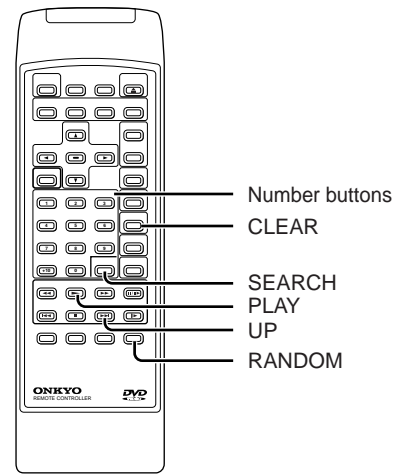

Playing Titles in Random Order DVD

The DVD player automatically selects the titles in a DVD video disc and plays them back randomly.

1 **Press RANDOM twice during stop.**

TITLE RANDOM

If you press the RANDOM button during playback, the DVD player automatically starts random playback after finishing the current title.

2 **Press PLAY.**

The DVD player starts random playback.

Press the PLAY button within about 5 seconds after you press the RANDOM button.

■ To resume normal playback



Note:

You cannot use the random playback function in conjunction with the memory playback function.

Playing Chapters or Tracks in Random Order DVD CD

The DVD player automatically selects chapters within a title, or tracks on an audio CD, and plays them back randomly.

1 **Press the appropriate number buttons for the title which contains the chapters you want to play back in random order.**

Skip this step if you are using audio CD.

e.g. To play back the chapters in title 2 in random order

SEARCH →

2

TITLE: 2
CHAPTER: 1

2 **Press RANDOM during stop.**

CHAPTER RANDOM
TITLE: 2
CHAPTER 1

If you press the RANDOM button during playback, the DVD player automatically starts random playback after finishing the current chapter or track.

3 **Press PLAY.**

The DVD player starts random playback.

Press the PLAY button within about 5 seconds after you press the RANDOM button.

■ To resume normal playback



Notes:

- You cannot use the random playback function in conjunction with the memory playback function.
- If you press the UP ►►► button during random playback, the DVD player goes to another chapter or track and starts playback.

Zooming a Picture

Zoom playback

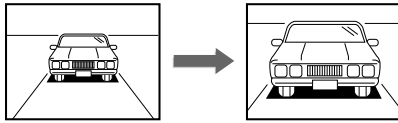

You can magnify areas within a picture. (Zoom playback)

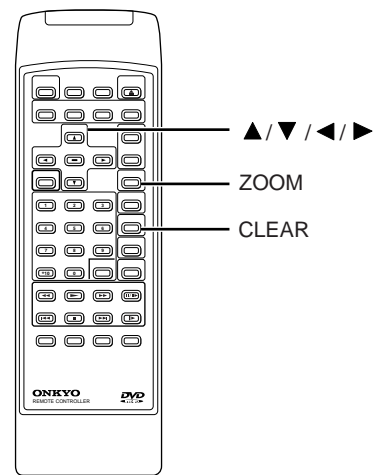

Zooming a Picture

DVD

You can zoom a picture. You can shift the zoom point as well.

ZOOM



Press ZOOM during normal playback or slow motion.

The DVD player magnifies in the center of the picture.

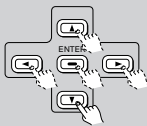
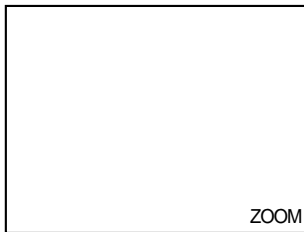

If you press ▲/▼/◀/▶ during zoom playback, the zoom point shifts. If the zoom point reaches the limit, the color of "ZOOM" changes.

If you press CLEAR, the zoom point returns to the center of the picture.

■ To resume normal playback

ZOOM



Press ZOOM during zoom playback.

Notes:

- During still playback, the ZOOM button cannot turn the zoom on or off.
- Zooming does not work on the sub-pictures such as subtitles or menu screens included on DVD video discs.

Selecting the Camera Angle

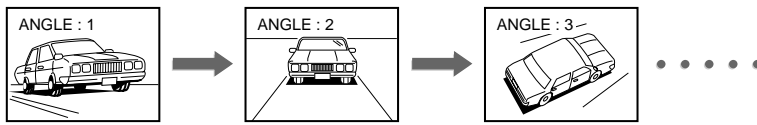

You can select a preferred camera angle to watch a scene.

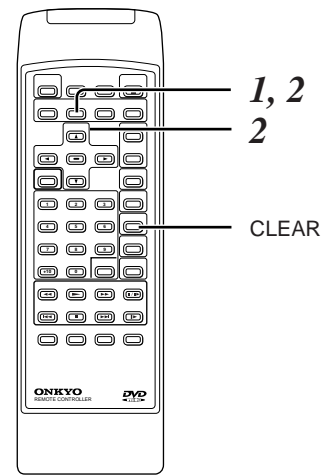

Changing the Camera Angle

If the scene was recorded from multiple angles, you can easily change the camera angle of the scene you are watching.

1

Press ANGLE while playing back a scene recorded from multiple angles.

Press the ANGLE button while the angle icon in the DVD display is flashing.

■ To turn off the angle number indication

CLEAR

Press CLEAR.

2

Press ANGLE or ▲ while the angle number appears on the TV screen.

Each time you press the ANGLE or ▲ button, the camera angle changes.

▼ : Cycles backwards

You can change the camera angle directly by pressing the number buttons corresponding to its angle number instead of using the ▲/▼ buttons.

Notes:

- You can change the camera angle during still playback. The camera angle changes to the new setting when you resume normal playback.
- While playing back a title that contains at least one scene recorded from multiple angles, the angle icon indicator illuminates in the DVD display.

Selecting a Language

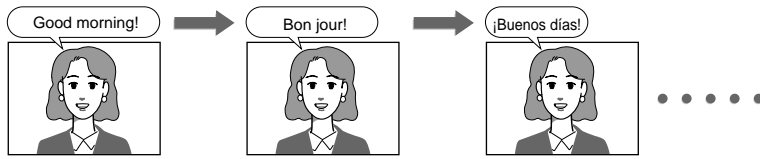

You can select a preferred language.

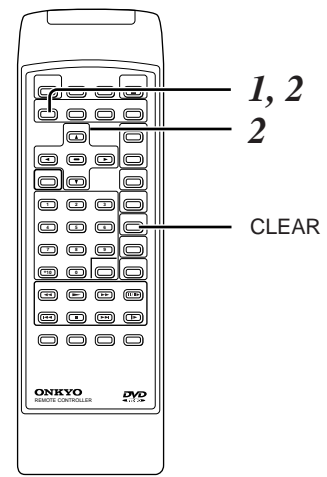

Selecting a Playback Audio Setting

You can select a preferred language and sound recording system from those included on the DVD video disc.

1 Press **AUDIO** during playback.

AUDIO 1 ENG PCM 2CH

Language Position number Recording system Audio channel

Current audio setting appears for about 3 seconds

The abbreviation of the language appears instead of the language name. Refer to the list of languages and their abbreviations. [39](#)

To turn off the audio setting indication

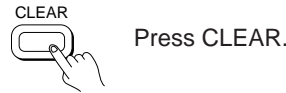

About recording systems

This DVD player uses the Dolby Digital and PCM recording systems and cannot play back DVD video discs recorded in any other recording system.

AC-3 5.1 Channel is displayed as "AC-3 6CH."

Note: Total channels available in AC-3 may vary from 1–6.

2 Press **AUDIO** or **▲** while the audio setting appears on the TV screen.

Each time you press the AUDIO or ▲ button, the audio settings included on the DVD video disc change.

e.g.

AUDIO 1 ENG PCM 2CH

↓

AUDIO 2 FRE AC-3 6CH

↓

AUDIO 3 SPA PCM 2CH

↓

▼ : Cycles backwards

Discs and output sounds

Sound recording system	DVD video discs				Audio CDs	
	Dolby Digital		Linear PCM		Linear PCM 44.1 kHz	
Audio setting on the setting screen (see page 30,31)	AC-3	PCM	AC-3 or PCM	AC-3		PCM
ANALOG AUDIO OUT jacks	–	○	○	○*	○**	○
DIGITAL AUDIO OUT jack	Dolby Digital bitstream	PCM (48 kHz)	PCM (48 kHz)	PCM (48 kHz)	–	PCM (44.1 kHz)

* : 48 kHz processed

** : 96 kHz processed

Notes:

- When you turn on the DVD player or replace a disc, player returns to the initial default setting. [30](#)
- When you select a sound which is not included on the disc, the DVD player plays a prior sound programmed on the disc.

Selecting Subtitles



You can display subtitles on the TV screen and select a preferred subtitle language.

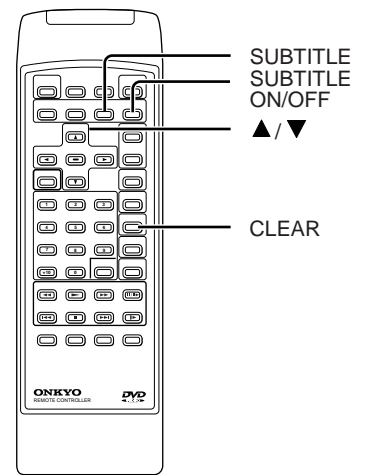

Displaying Subtitles

DVD

You can display subtitles from those included on the DVD video disc.

Press SUBTITLE ON/OFF during playback.

Appears for about 3 seconds

Subtitles

To turn off the subtitles

Press SUBTITLE ON/OFF.

The subtitles disappear.

Appears for about 3 seconds

Notes:

- Some DVD video discs are set to display subtitles automatically, and you cannot turn them off even if you set the subtitle function to off.
- During some scenes, the subtitles may not appear immediately after you press the SUBTITLE ON/OFF button.

Selecting a Subtitle Language

DVD

You can select the subtitle language from those included on the DVD video disc.

1 Press SUBTITLE during playback.

Current subtitle setting appears for about 3 seconds

The abbreviation of the language appears instead of the language name. Refer to the list of languages and their abbreviations.

39

2 Press SUBTITLE or ▲ while the subtitle setting appears on the TV screen.

Each time you press the SUBTITLE or ▲ button, the subtitle languages included on the DVD video disc change.

e.g.

▼ : Cycles backwards

To turn off the subtitle setting indication

Press CLEAR.

Notes:

- When you turn on the DVD player or replace a disc, player returns to the initial default setting. 36
- When you select a subtitle language which is not included on the disc, the DVD player plays a prior language programmed on the disc.
- During some scenes, the subtitles may not appear immediately after you change the subtitle language by pressing the ▲/▼ buttons.

Using the On-Screen Display

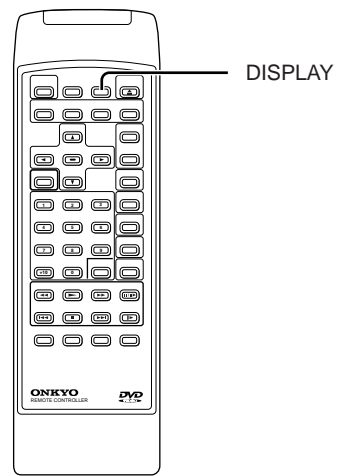

You can view information about a disc and its operational status on the TV screen.

Checking the Operational Status

You can view the current title number, track number, and total playing time of the disc on the TV screen.

Press DISPLAY during stop.

DVD video disc

e.g.

TITLE: 2	1	STOP	Operational status
CHAPTER: 1			

Current title number
First chapter number in the current title

Audio CD

e.g.

TRACK: 1	TOTAL 0:46:30	STOP	Operational status
----------	---------------	------	--------------------

First track number of the disc
Total playing time of the disc

When an audio CD is in the DVD player, the TOTAL indicator and total playing time of the disc appear.

Checking the Remaining Time and Setting Status

You can view the elapsed time, remaining time, and setting status of the disc on the TV screen.

1 Press DISPLAY during playback.

DVD video disc

e.g.

TITLE: 3	2	PLAY	Operational status
CHAPTER: 2			
ELAPSED 0:10:15			Remaining time in the current title
CHAPTER REPEAT			Remaining time in the current chapter

Current title number
Current chapter number
Elapsed time of the current title
Playback mode

The REMAIN indicator and remaining time in the current title appear in the DVD display.

Audio CD

e.g.

TRACK: 3	DISC	PLAY	Operational status
ELAPSED 0:01:20			Remaining time in the current track
TRACK REPEAT			Remaining time of the disc

Current track number
Elapsed time of the current track
Playback mode

The REMAIN indicator and remaining time in the current track appear in the DVD display.

To turn off the on-screen display

Press DISPLAY again.

2 Press DISPLAY again during playback.

When you play back an audio CD, the on-screen display turns off.

e.g.

TITLE: 3	2	PLAY	Current audio setting
CHAPTER: 2			
ELAPSED 0:10:15			Current subtitle setting
AUDIO 1 ENG AC-3 2CH			Current angle setting
SUBTITLE 12 ENG ON			
ANGLE 1			

The abbreviation of the language (e.g. ENG) appears instead of the language name. Refer to the list of languages and their abbreviations.

39

To turn off the on-screen display

Press DISPLAY again.

Customizing the Function Settings

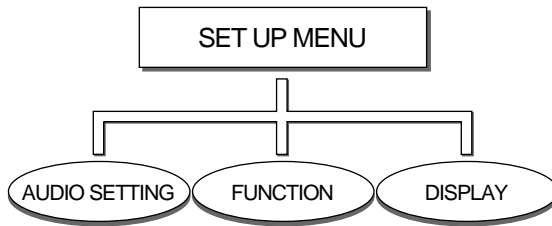
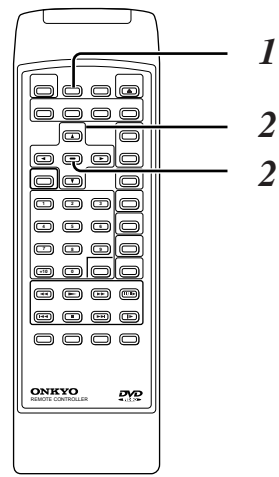

You can change the default settings to customize performance to your preference.

DVD CD

Displaying the SET UP MENU Screen

The SET UP MENU screen asks you to select a setting category from AUDIO SETTING, FUNCTION and DISPLAY. Each selected category will provide you setting details via the succeeding screen.

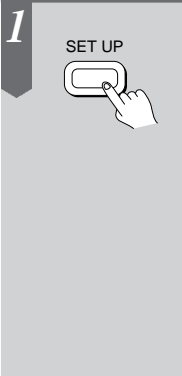

Press SET UP during stop.

The SET UP MENU screen appears.

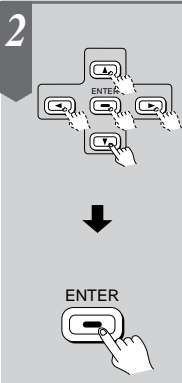
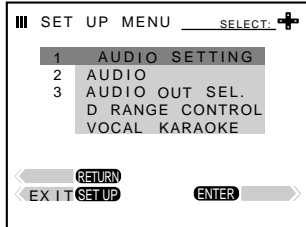

Press ▲/▼ to select the category, then press ENTER.

For the setting details, see page in .

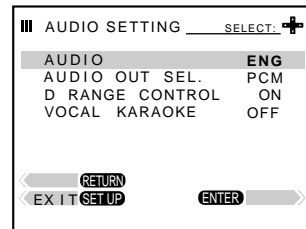
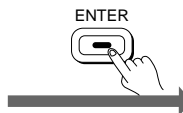
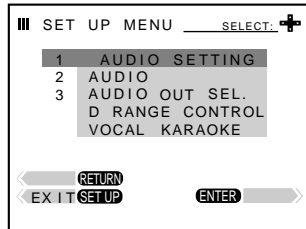

31

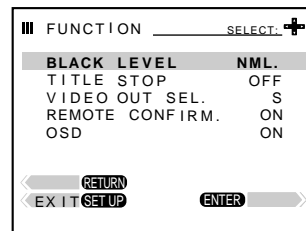
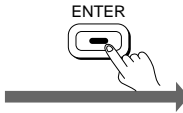
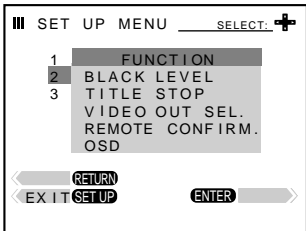

33

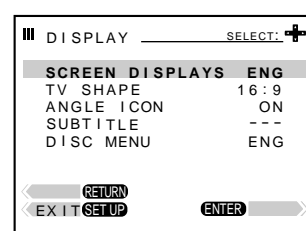
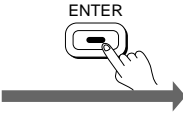
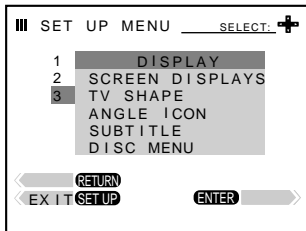

35

Note:

The SET UP MENU screen disappears if you press the SET UP button while it is displayed.

AUDIO SETTING

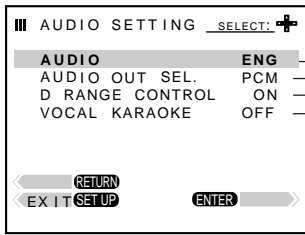

- To select a preferred language from those included on the disc. [25]
- To switch AC-3 (ANALOG OFF) and PCM (ANALOG ON). [11] [12] [13] [14] [25]
- To turn on or off the function that makes faint sounds easier to hear even if you lower the volume in late hours playback.
- To turn on or off the vocal assist in DVD KARAOKE disc playback.

DVD CD

Setting the Audio Sound

After you select AUDIO SETTING on the SET UP MENU screen [30], adjust to your preference.

3

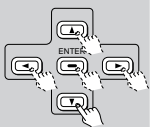

Press ▲/▼ to select the item, then press ENTER.
The setting screen of your selected item appears.

When AUDIO is selected: DVD

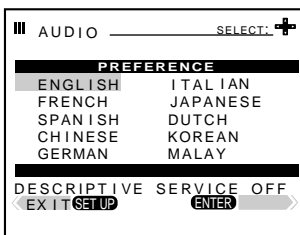

Select a preferred language by pressing ▲/▼/◀/▶, and then press ENTER.

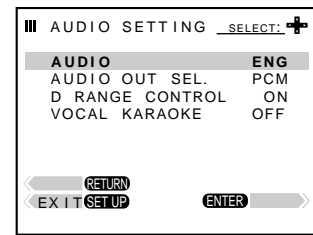
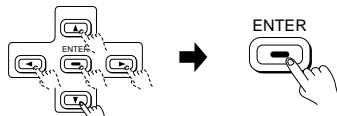

- Some DVD video discs contain special output sound that describes the actions on-screen for visually impaired persons. When you set DESCRIPTIVE SERVICE to "ON" by pressing the AUDIO button, the DVD player automatically plays back this special feature.

- Some DVD video discs may not include your preselected language. In this case, the DVD player automatically plays back the disc's initial language offering.

When AUDIO OUT SEL. is selected: DVD CD

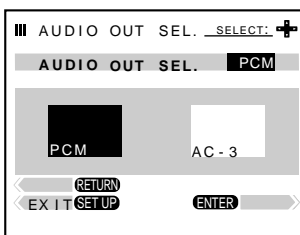

Select the output sound type AC-3 or PCM by pressing ◀/▶, and then press ENTER.

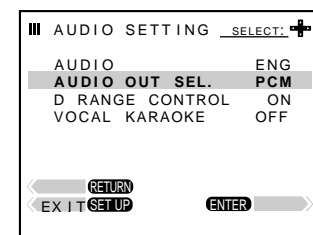
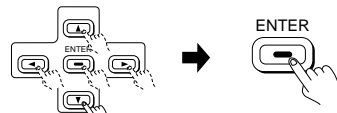

- Select the output sound type according to your system connection. [12] - [15], [27]

When D RANGE CONTROL is selected: DVD

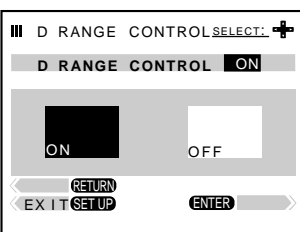

Select ON or OFF by pressing ◀/▶, and then press ENTER.

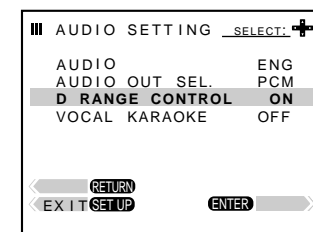
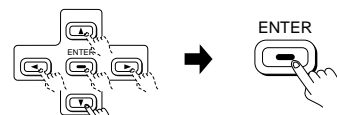

- ON: Dynamic range is reduced.
- OFF: Full dynamic range is maintained.

- This function works on playback of Dolby Digital recorded discs.
- The level of Dynamic Range Reduction may differ depending on the DVD video discs.

Customizing the Function Settings (continued)

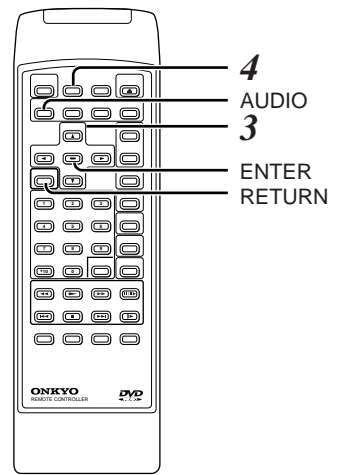

RETURN



: If you press the RETURN button while a menu appears on the screen, you will return to the previous menu screen displayed.

DVD CD

When VOCAL KARAOKE is selected:

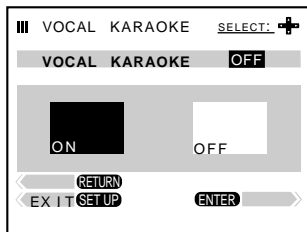

Select ON or OFF by pressing ◀/▶, and then press ENTER.

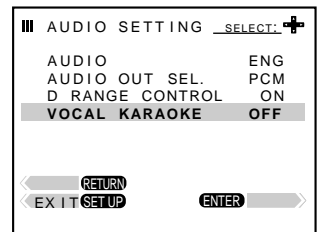
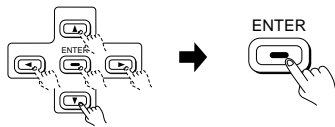

ON: The vocal is output when it is recorded on the disc.
OFF: The vocal is not output.

The vocal assist feature is used during playback of AC-3 encoded DVD KARAOKE discs. This feature allows you to turn off vocal audio tracks, or restore them for background accompaniment.

4

SET UP



Press SET UP.

The setting screen disappears.

FUNCTION

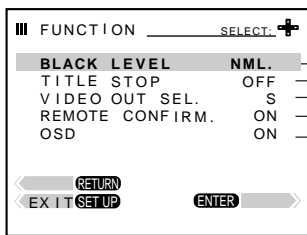

- To select the black level of playback pictures.
- To turn on or off the function that automatically stops playback after playing one title.
- To switch S and COLOR DIFFERENCE. (COMPONENT VIDEO)
- To turn on or off the confirmation beeper for each remote command.
- To turn on or off the operational status display (On-screen display) on the TV screen.

DVD

Setting the Functions

After you select FUNCTION on the SET UP MENU screen **30**, adjust to your preference.

3

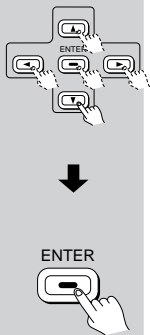

Press **▲/▼** to select the item, then press **ENTER**.

The setting screen of your selected item appears.

When **BLACK LEVEL** is selected: *DVD*

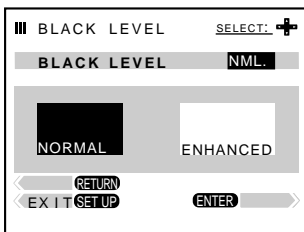

Select a preferred black level by pressing **◀/▶**, and then press **ENTER**.

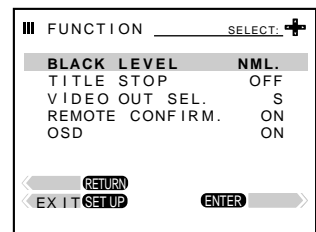
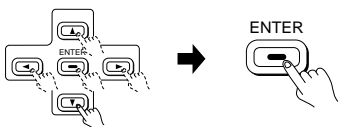

Select the brightness of playback pictures.

NORMAL: Standard black level.

ENHANCED: Expanded black level.

When **TITLE STOP** is selected: *DVD*

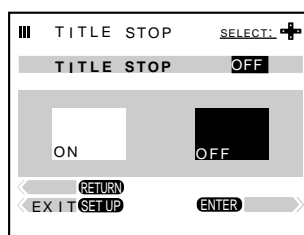

Select **ON** or **OFF** by pressing **◀/▶**, and then press **ENTER**.

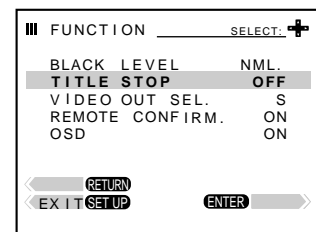
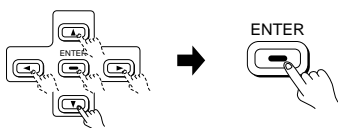

OFF: Player continues after playback of a title is completed.

ON: Player stops after playback of a title is completed.

When **VIDEO OUT SEL.** is selected: *DVD*

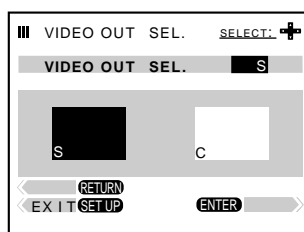

Select **S** or **C** by pressing **◀/▶**, and then press **ENTER**.

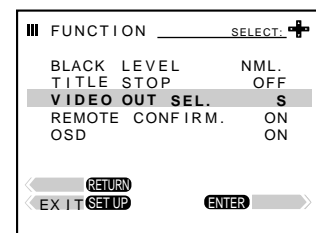
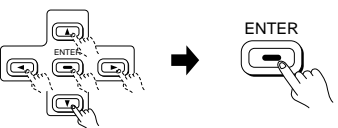

S: Select when the S VIDEO OUT jack is connected.

C: Select when the COMPONENT VIDEO OUT jacks (Y /Cb / Cr) are connected.

- If you select "C" when not using the COMPONENT VIDEO OUT jacks (Y /Cb / Cr), the on-screen display will be lost. In this event, additionally connect the VIDEO OUT jack (yellow). Select the appropriate input on your TV and start this process again.

Customizing the Function Settings (continued)

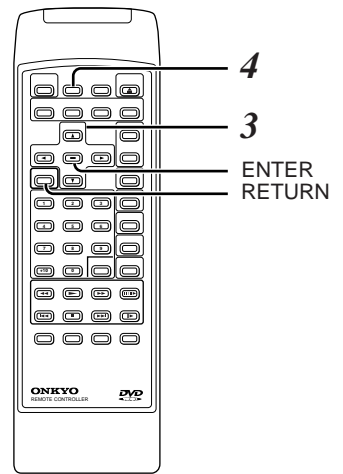

RETURN



If you press the RETURN button while a menu appears on the screen, you will return to the previous menu screen displayed.

DVD CD

When REMOTE CONFIRM. is selected: DVD CD

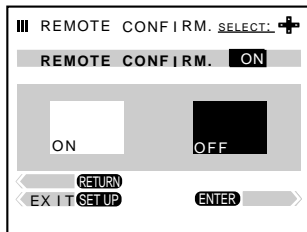

Select ON or OFF by pressing ◀/▶, and then press ENTER.

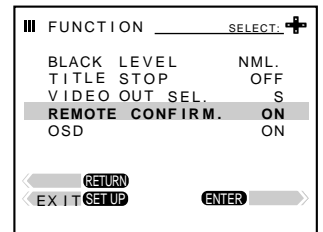
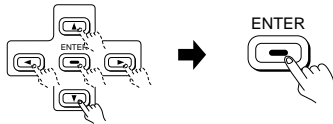

ON: Beeper sounds with each remote operation.
OFF: The beeper does not sound.

When OSD is selected: DVD CD

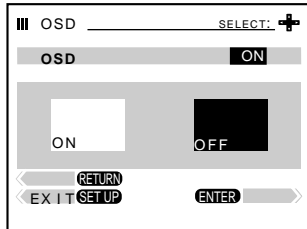

Select ON or OFF by pressing ◀/▶, and then press ENTER.

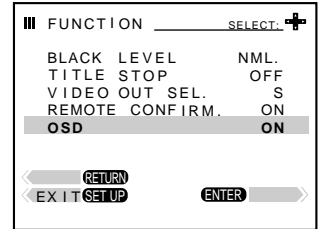
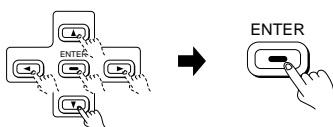

ON: Operational modes are displayed on-screen (e.g. "PLAY")
OFF: Operational modes are not displayed.

4

SET UP



Press SET UP.

The setting screen disappears.

DISPLAY

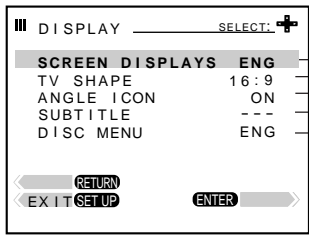

To select the display language.

To select a picture size according to the aspect ratio of your TV.

To display the angle icon indicator on screen.

To select a preferred subtitle language from those included on the DVD video disc. **28**

To select a preferred disc menu language from those included on the DVD video disc.

DVD CD

Setting the Displays

After you select DISPLAY on the SET UP MENU screen **30**, adjust to your preference.

3

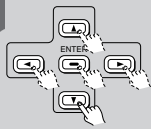

Press **▲/▼** to select the item, then press **ENTER**.
The setting screen of your selected item appears.

When **SCREEN DISPLAYS** is selected: **DVD CD**

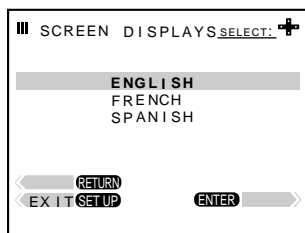

Select a preferred language by pressing **▲/▼**, and then press **ENTER**.

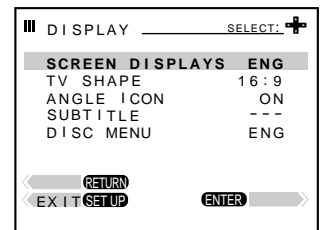
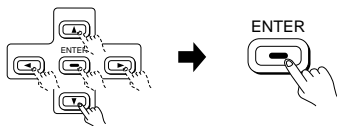

When **TV SHAPE** is selected: **DVD**

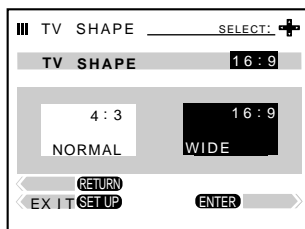

Select your TV type by pressing **◀/▶**, and then press **ENTER**.

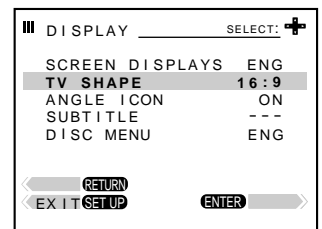
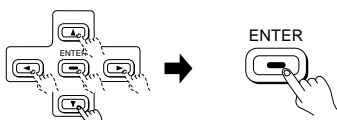

16:9 (WIDE): Select when a 16:9 wide TV is connected.

4:3 (NORMAL): Select when a 4:3 normal TV is connected.

- The displayable picture size is preset on the DVD video disc. Therefore, the playback picture of some DVD video discs may not conform to the picture size you select.
- When you play DVD video discs recorded in the 4:3 picture size only, the playback picture always appears in the 4:3 picture size regardless of the TV shape setting.

If you select 4:3 (NORMAL):

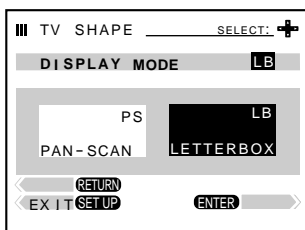

Select **PS** or **LB** by pressing **◀/▶**, and then press **ENTER**.

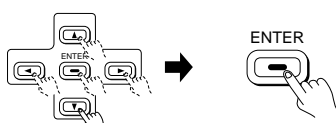

PS (PAN-SCAN):

Displays pictures cropped to fill your TV screen. Either or both sides of the picture are cut off.

LB (LETTER BOX):

Displays theatrical images with masking bars above and below the picture.



PS (PAN-SCAN)



LB (LETTERBOX)

- Pressing the PS/LB button during playback or slow motion playback allows switching of the Pan-scan and the Letterbox temporarily.

The switching of the PS and LB can not be made unless the disc is recorded in a 16:9 and supports the PS/LB switching.

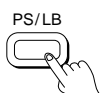

Customizing the Function Settings (continued)

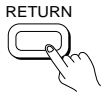
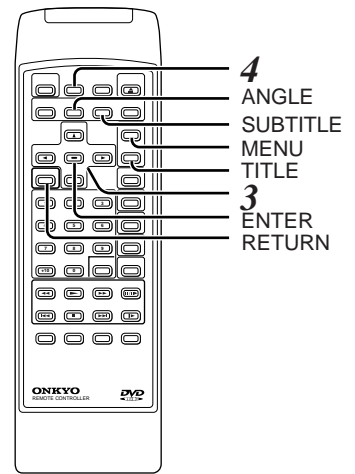

RETURN : If you press the RETURN button while a menu appears on the screen, you will return to the previous menu screen displayed.

DVD CD

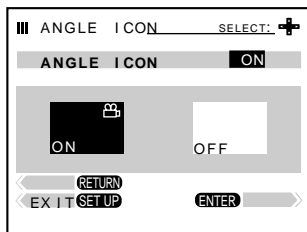

Select ON or OFF by pressing **◀/▶**, and then press **ENTER**.

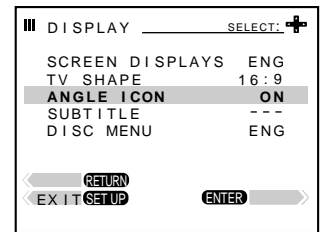
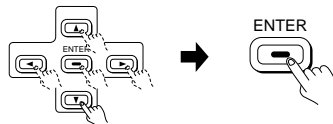

ON: The angle icon automatically appears in white on the TV screen while a scene recorded from multiple angles is played back. When you display the angle number on the screen by pressing the ANGLE button, the angle icon is lit in red.
OFF: The angle icon is not displayed.

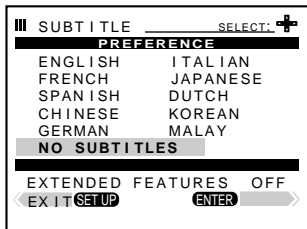

Select a preferred language by pressing **▲/▼/◀/▶**, and then press **ENTER**.

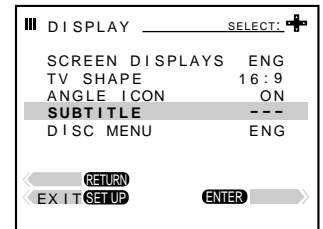
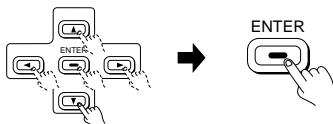

Some DVD video discs contain special subtitles, an enhancement of closed captioning for hearing impaired persons. When you set **EXTENDED FEATURES** to "ON" by pressing the **SUBTITLE** button, the DVD player automatically displays these special subtitles.

- Some DVD video discs may not include your preselected language. In this case, the DVD player automatically displays subtitles consistent with the disc's initial language setting.

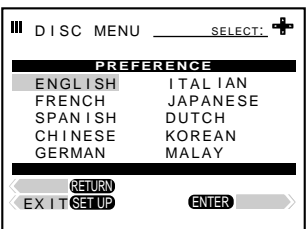

Select a preferred language by pressing **▲/▼/◀/▶**, and then press **ENTER**.

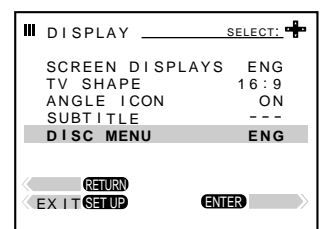
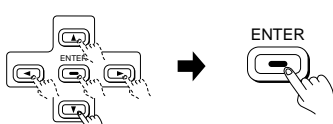

To change the language while a disc is inserted:

- 1) Press the **TITLE** or **MENU** button to display the disc menu.
- 2) Press the **SET UP** button.
If the disc menu has only one language, the display does not appear.
- 3) Press the **SET UP** button repeatedly to select the language. Refer to "Table of Languages". **39**
- 4) Press the **ENTER** button.
The disc menu is displayed in the selected language.



Press SET UP.

The setting screen disappears.

Setting the Parental Lock

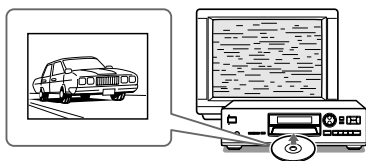

You can use the parental lock function only with DVD video discs equipped with the parental lock function.

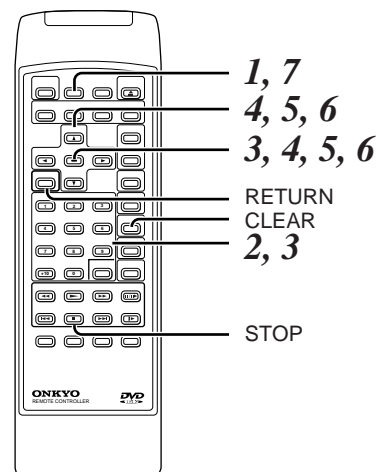

Setting the Parental Lock

DVD video discs equipped with the parental lock function are rated according to their content. The contents allowed by a parental lock level and the way a DVD video disc can be controlled may vary from disc to disc. For example, if the disc allowed you could edit out violent scenes unsuitable for children and replace them with more suitable scenes, or lock out playback of the disc altogether.

1 **SET UP** Press **SET UP** during stop.
The SET UP MENU appears on the TV screen.

2 Press **9** twice.
The following menu appears.

3 Press the number buttons to create a personal 4-digit security code, then press **ENTER**.
e.g. 1 2 3 4

If you make a mistake before pressing the **ENTER** button, press the **CLEAR** button and enter your 4-digit security code again.

4 Press **◀/▶** to select "ON," then press **ENTER**.
The following menu appears.

5 Press **◀/▶** to select the country whose standards were used to rate the DVD video disc, then press **ENTER**.
The following menu appears.

6 Press **▲/▼** to select the parental lock level, then press **ENTER**.
You cannot play back DVD video discs rated higher than the level you selected unless you cancel the parental lock function. For example, when you select level 7, the discs rated higher than level 7 are locked out and cannot be played back.
e.g. When you select USA

When you select "CAN," "CAN7" appears instead.

The parental lock level is equivalent to the following USA movie ratings.

LEVEL 7: NC-17	LEVEL 3: PG
LEVEL 6: R	LEVEL 1: G
LEVEL 4: PG 13	

The parental lock levels for "CAN" (Canada) are included for future use. Check the appropriate parental lock level when you buy a DVD video disc equipped with the parental lock function in the future.

7 Press **SET UP**.
The SET UP MENU disappears.

Setting the Parental Lock (continued)

RETURN



If you press the RETURN button while a menu appears on the screen, you will return to the previous menu screen displayed.

DVD

■ To change the parental lock level

You can change the parental lock level by following the steps in “Setting the Parental Lock.”

In step 3, press the **number buttons** to enter your 4-digit security code, then continue to step 4.

If you make a mistake, press the **CLEAR** button and enter the correct 4-digit security code.

■ To change your 4-digit security code

You can change your 4-digit security code.

- 1 Follow steps 1 and 2 in “Setting the Parental Lock.”
- 2 Press the **STOP** button four times while the security code menu appears on the TV screen.



The 4-digit security code is cleared.

- 3 Press the **number buttons** to create a new 4-digit security code, then press the **ENTER** button.
- 4 Complete steps 4 to 7 in “Setting the Parental Lock.”

■ To cancel the parental lock function

- 1 Follow steps 1 and 2 in “Setting the Parental Lock.”
- 2 Press the **number buttons** to enter your 4-digit security code, then press the **ENTER** button.

If you make a mistake, press the **CLEAR** button and enter the correct 4-digit security code.

- 3 Press **◀/▶** to select “OFF,” then press the **ENTER** button.

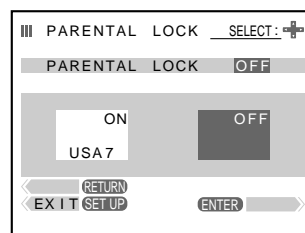

The SET UP MENU appears again.

- 4 Press the **SET UP** button.

The SET UP MENU disappears, and the parental lock function is cancelled.

Note:

DVD video discs may or may not respond to the parental lock settings. Make sure this function works with your DVD video discs.

Table of Languages

Table of Languages and Their Abbreviations

Abbreviation of the Language	Language	Abbreviation of the Language	Language	Abbreviation of the Language	Language	Abbreviation of the Language	Language
—	No alternate language	EO	Esperanto	LN	Lingala	SL	Slovenian
CHI	Chinese	ET	Estonian	LO	Laotian	SM	Samoan
DUT	Dutch	EU	Basque	LT	Lithuanian	SN	Shona
ENG	English	FA	Persian	LV	Latvian, Lettish	SO	Somali
FRE	French	FI	Finnish	MG	Malagasy	SQ	Albanian
GER	German	FJ	Fiji	MI	Maori	SR	Serbian
ITA	Italian	FO	Faroese	MK	Macedonian	SS	Siswati
JPN	Japanese	FY	Frisian	ML	Malayalam	ST	Sesotho
KOR	Korean	GA	Irish	MN	Mongolian	SU	Sundanese
MAY	Malay	GD	Scottish Gaelic	MO	Moldavian	SV	Swedish
SPA	Spanish	GL	Galician	MR	Marathi	SW	Swahili
AA	Afar	GN	Guarani	MT	Maltese	TA	Tamil
AB	Abkhazian	GU	Gujarati	MY	Burmese	TE	Telugu
AF	Afrikaans	HA	Hausa	NA	Nauru	TG	Tajik
AM	Amharic	HI	Hindi	NE	Nepali	TH	Thai
AR	Arabic	HR	Croatian	NO	Norwegian	TI	Tigrinya
AS	Assamese	HU	Hungarian	OC	Occitan	TK	Turkmen
AY	Aymara	HY	Armenian	OM	(Afan) Oromo	TL	Tagalog
AZ	Azerbaijani	IA	Interlingua	OR	Oriya	TN	Setswana
BA	Bashkir	IE	Interlingue	PA	Panjabi	TO	Tongan
BE	Belorussian	IK	Inupiak	PL	Polish	TR	Turkish
BG	Bulgarian	IN	Indonesian	PS	Pashto, Pushto	TS	Tsonga
BH	Bihari	IS	Icelandic	PT	Portuguese	TT	Tatar
BI	Bislama	IW	Hebrew	QU	Quechua	TW	Twi
BN	Bengali, Bangla	JI	Yiddish	RM	Rhaeto-Romance	UK	Ukrainian
BO	Tibetan	JW	Javanese	RN	Kirundi	UR	Urdu
BR	Breton	KA	Georgian	RO	Rumanian	UZ	Uzbek
CA	Catalan	KK	Kazakh	RU	Russian	VI	Vietnamese
CO	Corsican	KL	Greenlandic	RW	Kinyarwanda	VO	Volapük
CS	Czech	KM	Cambodian	SA	Sanskrit	WO	Wolof
CY	Welsh	KN	Kannada	SD	Sindhi	XH	Xhosa
DA	Danish	KS	Kashmiri	SG	Sango	YO	Yoruba
DZ	Bhutani	KU	Kurdish	SH	Serbo-Croatian	ZU	Zulu
EL	Greek	KY	Kirghiz	SI	Singhalese		
		LA	Latin	SK	Slovak		

Notes on Discs

This section shows you how to handle, clean, and store discs.

On Handling Discs

- Do not touch the playback side of the disc.

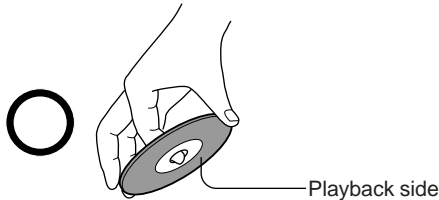

- Do not attach paper or tape to discs.



On Cleaning Discs

- Fingerprints and dust on the disc cause picture and sound deterioration. Wipe the disc from the center outwards with a soft cloth. Always keep the disc clean.

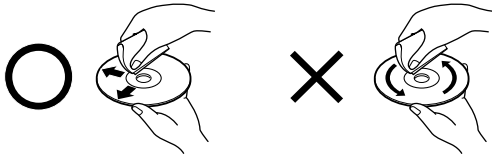



- If you cannot wipe off the dust with a soft cloth, wipe the disc lightly with a slightly moistened soft cloth and finish with a dry cloth.
- Do not use any type of solvent such as thinner, benzene, commercially available cleaners or antistatic spray for vinyl LPs. It may damage the disc.

On Storing Discs

- Do not store discs in a place subject to direct sunlight or near heat sources.
- Do not store discs in places subject to moisture and dust such as a bathroom or near a humidifier.
- Store discs vertically in a case. Stacking or placing objects on discs outside of their case may cause warping.



About This Instruction Manual

This instruction manual explains the basic instructions of this DVD player. Some DVD video discs are produced in a manner that allows specific or limited operation during playback. As such, the DVD player may not respond to all operating commands. Refer to instruction notes of discs.

“” may appear on the TV screen during operation. White “” means that the operation is not permitted by the DVD player; red “” by the operation is not permitted by DVD video disc.

Playable Discs

This DVD player can play back the following discs.

	Disc mark	Contents	Disc size	Maximum playback time
DVD video discs		Audio + Video (moving pictures)	12 cm	Approx. 4 hours (single sided disc) Approx. 8 hours (double sided disc)
			8 cm	Approx. 80 minutes (single sided disc) Approx. 160 minutes (double sided disc)
Audio CDs		Audio	12 cm	74 minutes
			8 cm (CD single)	20 minutes

You cannot play back discs other than those listed above.

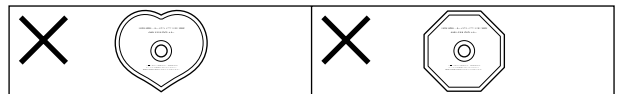

This DVD player uses the NTSC color system, and cannot play back DVD video discs recorded in any other color system (PAL, SECAM, etc.).



Avoid using heart-shaped or octagonal discs. Playing irregularly shaped discs may damage the internal mechanism of the DVD player.

Do not use discs on which adhesive from adhesive tape or a disc label (if it is a rental disc) remains. Otherwise, you may not be able to eject the discs or the DVD player may become inoperative.

Notes on Region Numbers

The region number of this DVD player is 1. If region numbers, which stand for their playable area, are printed on your DVD video disc and you do not find  or , disc playback will not be allowed by the player. (In this case, the DVD player displays the message.)

Notes on Copyright

It is forbidden by law to copy, broadcast, show, broadcast on cable, play in public, and rent copyrighted material without permission.

DVD video discs are copy protected, and any recordings made from these discs will be distorted.

This product incorporates copyright protection technology that is protected by method claims of certain U.S. patents and other intellectual property rights owned by Macrovision Corporation and other rights owners. Use of this copyright protection technology must be authorized by Macrovision Corporation, and is intended for home and other limited viewing uses only unless otherwise authorized by Macrovision Corporation. Reverse engineering or disassembly is prohibited.

Before Calling Service Personnel

Check the following guide for the possible cause of a problem before contacting service.

Symptoms and Correction

Symptom	Cause	Correction	Page
No power.	The power plug is disconnected.	Connect the power plug into the wall outlet securely.	12,13
No picture.	• The TV is not set to receive DVD signal output.	• Select the appropriate video input mode on the TV so the picture from the DVD player appears on the TV screen.	16
	• The video cable is not connected securely.	• Connect the video cable into the jacks securely.	12-15
No sound.	• The equipment connected with the audio cable is not set to receive DVD signal output.	• Select the correct input mode of the audio receiver so you can listen to the sound from the DVD player.	16
	• The audio cables are not connected securely.	• Connect the audio cable into the jacks securely.	12-15
	• The power of the equipment connected with the audio cable is turned off.	• Turn on the equipment connected with the audio cable.	–
	• The setting of output sound type is not correct.	• Set the audio setting correctly.	30,31
The playback picture has occasional distortion.	• The disc is dirty.	• Eject the disc and clean it.	40
	• It is in fast forward or fast reverse playback.	• Sometimes a small amount of picture distortion may appear. This is not a malfunction.	–
Brightness is unstable or noises are produced on playback pictures.	• The copy protection's effect.	• Connect the DVD player to the TV directly.	12
The DVD player does not start playback.	• No disc is inserted.	• Insert a disc. (Check that the DVD or audio CD indicator in the DVD display is lit.)	16
	• An unplayable disc is inserted.	• Insert a playable disc. (Check the disc type and color system.)	40
	• The disc is placed upside down.	• Place the disc with the playback side down.	16
	• The disc is not placed within the guide.	• Place the disc on the disc tray correctly inside the guide.	16
	• The disc is dirty.	• Clean the disc.	40
	• A menu is on the TV screen.	• Press the SET UP button to turn off the menu screen.	–
	• The parental lock function is set.	• Cancel the parental lock function or change the parental lock level.	37, 38
Buttons do not work.	Power supply fluctuations or other abnormalities such as static electricity may interrupt correct operation.	Turn the power on or off with the POWER button. Or disconnect the power plug and insert it into the wall outlet again.	–
The remote control does not work properly.	• The remote control is not pointed at the remote sensor of the DVD player.	• Point the remote control at the remote sensor of the DVD player.	11
	• The remote control is too far from the DVD player.	• Operate the remote control within about 5 m.	11
	• The batteries in the remote control are exhausted.	• Replace the batteries with new ones.	11

Specifications

DVD Player/Outputs/Supplied Accessories

DVD Player

Power supply	AC 120 V, 60 Hz AC 120 - 240 V, 50/60 Hz
Power consumption	20 W
Weight	4.5 kg
External dimensions	435 × 121 × 306 mm (W/H/D)
Signal system	Standard NTSC
Laser	Semiconductor laser, wavelength 650 nm
Frequency range (digital audio)	DVD linear sound : 48 kHz sampling 4Hz to 22 kHz 96 kHz sampling 4 Hz to 44kHz Audio CD : 4 Hz to 20 kHz
Signal-to-noise ratio (digital audio)	More than 96 dB (EIAJ)
Audio dynamic range (digital audio)	More than 96 dB (EIAJ)
Harmonic distortion (digital audio)	Less than 0.006 %
Wow and flutter	Below measurable level (less than ±0.001 % (W.PEAK)) (EIAJ)
Operating conditions	Temperature: 5 °C to 35 °C (41 to 95 Degree), Operation status: Horizontal

Outputs

Video output	1.0 V (p-p), 75 Ω, negative sync., pin jack × 1
S video output	(Y) 1.0 V (p-p), 75 Ω, negative sync., Mini DIN 4-pin × 1 (C) 0.286 V (p-p), 75 Ω
Color difference output	(Y) 1.0 V (p-p), 75 Ω, negative sync., pin jacks × 1 (Cr)/(Cb) 0.7 V (p-p), 75 Ω
Audio output (optical audio)	Optical connector × 1
Audio output (digital audio)	0.5 V (p-p), 75 Ω, pin jack × 1
Audio output (analog audio)	2.0 V (rms), 470 Ω, pin jacks (L,R) × 1
Headphone terminal	32 Ω (30mW), Impedance: more than 8 Ω

Supplied Accessories

S video cable	1
Audio/video cable	1
Remote control (RC-375DV)	1
Batteries (AA)	2
RI cable	1
CV plug (120 - 240 V model only)	1

- Designs and specifications are subject to change without notice.

Memo

A large rectangular frame with a solid gray border, containing 15 horizontal dashed lines for writing.

ONKYO CORPORATION

Sales & Product Planning Div.: 2-1, Nisshin-cho, Neyagawa-shi, OSAKA 572-8540, JAPAN
Tel: 0720-31-8111 Fax: 0720-33-5222

ONKYO U.S.A. CORPORATION

200 Williams Drive, Ramsey, N.J. 07446, U.S.A.

Tel: 201-825-7950 Fax: 201-825-8150 E-mail: onkyo@onkyousa.com

ONKYO EUROPE ELECTRONICS GmbH

Industriestrasse 20, 82110 Germering, GERMANY

Tel: 089 84 93 20 Fax: 089 84 93 226 E-mail: info@onkyo.de

ONKYO EUROPE FRANCE BRANCH

Domaine Technologique de Saclay 4, Rue René Razel, SACLAY-91892

ORSAY CEDEX, FRANCE Tel: (1) 69 33 14 00 Fax: (1) 69 41 35 84

ONKYO CHINA LIMITED

Units 1111-1112 Metroplaza Tower II, 223 Hing Fong Road Kwai Chung,
N.T., HONG KONG Tel: 852 2429 3118 Fax: 852 2428 9039

