

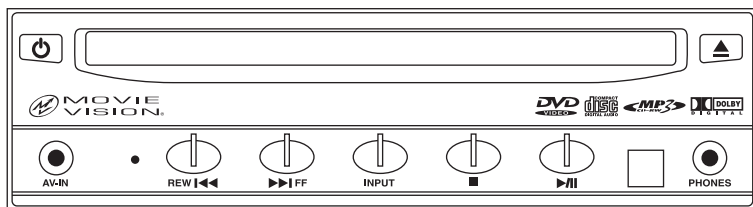

# Compact Mobile DVD Player Owner's Manual



**Model: MV-DVD-PL2**

For operational or technical assistance, after reading this manual,  
please call us toll free at (800) 638-3600 or visit [www.magnadyne.com](http://www.magnadyne.com).

## Contents

Safety Information . . . . .	2-3	Remote Control . . . . .	9
Features . . . . .	3	Remote Control Functions . . . . .	10
Disc Handling Notes . . . . .	4	Basic Operations . . . . .	11-14
Installation . . . . .	5	System Setup . . . . .	15-17
Electric Connection . . . . .	6-7	Troubleshooting . . . . .	18
Front Panel Functions . . . . .	8	Replacement Parts . . . . .	19
Specifications . . . . .	8	Warranty . . . . .	20

## Safety Information

### Caution:

MOBILE DVD PLAYER IS A CLASS I LASER PRODUCT. HOWEVER THIS MOBILE DVD PLAYER USES A VISIBLE/INVISIBLE LASER BEAM WHICH COULD CAUSE HAZARDOUS RADIATION EXPOSURE IF DIRECTED. BE SURE TO OPERATE THE MOBILE DVD PLAYER CORRECTLY AS INSTRUCTED. USE OF CONTROLS OR ADJUSTMENTS OR PERFORMANCE OF PROCEDURES OTHER THAN THOSE SPECIFIED HEREIN MAY RESULT IN HAZARDOUS RADIATION EXPOSURE. DO NOT OPEN COVERS AND DO NOT REPAIR YOURSELF. REFER SERVICING TO QUALIFIED PERSONNEL.

### Warning:

- TO REDUCE THE RISK OF FIRE OR ELECTRIC SHOCK, DO NOT EXPOSE THIS EQUIPMENT TO RAIN OR MOISTURE.
- TO REDUCE THE RISK OF FIRE OR ELECTRIC SHOCK, AND ANNOYING INTERFERENCE, USE ONLY THE RECOMMENDED ACCESSORIES.

This product incorporates copyright protection technology that is protected by method claims of certain U.S. patents and other intellectual property rights owned by Magnadyne Corporation and other rights owners. Use of this copyright protection technology must be authorized by Magnadyne Corporation, and is intended for home and other limited viewing uses only unless otherwise authorized by Magnadyne Corporation. Reverse engineering or disassembly is prohibited.

### Region Management Information:

This Mobile DVD Player is designed and manufactured to respond to the Region Management Information that is recorded on a DVD disc. If the Region number described on the DVD disc does not correspond to the Region number of this Mobile DVD Player, this Mobile DVD Player cannot play this disc.

## Using this Product Safely

### Operation

Before installation and use of this DVD player, please read this manual completely.

### Driving

Be aware of road and traffic conditions, keep the volume at a low level.

### Car Washing

Do not expose the product to water or excessive moisture. This could cause electrical shorts, fire or other damage.

### Parking

Parking in direct sunlight can produce very high temperatures inside your vehicle. Give the car interior a chance to cool down before starting playback.

### Proper Power Supply

This product is designed to operate with a 12 Volt DC, negative ground battery system.

### Protecting the Disc Mechanism

Avoid inserting any foreign objects into the slot of this player. Failure to observe this precaution may cause malfunction of this unit.

### Repairs

Contact our customer service representatives. Do not attempt to disassemble or adjust this product yourself.

### Installation



The unit should be installed in a horizontal or vertical position.

## DVD Player Features

- This DVD player provides multi-media, high resolutions images with high-quality surround-sound effects.
- Supported formats include: DVD, DVD-R, CD, CD-R/RW, MP3 and JPEG Picture.
- Multi-Lingual On-Screen Display Menu
- Last Position Playback Memory
- Front Panel Second Source A/V Inputs.
- Multi-Image ratio, which enables the DVD player to match different TV screens.
- Multi-Angle. Users can select different viewing options (if this feature is included on the disc).
- Anti-Shock Buffer
- Wireless Remote Control with External IR Eye.

## Disc Handling Notes

### Disc Formats Supported by this Player:

	<b>DVD</b> 12 cm disc (Single-sided disc only)
	<b>CD</b> 12 cm disc
	<b>MP3</b> 12 cm disc

### Discs which cannot be played with this player:

- DVD-ROM
- DVD-R/DVD-RAM
- CDV
- CD-G

### Disc Handling

- Dirt, dust, scratches and warping disc will cause non operation.
- Do not place stickers on disc or scratch disc.
- Do not warp discs.
- A disc should always be kept in its case when not in use to prevent damage.
- Do not place discs in the following places:
  1. Direct sunlight.
  2. Dirty, dusty and damp areas.
  3. Near car heaters.
  4. Car seats or dashboard.

### Disc Cleaning

Use a dry soft cloth to wipe the surface. If the disc is quite dirty, use a soft cloth slightly moist with isopropyl (rubbing) alcohol. Never use solvents such as benzine, thinner or conventional record cleaners as they may mar the surface of the disc.

**Note:** A disc may become somewhat scratched (although not enough to make it unusable) depending on handling and conditions in the usage environment.

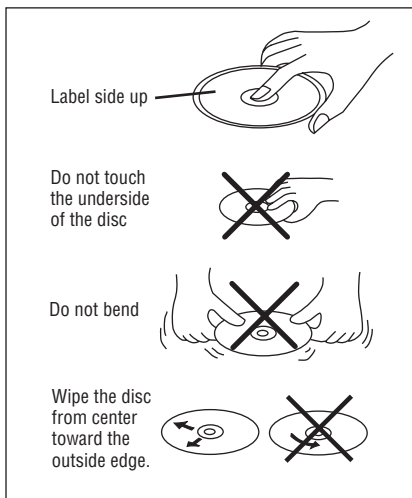

### Preparing New Discs with Rough Spots

A new disc may have rough edges on its inside and outside edges. If a disc with rough edges is used, the proper setting will not be performed and the player will not play the disc. Therefore, remove the rough edges in advance by using a ball point pen or pencil as shown. To do this, press the side of the pen or pencil against the inside and outside edges of the disc.

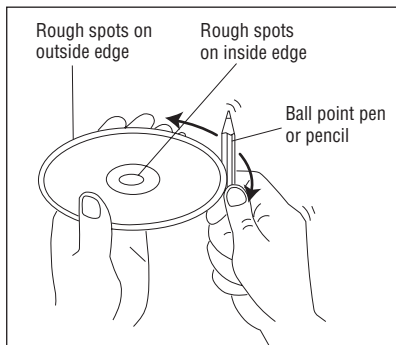

## Installation

### Notes:

- With the screws provided, attach the brackets on both sides of unit as shown in the illustration below.
- Install the unit as a floor mount or underdash mount with the screws provided.

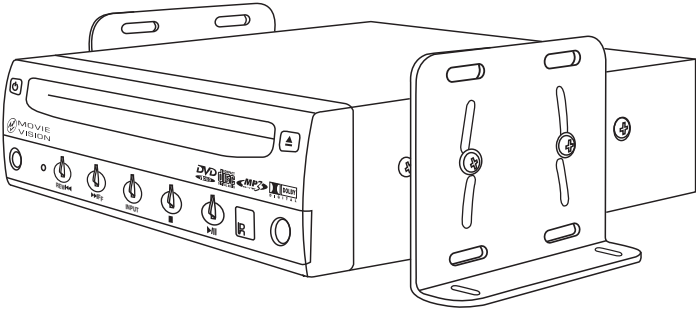

**Floor Mount**

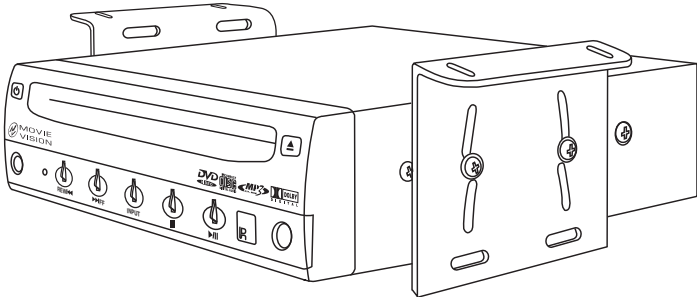

**Underdash Mount**

# Electric Connection

## Connecting to a Monitor

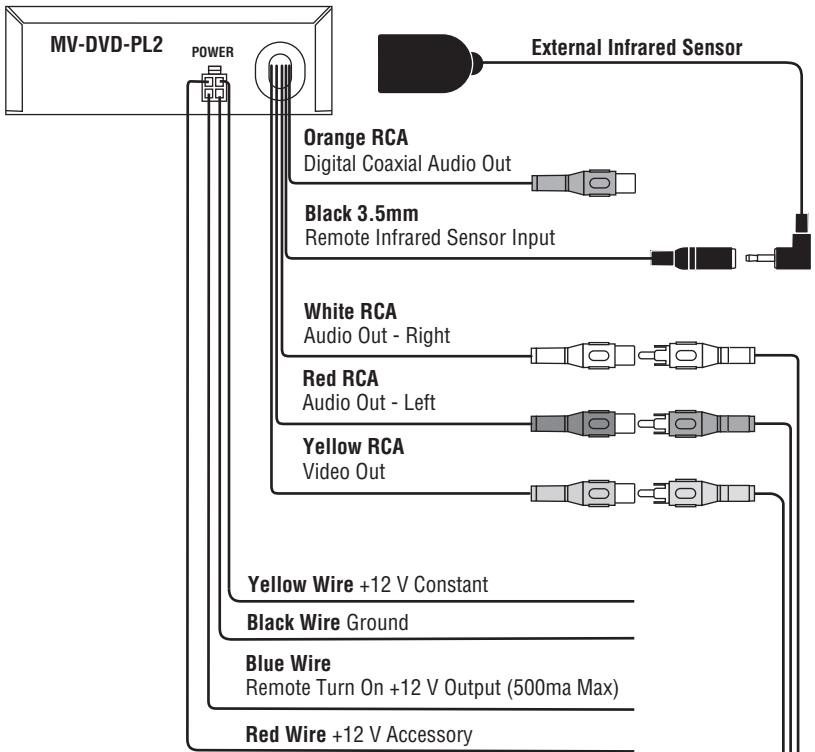

## MovieVision Pod MV780

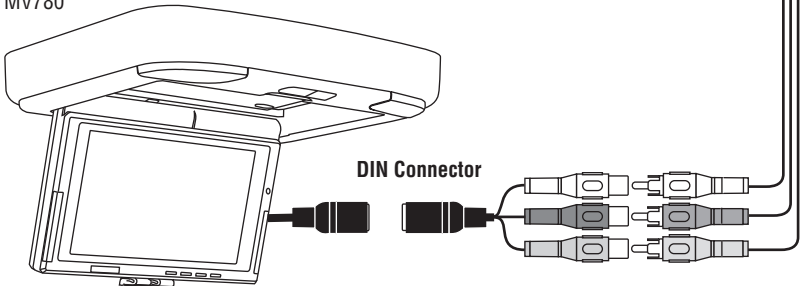

# Electric Connection

Connecting to a MovieVision System that uses a Separate Power Module as the Only Source

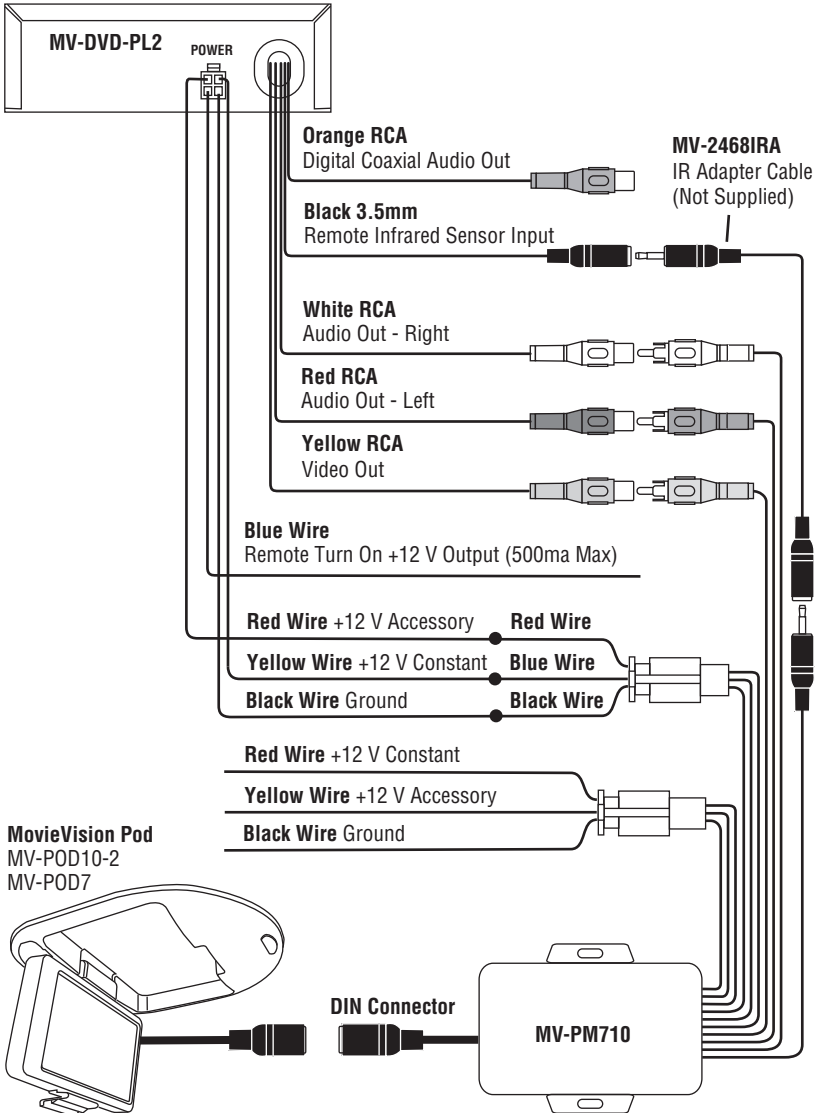

## Front Panel Functions

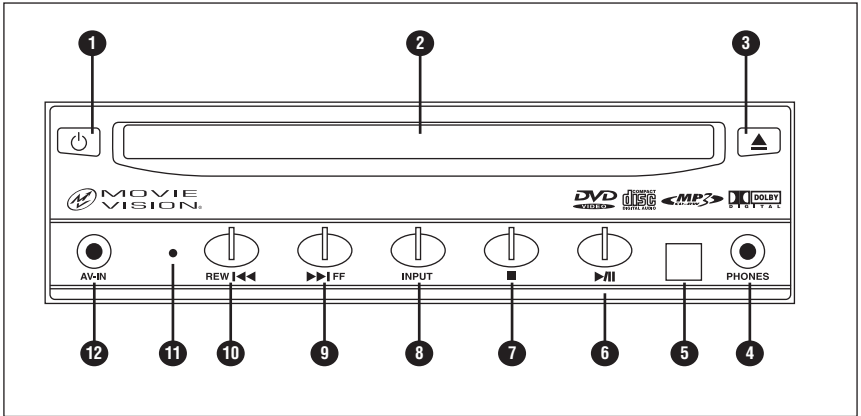

1. **POWER**
2. **DISC SLOT**
3. **EJECT**
4. **HEADPHONE CONNECTION**
5. **REMOTE INFRARED SENSOR**
6. **PLAY / PAUSE**
7. **STOP**
8. **INPUT (SELECT)**
9. **FF / NEXT CHAPTER**
10. **REW / PREVIOUS CHAPTER**
11. **RESET**
12. **AV IN**

## Specifications

Power Voltage:	12V DC
Power Consumption:	15W
Video Format:	MPEG1, MPEG2
Audio Format:	Dolby Digital
Signal Output:	Video Signal: NTSC or PAL
Video:	1.0Vp-p
Audio:	Mix Stereo 2.0Vp-p
Output Interface:	RCA Output, Coaxial Digital Output
Frequency Response:	DVD: 20 Hz-20 KHz
Weight:	1.6 kg (including package)
Dimensions:	160 x 44 x 165 (mm)



## Remote Control

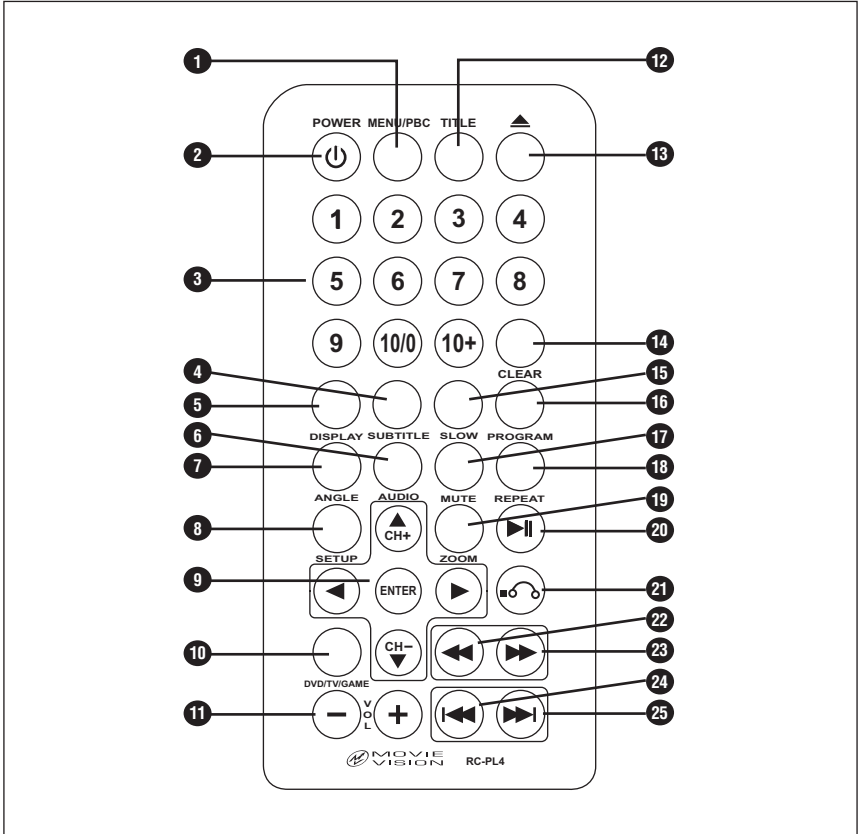

## Preparing/Using the Remote Control

### Preparing the Remote Control

Inserting the Batteries:

1. Open the battery compartment cover.
2. Insert the 2 AAA size batteries. Make sure that the (+) positive and (-) negative terminals of the batteries are oriented correctly.
3. Close the battery compartment cover.

### Using the Remote Control

Point the remote control towards the remote infrared sensor on the front panel of the DVD Player.

## Remote Control Functions

- 1. MENU/PBC:** Selects scenes available on the disc.
- 2. POWER:** Turns the unit "On" or "Off".
- 3. NUMBER:** Numeric buttons used to enter number of desired track.
- 4. SUBTITLE:** Changes the subtitle language on multi-subtitle language discs.
- 5. DISPLAY:** Displays statistical disc information during playback.
- 6. AUDIO:** Changes the language on multi-language discs.
- 7. ANGLE:** Changes the view angle on multi-angle discs.
- 8. SETUP:** Displays the setup menu.
- 9. ENTER/SELECT:** Enter confirms the selected item. The four select buttons moves the cursor to select items.
- 10. DVD/TV/GAME:** Displays the auxiliary input.
- 11. VOLUME:** Decreases or increases the volume level.
- 12. TITLE:** Displays the title menu that is stored on the disc.
- 13. EJECT:** Ejects the disc.
- 14. CLEAR:** Cancels the entered number.
- 15. SLOW:** Plays DVD's slow forward/reverse.
- 16. PROGRAM:** Plays CD tracks in the order programmed.
- 17. MUTE:** Mutes the sound.
- 18. REPEAT:** Repeats play of chapters, titles and discs.
- 19. ZOOM:** Enlarges or reduces size of picture.
- 20. PLAY/PAUSE:** Starts/Pauses play.
- 21. STOP:** Stops play.
- 22. BACKWARD:** Plays disc fast backwards.
- 23. FORWARD:** Plays disc fast forward.
- 24. PREVIOUS:** Skips to previous track/chapter.
- 25. NEXT:** Skips to next track/chapter.

### Loading a Disc

1. Turn the car ignition "On" to the accessory position.
2. Press the **POWER** button.
3. Insert the disc with printed side facing up into the disc slot.
4. The disc will then load, and disc playback will start automatically.

### Ejecting a Disc

Press the **EJECT** button to eject the disc from the DVD player (remove the disc or it will reload automatically). Push **EJECT** again to reload the disc.

### Playing a Disc

Press **PLAY/PAUSE** to start disc playback.

### Pausing a Disc

Press **PLAY/PAUSE** during disc playback to stop play temporarily. Press **PLAY/PAUSE** again to resume normal playback speed.

Note: When the DVD player is in slow play, fast forward or fast reverse mode, push **PLAY/PAUSE** button to resume normal playback speed.

### Volume Control

Press the **VOL+** button to increase the volume level. To decrease the volume level push the **VOL-** button.

### Muting the Sound Level

To lower the sound level while disc play continues press the **MUTE** button on the remote control. Press **MUTE** again to resume sound to the previous level.

### Remote Sensor

Depending on the placement of your DVD player, you can control the DVD functions either by pointing the remote control directly at the DVD player or at the external remote sensor.

### Last Memory

After the engine is turned "Off" or the unit is powered "Off", the unit will resume play at the point play was interrupted when the player is turned back on again.

### Fast Forward

While a disc is playing, push the **FORWARD** button to play fast forward. With each press of the button you will scroll through these five fast forward speeds: 2x, 4x, 8x, 16x and 32x. When maximum speed is reached, pressing **FORWARD** again will return play to normal speed.

### Fast Backward

While a disc is playing, push the **BACKWARD** button to play fast backward. With each press of the button you will scroll through these five fast backward speeds: 2x, 4x, 8x, 16x and 32x. When maximum speed is reached, pressing **BACKWARD** again will return play to normal speed.

### Slow Play

While the disc is playing, push **SLOW** to play disc in slow motion. There are four slow forward speeds and four slow backwards speeds:

**▶1/2 ▶1/4 ▶1/8 ▶1/16 ◀1/2 ◀1/4 ◀1/8 ◀1/16**

Push **SLOW** once, and the speed changes by one increment. Continue pushing **SLOW** until disc play returns to normal speed.

### Stopping Play

While the disc is playing, push the  **STOP** button to stop play temporarily. Press

**▶|| PLAY/PAUSE** to resume play at the point play was interrupted, or press the **STOP** button again to completely stop disk playback. Press **PLAY/PAUSE** to start playback from the beginning of disc.

### Scene Selection

With the DVD in playback mode, follow these steps:

1. Push **MENU/PBC**. The different scenes available on the disc will be displayed.
2. Use the **◀ ▶ ▲ ▼ SELECTION** buttons to select a desired scene.
3. Push **ENTER** to confirm the selection.

The disc may also contain submenus. To make a submenu selection use the **SELECTION** buttons. Then push the **ENTER** button to confirm the selection.

### Skipping Tracks/Chapters

Push the **▶▶ NEXT** button to skip to next track/chapter on a disc. Push the **◀◀ PREVIOUS** button to skip to previous track/chapter on a disc.

### Selecting a Specific Track

For those discs with direct track numbers, use the **NUMBER** buttons to select desired track:

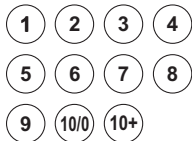

When the track is greater than 9, push the **10+** button, then the relative **NUMBER** button.

### Title Selection

If the DVD has multiple titles recorded on the disc, a preferred title can be selected from the title menu to start playback.

1. Press **TITLE** during playback. The title menu is then displayed.
2. Use the **◀ ▶ ▲ ▼ SELECTION** buttons to select a preferred title.
3. Confirm selection by the pressing the **ENTER** button.

The disc may also contain submenus. Use the **SELECTION** buttons to make a submenu selection. Then push the **ENTER** button to confirm the selection.

### Select Subtitle Language

(Only available on multi-subtitle language discs). Press **SUBTITLE** during playback to display current subtitle language. Continue pressing **SUBTITLE** until desired subtitle language is reached.

### Multi-Audio Language Function

(Only available on multi-audio language discs). Press **AUDIO** during playback to display current audio language. Continue pressing **AUDIO** until desired audio language is reached.

### Auxiliary Sources

Push the **DVD/TV/GAME** button to switch to an auxiliary source (i.e. VCR, TV or game console). Push **DVD/TV/GAME** again and the unit will return to the DVD player.

### Repeat Play

While a disc is playing, continue pushing **REPEAT** to select from three repeat modes.

For DVD discs:

Push **REPEAT** to repeat Chapter.

Push **REPEAT** again to repeat Title.

Push **REPEAT** again to repeat All.

Push **REPEAT** once more to Exit.

For CD discs:

Push **REPEAT** to repeat Track.

Push **REPEAT** again to repeat All.

Push **REPEAT** once more to Exit.

### Zoom

While playing a disc, press the **ZOOM** button to increase or decrease the screen image. There are magnification levels: three levels of increased magnification X2, X3, X4 and three levels of decreased magnification 1/2, 1/3, 1/4. Zoom toggles through each of the six magnification levels, then returns to normal size on the seventh press of the button.

### Function

The function only works for discs having scenes recorded at different angles.

Press **ANGLE** during playback. Each time the button is pressed, the number of the angle changes in sequential order.

### Program Play

(Only available on certain types of discs)

When disc play is stopped:

1. Push the **PROGRAM** button to displayed the programming screen.
2. Use the **NUMBER** buttons to enter the desired chapter or track.

**Example:** To play Track 5, then Track 3, and finally Track 16. Push 3, 5, 10+ 6 in that order.

3. Use the **◀ ▶ ▲ ▼ SELECTION** buttons to select "Start" and then press **ENTER** to start Program Play.

**Note:** When the  symbol is displayed, this signifies an invalid operation that is not accepted by the DVD player.

### Display Disc Playing Time

Continuously pressing the **DISPLAY** button during playback will sequentially display: Title Elapsed, Title Remain, Chapter Elapsed, Chapter Remain, and Display Off. Note: The information displayed is subject to the type of the disc playing.

### PAL/NTSC SETTING

If you find that the picture/audio is distorted, or there is no color (black and white) check that the correct format (PAL or NTSC) is selected for the disc playing was recorded in:

1. There must be no disc in the player.
2. Press the **SETUP** button and use the ◀ ▶ **SELECTION** buttons to go to the "Preferences Page".
3. Use the ▲ ▼ **SELECTION** buttons to go to "TV Type" and push ▶ to enter the submenu.
4. Select either PAL or NTSC.
5. Press the **SETUP** button to confirm.

### MP3 Operation

This DVD player supports MP3 discs. When a MP3 disc is loaded, an image similar to the one below will be displayed.

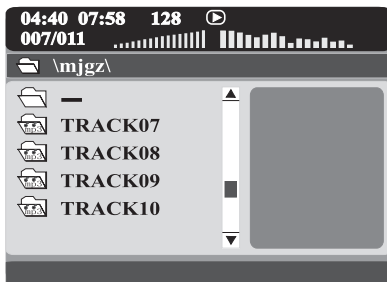

Use the ▲ ▼ **SELECTION** buttons to move the cursor through the MP3 directory. Then push **ENTER** to play desired track. To play another MP3 track, push the **STOP** button, then use the **SELECTION** buttons to select the track. Then push **ENTER** to play desired track.

**Note:** While a disc is playing, you can push the ◀◀ ▶▶ **PREVIOUS** or **NEXT** buttons to select the previous track played or the next track. Then push **ENTER** to play that track.

## System Setup

Press the **SETUP** button to display the System Setup Menu.

Use the ◀ ▶ **SELECTION** buttons to navigate through the menu: General Setup Page, Audio Setup Page, Video Setup Page, and Password Setup Page. Confirm your selection by pressing the **ENTER** button.

In the submenus, use the ▲ ▼ **SELECTION** buttons to make your selection. Confirm your selection by pressing the **ENTER** button. To navigate up and down use the ▲ ▼ **SELECTION** buttons. Confirm your selection by pressing the **ENTER** button.

Press ◀ to escape the submenu and make another selection, or press the **SETUP** button to exit the setup menu. Below is an example of the General Setup Page:

### Set Screen Ratio

Press the **SETUP** button to enter the General Setup Page. Use the ▲ ▼ **SELECTION** buttons to navigate to "TV DISPLAY". Press the **ENTER** button to select.

Press the ▶ button to enter submenu on the right. To change the screen settings, use the ▲ ▼ **SELECTION** buttons to navigate to desired setting. Confirm your selection by pressing the **ENTER** button. Press the **SETUP** button to exit the system setup menu.

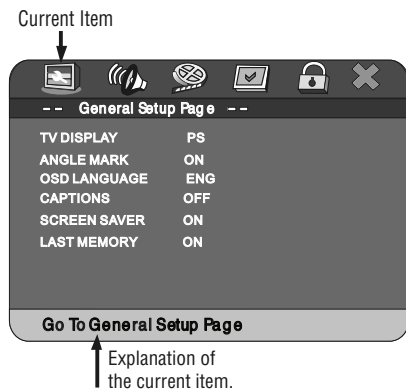
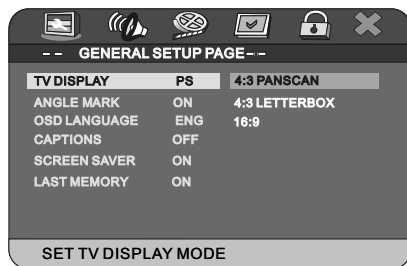

**Note:** There are three screen ratio available: (4:3 Panscan, 4:3 Letterbox, 16:9) They enables user to select a screen ratio to the match the disc. Below is a chart showing the various formats.

Video of Disc	Normal	4:3PS	4:3LB	16:9
4:3				
16:9				

### Set Last Memory Function

The DVD player can identify the last format of the disc being used to store the last frame shown in its memory prior to unit being powered off. This function memorizes the point at which the disc was stopped. The disc can be removed from the unit. Then if the same disc is loaded again, play will resume from the point at which it was stopped, providing that no other disc of the same format was loaded in the interim.

The DVD player memorizes the two different disc formats (DVD and CD). Each type of disc can be stopped, removed from the tray and play can be resumed without affecting the memory function of the other two disc formats. If the DVD player is connected to the vehicle's lighter socket, the last memory function will only operate when the DVD is powered off by the power button on the remote control or from the power button on the unit's front panel.

To activate the Last Memory Function, press the **SETUP** button to access the General Setup Page. Press the **▼ SELECTION** button to access the Last Memory submenu. Press the **► SELECTION** button to highlight "On". Confirm your selection by pressing the **ENTER** button. To exit this menu, press the **SETUP** button.

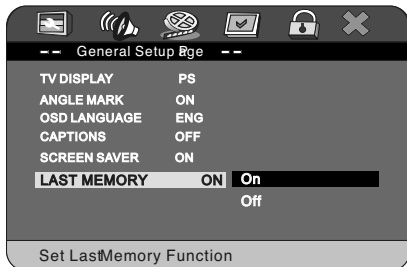



## System Setup

### Video Quality Settings

Press the **SETUP** button to enter the General Setup Page. Navigate to the Video Setup Page using the ◀ ▶ **SELECTION** buttons and press the **ENTER** button to select Color Setting.

Press ▶ then use the **SELECTION** buttons to select between: Sharpness, Brightness, Contrast, Gamma, Hue, Saturation, and Luma Delay. Press ▶ to select the submenu. Then use the **SELECTION** buttons to adjust setting. Press **ENTER** to confirm setting. Press **SETUP** to exit the menu.

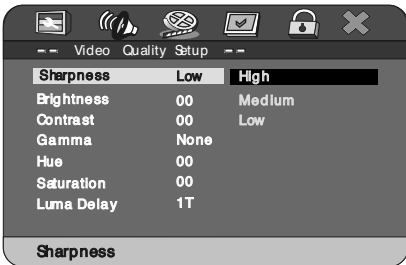

### Parental Control

**Note:** To set Parental Control, there must not be a disc in the player. Press the **SETUP** button to enter the General Setup Page. Navigate to the Preferences Page using the ◀ ▶ **SELECTION** buttons and press the **ENTER** button.

Use the **SELECTION** buttons to select "Parental". A submenu appears requesting password. Enter the factory default password (123456) and press **ENTER**. Select suitable parental level by using the ▲ ▼ **SELECTION** buttons and confirm by pressing the **ENTER** button. Press **SETUP** to exit the menu.

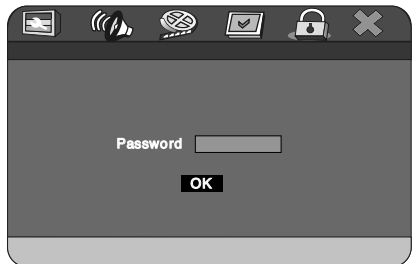
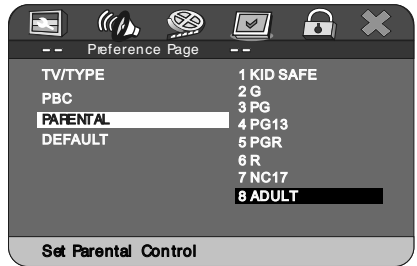

## Troubleshooting

**Only qualified service personnel should remove the cover or service this player. Otherwise the warranty will become invalid.**

If it appears that your DVD unit is faulty, first consult the list below.

### **No Power:**

- Check to see if the player is set to "On".
- Check the power plug of the main unit is properly connected.
- Check that power outlet is properly working.

### **No Picture:**

- Check to see the monitor or TV is switched to "On".
- Select the correct AV input on the monitor or TV.
- Check the video connection.

### **Distorted Picture:**

- Check the disc for fingerprints and clean with soft, dry, cloth, wiping from center to edge.
- A small amount of picture distortion may appear. This may not be a malfunction.

### **Completely Distorted Picture:**

- The disc format is not according to the TV used (PAL/NTSC).

### **No Color in Picture, Distorted or B/W Picture or Distorted Sound from Hi-Fi Amplifier:**

- The disc format is not according to the TV used (PAL/NTSC).

### **No Sound:**

- Check audio connections.
- If using a Hi-Fi amplifier, try another sound source.

### **Disc Does Not Play:**

- Ensure the disc label is facing upwards.
- Clean the disc.
- Check to see if the disc is defective by trying another disc.

### **No Return to Start-Up Screen when Disc is Removed:**

- Press POWER to turn "Off" the unit, then press it again to turn "On" the unit.
- Press RESET button "On" the front panel of the DVD player.

### **The Player Does Not Respond to the Remote Control:**

- Aim the remote control directly at the sensor on the front of the player.
- Avoid all obstacles which may interfere with the signal path.
- Inspect or replace the remote control batteries.

### **No Audio at Digital Output:**

- Check the digital connections.
- Check the Digital Audio menu to make sure that the digital output is correctly set.
- Check if the audio format of the selected audio language matches your receiver's capabilities.

### **Buttons Do Not Work:**

- Press POWER to turn "Off" the unit, then press it again to turn "On" the unit.
- Press RESET button on the front of the DVD unit.

# Replacement Parts Order Form

**Send Orders To:** Magnadyne Corporation  
 ATTN: Consumer Parts Sales  
 P.O. Box 5365  
 Carson, CA 90749-5365

We Accept Checks, Money Orders, Visa and Master Card  
**Make Checks Payable to:** Magnadyne Corporation

**SHIP TO: (No P.O. Boxes)**

\_\_\_\_\_  
**LAST NAME**

\_\_\_\_\_  
**FIRST NAME**

\_\_\_\_\_  
**INITIAL**

\_\_\_\_\_  
**STREET ADDRESS (IF PAYING WITH A CREDIT CARD, YOUR BILLING ADDRESS IS REQUIRED)**

\_\_\_\_\_  
**CITY**

\_\_\_\_\_  
**STATE**

\_\_\_\_\_  
**ZIP CODE**

\_\_\_\_\_  
**DAYTIME PHONE NUMBER**

**CREDIT CARD INFORMATION:**

**CARD TYPE:**  VISA  MASTER CARD

\_\_\_\_\_  
**CARD NUMBER**

\_\_\_\_\_  
**EXP. MONTH**

\_\_\_\_\_  
**YEAR**

\_\_\_\_\_  
**NAME - EXACTLY AS IT APPEARS ON YOUR CREDIT CARD**

Part #	Description	Qty.	Price Each	TOTAL
RC-PL4	Remote Control		\$39.95	

**Shipping and Handling**

Subtotal + Tax	Add
Up to \$20.00	\$5.00
20.01 to 30.00	5.95
30.01 to 45.00	6.50
45.01 to 70.00	6.95
Over 70.01	7.95

Subtotal = \_\_\_\_\_ . \_\_\_\_\_

California Residents Add Sales Tax = \_\_\_\_\_ . \_\_\_\_\_

Shipping and Handling (See Chart) = \_\_\_\_\_ . \_\_\_\_\_

TOTAL = \_\_\_\_\_ . \_\_\_\_\_

**No C.O.D.'s**

On regular orders please allow 4-5 weeks for delivery. Please give a shipping address where this order may be delivered between the hours of 9 a.m. and 5 p.m. weekdays. If UPS is unable to deliver, your order will be returned and additional shipping charges will be required.

## MovieVision Replacement Parts



DESCRIPTION	MODEL #	PRICE
DVD Remote Control	RC-PL4	\$39.95 Each

## Warranty

### ONE (1) YEAR LIMITED WARRANTY

Magnadyne Corporation or its authorized agents will within 1 year from the date of sale to you, repair, replace or refund the retail sales price of said product or any part thereof, at the option of the Magnadyne Corporation or its authorized agents, if said product or part is found defective in materials or workmanship, when properly connected and operating on the correct power requirements designated for the specific product. This warranty and Magnadyne Corporation or its authorized agents obligations hereunder do not apply where the product was; damaged while in the possession of the consumer, subjected to unreasonable or unintended use, not reasonably maintained, utilized in commercial or industrial operations, or serviced by anyone other than Magnadyne Corporation or its authorized agents, or where the warning seal on the product is broken or the power and/or plugs are detached from the unit. Magnadyne Corporation or any of its authorized agents will not assume any labor costs for the removal and re-installation of any product found to be defective, or the cost of transportation to Magnadyne Corporation or its authorized agents. Such cost are the sole responsibility of the purchaser.

This warranty does not cover the cabinet appearance items or accessories used in connection with this product, or any damage to recording or recording tape, or any damage to the products resulting from improper installation, alteration, accident, misuse, abuse or acts of nature.

**MAGNADYNE CORPORATION OR ITS AUTHORIZED AGENTS SHALL NOT BE LIABLE TO ANYONE FOR CONSEQUENTIAL OR INCIDENTAL DAMAGES OR CLAIMS EXCEPT THOSE ACCORDED BY LAW. NO EXPRESSED WARRANTY OR IMPLIED WARRANTY IS GIVEN EXCEPT THOSE SET FORTH HEREIN. NO IMPLIED WARRANTY SHALL EXTEND BEYOND 1 YEAR FROM THE DATE OF SALE.**

This warranty extends only to the original purchaser of the product and is not transferable.

Some states do not allow limitations on how long an implied warranty lasts, and some states do not allow the exclusion or limitation of incidental or consequential damages, so the above limitations or exclusion may not apply to you. This warranty gives you specific legal rights, and you may have other rights that vary from state to state.

Defective merchandise should be returned to the original point of purchase or secondly, to Magnadyne Corporation, 1111 W. Victoria Street, Compton CA 90220. Return Authorization must be obtained before sending, or merchandise may be refused.