

KENWOOD

DVD/VCD/CD PLAYER

DVF-3300

INSTRUCTION MANUAL

Kenwood Corporation



Progressive Scan MP3/WMA



Introduction

Before applying power

 **Caution : Read this page carefully to ensure safe operation.**

Units are designed for operation as follows.

U.S.A., Canada and US-Military **AC 110 – 240 V**
Europe **AC 230 V only**
Australia **AC 240 V only**

Information on Disposal of Old Electrical and Electronic Equipment (applicable for EU countries that have adopted separate waste collection systems)



Products with the symbol (crossed-out wheeled bin) cannot be disposed as household waste.

Old electrical and electronic equipment should be recycled at a facility capable of handling these items and their waste byproducts. Contact your local authority for details in locating a recycle facility nearest to you. Proper recycling and waste disposal will help conserve resources whilst preventing detrimental effects on our health and the environment.

Safety precautions

 **Caution : Read this page carefully to ensure safe operation.**

WARNING : TO PREVENT FIRE OR ELECTRIC SHOCK, DO NOT EXPOSE THIS APPLIANCE TO RAIN OR MOISTURE.

	CAUTION RISK OF ELECTRIC SHOCK DO NOT OPEN		CAUTION: TO REDUCE THE RISK OF ELECTRIC SHOCK, DO NOT REMOVE COVER (OR BACK). NO USER-SERVICEABLE PARTS INSIDE. REFER SERVICING TO QUALIFIED SERVICE PERSONNEL.
	THE LIGHTNING FLASH WITH ARROWHEAD SYMBOL, WITHIN AN EQUILATERAL TRIANGLE, IS INTENDED TO ALERT THE USER TO THE PRESENCE OF UNINSULATED "DANGEROUS VOLTAGE" WITHIN THE PRODUCT'S ENCLOSURE THAT MAY BE OF SUFFICIENT MAGNITUDE TO CONSTITUTE A RISK OF ELECTRIC SHOCK TO PERSONS.		
	THE EXCLAMATION POINT WITHIN AN EQUILATERAL TRIANGLE IS INTENDED TO ALERT THE USER TO THE PRESENCE OF IMPORTANT OPERATING AND MAINTENANCE (SERVICING) INSTRUCTIONS IN THE LITERATURE ACCOMPANYING THE APPLIANCE.		

The marking of products using lasers (For countries other than U.S.A. and U.S.-Military)

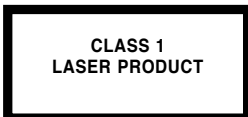

The marking this product has been classified as Class 1. It means that there is no danger of hazardous radiation outside the product.
 Location: Back panel

IMPORTANT SAFETY INSTRUCTIONS

Caution: Read this page carefully to ensure safe operation.

Read Instructions – All the safety and operating instructions should be read before the product is operated.

Retain Instructions – The safety and operating instructions should be retained for future reference.

Heed Warnings – All warnings on the product and in the operating instructions should be adhered to.

Follow Instructions – All operating and use instructions should be followed.

1. Cleaning – Unplug this product from the wall outlet before cleaning. Do not use liquid cleaners or aerosol cleaners. Use a damp cloth for cleaning.

2. Attachments – Do not use attachments not recommended by the product manufacturer as they may cause hazards.

3. Water and Moisture – This product shall not be exposed to dripping and splashing – for example, near a bath tub, wash bowl, kitchen sink, or laundry tub; in a wet basement; or near a swimming pool; and the like. Do not place an object containing liquid, such as a flower vase, on the appliance.

4. Accessories – Do not place this product on an unstable cart, stand, tripod, bracket, or table. The product may fall, causing serious injury to a child or adult, and serious damage to the product. Use only with a cart, stand, tripod, bracket, or table recommended by the manufacturer. Any mounting of the product should follow the manufacturer's instructions, and should use a mounting accessory recommended by the manufacturer.

A product and cart combination should be moved with care. Quick stops, excessive force, and uneven surfaces may cause the product and cart combination to overturn.



5. Ventilation – Slots and openings in the cabinet are provided for ventilation and to ensure reliable operation of the product and to protect it from overheating, and these openings must not be blocked or covered. The openings should never be blocked by placing the product on a bed, sofa, rug, or other similar surface. This product should not be placed in a built-in installation such as a bookcase or rack unless proper ventilation is provided or the manufacturer's instructions have been adhered to.

6. Power Sources – This product should be operated only from the type of power source indicated on the product. If you are not sure of the type of power supply to your home, consult your product dealer or local power company.

7. CAUTION - Polarization – This product may be equipped with a polarized alternating-current line plug (a plug having one blade wider than the other). This plug will fit into the power outlet only one way. This is a safety feature. If you are unable to insert the plug fully into the outlet, try reversing the plug. If the plug should still fail to fit, contact your electrician to replace your obsolete outlet. Do not defeat the safety purpose of the polarized plug.

8. Power Cord Protection – Power-supply cords should be routed so that they are not likely to be walked on or pinched by items placed upon or against them, paying particular attention to cords at plugs, convenience receptacles, and the point where they exit from the product.

9. Lightning – For added protection for this product during a lightning storm, or when it is left unattended and unused for long periods of time, unplug it from the wall outlet and disconnect the antenna or cable system. This will prevent damage to the product due to lightning and power-line surges.

10. Overloading – Do not overload wall outlets, extension cords, or integral convenience receptacles as this can result in a risk of fire or electric shock.

11. Object and Liquid Entry – Never push objects of any kind into this product through openings as they may touch dangerous voltage points or short-out parts that could result in a fire or electric shock. Never spill liquid of any kind on the product.

12. Servicing – Do not attempt to service this product yourself as opening or removing covers may expose you to dangerous voltage or other hazards. Refer all servicing to qualified service personnel.

13. Damage Requiring Service – Unplug this product from the wall outlet and refer servicing to qualified service personnel under the following conditions:

- When the power-supply cord or plug is damaged,
- If liquid has been spilled, or objects have fallen into the product,
- If the product has been exposed to rain or water,
- If the product does not operate normally by following the operating instructions.
- If the product has been dropped or damaged in any way, and
- When the product exhibits a distinct change in performance – this indicates a need for service.
- If an abnormal smell or smoke is detected.

14. Replacement Parts – When replacement parts are required, be sure the service technician has used replacement parts specified by the manufacturer or have the same characteristics as the original part. Unauthorized substitutions may result in fire, electric shock, or other hazards.

15. Safety Check – Upon completion of any service or repairs to this product, ask the service technician to perform safety checks to determine that the product is in proper operating condition.

16. Wall or Ceiling Mounting – This product should be mounted to a wall or ceiling only as recommended by the manufacturer.

17. Heat – This product should be situated away from heat sources such as radiators, heat registers, stoves, or other products that produce heat. Do not place a flaming object, such as a candle or lantern, or near the product.

18. Power Lines – An outside antenna system should not be located in the vicinity of overhead power lines or other electric light or power circuits, or where it can fall into such power lines or circuits. When installing an outside antenna system, extreme care should be taken to keep from touching such power lines or circuits as contact with them might be fatal.

19. Outdoor Antenna Grounding – If an outside antenna or cable system is connected to the product, be sure the antenna or cable system is grounded so as to provide some protection against voltage surges and built-up static charges. Article 810 of the National Electrical Code, ANSI/NFPA 70, provides information with regard to proper grounding of the mast and supporting structure, grounding of the lead-in wire to an antenna discharge unit, size of grounding conductors, location of antenna-discharge unit, connection to grounding electrodes, and requirements for the grounding electrode.

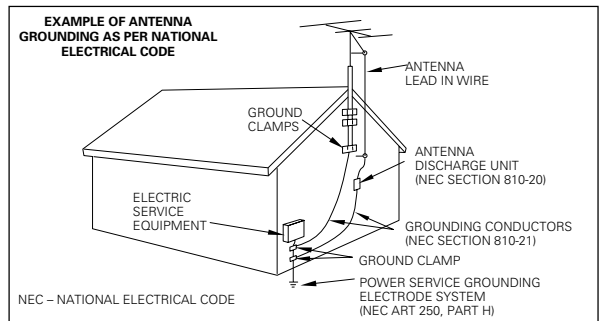

Notes:

- Item 7 is not required except for grounded or polarized equipment.
- Item 19 complies with UL in the U.S.A.

Unpacking

Unpack the unit carefully and make sure that all the accessories are present. If any accessories are missing, or if the unit is damaged or fails to operate, notify your dealer immediately. If the unit was shipped to you directly, notify your shipper immediately. Kenwood recommends that you retain the original carton and packing materials in case you need to move or ship the unit in the future.

Keep this manual handy for future reference.

Accessories

Please confirm that the following accessories are present.

Audio cord (Red, White) ... (1)

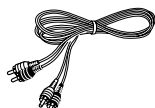

Remote control unit ... (1)



Video cord (Yellow) ... (1)



Coaxial cable (Black) ... (1)

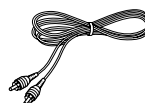

Batteries (R03/"AAA"-size) ... (2)



Screen saver

The screen saver appears when you leave the DVD player in stop mode for about 5 minutes. If the Screen saver is displayed for 5 minutes, the DVD player automatically turns itself off.

For the U.S.A.

CAUTION:

Use of controls or adjustments or performance of procedures other than those specified herein may result in hazardous radiation exposure.

In compliance with Federal Regulations, the following are reproductions of labels on, or inside the product relating to laser product safety.

KENWOOD CORPORATION
2967-3, ISHIKAWA-CHO,
HACHIOJI-SHI,
TOKYO, JAPAN

KENWOOD CORP. CERTIFIES THIS EQUIPMENT
CONFORMS TO DHHS REGULATIONS NO. 21 CFR
1040.10, CHAPTER 1, SUBCHAPTER J.

Location: Back Panel

For the U.S.A.

FCC WARNING

This equipment may generate or use radio frequency energy. Changes or modifications to this equipment may cause harmful interference unless the modifications are expressly approved in the instruction manual. The user could lose the authority to operate this equipment if an unauthorized change or modification is made.

NOTE:

This equipment has been tested and found to comply with the limits for a Class B digital device, pursuant to Part 15 of the FCC Rules. These limits are designed to provide reasonable protection against harmful interference in a residential installation. This equipment may cause harmful interference to radio communications, if it is not installed and used in accordance with the instructions. However, there is no guarantee that interference will not occur in a particular installation. If this equipment does cause harmful interference to radio or television reception, which can be determined by turning the equipment off and on, the user is encouraged to try to correct the interference by one or more of the following measures:

- Reorient or relocate the receiving antenna.
- Increase the separation between the equipment and receiver.
- Connect the equipment into an outlet on a circuit different from that to which the receiver is connected.
- Consult the dealer or an experienced radio / TV technician for help.

For Canada

NOTICE: This Class B digital apparatus complies with Canadian ICES-003.

Special features and Contents

Special features

- ◆ Higher video quality than S-VHS video and LaserDisc
- ◆ Higher audio quality than music CD
- ◆ Graphical User Interface (G.U.I.)
- ◆ MPEG1 , MPEG2 files, DivX® video playback
- ◆ MP3, WMA and JPEG files playback

This document classifies the applications of each feature using the following marks.

 : Description of a feature that can be used with audio CD (CD-DA).

 : Description of a feature that can be used with DVD video.

 : Description of a feature that can be used with VCD.

 : Description of a feature that can be used with DivX® video.



 : Description of a feature that can be used with JPEG.

 : Description of a feature that can be used with MP3.

 : Description of a feature that can be used with WMA.

Contents

Caution : Read the pages marked  carefully to ensure safe operation.

Introduction	2
 Before applying power	2
 Safety precautions	2
 IMPORTANT SAFETY INSTRUCTIONS	3
Special features and Contents	5
Special features	5
Contents	5
Discs information	6
Types of playable discs	6
Unplayable discs	6
Region Codes	7
Region codes in the world	7
Icons on the DVD VIDEO discs	7
Playable files with this unit	8
File Specifications	8
Guidance of Files	8
Video formats	10
Important items	11
Maintenance	11
Reference	11

Preparations

System Connections	12
Controls and indicators	14
Operation of remote control unit	15
Set Up functions	16
Preparation for Set Up	16
Set up menu	16
Language	17
DISPLAY	17
AUDIO	18
LOCK (Parental Control)	18
OTHERS	19
Hierarchical structure of VCD menus (P.B.C. function)	20
DVD menu language code list	21
Area Code list	21

Operations

Basic playback of disc	22
On screen display	22
Last Scene Memory	22
Basic play	23
Disc playback features	24
Repeat play	25
A-B Repeat play	25
Program play	26
Movie disc playback features	27
Select Audio Language	28
Select the Audio channel	28
Using Marker	28
Select Camera angle	29
Select Subtitle Language	29
Zoom function	30
3D Surround	30
Time Search	30
Music disc playback features	31
Using the TV screen to start playback	31
Playback from desired track	31
3D Surround	31
To display the ID3 tag	31
Random play	31
Photo files playback features (JPEG files only)	32
To start playback	32
Zoom function	32
To rotate picture	32
To hide the menu bar	32
Slide show	32









Knowledge

In case of difficulty	33
Specifications	36

Discs information

Types of playable discs

The system this unit is using does not only play music from CD but can also play the discs listed below to offer you high-quality entertainment of video of movies and live concerts.

Playable Disc	DVD VIDEO (DVD-R/RW, DVD+R/RW)		CD (CD-R, CD-RW)		VCD (SVCD*)	
Logo mark on disc						
Disc size	 8cm	 12cm	 8cm	 12cm	 8cm	 12cm
Played sides	One or both	One or both	One side only	One side only	One side only	One side only
Contents	Video + Audio	Approx. 41 min. (1 side, 1 layer) Approx. 75 min. (1 side, 2 layers) Approx. 82 min. (2 sides, 1 layer) Approx. 150 min. (2 sides, 2 layers)	Approx. 133 min. (1 side, 1 layer) Approx. 242 min. (1 side, 2 layers) Approx. 266 min. (2 sides, 1 layer) Approx. 484 min. (2 sides, 2 layers)		Max. 20 min.	Max. 74 min.
	Audio			Max. 20 min., digital	Max. 80 min., digital	(In case of an SVCD, the possible playback time becomes shorter.)

Please refer to page 8 for the CD-R, CD-RW, DVD-R, and DVD-RW file formats which can be played back by this unit.

- * This unit can play SVCDs, but some functions will not work.
- A Dual Disc is a two-sided disc combining a DVD side according to the DVD standard and a music side. The video content recorded on the DVD side can be played back. As the music side is not compatible with the Compact Disc (CD) standard, it cannot be played back on this unit.
- This unit can play back DVD-R and DVD-RW discs recorded in the DVD VIDEO format and DVD+R and DVD+RW discs, but depending on the recording unit, the disc manufacturer, etc., playback sometimes may not be possible.
- This unit may also be incapable of playing certain CD-R/RW discs depending on their properties, recording conditions, etc.
- This player cannot play back discs compatible with CPRM. CPRM is the abbreviation of Content Protection for Recordable Media, and it is a technique for copyright protection for recording media.

Unplayable discs

This player cannot play back any of the following discs.

DVD AUDIO discs
DVD-RAM discs
SACD discs
VSD discs

CDV discs (Only the audio part can be reproduced.)
CD-G/CD-EG/CD-EXTRA discs (Only the audio can be reproduced.)

- A DVD video disc with a region code which does not match this unit or without a region code. For details, see "Region Codes". → [7](#)
- When the video format of a disc differs from that of the TV in use, the disc cannot be played normally. For details, see "Video Formats". → [10](#)

Restrictions due to difference between discs

Some DVD and VCD discs can be played only in certain playback modes according to the intentions of the software producers. Depending on the condition of this unit, operation may be restricted. As this player plays discs according to their intentions, some functions may not work as intended by you. Please be sure to read the instructions provided with each disc. When an inhibition icon is displayed on the TV screen connected to the player, it indicates that the disc being played is under the restriction as described above.

Inhibition icon



Region Codes

Every player of this model has a certain region code assigned to it based on the country where the player is used. When the player is used to play back DVD VIDEO discs, it can only play the DVD VIDEO discs carrying the region codes matching the region code of the player.

The region code for this player is described on the rear panel of the player.

Region codes in the world

The DVD players are given a region code according to the country or area it is marketed, as shown in the following map.

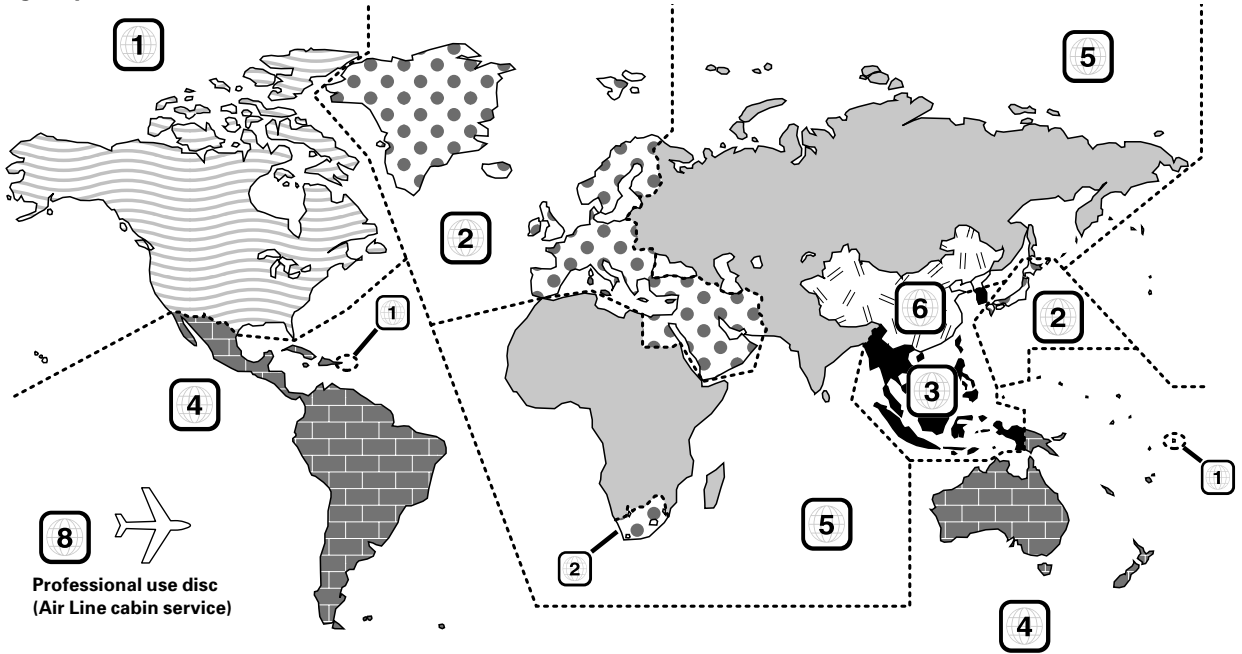

Region codes of the DVD VIDEO discs that can be played with this player

This player can play back a DVD VIDEO disc which carries the corresponding code to the region code of the player shown in the table above, a marking containing the region code of the player or the "ALL" marking shown below. Even when a DVD VIDEO disc does not carry any indication of the region code, it may sometimes be unable to be played on this player due to certain restrictions.



Icons on the DVD VIDEO discs

Icon	Description
	Indicates the region code where the disc can be played.
	Number of voice languages recorded with the audio function. The number in the icon indicates the number of voice languages. (Max. 8 languages)
	Number of subtitle languages recorded with the subtitle function. The number in the icon indicates the number of subtitle languages. (Max. 32 languages)
	Number of angles provided by the angle function. The number in the icon indicates the number of angles. (Max. 9 angles)
	Aspect ratios that can be selected. "4:3 Letter box" stands for Letter Box and "4:3 Panscan" for Pan/Scan.

Playable files with this unit

File Specifications

Category/Item	extension	detail		(Audio)	Media
MOVIE [file size : 4GB (Max.)]					CD-ROM CD-R CD-RW DVD-ROM DVD-R DVD+R DVD-RW DVD+RW 
MPEG1	.MPG, .MPEG	video resolution : 720 x 576 (Max.)	Bit Rate :5Mbps (Max.)	Mpeg1 Layer1 & 2	
MPEG2	.MPG, .MPEG	video resolution : 720 x 576 (Max.)	Bit Rate :5Mbps (Max.)	Mpeg1 Layer1 & 2	
DivX® VIDEO*	.AVI, .DIVX	video resolution : 720 x 576 (Max.)	Bit Rate :10Mbps (Max.)	WAV, MP3, WMA Dolby Digital	
XviD	.AVI, XVID	video resolution : 720 x 576 (Max.)	Bit Rate :10Mbps (Max.)	WAV, MP3, WMA Dolby Digital	
MUSIC [file size : 4GB (Max.)]					
MPEG Audio	.MP3	Layer III Bit Rate 8 - 320 kbps, CBR/VBR	FS 32k, 44.1k, 48k		
WMA (ver7)	.WMA	Bit Rate 32 - 320 kbps, CBR	FS 32k, 44.1k, 48k		
WMA (ver8)	.WMA	Bit Rate 32 - 320 kbps, CBR	FS 32k, 44.1k, 48k		
PHOTO [file size : 4MB (Max.)]					
JPEG	.JPG, .JPEG	video resolution : 3072 x 2048 (Max.)	24bit True color		

- Depending on the data recording condition and other factors, playback may not be possible.
- Usable formats for MP3/WMA/JPEG : ISO9660 level 1, 2, 3 (excluding expanded formats : Joliet, Romeo)

*Official DivX® Certified product.

Plays all versions of DivX® video (including DivX® 6) with standard playback of DivX® media files.

Guidance of Files

Creating media for playing back on this equipment

Compressing MP3/WMA

Please set up the transfer bit rate setting for the compression software when compressing MP3/WMA files as follow.

MP3 Files : 128kbps recommended (8 - 320 kbps)

WMA Files : 128kbps recommended (32 - 320 kbps)

- This unit is compatible with 32 kHz, 44.1 kHz(recommended) and 48 kHz sampling frequencies.
- This unit is compatible with ID3-TAG Ver. 1. (Alphanumeric sign : up to 30 characters)
- DIGITAL output of MP3/WMA data is done not as MP3/WMA data, but as PCM data.

Naming folders and files

Single-byte characters between A and Z, single-byte numerals between 0 and 9, and the single-byte underscore(_) can be displayed. Ensure that the extension log is attached to all file names.

- Never add the wrong extension log to any files, the equipment will assume that they can be played back, and this will produce loud noises in the speakers, resulting in damage of adverse effects.



Folder names and file names are displayed up to 20 characters. When folder names and file names are recorded with more than 20 characters, the names will be displayed in abbreviated form.

Confirming media and files

Check to ascertain that MP3/WMA files can be played back correctly on the personal computer in use prior to saving them onto the media. Check to ensure that the saved file can be played back normally.

- It is not possible to confirm that files can be played back correctly while they are being saved onto the media.

When saving files onto media

Ensure that the session is closed or finalized when data has been written on media. There are cases where media on which the session has not been closed or finalized will not be played back correctly with this equipment.

- There are cases where the folder names and file names will not be displayed correctly depending on the software used to save them.
- Do not store files or folders other than playable files on media to be played back with this equipment.
- It is recommended that ten or less sessions are stored when recording MP3/WMA files onto a media.
- In case of a multisession disc, some time may be required until playback begins.
- There are cases where playback is not possible when DivX/MP3/WMA/JPEG files (CD-ROM) and music CD information (CD-DA) are saved on the same media.

Example for a hierarchical structure

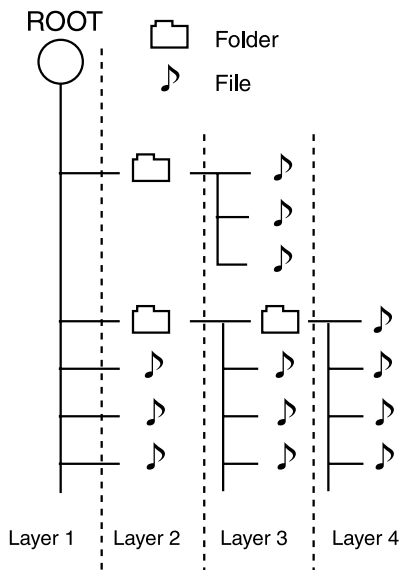

Video formats

The TV picture display and disc signal systems can be divided roughly into two TV formats (NTSC and PAL).

They are variable depending on countries and areas.

TV formats of major countries

TV Format	Major Countries & Areas
NTSC	Japan, Taiwan, Korea, USA, Canada, Mexico, Philippines, Chile, etc.
PAL	China, U.K., Germany, Australia, New Zealand, Kuwait, Singapore, etc.

This unit has a function for changing the video format according to the TV type. Please confirm the type of your TV.

Checking the Video Format

Check the video format of the TV to be used

When the video formats are different :

Try playing the disc. If the video formats of the disc and TV do not match, the played video may be black and white or become as shown below.

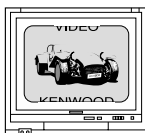

Top and bottom edges are not displayed.



Top and bottom areas are dark.



Picture turbulence due to sync unmatching.

To select TV Type (only for Europe and Australia)

- 1 Remove the disc from the unit, then close the tray.



- 2 Press and hold the PAUSE key on the front panel for more than 5 seconds to be able to select a TV type (PAL, NTSC or AUTO).



Important items

Maintenance

Maintenance of the unit

When the front panel or case becomes dirty, wipe with a soft, dry cloth. Do not use thinner, benzine, alcohol, etc. for these agents may cause discoloration.

In regard to contact cleaner

Do not use contact cleaners because it could cause a malfunction. Be specially careful not to use contact cleaners containing oil, for they may deform the plastic component.

Reference

Disc handling precautions

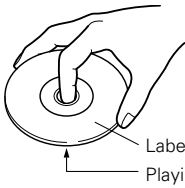

Handling

Hold the disc so that you do not touch the playing surface.

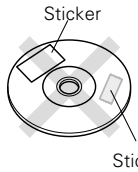

Do not attach paper or tape to either the playing side or the label side of the disc.

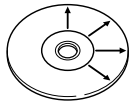

Cleaning

If there are fingerprint marks or foreign matter found on the disc, lightly wipe the disc with a soft cotton cloth (or similar) from the center of the disc outwards in a radial manner.

Storage

When a disc is not to be played for a long period of time, remove it from the player and store it in its case.

Never play a cracked or warped disc

During playback, the disc rotates at high speed in the player. Therefore, to avoid danger, never use a cracked or deformed disc or a disc repaired with tape or adhesive agent. Please do not use discs which are not round because they may cause malfunction.

Disc accessories

The disc accessories (stabilizer, protection sheet, protection ring, etc.) which are marketed for improving the sound quality or protecting discs as well as the disc cleaner should not be used with this system because they may cause malfunction.

Note related to transportation and movement

Before transporting or moving this unit, carry out the following operations.

1. Set the POWER ON/OFF switch to the ON without loading a disc.
2. Wait a few seconds and verify that the display shown appears.

no d 150 (no disc)

3. Set the POWER ON/OFF switch to OFF.

Caution on condensation

Condensation (of dew) may occur inside the unit when there is a great difference in temperature between this unit and the outside. This unit may not function properly if condensation occurs. In this case, leave the unit for a few hours and restart the operation after the condensation has dried up.

Be specially cautious against condensation in the following circumstances:

When this unit is carried from one place to another across a large difference in temperature, when the humidity in the room where this unit is installed increases, etc.

System Connections

Make connections as shown below.

When connecting the related system components, refer also to the instruction manuals of the related components.

CAUTION

Connect the components as shown in the diagram. Only plug the AC power cord into an AC wall outlet once connections are completed.

Malfunction of microcomputer

If operation is not possible or erroneous display appears even though all connections have been made properly, reset the microcomputer referring to "In case of difficulty". → 33

CAUTION

Install the equipment so that the power outlet is easily accessible and, in case of emergency, immediately unplug the power cord from the power outlet. The power in this equipment will not be completely cut off from the AC wall outlet when the main switch is turned OFF.

Connecting to a TV with video (composite) or S-video input terminal

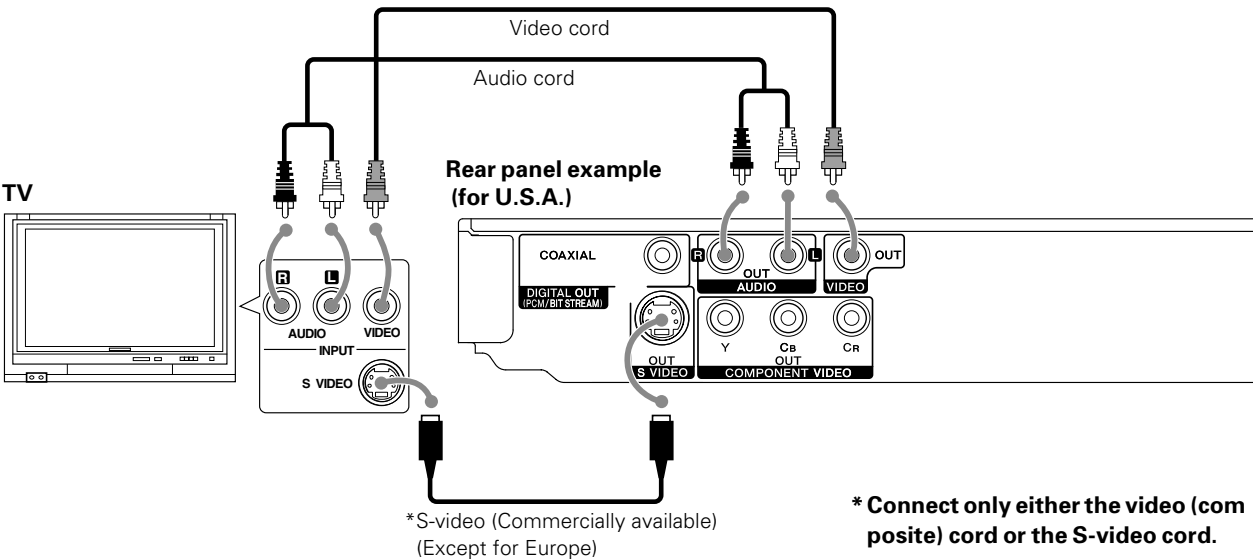

Connecting to a TV with SCART input terminal (For Europe) - 17 "TV Output Select (only for Europe)"

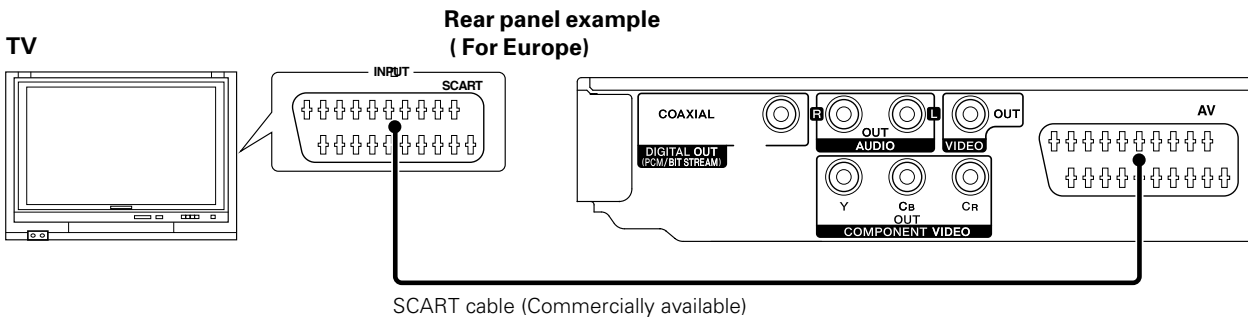

Note Make sure the DVD player is connected directly to the TV and not to a VCR, otherwise the DVD image could be distorted by the copy protection system.

Connecting to a TV with Component input terminals

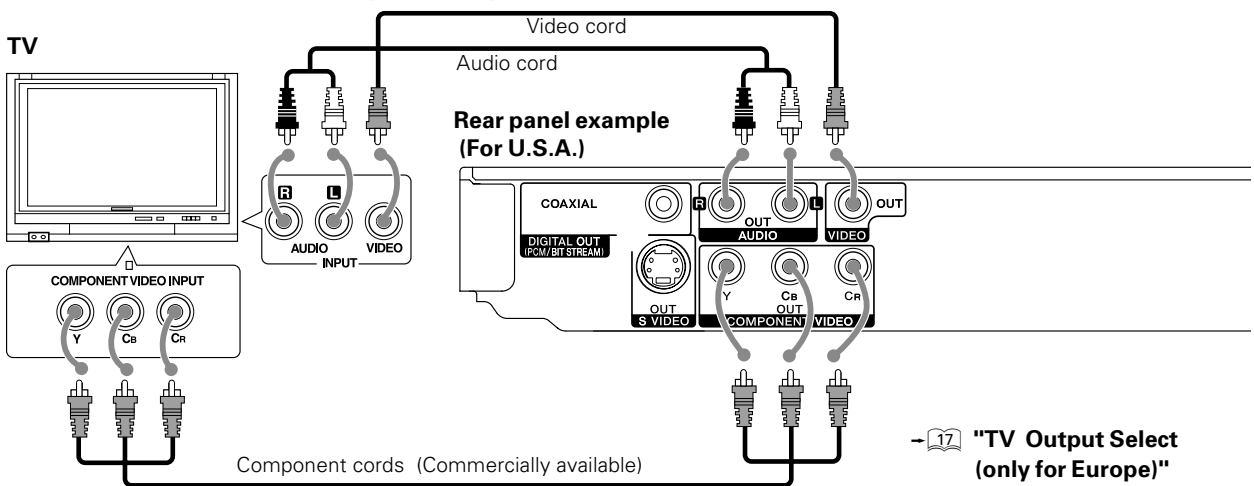

Connecting to an Audio component

For playback of DTS audio, please connect an AV receiver or an AV amplifier which can decode DTS by digital connection.

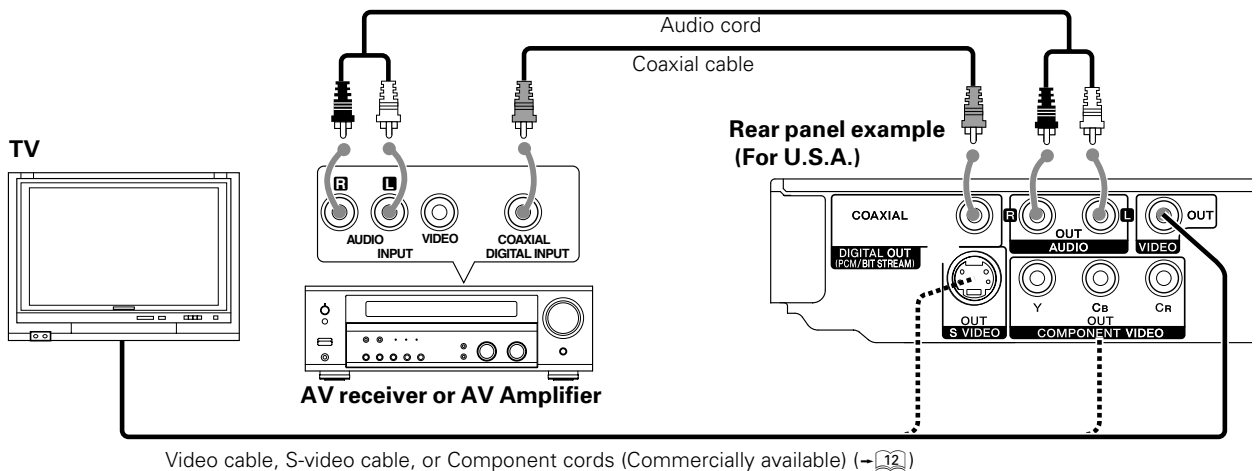

Amplifier equipped with 2-channel analog stereo or Dolby Pro Logic II / Pro Logic:

Connect the left and right **AUDIO OUT** jacks on the DVD player to the audio left and right IN jacks on your amplifier, receiver, or stereo system, using the audio cords.

Amplifier equipped with 2-channel digital stereo (PCM) or a multi-channel decoder (Dolby Digital™, MPEG 2, or DTS):

Connect one of the DVD Player's **DIGITAL OUT** jacks (**COAXIAL**) to the corresponding in jack on your amplifier. Use a digital (coaxial) cable.

DTS disclaimer clause

When playing DTS-encoded (CDs, DVDs), excessive noise will be exhibited from the analog stereo outputs. To avoid possible damage to the audio system, the consumer should take proper precautions when the analog stereo outputs of the DVD player is connected to an amplification system.

To enjoy DTS Digital Surround™ playback, an external 5.1 channel DTS Digital Surround™ decoder system must be connected to the digital output (S/P DIF, AES/EBU, or TosLink) of the DVD player.



1. In case an associated system component is connected, also read the instruction manual of the component.
2. If the audio format of the digital output does not match the capabilities of your receiver (amplifier), the receiver produces a strong, distorted sound or no sound at all.

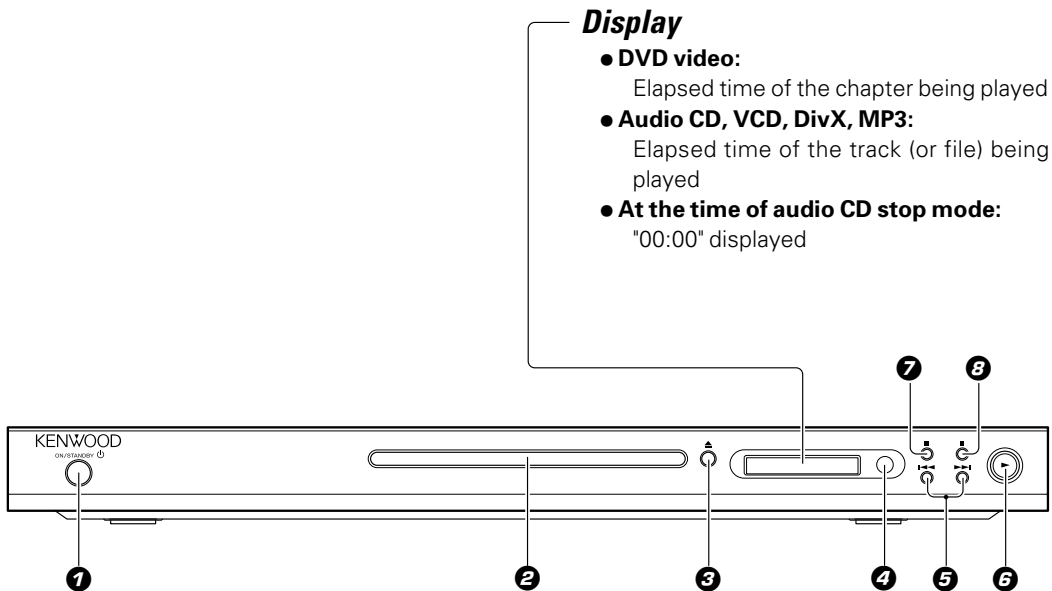

Display

- **DVD video:**
Elapsed time of the chapter being played
- **Audio CD, VCD, DivX, MP3:**
Elapsed time of the track (or file) being played
- **At the time of audio CD stop mode:**
"00:00" displayed

- ① ON/STANDBY key → 15 → 16 → 23
- ② Disc tray → 23
- ③ ▲ (Open/Close) key → 23
- ④ Remote sensor → 15
- ⑤ ◀◀(PREV.), ▶▶(NEXT) (Skip) / Search keys → 24

- ⑥ ▶ (Play) key → 23
- ⑦ ■ (Stop) key → 24
- ⑧ || (Pause) key → 16 → 24

STANDBY MODE

At the time of power off with the power cord inserted into a power outlet, a small amount of power is supplied to the system to back up the memory. This is called standby mode. Under the condition, the system can be turned ON by the remote control unit.

Operation of remote control unit

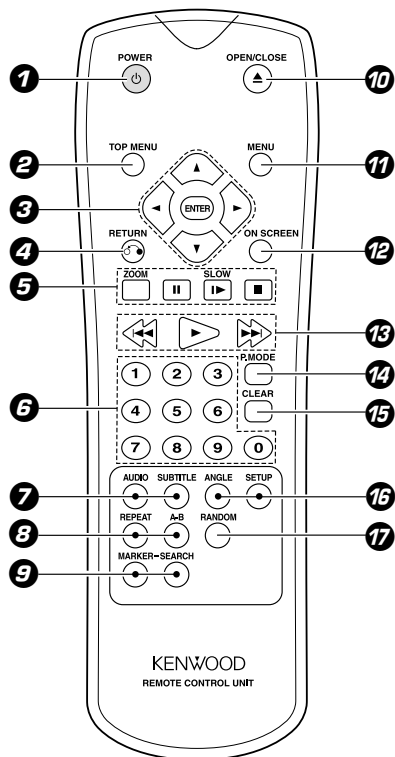

The keys on the remote control unit with the same names as on the main unit have the same function as the keys on the main unit.

- ① POWER key
- ② TOP MENU key - [23]
- ③ Cursor (▲) Up, (▼) Down, (◀) Left and (▶) Right keys - [16] - [23] - [26] - [27] - [30]
- ENTER key - [16] - [23] - [26] - [28] - [30]
- ④ RETURN key - [20]
- ⑤ ZOOM key - [30] - [32]
- ⏸ (Pause) key - [16] - [24]
- ⏪ (Slow) key - [27]
- (Stop) key - [24]
- ⑥ Numeric keys - [27] - [30]
- ⑦ AUDIO key - [28] - [31]
- ⑧ REPEAT key - [25]
- A-B (A-B repeat) key - [25]
- ⑨ MARKER key - [28]
- (MARKER) SEARCH key - [28]
- ⑩ (▲) OPEN/CLOSE key - [23]
- ⑪ MENU key - [23]
- ⑫ ON SCREEN key - [22] - [31]
- ⑬ ◀◀ (PREV.) key/▶▶ (NEXT) key (Skip key) - [24]
- ▶ (Play) key - [23] - [26] - [27] - [31]
- ⑭ P.MODE key - [26]
- ⑮ CLEAR key - [17] - [26] - [28]
- ⑯ ANGLE key - [29]
- SETUP - [16]
- ⑰ RANDOM key - [29] - [31]

Model : RC-D0314 (Infrared ray system)

Loading batteries

① Remove the cover.

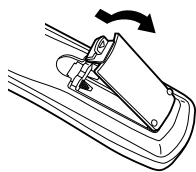

② Insert batteries.

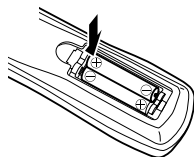

- Insert two R03 ("AAA"-size) batteries following the polarity indications.

③ Close the cover.

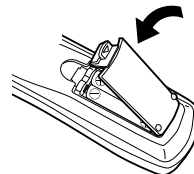

Operation

Insert the power plug into a power outlet, press the ON/STANDBY key of the main unit or the POWER key on the remote control to on, then press the desired key.

- When pressing more than one remote control keys successively, press the keys securely by leaving an interval of 1 second or more between pressing of keys.

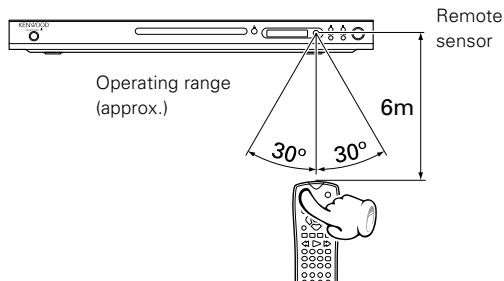

1. The provided batteries are intended for use in operation checking, and their service life may be short.
2. When the remote controllable distance becomes short, replace both of the batteries with new ones.
3. If direct sunlight or the light of a high-frequency fluorescent lamp (inverter type, etc.) is incident to the remote sensor, malfunction may occur. In such a case, change the installation position to avoid malfunction.

Set Up functions

Preparation for Set Up

- 1 Press the ON/STANDBY key to power on.

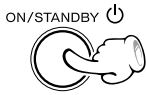

- 2 Set Video Format according to the connected TV type. (To select TV Type -- )

MAIN UNIT



If the video formats of the disc and TV do not match, press and hold PAUSE key on the front panel for more than 5 seconds to be able to select a TV type (PAL, NTSC or AUTO). (No disc inserted)

Set up menu

Initial Settings

By using the Setup menu, you can make various adjustments to items such as picture and sound. You can also set a language for the subtitles and the Setup menu, among other things. For details on each Setup menu item, see pages 17 to 20.

To display and exit the Menu:

Press SETUP key to display the menu. A second press of SETUP key will take you back to initial screen.



To go to the next level:

Press the Cursor right (▶) key on the remote.

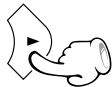

To go back to the previous level:

Press the Cursor left (◀) key on the remote.

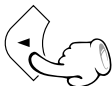

General Operation

- 1 Press SETUP key.
The Setup menu appears.



- 2 Use the Cursor up/down (▲/▼) keys on the remote to select the desired option, then press the Cursor right (▶) key to move to the second level.

The screen shows the current setting for the selected item, as well as alternate setting(s).

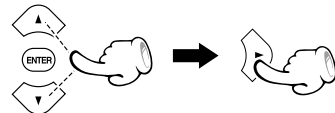

- 3 Use the Cursor up/down (▲/▼) keys on the remote to select the second desired option, then press the Cursor right (▶) key to move to the third level.

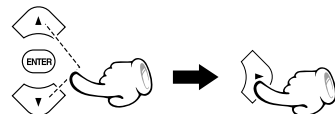

- 4 Use the Cursor up/down (▲/▼) keys on the remote to select the desired setting, then press ENTER key to confirm your selection. Some items require additional steps.

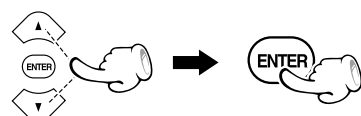

- 5 Press SETUP key or PLAY key to exit the Setup menu.

LANGUAGE



Menu Language

Select a language for the Setup menu and on-screen display.

Disc Audio/ Disc Subtitle/ Disc Menu

Select the language you prefer for the audio Track (disc audio), subtitles, and the disc menu

Original: Refers to the original language in which the disc was recorded.

Other: To select another language, press numeric keys then **ENTER** key to enter the corresponding digit number according to the language code list in the reference chapter. If You enter the wrong Language code, press **CLEAR** key.



DISPLAY

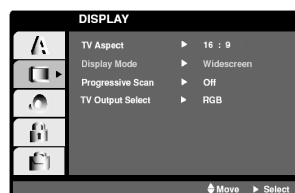

TV Aspect

4:3: Select when a standard 4:3 TV is connected.

16:9: Select when a 16:9 wide TV is connected.

Display Mode

Display Mode setting works only when the TV Aspect mode is set to "4:3".

Letterbox: Displays a wide picture with bands on the upper and lower portions of the screen.

Panscan: Automatically displays the wide Picture on the entire screen and cuts off the portions that do not fit.

Progressive Scan

If you are using the **COMPONENT VIDEO** jacks, but are connecting the DVD Player to a standard (analog) television, set Progressive Scan to **Off**.

If you are using the **COMPONENT VIDEO** jacks for connection to a TV or monitor that is compatible with a progressive scan signal, set Progressive Scan to **On**.



Once the setting for progressive scan output is entered, an image will only be visible on a progressive scan compatible TV or monitor. If you set Progressive Scan to **On** in error, you must reset the unit.

① Press **■ (stop) key to stop any disc that is playing.**

② Press **■ (stop) key again for more than 5 seconds.**

The video output will be restored to the standard setting, and a picture will once again be visible on a conventional analog TV or monitor.

TV Output Select (only for Europe)

Set the player's TV Output Select options according to the TV connection type.

RGB: When your TV is connected with the **SCART** jack.

Y Cb Cr: When your TV is connected with the **COMPONENT VIDEO** jacks on the DVD player.

AUDIO

Each DVD disc has a variety of audio output options. Set the player's AUDIO options according to the type of audio system you use.

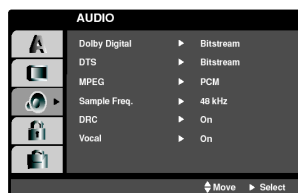

Dolby Digital/ DTS/ MPEG

Bitstream: Select "Bit stream" if you connect the DVD Player's **DIGITAL OUT** jack to an amplifier or other equipment with a Dolby Digital, DTS or MPEG decoder.

PCM (for Dolby Digital/ MPEG): Select when connected to a two-channel digital stereo amplifier. DVDs encoded in Dolby Digital or MPEG will be automatically down mixed to two-channel PCM audio.

Off (for DTS): If you select "Off", the DTS signal is not output through the **DIGITAL OUT** jack.

Sample Freq. (Frequency)

If your receiver or amplifier is NOT capable of handling 96 kHz signals, select 48 kHz. When this choice is made, this unit automatically converts any 96 kHz signals to 48 kHz so your system can decode them.

If your receiver or amplifier is capable of handling 96 kHz signals, select 96 kHz. When this choice is made, this unit passes each type of signal through without any further processing.

Check the documentation for your amplifier to verify its capabilities.

When the disc prohibits 96 kHz digital output, the signal always is put out after down-conversion.

DRC (Dynamic Range Control)

With the DVD format, you can hear a program's soundtrack in the most accurate and realistic presentation possible, thanks to digital audio technology. However, you may wish to compress the dynamic range of the audio output (the difference between the loudest sounds and the quietest ones). This allows you to listen to a movie at a lower volume without losing clarity of sound. Set DRC to On for this effect.

This function operates only at the time of playback of DVDs recorded with Dolby Digital.

Vocal

Set to on only when a multi-channel karaoke DVD is playing. The karaoke channels on the disc mix into normal stereo sound.

LOCK (Parental Control)



Rating

Some movies contain scenes that may not be suitable for children to view. Many of these discs contain parental control information that applies to the complete disc or to certain scenes on the disc. Movies and scenes are rated from 1 to 8, depending on the country. Some discs offer more suitable scenes as an alternative.

The parental control feature allows you to block access to scenes below the rating you input, thereby preventing your children from being able to view material you believe is unsuitable.

- ① Select "Rating" on the LOCK menu then press the Cursor right (▶) key.
- ② To access the Rating, Password and Area Code features, you must input the 4-digit password you created. If you have not yet entered a password you are prompted to do so.

Input a 4-digit password and press ENTER key. Enter it again and press ENTER key to verify. If you make a mistake before pressing ENTER key, press CLEAR key.
- ③ Select a rating from 1 to 8 using the Cursor up/down (▲/▼) keys.

Rating 1-8: Rating one (1) has the most restrictions and rating eight (8) is the least restrictive.

Unlock

If you select unlock, parental control is not active and the disc plays in full.



If you set a rating for the player, all disc scenes with the same rating or lower are played. Higher rated scenes are not played unless an alternate scene is available on the disc. The alternative must have the same rating or a lower one. If no suitable alternative is found, playback stops. You must enter the 4-digit password or change the rating level in order to play the disc.

- ④ Press ENTER key to confirm your rating selection, then press SETUP key to exit the menu.

LOCK (Parental Control) (Continued)



Password (Security Code)

You can enter or change password.

- ❶ Select **Password** on the LOCK menu then press the **Cursor right (▶)** key.
- ❷ Follow step ❷ as shown "Rating" part (→ 18). "Change" or "New" is highlighted.
- ❸ Enter the new 4-digit code, then press **ENTER** key. Input it again to verify.
- ❹ Press **SETUP** key to exit the menu.

If you forget Password

If you forget your password you can clear using the following steps:

- ❶ Press **SETUP** key to display the Setup menu.
- ❷ Input the 6-digit number "210499" and the password is cleared.
- ❸ Enter a new code as described above.

Area Code

Enter the code of the country/area whose standards were used to rate the DVD video disc, based on the list in the reference chapter.

Ratings are Area-dependent.

- ❶ Select "Area Code" on the LOCK menu, then press the **Cursor right (▶)**.
- ❷ Follow step ❷ as shown "Rating" part (→ 18).
- ❸ Select the first character using the **Cursor up/down (▲/▼)** keys.
- ❹ Shift the cursor using the **Cursor right (▶)** key, and select the second character using the **Cursor up/down (▲/▼)** keys.
- ❺ Press **ENTER** to confirm your Area code selection.

→ 21

OTHERS



PBC

Set Playback Control (PBC) to On or Off.

On: Video CDs with PBC are played according to the PBC.

Off: PBC is switched off and normal playback is made.

B.L.E. (Black Level Expansion)

To select the black level of playback pictures. Set your preference and monitor's ability.

On: Expanded grey scale. (0 IRE cut off)

Off: Standard grey scale. (7.5 IRE cut off)



The B.L.E. function works NTSC system only.

OTHERS (Continued)

DivX(R) VOD

You can display the DivX DRM (Digital Rights Management) Registration code for your unit only. The Registration code is used for VOD (Video-On-Demand) service agent. You can purchase or rent an encrypt movie file.



If you rent the DivX VOD file, it has several options of viewing limits as shown below.

- Display the number which you can watch the file.
- The rental has been expired.
- Display the authorization error.

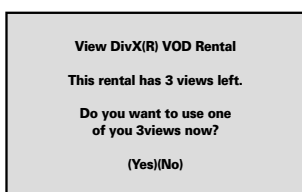

Hierarchical structure of VCD menus (P.B.C. function)

When an item is selected on the menu screen during playback of a P.B.C.-compatible VCD, another menu with more details items may be displayed. When a number of menus are connected in multiple layers in this way, it is said that the menus have a hierarchical structure. In this structure, the desired scene can be reached by repeating item selections on the menu screens.

Example for a hierarchical structure

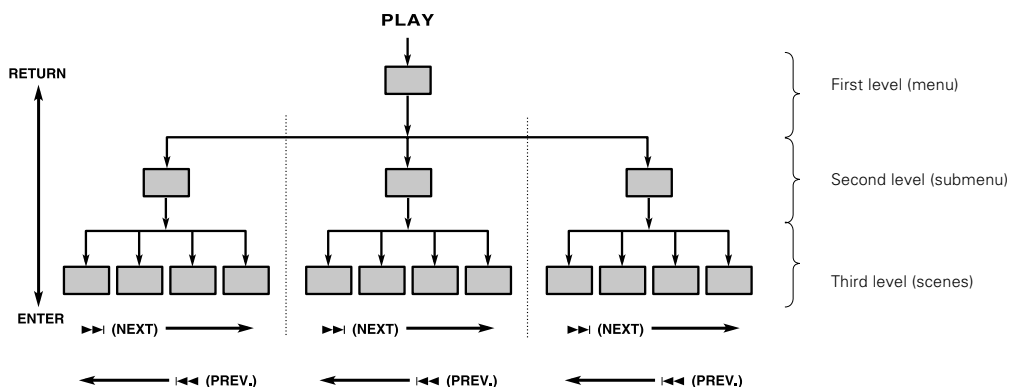

Advancing

When an item is selected on the menu screen with the ENTER (Select) key or the numeric keys, advance is made to the next lower menu level. When the advance destination is the "scene" to be played, the contents will be played.

- When several menus (scenes) can be selected in each level, screen switching is possible with the keys ►► (NEXT) and ◀◀ (PREV.).

Returning

Each time the RETURN key is pressed, return is made to the next higher menu.

DVD menu language code list

Language	Code
Abkhazian	6566
Afar	6565
Afrikaans	6570
Albanian	8381
Ameharic	6577
Arabic	6582
Armenian	7289
Assamese	6583
Aymara	6588
Azerbaijani	6590
Bashkir	6665
Basque	6985
Bengali; Bangla	6678
Bhutani	6890
Bihari	6672
Breton	6682
Bulgarian	6671
Burmese	7789
Byelorussian	6669
Cambodian	7577
Catalan	6765
Chinese	9072
Corsican	6779
Croatian	7282
Czech	6783
Danish	6865
Dutch	7876
English	6978
Esperanto	6979
Estonian	6984
Faroese	7079

Language	Code
Fiji	7074
Finnish	7073
French	7082
Frisian	7089
Galician	7176
Georgian	7565
German	6869
Greek	6976
Greenlandic	7576
Guarani	7178
Gujarati	7185
Hausa	7265
Hebrew	7387
Hindi	7273
Hungarian	7285
Icelandic	7383
Indonesian	7378
Interlingua	7365
Irish	7165
Italian	7384
Japanese	7465
Javanese	7487
Kannada	7578
Kashmiri	7583
Kazakh	7575
Kirghiz	7589
Korean	7579
Kurdish	7585
Laothian	7679
Latin	7665
Latvian, Lettish	7686

Language	Code
Lingala	7678
Lithuanian	7684
Macedonian	7775
Malagasy	7771
Malay	7783
Malayalam	7776
Maltese	7784
Maori	7773
Marathi	7782
Moldavian	7779
Mongolian	7778
Nauru	7865
Nepali	7869
Norwegian	7879
Oriya	7982
Panjabi	8065
Pashto, Pushto	8083
Persian	7065
Polish	8076
Portuguese	8084
Quechua	8185
Rhaeto-Romance	8277
Rumanian	8279
Russian	8285
Samoan	8377
Sanskrit	8365
Scots Gaelic	7168
Serbian	8382
Serbo-Croatian	8372
Shona	8378
Sindhi	8368

Language	Code
Singhalese	8373
Slovak	8375
Slovenian	8376
Somali	8379
Spanish	6983
Sudanese	8385
Swahili	8387
Swedish	8386
Tagalog	8476
Tajik	8471
Tamil	8465
Tatar	8484
Telugu	8469
Thai	8472
Tibetan	6679
Tigrinya	8473
Tonga	8479
Turkish	8482
Turkmen	8475
Twi	8487
Ukrainian	8575
Urdu	8582
Uzbek	8590
Vietnamese	8673
Volapük	8679
Welsh	6789
Wolof	8779
Xhosa	8872
Yiddish	7473
Yoruba	8979
Zulu	9085

Area Code list

Area	Code
Afghanistan	AF
Argentina	AR
Australia	AU
Austria	AT
Belgium	BE
Bhutan	BT
Bolivia	BO
Brazil	BR
Cambodia	KH
Canada	CA
Chile	CL
China	CN
Colombia	CO
Congo	CG
Costa Rica	CR
Croatia	HR
Czech Republic	CZ
Denmark	DK
Ecuador	EC
Egypt	EG
El Salvador	SV

Area	Code
Ethiopia	ET
Fiji	FJ
Finland	FI
France	FR
Germany	DE
Great Britain	GB
Greece	GR
Greenland	GL
Islands	HM
Hong Kong	HK
Hungary	HU
India	IN
Indonesia	ID
Israel	IL
Italy	IT
Jamaica	JM
Japan	JP
Kenya	KE
Kuwait	KW
Libya	LY
Luxembourg	LU

Area	Code
Malaysia	MY
Maldives	MV
Mexico	MX
Monaco	MC
Mongolia	MN
Morocco	MA
Nepal	NP
Netherlands	NL
Netherlands Antilles	AN
New Zealand	NZ
Nigeria	NG
Norway	NO
Oman	OM
Pakistan	PK
Panama	PA
Paraguay	PY
Philippines	PH
Poland	PL
Portugal	PT
Romania	RO
Russian Federation	RU

Area	Code
Saudi Arabia	SA
Senegal	SN
Singapore	SG
Slovak Republic	SK
Slovenia	SI
South Africa	ZA
South Korea	KR
Spain	ES
Sri Lanka	LK
Sweden	SE
Switzerland	CH
Taiwan	TW
Thailand	TH
Turkey	TR
Uganda	UG
Ukraine	UA
United States	US
Uruguay	UY
Uzbekistan	UZ
Vietnam	VN
Zimbabwe	ZW

Basic playback of disc

On screen display

The on-screen Banner Display contains many playback features. To see the Banner Display, press ON SCREEN key on the remote while a disc is playing. Use the Cursor up/down (▲/▼) keys on the remote to move through the different features in the Banner Display. Each feature is illustrated with an icon.

Example:

On-Screen Display during playing DVD video

On-Screen Display during playing DivX

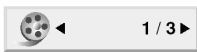

Title Number



Track Number

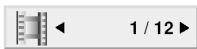

Chapter Number

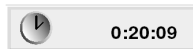

Time search



Time search



Audio language and Digital Audio Output mode



Audio language and Digital Audio Output mode

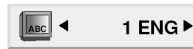

Subtitle language



Subtitle language

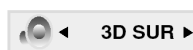

Sound

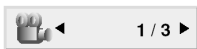

Angle



Sound

On-Screen Display during playing VCD

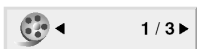

Track Number (or PBC mode)



Time search



Audio Channel



Sound



The on screen display is switched off when no operation is performed for a few seconds.

Last Scene Memory

This player memorizes last scene from the last disc that is viewed. The last scene remains in memory even if you remove the disc from the player or switch off the player. If you load a disc that has the scene memorized, the scene is automatically recalled.

If you don't want to use the Last Scene Memory, press the STOP key during stop.



This player does not memorize the scene of a disc if you switch off the player before commencing to play the disc.

Basic play

1 Load a disc.

1 Press the ON/STANDBY key to power on.

MAIN UNIT ON/STANDBY

REMOTE POWER

2 Open the tray.

MAIN UNIT

REMOTE OPEN/CLOSE

3 Place a disc.

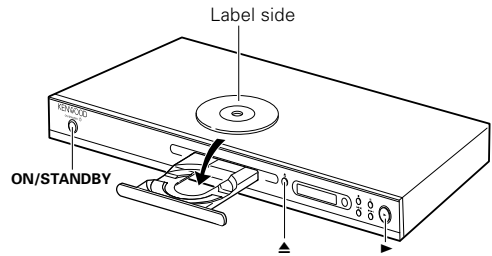

2 Start playback.

To start playback of DVD video, audio CD or VCD.

MAIN UNIT

REMOTE

- When the ► key is pressed while a tray is open, the tray closes automatically, and then playback begins.

Elapsed time of the chapter, track or file display.



When a menu screen is recorded on the DVD disc, the menu screen will be displayed when the TOP MENU key or MENU key is pressed. At the menu screen, the menu can be selected by pressing the Cursor keys.

Note **When a Disc Menu appears on the screen**

In case of interactive DVDs, a Disc Menu appears on the screen. Then press **ENTER** to select specific menu you want to play by using Cursor keys.

To start playback of audio CD, DivX, MP3, WMA or JPEG files.

- It is not possible to play back folders and files that exceed the maximum limitations of the media.
- A certain amount of time is required for the player to confirm the media on which DivX/MP3/WMA/JPEG files have been recorded before playback will commence.

Press Cursor up/down (▲/▼) keys on the remote to select desired track or file, then press the PLAY key or the ENTER key to start playback.

Press and hold Cursor up/down (▲/▼) keys to go to the next / previous page or press MENU key on the remote to go to the next page.

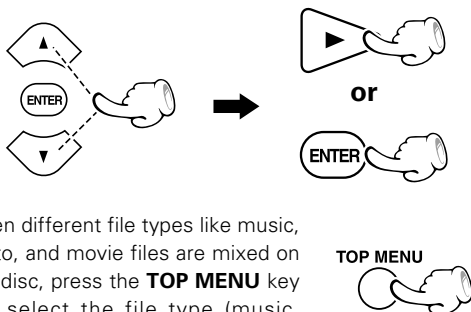

- When different file types like music, photo, and movie files are mixed on one disc, press the **TOP MENU** key and select the file type (music, photo, movie) to be played back.

DISC menu appears

Example of MP3 menu

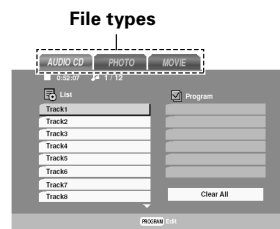

Example of JPEG menu

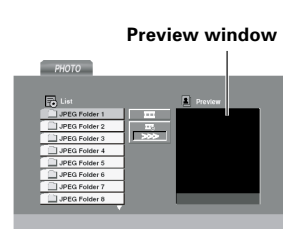

- When JPEG files are displayed, the display is switched automatically from one file to the next. (Slide Show)

- Note** After all files of a folder have been played, playback will stop.
- If you are in a file list on the MP3/WMA menu and want to return to the folder list, use Cursor up/down (▲/▼) keys on the remote to highlight and press **ENTER** key.



- You won't hear the sound (audio) on the DVD, VCD and DivX when you're using the Skip, Search, Step or Slow motion features.
- Playback features are not available during the opening credits of a movie.

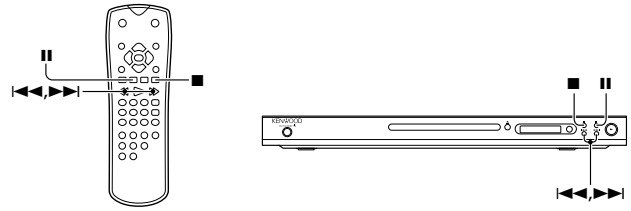

Disc playback features

To stop playback CD DVD VCD DivX JPEG MP3 WMA

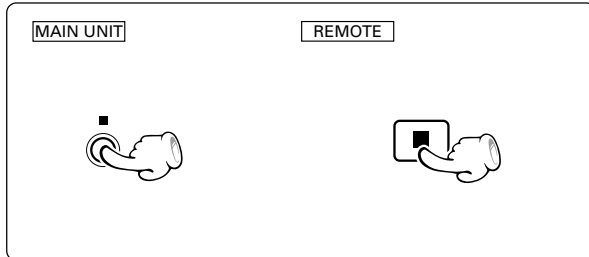

To pause playback CD DVD VCD DivX JPEG MP3 WMA

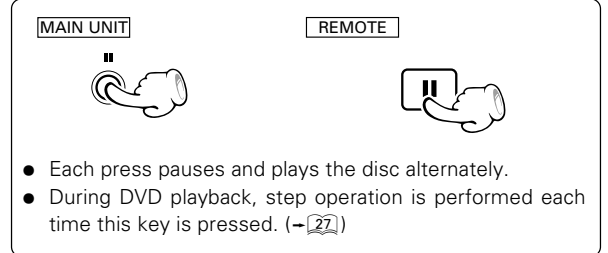

Skipping chapters, tracks or files

CD DVD VCD DivX JPEG MP3 WMA

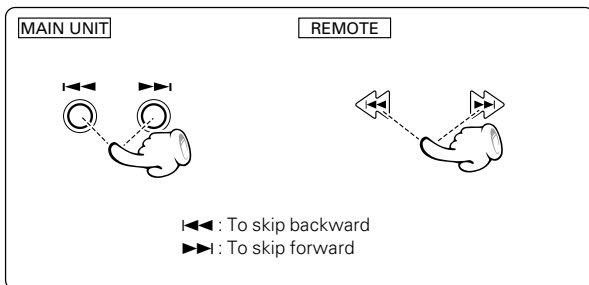

- The chapter (or track) in the direction of the key pressed is skipped, and the selected chapter (or track) will be played from the beginning.
- When the ◀◀ key is pressed once during playback, the chapter (or track) being played will be played from the beginning.
- When the ◀◀ key is pressed within 3 seconds after the start of chapter (or track) playback, playback starts from the start of the preceding chapter (or track).



The Chapter feature won't work if the disc isn't formatted with separate chapters.

Searching CD DVD VCD DivX MP3

- 1 During playback, press ◀◀ or ▶▶ key for more than 2 seconds.

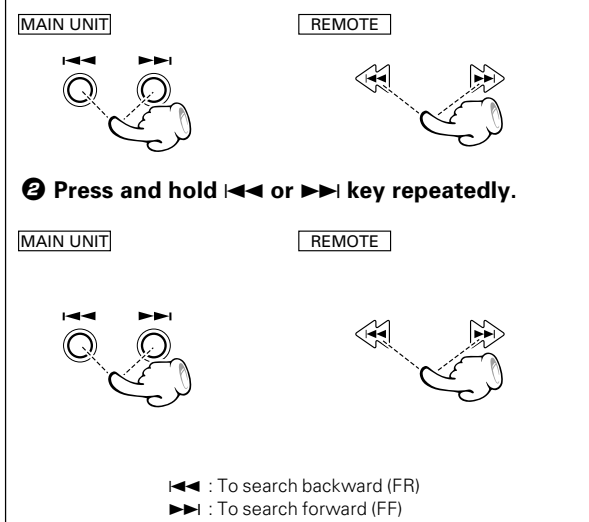

- Each press and hold switches the searching speed.

(At the time of DVD video/DivX playback)

- 1 "▷" (▶▶ key) or "◁" (◀◀ key)
- 2 "▷▷" (▶▶▶ key) or "◁◁" (◀◀◀ key)
- 3 "▷▷▷" (▶▶▶▶ key) or "◁◁◁" (◀◀◀◀ key)
- 4 "▷▷▷▷" (▶▶▶▶▶ key) or "◁◁◁◁◁" (◀◀◀◀◀ key)

(At the time of audio CD/VCD/MP3/WMA playback)

- 1 "▷" (▶▶ key) or "◁" (◀◀ key)
- 2 "▷▷" (▶▶▶ key) or "◁◁" (◀◀◀ key)
- 3 "▷▷▷" (▶▶▶▶ key) or "◁◁◁" (◀◀◀◀ key)

- Press the ▶ key at any time to resume normal playback.

Repeat play

Desired title, chapter, track or disc can be played back repeatedly.

At the time of DVD video playback.

- "Chapter" : Repeat the chapter that is playing.
- "Title" : Repeat the title that is playing.

At the time of audio CD/VCD playback.

- "Track" : Repeat the track that is playing.
- "All" : Repeat the disc that is playing.

At the time of DivX/MP3/WMA playback.

- "Track" : Repeat the file that is playing.
- "All" : Repeat the folder that is playing.

During playback, press the REPEAT key on the remote.



Repeat icon



Each press the key switches the REPEAT mode
At the time of DVD video playback.

- ① "Chapter"
- ② "Title"
- ③ "Off" (Repeat off)

At the times of audio CD/VCD/DivX/MP3/WMA playback.

- ① "TRACK"
- ② "ALL"
- ③ Goes off (Repeat off)

- To cancel repeat playback, press the **REPEAT** key and select "Off".



If you press **SKIP** (▶▶) once during Repeat Chapter or Repeat Track playback, the repeat playback cancels.



P.B.C. on mode of VCD, the Repeat play function does not work. → 

A-B Repeat play

The A-B repeat function lets you mark a segment to repeat between the beginning "A" and the end "B" of the segment you want to replay.

- ① Press the A-B key on the remote when you want to choose a scene (sound) as the beginning point.

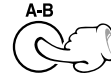

Repeat A icon



- "A" display appears.

- ② Press the A-B key again to choose a scene (sound) as the end point.

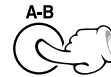

Repeat A-B icon

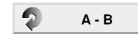

- "A - B" display appears and the repeat sequence begins.
- To cancel A-B Repeat playback, press the **A-B** key.

Program play

You can listen to the desired tracks of the current CD, MP3 or WMA in any desired order.

Program Edit

- ❶ Insert a disc and close the tray. (— 23)

Audio CD or MUSIC menu appears.

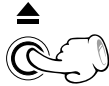

- ❷ Press P.MODE key

The **E** mark will appear to the right of the word "Program" on the right side of the menu screen.

Example of audio CD menu

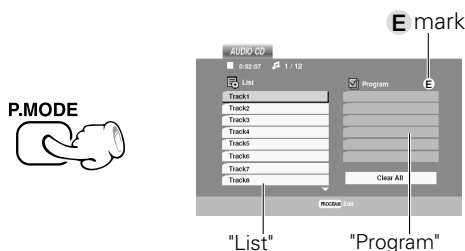

To exit the Program Edit mode, Press **P.MODE** key again.

- ❸ Select a specific track on the "List" by Press Cursor up/down (▲/▼) keys, then press ENTER key to place the selected track on the "Program" list.

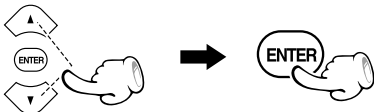

- ❹ You can select maximum 30 values by repeating step ❸.

- ❺ Select the track you want to start playing on the Program list.

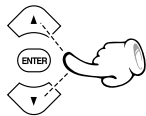

- ❻ Press PLAY key to start.



Playback begins in the order in which you programmed tracks. Playback stops after all of the tracks on the Program list have played once.

- The unit stops when the **STOP** (■) key is pressed. To restart program play, press the **PLAY** key.

To repeat program play

During program playback, press the **REPEAT** key on the remote.



Each press the key switches the mode.

- ① **"TRACK"** : repeats the current track or file.
- ② **"ALL"** : repeats all the tracks (files) on programmed list.
- ③ Goes off (repeat off)



If you press **SKIP** (▶▶) once during Repeat Track playback, the repeat playback cancels.

Delete a track from Program list

- ❶ During **STOP** mode, press **P.MODE** and the **E** mark will appear.



- ❷ Press the Cursor (◀/▶/▲/▼) keys to select the track that you wish to delete from the Program list.

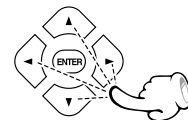

- ❸ Press **CLEAR** key.



Delete the complete Program list

- ❶ During **STOP** mode, press **P.MODE** and the **E** mark will appear.



- ❷ Select **"Clear All"**, then press **ENTER** key.

The complete program for the disc is deleted.

- The programs are also cleared when the disc is removed.

Movie disc playback features

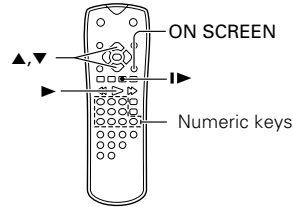

STEP (freeze frame and frame advance) DVD VCD DivX

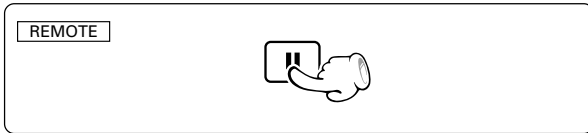

- During playback, press the **PAUSE** key.
- Each time you press the key, the picture advances one frame.
- Press the **▶** key to resume normal playback.

Slow motion playback DVD VCD DivX

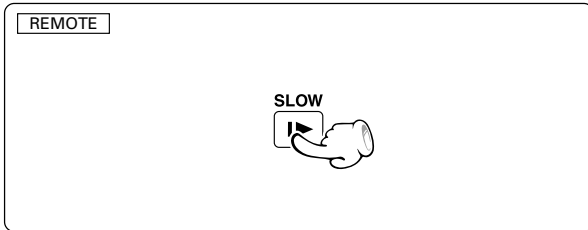

- During playback, press the **SLOW** keys.
- Each press switches the motion speed. (Slow Reverse is not possible)
 - ① 1/7 (▶ key)
 - ② 1/6 (▶ key)
 - ③ 1/4 (▶ key)
 - ④ 1/2 (▶ key)
- Press the **▶** key to resume normal playback.

Playback from desired title, chapter or track DVD VCD DivX

Because DVD video discs use digital technology, a title can be divided into individual chapters (similar to tracks on a CD).

(At the time of DVD video playback)

REMOTE

- Press **ON SCREEN** key.
- Press the **Cursor up/down (▲/▼)** keys on the remote to select the title or chapter icon.

1/3 ▶ **Title/Track icon**

1/12 ▶ **Chapter icon**
- Press the **numeric keys**, then press the **▶ (play)** key.

(Example) To select track No. 23 : **2 3**

Note The Chapter feature won't work if the disc isn't formatted with separate chapters.

(At the time of VCD playback)

REMOTE

Press the **numeric keys**, then press the **▶ (play)** key.

(Example) To select track No. 23 : **2 3**

Note P.B.C. on mode of VCD, the Selecting a Track function may not work. → 20

Select Audio Language

If the disc was created with different language tracks, you can use the AUDIO key on the remote to temporarily change the DVD player's Audio setting.

With DVD-RW discs recorded in VR mode that have both a main and a Bilingual audio channel, you can switch between Main (L), Bilingual (R), or a mix of both (Main + Bilingual) by pressing AUDIO.

During playback, press the AUDIO key on the remote.

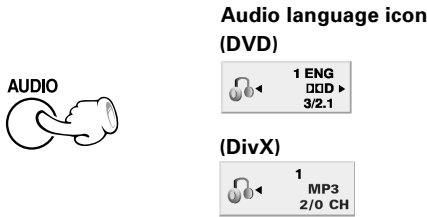

The language is switched each time the AUDIO key is pressed.



1. The language feature only works if the disc was created with multiple audio tracks.
2. When you chose an audio language by the AUDIO key, you only override the audio language setting in the DVD Player's main menu (in the Language Preferences menu within Setup menu) temporarily.

Select the Audio channel

You can choose to play back only the right or the left channel of audio recorded on the disc, or you can select stereo playback.

During VCD playback, press the AUDIO key on the remote.



Each press the key switches the mode.

- 1 LEFT
- 2 RIGHT
- 3 STEREO

Using Marker

The marker feature lets you mark a point on the disc that you can go to quickly. You can store up to 9 marker points

Create the Marker

- 1 When you reach the scene you want to mark, press MARKER key.



- The marker icon appears on the TV screen briefly.
- Repeat to enter up to 9 marker points.

To recall or clear a marked scene

- 1 During playback, press the SEARCH key on the remote.



- The marker search menu appears on the screen.

- 2 Press the Cursor right/left (</>) keys on the remote to select a marker number that you want to recall or clear.

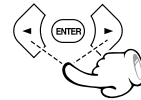

- 3 Press the ENTER key to playback from the marked scene or press the CLEAR key to clear the selected number.

To recall



To clear



- If all 9 marker points are in use, you can still mark new scenes, but the previous marker points will be erased.
 - Depending on the disc, the marker function may not work.
 - P.B.C. on mode of VCD, the marker function does not work.
- 20

Clearing all marker points

- The marker points are cleared each time a disc is removed from the player or when the power is turned off.

Select Camera angle

Some disc contains multiple angles particular scene or sequence. If the disc only has one angle, this feature won't work.

When you are playing a DVD disc contains scenes recorded different camera angles, the angle indicator will blink on the TV screen.

- ❶ During the angle indicator has blinked, press the ANGLE key on the remote.

Angle icon

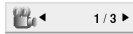

ANGLE

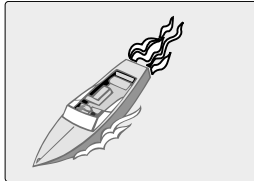

- ❷ Select the Camera angle with press the ANGLE key.

ANGLE

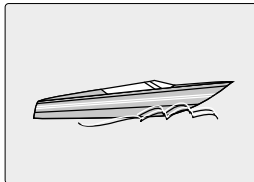

Select Subtitle Language

You can change the Subtitle language while you're watching a disc (but only if the disc was created with subtitles).

During playback, press the SUBTITLE key on the remote.

SUBTITLE



Subtitle language icon

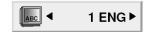

The language is switched each time the SUBTITLE key is pressed.



1. The subtitle feature only works if the disc was created with multiple subtitle tracks.
2. The subtitle menu of the disc appears in some discs.
3. The subtitle file of the DivX file is displayed only srt, txt, smi, ssa and sub.
4. If there is no information or there is a code that can not read in the DivX file, " 1 " etc are displayed.

Zoom function

Use zoom to enlarge the video image.

- 1 During playback, press the ZOOM key on the remote.



The square frame appears briefly in the right bottom of the picture.

Each press the key switches the mode.

- 1 200% size
- 2 400% size
- 3 900% size
- 4 normal size

- 2 Press the Cursor (◀/▶/▲/▼) keys on the remote to move through the zoomed picture.

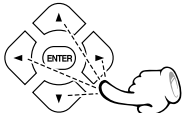

- To resume normal playback, press ZOOM or CLEAR key repeatedly.



1. Zoom may not work on some DVDs.
2. Screen fit mode is available for playing the DVD disc and movie file.

3D Surround

To produce a 3D surround effect that simulates multi-channel audio from two stereo speakers.

- 1 During playback, press the ON SCREEN key on the remote.



- 2 Press Cursor up/down (▲/▼) keys on the remote to select the sound option.

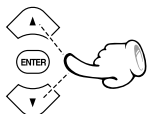

Sound icon



- The sound option will be highlighted.

- 3 Press Cursor left/right (◀/▶) keys on the remote to select "3D SUR".

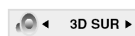
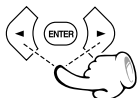

- To turn off the 3D Surround effect, select "Normal".

Time Search

To start playing at any chosen time on the disc.

- 1 During playback, press the ON SCREEN key on the remote.



The time search box shows the elapsed playing time.

- 2 Press Cursor up/down (▲/▼) keys on the remote to select the time clock icon.

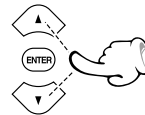

Time clock icon

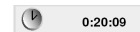

- ":-:--" appears.

- 3 Input the required start time in hours, minutes and seconds from left to right.

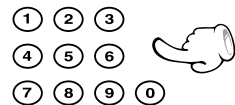

- If you enter the wrong numbers, press CLEAR to remove the numbers you entered. Then input the correct numbers.

- 4 Press ENTER to confirm.



- Playback starts from the selected time.

Music disc playback features

Using the TV screen to start playback

Once you insert an audio CD, MP3 or WMA disc a menu appears on the TV screen.

Audio CD menu

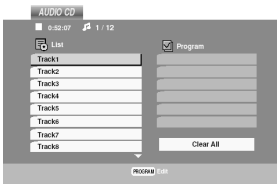

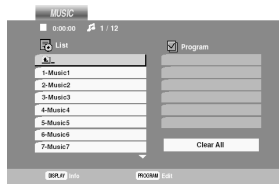

MP3/WMA menu

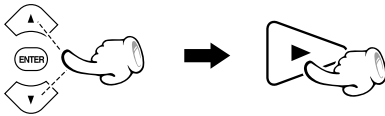

Press the Cursor up/down (▲/▼) keys on the remote to select a track then press PLAY (▶) or ENTER and playback starts.



Playback from desired track

Press the numeric keys, then press PLAY (▶) key.
(Example) To select track No. 23 :  

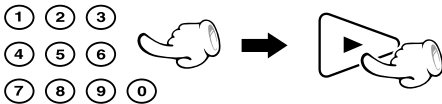

3D Surround

To produce a 3D surround effect that simulates multi-channel audio from two stereo speakers.

During playback, press the AUDIO key on the remote.



- "3D SUR." appears on the menu screen.
- To turn off the 3D Surround effect, press **AUDIO** key repeatedly until "3D SUR." disappears from the menu screen.

To display the ID3 tag

When playing a file containing information such as track titles, you can see the information by pressing ON SCREEN key.

Press the ON SCREEN key on the remote to display the ID3 tag.

Song, Artist, Album, Comment and Genre display appears on the TV screen.

ON SCREEN



Each press the key switches the mode.



- If there is no information, "No ID3 Tag Info" appear on the display.

Random play

The tracks of the disc are played in random order.

During playback, press the RANDOM key on the remote.

The Random Play display appears on the TV screen.

RANDOM



- Each time you press **RANDOM** key on the remote, random play would be on and off.
- By pressing **▶▶** key during random playback, the unit selects another track and resumes random playback.

To cancel random play

1 Press the stop (■) key to stop playback.

2 Press the RANDOM key to cancel random playback.

To repeat random play (repeat play →)

During random playback, press the REPEAT key on the remote.

REPEAT



Each press the key switches the mode.

- 1 "TRACK"
- 2 "ALL"
- 3 Goes off (repeat off)



After all tracks of a disc have been played in random order, playback will stop.

Photo files playback features (JPEG files only)

To start playback → 23

Once you insert an audio JPEG disc a menu appears on the TV screen.

- Press the Cursor up/down (▲/▼) keys on the remote to select a folder then press ENTER key.
- A list of files in the folder appears. If you are in a file list and want to return to the previous Folder list, use the Cursor up/down (▲/▼) keys on the remote to highlight  and press ENTER key.
- Select desired file, then press PLAY or ENTER key.

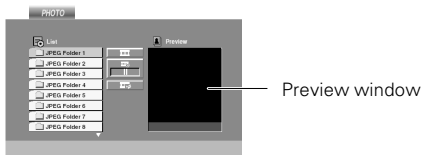

Zoom function

Use zoom to enlarge the photo image.

- During playback, press the ZOOM key on the remote.

Each press of the key switches the mode.



- 200% size
- 400% size
- 900% size
- normal size

The square frame appears briefly in the right bottom of the picture.

- Press the Cursor (◀/▶/▲/▼) keys on the remote to move through the zoomed picture.

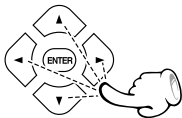

- To resume normal playback, press ZOOM or CLEAR key repeatedly.

To rotate picture

Press the Cursor up/down (▲/▼) keys on the remote to rotate the picture clockwise or counter clockwise.

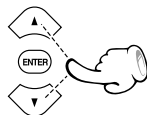

To hide the menu bar

Press the RETURN (⌂) key on the remote to hide the menu bar.



Switching between display and no display is done each time the RETURN key is pressed.

Slide show

The Slide show function can be used to switch photo images automatically from one file to the next. There are 3 Slide speed options.

- Insert a disc and close the tray.
 - Press Cursor (◀/▶/▲/▼) keys on the remote to highlight the speed icon .
- Go to step 4 if the slide speed is not to be changed.



- Press Cursor left/right (◀/▶) keys on the remote to select the option you want to use then press ENTER key.

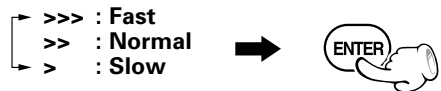

- Press Cursor up/down (▲/▼) keys on the remote to select the  icon and then press the ENTER key.

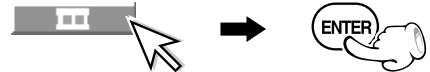

- Playback starts.

In case of difficulty

What appears to be a malfunction may not always be serious. If your unit should not perform as expected, consult the table below to see if the problem can be corrected before seeking help from your dealer or service representative.

Operation to reset

The microprocessor may fall into malfunction (impossibility to operate erroneous display, etc.) when the power cord is unplugged while power is ON or due to an external factor.
In this case, switch off the power, wait for several seconds, and then switch the power on again.

DVD player unit

Symptom	Cause	Remedy
Playback does not start when the ► key is pressed.	<ul style="list-style-type: none"> There is no disc in the player. There are no signals recorded on the side of the disc being played. 	<ul style="list-style-type: none"> Load a disc and press the ► key. Turn the disc over and properly place it on the disc tray.
Playback starts but no image/sound is seen heard.	<ul style="list-style-type: none"> The TV is not turned on. The connection cords are not properly connected. 	<ul style="list-style-type: none"> Turn on the TV. Properly reconnect the connection cords. → [12] → [13]
The picture is disrupted when the image is fast forwarded or fast reversed.	<ul style="list-style-type: none"> The picture is slightly disrupted during fast forward and fast reverse operations. 	<ul style="list-style-type: none"> This is not a malfunction.
No sound is heard.	<ul style="list-style-type: none"> The audio output cords are not properly connected. The volume control of the TV or amplifier is not adjusted properly. The player is in a special playback mode. 	<ul style="list-style-type: none"> Properly connect the audio cords. → [12] → [13] Set the sound volume to an appropriate level. Press the ► (play) key to resume normal playback mode.
No picture is displayed.	<ul style="list-style-type: none"> Setting to progressive mode has been done for a TV not compatible with progressive mode. 	<ul style="list-style-type: none"> Return to interlaced mode is made when the ■ (stop) key is pressed for at least 5 seconds.
The picture does not look good or the picture/sound quality is poor.	<ul style="list-style-type: none"> A nearby device is generating noise. The disc is dirty. The disc is damaged. There is condensation on the optical lens. 	<ul style="list-style-type: none"> Separate this unit as far as possible from the device you think is generating the noise. Refer to the "Disc handling precautions" section and wipe dirt from the disc. → [11] Use a new disc. Refer to the "Caution on condensation" section and evaporate the condensation. → [11]
It takes a while for the disc to start playing.	<ul style="list-style-type: none"> Time is required for the unit to detect the disc type and size and for the rotation of the motor to stabilize. This is not a malfunction. 	<ul style="list-style-type: none"> Approximately 10 to 20 seconds are required for a disc to start playing, although the time differs depending on the disc.
The tray opens automatically.	<ul style="list-style-type: none"> The disc is not placed horizontally. 	<ul style="list-style-type: none"> Properly place the disc on the tray.
The top and bottom of the screen cannot be seen, or the screen becomes black-and-white.	<ul style="list-style-type: none"> The video format of the disc being played does not match that of the connected TV monitor. 	<ul style="list-style-type: none"> Refer to the "Video formats" section and use a disc with the appropriate video format for your TV or a TV with the appropriate video format for the disc. → [10]
The subtitle is not displayed.	<ul style="list-style-type: none"> The DVD disc being played does not contain the recording of subtitles. The subtitle mode is set to off. 	<ul style="list-style-type: none"> The subtitle cannot be displayed when the DVD disc being played does not contain the recording of subtitles. Press the SUBTITLE key to switch on the subtitle mode. → [29]
The voice (or subtitle) language cannot be changed.	<ul style="list-style-type: none"> The DVD disc being played does not contain the recording of more than one audio (or subtitle) language. 	<ul style="list-style-type: none"> The voice (or subtitle) language cannot be changed when the DVD disc being played does not contain the recording of more than one voice (or subtitle) language.
The viewing angle cannot be changed.	<ul style="list-style-type: none"> The DVD disc being played does not contain the recording of more than one angle. You are attempting to switch the angle in a DVD section where more than one angle is not recorded. 	<ul style="list-style-type: none"> The viewing angle cannot be changed when the DVD disc being played does not contain the recording of more than one angle. More than one viewing angle may be recorded only in limited sections in a disc.

DVD player unit (Continued)

Symptom	Cause	Remedy
Playback will not start even after a title is selected.	<ul style="list-style-type: none"> A viewing restriction (Rating) has been set for the disc. 	<ul style="list-style-type: none"> Check the viewing restriction level (Rating) setting. → [18]
The parental level cannot be changed.	<ul style="list-style-type: none"> You have forgotten the password. 	<ul style="list-style-type: none"> Set the initial setup to the factory setup with the following procedure. <ol style="list-style-type: none"> Press the SETUP key on the remote to display the Setup menu. Input the 6-digits number "210499" and the password is cleared. Enter a new code. → [19]
The voice or subtitle language selected in the initial setting is not played.	<ul style="list-style-type: none"> The DVD disc being played does not contain the recording of the selected voice or subtitle language. The initial playback language is specified by the DVD disc. The DVD specifications provide for selection at the menu screen. 	<ul style="list-style-type: none"> Use a DVD disc containing the recording of the selected voice or subtitle language. Press SUBTITLE or the AUDIO key on the remote and select the language. → [28] → [29] Select at the menu screen of the disc.
Menu screen messages are not shown in the desired language.	<ul style="list-style-type: none"> The menu language function (MENU) is not set to desired language. 	<ul style="list-style-type: none"> Select disc menu language. → [17]
A VCD cannot be played using menus.	<ul style="list-style-type: none"> The VCD disc being played is not compatible with P.B.C. 	<ul style="list-style-type: none"> Menu playback is available only with VCD discs recorded with P.B.C.

Remote control unit

Symptom	Cause	Remedy
Remote control operation is not possible.	<ul style="list-style-type: none"> Batteries are exhausted. The remote control is too far away from the system, the controlling angle is deviated or there is an obstacle in between. 	<ul style="list-style-type: none"> Replace with new batteries. Operate the unit inside the remote controllable range.

Inhibition icon

Symptom	Cause	Remedy
 <p>The inhibition icon is displayed and remote control is not possible.</p>	<ul style="list-style-type: none"> Playback is restricted intentionally by the software producer. 	<ul style="list-style-type: none"> The operation is inhibited. Please try another operation.

This product incorporates copyright protection technology that is protected by U.S. patents and other intellectual property rights. Use of this copyright protection technology must be authorized by Macrovision, and is intended for home and other limited viewing uses only unless otherwise authorized by Macrovision. Reverse engineering or disassembly is prohibited.

CONSUMERS SHOULD NOTE THAT NOT ALL HIGH DEFINITION TELEVISION SETS ARE FULLY COMPATIBLE WITH THIS PRODUCT AND MAY CAUSE ARTIFACTS TO BE DISPLAYED IN THE PICTURE. IN CASE OF 525 OR 625 PROGRESSIVE SCAN PICTURE PROBLEMS, IT IS RECOMMENDED THAT THE USER SWITCH THE CONNECTION TO THE "STANDARD DEFINITION" OUTPUT. IF THERE ARE QUESTIONS REGARDING OUR TV SET COMPATIBILITY WITH THIS MODEL 525P AND 625P DVD PLAYER, PLEASE CONTACT OUR CUSTOMER SERVICE CENTER.

Manufactured under license from Dolby Laboratories. "Dolby" and the double-D symbol are trademarks of Dolby Laboratories.

"DTS" and "DTS Digital Out" are registered trademarks of Digital Theater Systems, Inc.



DivX, DivX Certified, and associated logos are trademarks of DivX, Inc. and are used under license.

Specifications

[Type]		[Video Section]	
System	DVD video player	Video output format	
Signal read system	Semiconductor laser	Europe and Australia	NTSC/PAL
		Except for Europe and Australia	NTSC
[D/A Conversion Section]		Video compression	
D/A conversion	24 Bit	DVD	MPEG-2
Oversampling ... 8 fs (Sampling frequency; 44.1, 48 kHz)		Composite video output level	1 Vp-p (75 Ω)
..... 4 fs (Sampling frequency; 96 kHz)		S-video output level (Except for Europe)	
		(Y-signal)	1 Vp-p (75 Ω)
		(C-signal)	
		NTSC	0.286 Vp-p (75 Ω)
		PAL	0.300 Vp-p (75 Ω)
[Audio section]		Component Video output level	
Frequency response		(Y-signal)	1 Vp-p (75 Ω)
Sampling frequency ; 44.1 kHz	4 Hz ~ 20 kHz	(Cb-signal)	0.7 Vp-p (75 Ω)
Sampling frequency ; 48 kHz	4 Hz ~ 22 kHz	(Cr-signal)	0.7 Vp-p (75 Ω)
Sampling frequency ; 96 kHz	4 Hz ~ 44 kHz	RGB output level (SCART) (For Europe)	0.7 Vp-p (75 Ω)
Signal to noise ratio	More than 100 dB	Horizontal resolution	More than 500 lines
Dynamic range	More than 92 dB	Video signal to noise ratio	More than 68 dB
Total harmonic distortion	Less than 0.008 % (1 kHz)		
Channel separation	More than 95 dB (1 kHz)		
Wow and flutter	Below measurable limit		
Analog output level/impedance	2 V / 330 Ω		
Digital output level/impedance			
COAXIAL	0.5 Vp-p / 75 Ω		
		[General]	
		Power consumption	8 W
		Dimensions	W : 440 mm (17-5/16")
			H : 41 mm (1-5/8")
			D : 249 mm (9-13/16")
		Weight (net)	1.9 kg (4.2 lb)

 **KENWOOD follows a policy of continuous advancements in development. For this reason specifications may be changed without notice.**

- Sufficient performance may not be exhibited at extremely cold locations (Where water freezes).

KENWOOD

For your records

Record the serial number, found on the back of the unit, in the spaces designated on the warranty card, and in the space provided below. Refer to the model and serial numbers whenever you call upon your dealer for information or service on this product.

Model _____ Serial Number _____