

DAEWOO
ELECTRONICS



HDMI DVD PLAYER

INSTRUCTION MANUAL



DV-2500H



ENGLISH



TABLE OF CONTENTS

IMPORTANT SAFETY PRECAUTIONS	2	PLAYING A DESIRED SCENE.....	21
FEATURES	5	To skip scenes in a disc.....	21
ABOUT DISCS	6	Directly moving to a desired title (DVD/VCD) .	21
BEFORE OPERATION.....	8	Playing a disc containing MP3 (or CD) files	22
PREPARATIONS BEFORE OPERATION. 10		Repeat Play	22
Front Panel	10	Repeating a defined period from A to B	23
Rear Panel	11	Select a Subtitle Language	23
VFD.....	12	Searching.....	24
Names and Layout of Remote Controls	13	PLAY DISCS IN VARIOUS WAYS	25
CONNECTIONS	14	Select Angle.....	25
BASIC OPERATIONS.....	15	Zoom Play.....	25
Play Discs	15	Book Mark.....	26
System Setting.....	16	Program Play (DVD).....	27
V-Mode	16	Program Play (VCD).....	28
USB/CARD	16	Digest Play (VCD)	29
Display.....	17	Playing DivX disc on CD-R (W)	29
Fast Play	18	Kodak Picture CD mode.....	30
Slow Play	18	FUNCTION SETTING	32
Pause/ Step.....	18	Menu Setting.....	32
Select Audio Language.....	19	Language.....	34
Select Channels	19	Video	36
Select 3D Audio	19	Audio	37
MICROPHONE CONTROL.....	20	Parental	39
Microphone Set up	20	OTHERS	40
		Troubleshooting	40
		Technical Specifications.....	41

IMPORTANT SAFETY PRECAUTIONS

	CAUTION RISK OF ELECTRIC SHOCK DO NOT OPEN	
<p>CAUTION: TO REDUCE THE RISK OF ELECTRIC SHOCK, DO NOT REMOVE COVER (OR BACK). NO USER-SERVICEABLE PARTS INSIDE. REFER SERVICING TO QUALIFIED SERVICE PERSONNEL.</p>		



The lightning flash with arrowhead symbol, within an equilateral triangle, is intended to alert the user to the presence of uninsulated "dangerous voltage" within the product's enclosure that may be of sufficient magnitude to constitute a risk of electric shock.



The exclamation point within an equilateral triangle is intended to alert the user to the presence of important operating and servicing instructions in the literature accompanying the appliance.

WARNING : TO REDUCE THE RISK OF FIRE OR ELECTRIC SHOCK, DO NOT EXPOSE THIS APPLIANCE TO RAIN OR MOISTURE.

CAUTION : TO PREVENT ELECTRIC SHOCK, MATCH WIDE BLADE OF PLUG TO WIDE SLOT, FULLY INSERT.

IMPORTANT FOR LASER PRODUCTS

- **LASER :** This Digital Video Disc Player employs a Laser System. To ensure proper use of this product please read this owner's manual carefully and retain for future reference. Should the unit require maintenance, contact an authorized service location - see service procedure.

Use of control adjustments or the performance of procedures other than those specified may result in hazardous radiation exposure.

To prevent direct exposure to the laser beam, do not try to open the enclosure. Visible laser radiation when open and interlocks defeated.

DO NOT STARE INTO THE BEAM.

- **DANGER :** Visible laser radiation when open and interlock failed or defeated. Avoid direct exposure to beam.
- **CAUTION :** Do not open the top cover. There are no user serviceable parts inside the Unit; leave all servicing to qualified service personnel.

CLASS 1
LASER PRODUCT

CAUTION: Any changes or modification in construction of this device which are not expressly approved by the party responsible for compliance could void the user's authority to operate the equipment.

ATTENTION: KEEPING THE STATUS OF STOP MORE THAN 5 MINUTES ENTERS SCREEN SAVE MODE. WHEN THE SCREEN SAVE MODE IS KEPT MORE THAN AN HOUR, THE SET ENTERS STAND-BY MODE.

MACROVISION

This product incorporates copyright protection technology that is protected by U.S. patents and other intellectual property rights. Use of this copyright protection technology must be authorized by Macrovision, and is intended for home and other limited viewing uses only unless otherwise authorized by Macrovision. Reverse engineering or disassembly is prohibited.

IMPORTANT SAFETY PRECAUTIONS

This set has been designed and manufactured to assure personal safety. Improper use can result in electric shock or fire hazard. The safeguards incorporated in this unit will protect you if you observe the following procedures for installation, use and servicing. This unit is fully transistorized and does not contain any parts that can be repaired by the user.

1 READ INSTRUCTIONS

All the safety and operating instructions should be read before the unit is operated.

2 RETAIN INSTRUCTIONS

The safety and operating instructions should be retained for future reference.

3 HEED WARNINGS

All warnings on the unit and in the operating instructions should be adhered to.

4 FOLLOW INSTRUCTIONS

All operating and use instructions should be followed.

5 CLEANING

Unplug this unit from the wall outlet before cleaning. Do not use liquid cleaners or aerosol cleaners. Use a damp cloth for cleaning.

6 ATTACHMENTS/ACCESSORIES

Do not use attachments unless recommended by the unit's manufacturer as they may cause hazards.

Caution : Apparatus shall not be exposed to dripping or splashing and no objects filled with liquids, such as vases, shall be placed on the apparatus.

7 WATER AND MOISTURE

Do not use this unit near water- for example, near a bath tub, wash bowl, kitchen sink or laundry tub, in a wet basement, or near a swimming pool.

8 PLACEMENT

Do not place this unit on an unstable cart, stand, tripod, bracket, or table. The unit may fall, causing serious injury to a child or adult as well as serious damage to the unit. Use this unit only with a cart, stand, tripod, bracket, or table recommended by the manufacturer.

*PORTABLE CART WARNING
(symbol provided by RETAC)*



8A

A unit and cart combination

should be moved with care. Quick stops, excessive force, and uneven surfaces may cause the video product and cart combination to overturn.

9 VENTILATION

Slots and openings in the case are provided for ventilation to ensure reliable operation of the unit and to protect it from overheating. These openings must not be blocked or covered. These openings must not be blocked by placing the unit on a bed, sofa, rug, or other similar surface. This unit should never be placed near or over a radiator or heat radiator. This unit should not be placed in a built-in installation such as a bookcase or rack unless proper ventilation is provided or the manufacturer's instructions have been adhered to.

10 POWER SOURCES

This unit should be operated only from the type of power source indicated on the marking label. If you are not sure of the type of power supply to your home, consult

your video dealer or local power company. For units intended to operate from battery power, or other sources, refer to the operating instructions.

11 GROUNDING OR POLARIZATION

This unit is equipped with a polarized alternating - current line plug (a plug having one blade wider than the other). This plug will fit into the power outlet only one way.

This is a safety feature. If you are unable to insert the plug fully into the outlet, try reversing the plug. If the plug still fails to fit, contact your electrician to replace your obsolete outlet. To prevent electric shock, do not use this polarized plug with an extension cord, receptacle, or other outlet unless the blades can be fully inserted without blade exposure. If you need an extension cord, use a polarized cord.

12 POWER-CORD PROTECTION

Power-supply cords should be routed so that they are not likely to be walked on or pinched by items placed upon or against them, paying particular attention to cords at plugs and the point where they exit from the unit.

13 LIGHTNING

For added protection for this unit during a lightning storm, or when it is left unattended and unused for long periods of time, unplug it from the wall outlet and

IMPORTANT SAFETY PRECAUTIONS

disconnect the antenna or cable system. This will prevent damage to the unit due to lightning and power line surges.

14 DISC TRAY

Keep your fingers well clear of the disc as it is closing. It may cause serious personal injury.

15 OVERLOADING

Do not overload wall outlets or extension cords as this can result in a risk of fire or electric shock.

16 OBJECT AND LIQUID ENTRY

Never press objects of any kind into this unit through openings as they may touch dangerous voltage points or "short-out" parts that could result in a fire or electric shock. Never spill liquid of any kind on the unit.

17 BURDEN

Do not place a heavy object on or step on the product. The object may fall, causing serious personal injury and serious damage to the product.

18 DISC

Do not use a cracked, deformed or repaired disc. These discs are easily broken and may cause serious personal injury and product malfunction.

19 SERVICING

Do not attempt to service this unit yourself as opening or removing covers may expose you to dangerous voltage or other hazards. Refer all servicing to qualified service personnel.

20 DAMAGE REQUIRING SERVICE

Unplug this unit from the wall outlet and refer servicing to qualified service personnel under the following conditions.

- A. When the power-supply cord or plug is damaged.
- B. If liquid has been spilled, or objects have fallen into the unit.
- C. If the unit has been exposed to rain or water.
- D. If the unit does not operate normally by following the operating instructions. Adjust only those controls that are covered by the operating instructions. Improper adjustment of other controls may result in damage and will often require extensive work by a qualified technician to restore the unit to its normal operation.

E. If the product has been dropped or the cabinet has been damaged.

F. When the unit exhibits a distinct change in performance-this indicates a need for service.

21 REPLACEMENT PARTS

When replacement parts are required, have the service technician verify that the replacements he uses have the same safety characteristics as the original parts. Use of replacements specified by the unit manufacturer can prevent fire, electric shock, or other hazards.

22 SAFETY CHECK

Upon completion of any service or repairs to this unit, ask the service technician to perform safety checks recommended by the manufacturer to determine that the unit is in safe operating condition.



23 WALL OR CEILING MOUNTING

The product should be mounted to a wall or ceiling only as recommended by the manufacturer.

24 HEAT

The product should be situated away from heat sources such as radiators, heat registers, stoves, or other products (including amplifiers) that produce heat.

FEATURES

- ④ **HDMI**
Audio/Video Digital output support 1080I (Interlace), 720P (Progressive) and 480P/576P Video out.
- ④ **OUTSTANDING SOUND QUALITY**
Dolby Digital  system developed by Dolby Laboratories and DTS  developed by DTS Inc., features high quality surround sound which can be played in DVD or CD disc at home, to reproduce high quality sound effects.
- ④ **HIGH DEFINITION**
The unit adopts MPEG2 coding format and brings the high horizontal resolution.
- ④ **UNIQUE FUNCTIONS**
Multi-angle and multi-language bring unique trick functions.
Parent lock makes it easy to control the content of discs.
- ④ **SCREEN**
Ordinary screen and wide screen (16:9) are available.
- ④ **COMPATIBILITY**
The unit can play DVD-video discs, and is compatible with CD, CD-G, CD-R, CD-RW, PIC-CD, MP3, DVD-R, DVD-RW, DVD+RW.
- ④ **ZOOM**
It can enlarge pictures.
- ④ **MULTI-FUNCTIONS**
Fast forward, fast reverse, forward and reverse slow, frame play, repeat play and program play.
- ④ **TIME SEARCH**
It can search a specific part on a disc, especially good for watching movies.
- ④ **RESUME PLAY**
It can memorize the position where the disc is stopped and resume playback.
- ④ **VIDEO OUTPUT**
Standard video, S-video output, RGB, HDMI Video mode.
- ④ **AUDIO OUTPUT**
HDMI/ Analog audio output, coaxial and optical digital audio output, can be connected with the appropriate amplifier to enjoy high-quality sound effects.
- ④ **KARAOKE**
Dual-Microphone input, KARAOKE channel selection.

ABOUT DISCS

PRINCIPLES FOR WRITING

This manual mainly introduces how to use buttons on the remote control.
You may operate the unit if the buttons on the unit have the same or similar names as or to those on the remote control.

PLAYABLE DISCS

DVD-video	Region number 2 or Region number ALL
DVD-R/+R	DVD video
DVD-RW/+RW	DVD video
DVD-ROM	DVD video
CD-G	Playback audio/ graphic files
CD-DA	Digital audio files
CD-R/ CD-RW	Digital audio/ MP3/ JPEG format files
CD-DA/JPEG/MP3	Total disc capacity : over 4M, Each file : under 1M
CD-ROM	Digital audio/ MP3/ JPEG format files

NONE PLAYABLE DISCS

DVD-video	Different region number
DVD-ROM	Files for PC application / Data files
CD-ROM	Files for PC application / Data files
CD-MP3	Files under windows format
DVD-RAM	All format

STRUCTURE OF DVD

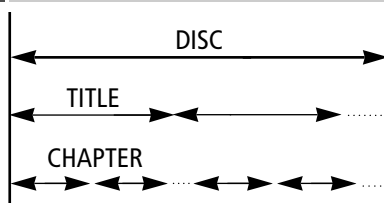

STRUCTURE OF CD

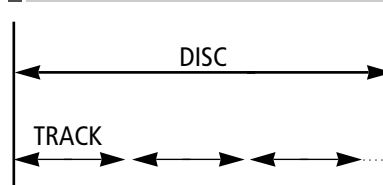

TITLE

The images or music of a DVD are divided into some units, among which title is the biggest one.

When playing a DVD, the movie is the title.

When playing a CD, the combined tracks make up the title.

ABOUT DISCS

CHAPTER

It is smaller than title among the units of a DVD. A title is made up of several chapters, and each chapter has a number for search. But some discs may not have numbered chapters.

TRACK

In a CD, each track has a number to enable search functions.

SCENE

The menu pictures, motion and motionless pictures of a CD can be divided into some parts, these parts are scenes. Each scene has a number for search.

REGION MANAGEMENT INFORMATION

This unit is designed and manufactured to respond to the Region Management information that is recorded on a DVD disc. The region number of this player is "2". If the region number described on the DVD discs does not correspond to the Region number of this player, the player will not play this disc. This player will play DVD discs made for "ALL" regions. Therefore, this player will play DVD discs marked with labels containing the region number "2" or "ALL".



(Region 2)



(Region ALL)

BEFORE OPERATION

SECURITY

- Before operation, check if the voltage of the unit is in line with the local voltage.
- Hold the plug to disconnect it from the mains outlet. Do not pull the power cord.
- When the plug of the unit is connected to the mains outlet, the unit will be still connected to AC even if the power is turned off.
- Disconnect the plug as soon as liquid or objects enter the unit. The unit can not be used until being checked by experts.
- Do not open the cabinet as laser rays employed by the unit may damage eyes. Any servicing should be done by qualified service personnel.

PLACEMENT

- Put the unit where ventilation is good enough to prevent overheating.
- Never put the unit in direct sunlight or near heat sources.
- Put the unit horizontally, never put any heavy object on the unit.
- To protect the pickup, do not put the unit where there is dust. If there is dust on the pickup, use a cleaning disc to clean it. Paying particular attention to the operating instructions of the cleaning disc.

CONDENSATION

Moisture will appear on the pickup lens in the following cases:

- The unit is suddenly moved from a cold place to a warm place.
- The unit is put in a room with a heater, or in cold air from an air-conditioner.
- Using the unit in a humid place. In these cases, the unit can not work. Unload the disc and leave the unit on for about one hour to evaporate the moisture.

CLEANING

- Use a soft cloth with a little neutral detergent to wipe the cabinet, panel and controls.
Never use abrasive paper, polishing powder, solvent like alcohol or gasoline.

HANDLING DISC





- To keep the disc clean, do not touch the playsides of the disc.
- Do not attach paper or tape to the disc.
- Keep the disc away from direct sunlight or heat sources.
- Store the disc in a disc case after playback.

CLEANING DISC

- Before playback, wipe the disc outward from the centre with clean cloth.
- Do not use any type of solvent such as thinner, benzene, commercially available cleaners or antistatic spray.

BEFORE OPERATION**CHECK ACCESSORIES**

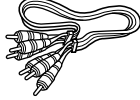
Check if you have all the accessories after the carton is opened.

Remote control	AAA batteries	Video/Audio cord	Instruction manual
			

USE REMOTE CONTROL

- 1 Open the battery compartment.
- 2 Insert two AAA batteries, make sure to match "+" and "-" of the batteries to the marks in the battery compartment.
- 3 Close the battery compartment.
- 4 Point the remote control at the remote sensor.

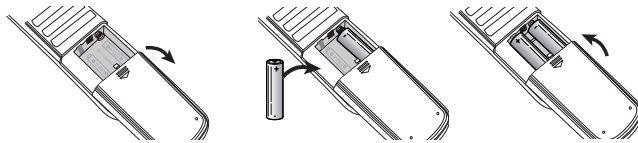
**Note:**

1. Batteries can last for about 6 months generally. Change the batteries if that does not work.
2. If the remote control is not used for a long time, remove the batteries to prevent battery leakage.

PREPARATIONS BEFORE OPERATION

FRONT PANEL



- ① **STANDBY/ON button**
To switch the unit On or Off when connected to AC power outlet
- ② **OPEN/CLOSE button**
To open or close the disc tray.
- ③ **PLAY button**
To play the loaded disc. Press this button to go to the preferred item when the menu is displayed on the TV screen.
- ④ **STOP**
- ⑤ **PREV button**
To skip back from the current chapter or track.
- ⑥ **NEXT button**
To skip forward to the next chapter or track.
- ⑦ **Microphone Jack 1 & 2**
- ⑧ **Microphone volume adjustment knob.**
- ⑨ **Microphone Echo adjustment knob.**
- ⑩ **REMOTE SENSOR**
Receives a light signal from the remote control.
- ⑪ **DISPLAY**
Displays operation status.
- ⑫ **USB port**

PREPARATIONS BEFORE OPERATION

REAR PANEL

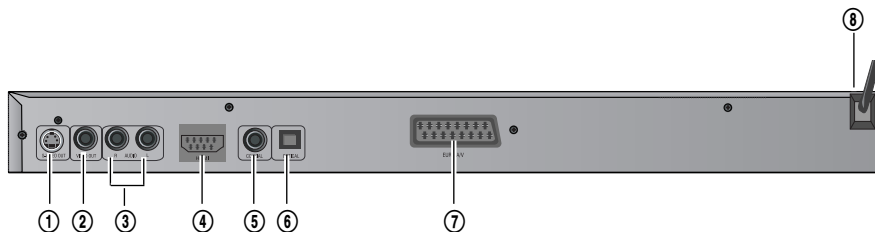

① S-VIDEO OUTPUT

Connects to TV or monitor equipped with S-VIDEO input. In order to achieve a sharper and cleaner picture than when connected via VIDEO OUT (composite video).

② VIDEO OUT

Connects composite video signal to input AV or PHONO sockets of TV or monitor to achieve high fidelity colour reproduction.

③ AUDIO OUT (L/R TRACK)

Two phono sockets for analogue 2 Channel audio in order to a TV or stereo amplifier.

④ HDMI

Audio/Video High definition multimedia digital output terminal.

⑤ DIGITAL AUDIO COAXIAL OUT

Connects digital audio under play mode into an AV amplifier or a receiver equipped with digital audio decoder for you to enjoy the theatre-quality sound in your home.

⑥ DIGITAL AUDIO OPTICAL OUT

Connects digital audio under play mode into an AV amplifier or a receiver equipped with digital audio decoder for you to enjoy the theatre-quality sound in your home.

⑦ EURO AV JACK

If VIDEO OUT phono is not utilized, the SCART socket can be used to connect to a TV set, monitor or VCR.

⑧ POWER SUPPLY SOCKET WIRE

Creates POWER between wall outlet and the unit.

PREPARATIONS BEFORE OPERATION

VFD

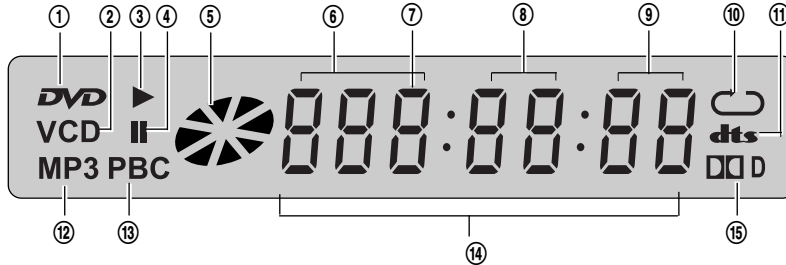

- | | |
|--|--|
| <p>① Recognized DISC TYPE indicator
: DVD</p> <p>② Recognized DISC TYPE indicator
: VCD</p> <p>③ PLAY indicator</p> <p>④ PAUSE indicator</p> <p>⑤ DISC LOAD/PLAY indicator
This indicator is lit up after recognizing the disc.</p> <p>⑥ DVD/CD/MP3 indicator
Indicates the title, chapter or track number.</p> <p>⑦ DVD/CD/MP3 indicator
Indicates the hour.</p> <p>⑧ DVD/CD/MP3 indicator
Indicates the minutes.</p> <p>⑨ DVD/CD/MP3 indicator
Indicates the seconds.</p> <p>⑩ REPEAT MODE indicator
 : In case you want to play a chapter, track, title or disc repeatedly.</p> <p>⑪ DVD AUDIO STREAM indicator
: dts digital out</p> | <p>⑫ Recognized DISC TYPE indicator
: MP3</p> <p>⑬ PBC indicator
This indicator is lit up in selecting PBC ON while this indicator disappears in selecting PBC OFF.</p> <p>⑭ NUMBER/ CHARACTER indicator
Chapter, track number, and time are displayed in loading DVD/CD disc, while track number and time are displayed in loading MP3.

 <i>OPEN</i> : Tray is opened
 <i>CLOSE</i> : Tray is closed
 <i>LOAD</i> : Disc is loaded
 <i>NO DISC</i> : There is no disc in tray
 <i>ERROR</i> : Disc has some error</p> <p>⑮ DVD AUDIO STREAM indicator
Indicates the audio type of the disc under playing is DOLBY DIGITAL.</p> |
|--|--|

PREPARATIONS BEFORE OPERATION

NAMES AND LAYOUT OF REMOTE CONTROLS

* After setting the mode by using SETUP menu (for example, NTSC select in NTSC/PAL/AUTO setup), the setting is kept though you switch the unit off and turn it on.

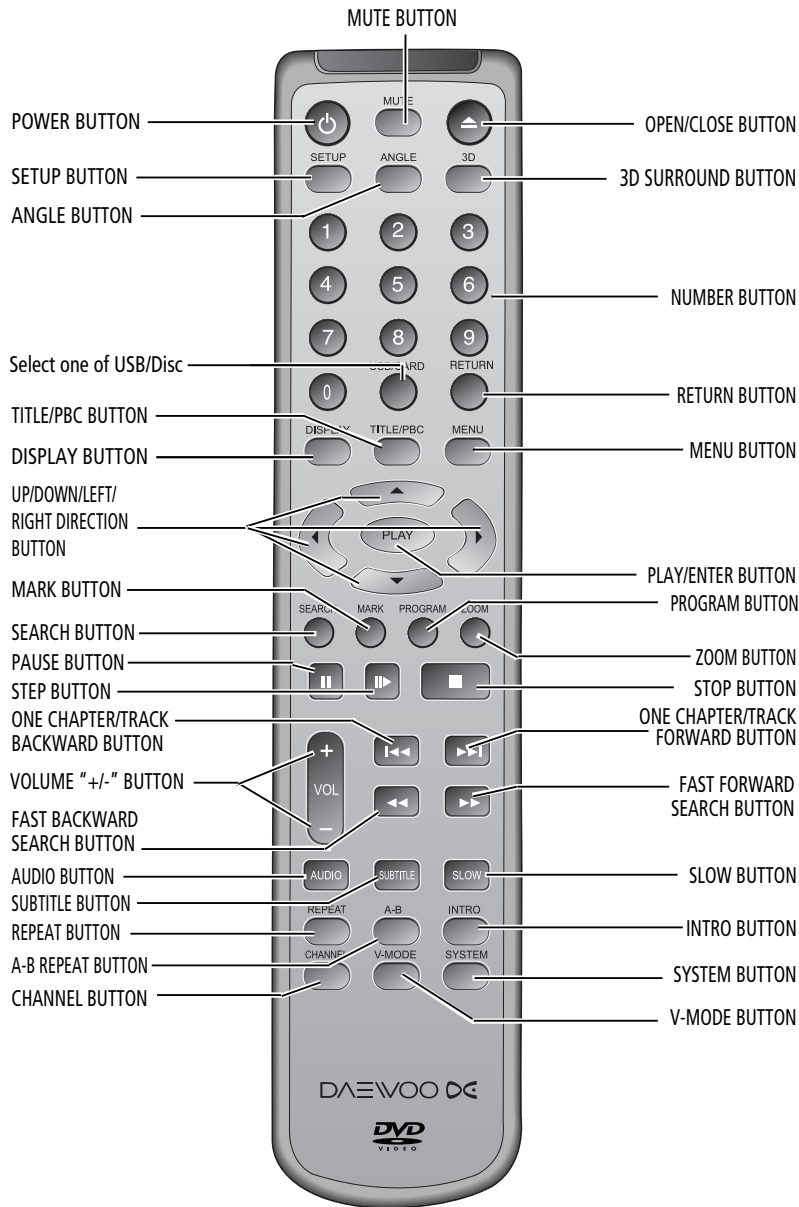

CONNECTIONS

Turn off all equipment before operation.

The unit has many kinds of output modes like A/V output, S-VIDEO output and digital signal output (COAXIAL, OPTICAL). You may select as you need.

CONNECTED TO A TV AND AN AUDIO AMPLIFIER

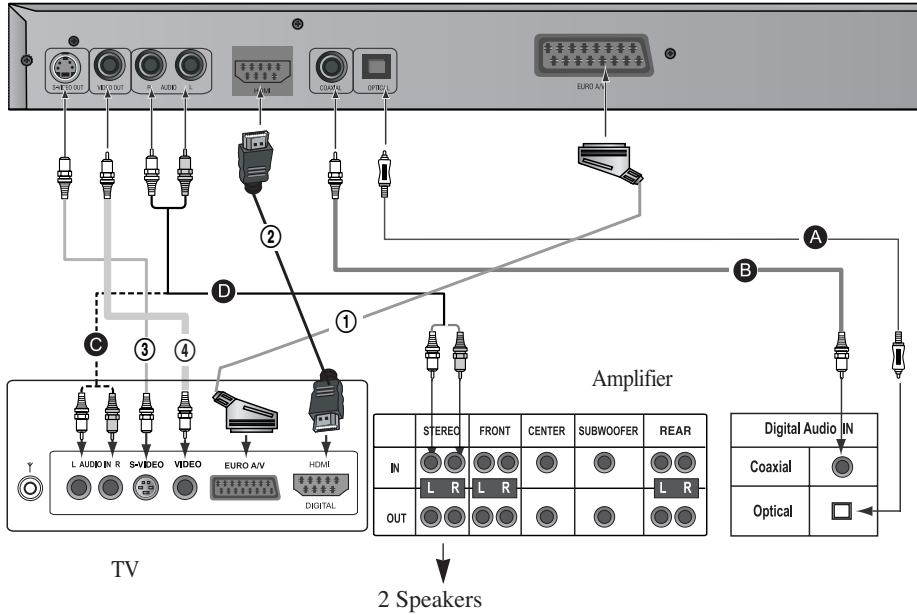

Manufactured under license from Dolby Laboratories. "Dolby" and the double-D symbol are trademarks of Dolby Laboratories. Confidential Unpublished works.
 ©1992-1997 Dolby Laboratories, Inc. All rights reserved.
 "DTS" and "DTS Digital Out" are trademarks of Digital Theater Systems, Inc.

BASIC OPERATIONS

PLAY DISCS

- 1 Press "POWER" button on the TV and audio system, Press "TV/VIDEO" button on the TV, select VIDEO mode (TV).

Select S-Video mode if using an S-VIDEO connection.

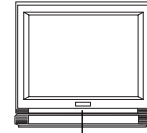

TV/VIDEO

- 2 Select the correct audio input on the amplifier.

- Each amplifier is different from another, please refer to the manual for the amplifier. (e.g., connect the audio output of the DVD player to the DVD audio input of an amplifier.)

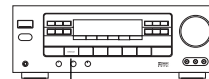

DVD/LD

- 3 Press "STAND BY/ON" button on the front panel or "⏻" button on the remote control to turn the unit on.

- 4 Press "OPEN/CLOSE ▲" button to open the disc tray and insert the disc with its label upward. Press "OPEN/CLOSE ▲" button again to close the disc tray. The unit begins to read the disc. The TV screen shows the DVD menu and title menu.

- When playing a DVD, DVD menus and titles are displayed on TV screen.
- In the case of CD, the disc plays in order of its track number.

- 5 Stop playback.
Press ■.

- 6 Press ▲ to remove the disc.

Note:

The Step2 can be cancelled if you do not connect it to the amplifier.

BASIC OPERATIONS

SYSTEM SETTING

According to the system of the TV to be connected, set the system of the unit to make it match the TV.

In STOP mode, press SYSTEM button on the remote control, then choose TV TYPE.

- When you press the [SYSTEM] button, the TV screen shows the information as : "Press [SYSTEM] button again." Press the [SYSTEM] button again, the video out system changes as follows.



SYSTEM





V-MODE (WHEN SELECTING CVBS/RGB/HDMI)

- In case of connecting the component, press the V-MODE on the remote control to select CVBS / RGB / HDMI. In case of selecting HDMI, S-VIDEO signal is not output.

When you press the [V-MODE] button, the TV screen shows the information as : "Press [V-MODE] button again." Press the [V-MODE] button again to change the video mode.

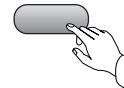
V-MODE



-  When you connect the Composite, picture is not displayed, press the V-MODE on the remote control to select Composite video.

USB/DISC

Choose one between USB and disc (You can select one only that is inserted in).

- After inserting USB, press USB/CARD button on the remote control to select one between USB and disc.
- When you press USB/CARD button, the TV screen shows :
DISC and USB
Move the cursor in the position of desired item by pressing [◀▶▲▼] button and press PLAY button.

USB/CARD

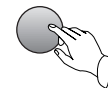

BASIC OPERATIONS

■ DISPLAY

Press the "DISPLAY" button when playing a disc, the TV screen shows the information as :

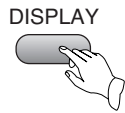

■ DVD

	Running Time	Remain Time
DVD Video	00:00:35	01:55:28
Title 1/7	Chapter 1/16	
Audio 1/2	6Ch Eng	
Subtitle Off		
Angle 1/1	Bitrate 6.632Mbps	

■ VCD

	Running Time	Remain Time
VCD 2.0	00:00:41	00:50:28
PBC On		

BASIC OPERATIONS

FAST PLAY

When playing disc, you may play it forward fast or reverse it fast to find what you need.

Note:

Press **PLAY** to play normally when playing fast.

1 Press **▶▶** to play forward fast. Each time you press the button, the speed of picture changes like the right sides.

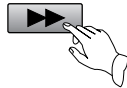

- ① ▶▶ X2
- ② ▶▶ X4
- ③ ▶▶ X8
- ④ ▶▶ X16

Note:

The marked **FAST PLAY** speed on owner's manual and real fast play speed can be different depending on which disc you play.

2 Press **◀◀** to reverse the disc fast. Each time you press the button, the speed of picture changes like the right sides.

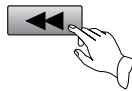

- ① ◀◀ X2
- ② ◀◀ X4
- ③ ◀◀ X8
- ④ ◀◀ X16

SLOW PLAY

Enjoy slow motions by the following steps.

Press "SLOW" button to play slowly.

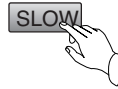

Note:

Press **PLAY** to play normally.

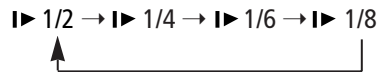

Note:

Press **PLAY** to play normally.

PAUSE/ STEP

Press **PAUSE** on the remote control to make the playback pause.

Pressing **STEP** again moves the picture forward frame by frame.

BASIC OPERATIONS

SELECT AUDIO LANGUAGE

You can choose the language according to your choice when playing multi-language DVD.

Press "AUDIO" button, select different languages.



Note:

1. Different disc has different languages
2. You can press "AUDIO" button to choose the language you want when you play multi-language DVD discs.

*Attention:

Please select the AUDIO language in SETUP menu to keep the setting!

SELECT CHANNELS (VCD only)

You may select the right channel or left channel or stereo from a multi-channel.

Press "CHANNEL" button, the screen show alternately and select the desired audio channel:

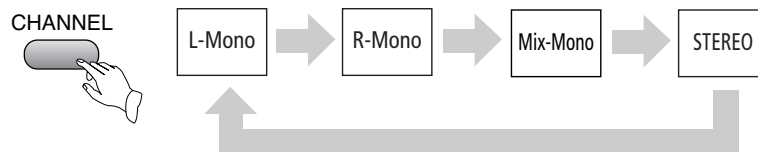

Note:

You can use channel function when you play the disc, you can choose mono audio output (left or right channel), stereo or mix-mono

SELECT 3D AUDIO

This function outputs 3D effects on the stereo audio analog output where 3D effects are broken down.

Press [3D] button.

Every time you press [3D] button, the 3D sound toggles between 3D on -> 3D off.

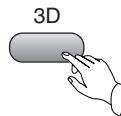

MICROPHONE CONTROL

MICROPHONE SET UP

- 1 Turn on Microphone Switch.
- 2 Connect the Microphone to the input socket on the front panel.



(not supplied)

- 3 Insert the Karaoke disc (label side uppermost) and select track to play.
- 4 Adjust the microphone level & echo on the front panel of DVD.



- 5 Select either the Left, Right, Mixed or Stereo mode, using channel button on the remote control.
- 6 Adjust to a comfortable volume using the volume (+/-) button on the remote control of the DVD player and the volume on the Monitor/TV.

PLAYING A DESIRED SCENE

■ TO SKIP SCENES IN A DISC

- 1 Press **▶▶** to move to the next chapter (or track).
The current chapter (or track) moves to the next chapter (or track).
- 2 Press **◀◀** to move to previous chapter (or track).
The current chapter (or track) moves to the previous chapter (or track) or first scene of current chapter (or track).

■ DIRECTLY MOVING TO A DESIRED TITLE (DVD/VCD)

Some movie discs may contain multiple titles. If the disc has a movie title menu recorded on it, the [TITLE/PBC] button can be used to select the movie title. Details of operation may differ depending on the disc used.

- 1 Press the [TITLE/PBC] or [MENU] button.
A list of the titles on the disc is displayed.
If using some disc, the menu screen will appear only when the disc has PBC function and PBC ON is activated.



Note:

You can select the desired title directly by using number button.

* In the case of PBC play, press RETURN to return to the sub-menu, press it again to return to the home menu.

- 2 Press the [PLAY] button after pressing the [**◀▶▲▼**] or number button to select the desired title.
The selected title now starts playing.

PLAYING A DESIRED SCENE

PLAYING A DISC CONTAINING MP3 (or CD) FILES

1 When a MP3 disc is loaded, MP3 menu screen is displayed automatically depending on MP3 disc's folder structure.

2 Use [◀▶▲▼] button to select the folder you want to play, and press the [PLAY] button.

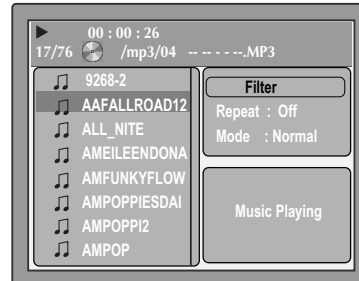

This button allows you to see the file lists under the folder.

3 Use [◀▶▲▼] button to select a MP3 file and press the PLAY button then play will start automatically. When you know the file number, enter the MP3 file number using the numeric buttons on the remote control and then press [PLAY] button.

4 Press ▶▶ on the remote control to choose next file. Press ◀◀ for previous file.

When you know the file number, enter MP3 file number using the numeric buttons on the remote control and then press [PLAY] button.

REPEAT PLAY

When play a disc, this function can be used to repeatedly play a title, chapter, track or disc.

Press "REPEAT" button, the screen shows orderly.

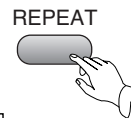

• DVD



• CD/ MP3

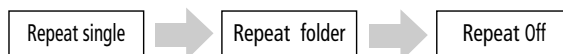

PLAYING A DESIRED SCENE

REPEATING A DEFINED PERIOD FROM A TO B

Note:

This function does NOT apply to MP3.

You may press A-B to enjoy some parts repeatedly when playing a disc.

1. Press "A-B" to set a starting point A.
2. Press "A-B" twice to an end point B.
Afterwards, the unit plays from A to B.
3. Press "A-B" three times to remove A-B repeat.

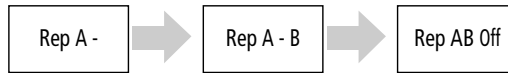
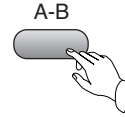

SELECT A SUBTITLE LANGUAGE

When play a multi-subtitle DVD, you may select one subtitle to show it on the screen.

Note:

1. For some discs, subtitles cannot be removed.
2. Subtitle function is only available for some discs with subtitle recorders.

- 1 Keep pressing [SUBTITLE] button till the user's preferred language appears.

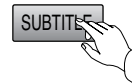

If a DVD disc includes subtitle information, every time the user presses [SUBTITLE] button, ENGLISH, FRENCH, SPANISH and others appear one by one.

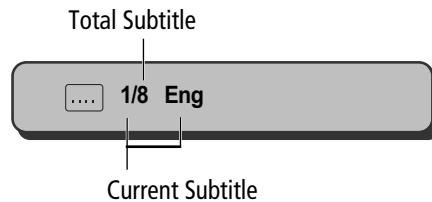

- 2 Remove the subtitle.

Press SUBTITLE until the screen shows "Off".

PLAYING A DESIRED SCENE

SEARCHING

SEARCHING DVD WITH A TITLE/CHAPTER NUMBER OR A TIME

Note:

- *SEARCH functionality depends on different DVD disc's format. Some DVD discs do not allow SEARCH function.*
- *SEARCH does NOT function during Program playback.*

- Using the SEARCH button you may play a disc at a desired Title, Chapter or Time.

Press the [SEARCH] button to select SEARCH mode.

Press ▲ or ▼ button to select title, chapter or time item.

Enter title number, chapter number or time by using numeric buttons directly and then press PLAY to confirm.

Search	
Title	---
Chapter	---
Time	--:--:--

SEARCHING CD WITH A DISC /TRACK TIME OR TRACK NUMBER

- Using the SEARCH button you may play a disc at a desired Track or Time.

Press the [SEARCH] button to select SEARCH mode.

Press ▲ or ▼ button to select track or time item.

Enter track number or time by using numeric buttons directly and then press PLAY to confirm.

Search	
Track	---
Time	--:--:--
Disc Time	--:--:--

PLAY DISCS IN VARIOUS WAYS

Note:

Multi Angle function is limited to a DVD disc supporting multi angle information.

SELECT ANGLE

Some discs have images with different screen angles, you may select among them. For example, when you watch a running train, you may select to watch it from the front, the left window or the right window without stopping it.

Keep pressing [ANGLE] button till the preferred angle appears.

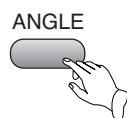

 Angle 2/4 (select ANGLE2)

 Angle 3/4 (select ANGLE3)

 Angle 4/4 (select ANGLE4)

ZOOM PLAY

This function can be used to enjoy a motion or motionless picture.

- 1 Press "ZOOM" button when playing, the screen shows orderly:

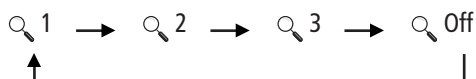
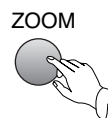

- 2 Press "UP/DOWN/LEFT/RIGHT" [◀▶▲▼] button to move the enlarged picture.

PLAYING A DESIRED SCENE

BOOK MARK

Note:

If you erase a book mark function, press "RETURN" button.

- Storing a MARKER in the DVD memory is similar to marking your page in a book. It allows you to quickly return to any point on the disc.

1 Storing a marker in the memory

Press MARK during playback mode and press PLAY at the starting point to be viewed (listened to) again.

Bookmark 1	--:--:--
Bookmark 2	--:--:--
Bookmark 3	--:--:--

Press ▲ or ▼ button to select another book mark item.

2 Recalling/ Clearing a marker

Press MARK during playback. Press ▲ or ▼ to select the marker to be recalled/ cleared.

Press PLAY to recall a marker. Or press RETURN to clear a marker. Play resumes from the point corresponding to the selected marker, or the selected marker is cleared.

PLAY DISCS IN VARIOUS WAYS

PROGRAM PLAY (DVD)

You may program the title and chapter on a disc and play them in the programmed order.

Note:

- Some DVD discs do not allow programming.

1 Press "PROGRAM" button, the screen shows:



2 Press ▲ or ▼ button to select the desired title number. Press PLAY. Then chapter screen appears. You can also select the desired chapter number by using ▲ or ▼ button. Press PLAY.

Note:

- You can clear all programmed item by press PLAY button on the position of "Clear All".
- You can clear from the latest programmed item by press PLAY button on the position of "Clear".

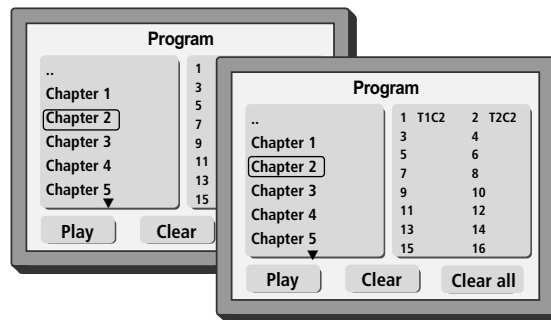

The selected title/chapter number will display at the right sides on the screen.

After the programming is finished, press direction [◀▶▲▼] button to select "Play", press "PLAY" button to start playing.

PLAY DISCS IN VARIOUS WAYS

PROGRAM PLAY (VCD)

You may program the track on a disc and play them in the programmed order.

Note:

- Single track disc can not be programmed.

1 Press "PROGRAM" button, the screen shows:

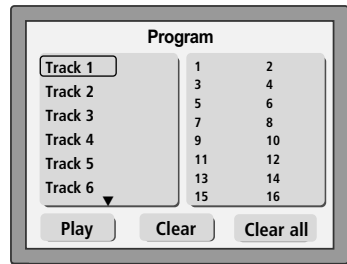

2 Press ▲ or ▼ button to select the desired track number. Press PLAY.

The selected track number will display at the right sides on the screen.

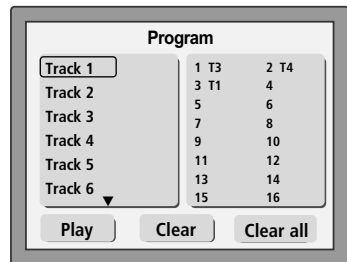

After the programming is finished, press direction [◀▶▲▼] button to select "Play", press "PLAY" button to start playing.

Note:

- You can clear all programmed item by press PLAY button on the position of "Clear All".
- You can clear from the latest programmed item by press PLAY button on the position of "Clear".

PLAY DISCS IN VARIOUS WAYS

DIGEST PLAY (VCD)

- 1 Each time you press INTRO button when the unit is playing a disc, digest playback mode changes as below.

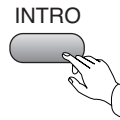

- 2 When you select "Intro on", the player will play 10 seconds each track.

PLAYING DivX DISC ON CD-R (W)

- DivX refers to a new format of Audio/Video files available for playback over the internet because of the popularity to download music from DivX websites on to ones computer.

- 1 When a DivX disc is loaded, the DivX menu screen is displayed automatically depending on DivX disc's folder structure.
- 2 Move the cursor to DivX file you want to play and press play button.
- 3 On your disc, if there are many subtitles, press the [SUBTITLE] button for selecting subtitle you want to display.



YOUR DVD PLAYER CAN PLAY;

- Picture DivX version: DivX 3.11, 4.x, 5.x, XviD, ISO-MPEG4, DivX PRO(**Excluding QPEL and GMC**)
- Subtitle file extension : It can support Smi, Srt, Sub, TXT.
- Subtitle Support language: It can display ENGLISH and some languages.

- Note:** • In order to recognize a DivX subtitle normally, the DivX subtitle language in Language menu should be set to the corresponding national language. (refer to "DivX subtitle" in page 34)

PLAY DISCS IN VARIOUS WAYS

■ Kodak Picture CD mode

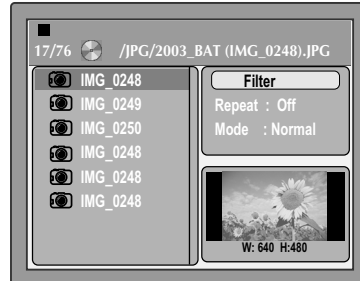

■ About Kodak Picture CD

A Kodak Picture CD has the size and shape of a regular CD. You can order a KODAK Picture CD simply by checking the box on the photo finishing envelope when you drop off a roll of film (35mm or Advanced Photo System (APS) color print film) at the time of processing in Kodak Express store displaying "Kodak Picture CD" sign. When your order is returned, you receive your prints, negatives, and your full roll of pictures safely stored on you KODAK Picture CD. Each KODAK Picture CD brings you the tools to enhance, share and manage your pictures on your computer. Now, you can playback Kodak Picture CDs on our DVD players and view your pictures on your TV in the comfort of your living room.

■ Playing back your Kodak Picture CD

The new feature enables the decoding of JPEG files from a Kodak Picture CD disk.

When a Kodak Picture CD has been loaded in the player, an automatic slide show will be launched.

Each picture in the Kodak Picture CD will be displayed consecutively in a slide-show fashion and will be scaled to fit in the whole TV screen.

Press PAUSE button to display an image indefinitely.

Press SKIP (◀▶) button to view the next or previous picture.

Press PLAY button to resume the slide show.

PLAY DISCS IN VARIOUS WAYS

■ Image rotation

Press ANGLE button to rotate a picture.

These operations are allowed only when a picture is being displayed normally and will be cancelled automatically when a new picture is displayed.

■ Zoom

Press ZOOM button to execute zoom function and select the zoom enlarging scale.

In zoom mode, Press [◀▶▲▼] button to move the picture, to adjust the picture to be displayed on the screen. With zoom mode off, the next picture will be scaled to normal fitting to the whole TV screen.

Press PLAY button to cancel the zoom and resuming to the slide show.

■ JPEG file format (limitations)

- JPEG file of CMYK color mode is not supported.
- The range of pixels should be not exceeding 3840 pixels x 3840 pixels, in order to achieve the best performance.

FUNCTION SETTING

MENU SETTING

Various features of the player can be adjusted in the SETUP menu:

1 SETUP button

Language

- OSD Language : English
- Subtitle : Off
- DivX subtitle : Western European
- Audio : Auto
- Disc Menu : Auto

Video

- TV Display : Normal LB
- TV Type : PAL
- Angle mark : Off
- Captions : Off
- Screen Saver : On
- HD Resolution : Auto
- HD JPEG mode : Off

Audio

- Digital Output : LPCM
- DownMix : LT/RT
- Dual Mono : Stereo
- Dynamic : Off

Parental

- Parental Control : Adult
- Set Password
- Use Default Settings

2 Play or ► button

OSD Language

- English
- Franglais
- Español
- Deutsch
- Italiano
- Nederlands
- Portuguese

TV Display

- Normal LB
- Normal PS
- 16:9 Wide

▲ or ▼

TV Type

- NTSC
- PAL
- AUTO

Digital Output

- Off
- LPCM
- Bitstream

Parental Control

Enter Password

FUNCTION SETTING

BASIC NAVIGATION

To navigation through the setting on the screen, use the direction [◀▶▲▼] buttons to scroll through the list of settings and use "PLAY" button to select the high lighted function.

SETUP MENU

Press the SETUP button to enter the On Screen Display and to exit at any time. In each of the menus, selecting MAIN PAGE (SETUP menu) will immediately return you to the initial screen.

<p>▲ or ▼ Subtitle</p> <ul style="list-style-type: none"> English Français Español Deutsch Italiano Nederlands Portuguese ✓ Off 	<p>▲ or ▼ DivX subtitle</p> <ul style="list-style-type: none"> Unicode (UTF-8) ✓ Western European Turkish Central European Cyrillic Greek Hebrew Arabic Baltic ▼ 	<p>▲ or ▼ Audio</p> <ul style="list-style-type: none"> English Français Español Deutsch Italiano Nederlands Portuguese ✓ Auto 	<p>▲ or ▼ Disc Menu</p> <ul style="list-style-type: none"> English Français Español Deutsch Italiano Nederlands Portuguese ✓ Auto
--	--	--	--

<p>▲ or ▼ Angle Mark</p> <ul style="list-style-type: none"> ✓ Off On 	<p>▲ or ▼ Captions</p> <ul style="list-style-type: none"> ✓ Off On 	<p>▲ or ▼ Screen Saver</p> <ul style="list-style-type: none"> Off ✓ On 	<p>▲ or ▼ HD Resolution</p> <ul style="list-style-type: none"> ✓ Auto 480P/576P 720P 1080i 1024x768 1366x768 	<p>▲ or ▼ HD JPEG mode</p> <ul style="list-style-type: none"> ✓ Off On
---	---	---	---	---

<p>▲ or ▼ DownMix</p> <ul style="list-style-type: none"> ✓ LT/RT Stereo 	<p>▲ or ▼ Dual Mono</p> <ul style="list-style-type: none"> ✓ Stereo L-Mono R-Mono Mix-Mono 	<p>▲ or ▼ Dynamic</p> <ul style="list-style-type: none"> ✓ Off On
--	---	--

<p>▶</p> <ul style="list-style-type: none"> 1. Kids Safe 2. G 3. PG 4. PG-13 5. PG-R 6. R 7. NC-17 ✓ 8. Adult 	<p>▲ or ▼ Set Password</p> <p>Enter New Password <input type="text" value=""/><input type="text" value=""/><input type="text" value=""/><input type="text" value=""/></p>	<p>▲ or ▼ Use Default Settings</p> <p>Yes <input type="button" value=""/> No <input type="button" value=""/></p>
---	--	---

FUNCTION SETTING

■ **Language**

Note:

"OSD" means
"On Screen
Display".

■ **OSD Language**

When select a language, the screen show this language.

For example, if you select ENGLISH, the OSD is in English.

■ **SUBTITLE**

• **Selecting Subtitle language.**

Please set it as the preferred language. In case the subtitle language is set and recorded in the DISC, it is automatically played in the set language in every playing. For example, English is set and recorded as subtitle language in the DISC, it is played in English.

■ **DivX SUBTITLE**

• **Selecting DivX Subtitle language.**

Please set it as the preferred language. In case the DivX subtitle language is set and recorded in the DISC, it is automatically played in the set language in every playing. For example, English is set and recorded as subtitle language in the DISC, it is played in English.

The default is Western European.

Each DivX subtitle option supports related languages as follows.

- Unicode (UTF-8): supports English, French, Spanish, German, Italian, Dutch and Portuguese. 7 kinds languages for DivX subtitle.
- Western European: supports Albanian, Breton, Catalan, Danish, Dutch, English, Faroese, Finnish, French, Gaelic, German, Icelandic, Irish, Italian, Norwegian, Portuguese, Spanish and Swedish.
- Turkish: supports Albanian, Danish, Dutch, English, Finnish, French, Gaelic, German, Italian, Kurdish (Latin), Norwegian, Portuguese, Spanish, Swedish and Turkish.
- Central European: supports Albanian, Croat, Czech, Dutch, English, German, Hungarian, Irish, Polish, Romanian, Slovak, Slovene and Sorbian.

FUNCTION SETTING

- Cyrillic: supports Bulgarian, English, Macedonian, Moldavian, Russian, Serbian and Ukrainian.
- Greek: supports English and modern Greek.
- Hebrew: supports English and modern Hebrew.
- Arabic: supports Arabic.
- Baltic: supports Baltic.
- Vietnam: supports Vietnamese.

■ AUDIO

- **Selecting an audio language.**

Set it as the preferred audio language. In case the audio language is set and recorded in the DISC, it is automatically played in the set language in every playing. For example, English is set and recorded as audio language in the DISC, it is played in English.

■ DISC MENU

- **Selecting Disc Menu language.**

Please set it as the preferred DISC MENU language. In case the DISC MENU language is set and recorded in the DISC, it is automatically played in the set language in every playing. For example, English is set and recorded as a DISC MENU language in the DISC, it is played in English.

FUNCTION SETTING

■ Video

■ TV DISPLAY

- 1 Normal PS**
This is selected when the unit is connected with a normal TV. Wide-screen images are shown on the screen, but with some parts cut automatically.



- 2 Normal LB**
This is selected when the unit is connected with a normal TV. Wide-screen images are shown on screen, with black belts on the top and bottom.

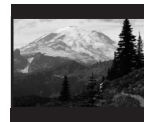

- 3 16:9 WIDE**
This is selected when the unit is connected with a wide-screen TV.



■ TV TYPE

You may select according to the colour system of the TV to be connected.

- Select "NTSC" for a NTSC TV.
- Select "PAL" for a PAL TV.
- Select "Auto" for a multi-system TV.

■ ANGLE MARK

This only works when there is an angle mark on the disc.

- Select "ON", the screen shows the mark when playing a DVD.
- Select "OFF", the mark is not shown.

FUNCTION SETTING

■ CAPTIONS

The hidden subtitle is shown or turn off.

■ SCREEN SAVER

Start the screen saver, the screen saver image appears when the unit stops or the image is motionless for a few seconds. This saver can keep the screen from being damaged.

■ HD Resolution

The HD Resolution menu enables you to select the desired HD Resolution used for the video output. There are five Resolution mode. The default is Auto.

■ HD JPEG MODE

Select HD JPEG mode to On or OFF.

■ **Audio**

■ DIGITAL Output

- **Bitstream**
Select this when the DVD player is connected with a power amplifier through optical or coaxial port. Please refer to the page 14. when a Dolby Digital DVD, DTS DVD or MPEG DVD is played, select this, the coaxial or optical port will output in the corresponding digital format (source code). The power amplifier to be connected must have Dolby Digital, DTS and MPEG DVD is played, the optical or coaxial port will output in PCM 2-channel format.
- **LPCM**
Select this when the DVD player is connected with a TV or a power amplifier through audio cord.
- **OFF**
No signal is output from the coaxial, optical port.

FUNCTION SETTING

■ Down Mix

Select Down Mix mode to LT/RT or Stereo.

■ Dual Mono

This is the output mode of the L and R signals of the set audio output. If it is set to "MIX MONO", the function only works when the DVD being played is 2.0-channel.

- **STEREO**
Choose this option, the audio output should be dummy stereo signal.
- **L-MONO**
- **R-MONO**
- **MIX-MONO**

■ Dynamic

Set "Off" to view a program in the dynamic range as recorded in disc. To hear loud sound softer and soft sound louder, set "On".
The default is Off.

FUNCTION SETTING

■ PARENTAL

■ PARENTAL CONTROL

Note:

The password is 3308 when the unit is turned on initially or you forget the password.

The Parental Control feature allows you to prevent DVDs from being played based on their ratings or to have certain discs played with alternative scenes. You can set the Rating Level from '1. Kid Safe' to '8. Adult'.

The content of a disc with lock function is evaluated by grades. You can select an age grade as your need.

Example: Select "1. Kid Safe", the scenes of violence inadvisable to children are not played.

For adults, the screen suggests you enter the code after pressing "PLAY" button, you can watch if the code is right.

Note:

The password is set by yourself.

■ SET PASSWORD

Select "SET PASSWORD" in Parental menu to setup password. Press PLAY button, then Enter password screen appears.

Input a password according to the screen.

Set Password

Enter New Password

■ Use Default Settings

Each function setting returns to the factory initial status if you select "Yes".

Use Default Settings

OTHERS

■ TROUBLESHOOTING

If you experience the following problems while using the unit, this troubleshooting guide can help you.

- **NO SOUND**

- Check if the unit is connected securely.
- Make sure you operate the TV or amplifier correctly.

- **NO IMAGE, IMAGE ROLLS AND NO COLOUR**

- Check if the unit is connected securely.
- Make sure you operate the TV correctly.
- Make sure you set the colour system correctly.

- **BAD SOUND QUALITY**

- Make sure the audio output mode is set correctly.
- Make sure the audio connection between the unit and amplifier is right.

- **DISC CAN NOT BE PLAYED**

- There is no disc in the unit.
- Insert the disc on the disc tray properly with the label side up.
- Clean the disc.
- Moisture has condensed in the unit.
Remove the disc and leave the unit on for about one hour.

- **NO MICROPHONE SOUND**

- Switch on the microphone.
- Turn the MIC LEVEL knob clockwise.

- **MICROPHONE DISTORTION**

- Keep the microphone far away from the speaker
- Turn down the volume
- Turn down the volume of microphone.

- **REMOTE CONTROL DOES NOT WORK**

- Remove barriers between the remote control and the unit.
- Replace the batteries with new ones.
- Point the remote control at the remote control sensor of the unit.

- **ATTENTION: KEEPING THE STATUS OF STOP MORE THAN 5 MINUTES ENTERS SCREEN SAVE MODE. WHEN THE SCREEN SAVE MODE IS KEPT MORE THAN AN HOUR, THE SET ENTERS STAND-BY MODE.**

OTHERS**TECHNICAL SPECIFICATIONS**

Laser		wavelength 650nm
Video		PAL/AUTO/NTSC
Frequency response		20Hz ~ 20KHz (± 1 dB)
Signal/noise ratio		≥ 90 dB
Channel separation		≥ 85 dB (1KHz)
Dynamic range		≥ 80 dB (1KHz)
Output Audio	Analog	output level : $2.0 + 0/-0.2$ Vrms (Load impedance : $1.0K\Omega$)
	Digital	output level : 0.5 ± 0.1 Vp-p (Load impedance : 75Ω)
Output Video	Composite	output level : 1.0 ± 0.1 Vp-p (Load impedance : 75Ω , imbalance, negative polarity)
	S-video	output level : brightness (Luma) 1.0 ± 0.1 Vp-p chromaticity (Color) $0.286 \pm 20\%$ (Load impedance : 75Ω)
	RGB	0.5 Vp-p 75% white
Input Terminals		USB slot (only USB Flash disc)
Power		$100-240V\sim$, 50Hz/60Hz 12W
Dimensions	Body (W x H x D)	430 x 43 x 263 mm
	Packing	492 x 100 x 372mm
Weight (Gross/ Net)		2.9Kg / 2.2Kg

Notes : Design and specifications in this instruction manual are subjected to change without prior notice to improve quality and function.