

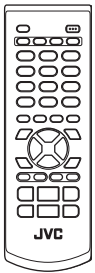

## DVD PLAYER

# XV-N315B/XV-N316S/ XV-N310B/XV-N312S/ XV-N210B/XV-N212S



### Region code of DVD VIDEO

This player can play back DVD VIDEO discs whose region code numbers include "2."

Examples of playable DVD VIDEO discs:



The player's region code is printed on the rear of the player.

**Before operation** 2

**Preparations** 4

**Basic playback** 9

**Various kinds of playback** 12

**Audio/Video files playback** 21

**Changing the initial settings** 25

**Additional information** 30

## INSTRUCTIONS

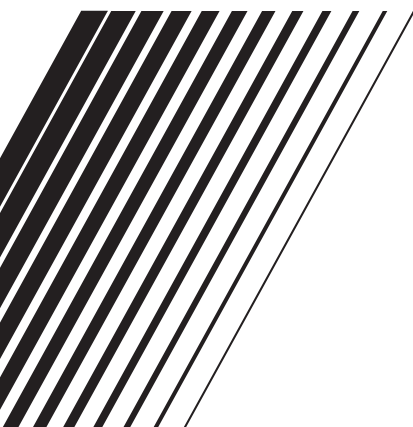

# Warnings, Cautions and Others

**IMPORTANT** for the U.K.

**DO NOT** cut off the mains plug from this equipment. If the plug fitted is not suitable for the power points in your home or the cable is too short to reach a power point, then obtain an appropriate safety approved extension lead or consult your dealer.

BE SURE to replace the fuse only with an identical approved type, as originally fitted.

If nonetheless the mains plug is cut off ensure to remove the fuse and dispose of the plug immediately, to avoid a possible shock hazard by inadvertent connection to the mains supply.

If this product is not supplied fitted with a mains plug then follow the instructions given below:

**IMPORTANT.**

**DO NOT** make any connection to the terminal which is marked with the letter E or by the safety earth symbol or coloured green or green-and-yellow.

The wires in the mains lead on this product are coloured in accordance with the following code:

Blue : Neutral  
Brown : Live

As these colours may not correspond with the coloured markings identifying the terminals in your plug proceed as follows:

The wire which is coloured blue must be connected to the terminal which is marked with the letter N or coloured black.  
The wire which is coloured brown must be connected to the terminal which is marked with the letter L or coloured red.

**IF IN DOUBT - CONSULT A COMPETENT ELECTRICIAN.**

## CAUTION

To reduce the risk of electrical shocks, fire, etc.:

1. Do not remove screws, covers or cabinet.
2. Do not expose this appliance to rain or moisture.

## Caution — STANDBY/ON button!

Disconnect the mains plug to shut the power off completely.

The  STANDBY/ON button in any position does not disconnect the mains line.

The power can be remote controlled.

## CAUTION

- Do not block the ventilation openings or holes.  
(If the ventilation openings or holes are blocked by a newspaper or cloth, etc., the heat may not be able to get out).
- Do not place any naked flame sources, such as lighted candles, on the apparatus.
- When discarding batteries, environmental problems must be considered and local rules or laws governing the disposal of these batteries must be followed strictly.
- Do not expose this apparatus to rain, moisture, dripping or splashing and that no objects filled with liquids, such as vases, shall be placed on the apparatus.

## Caution: Proper Ventilation

To avoid risk of electric shock and fire and to protect from damage, locate the apparatus as follows:

- Front: No obstructions and open spacing.  
Sides: No obstructions in 3 cm from the sides.  
Top: No obstructions in 5 cm from the top.  
Back: No obstructions in 15 cm from the back.  
Bottom: No obstructions, place on the level surface.

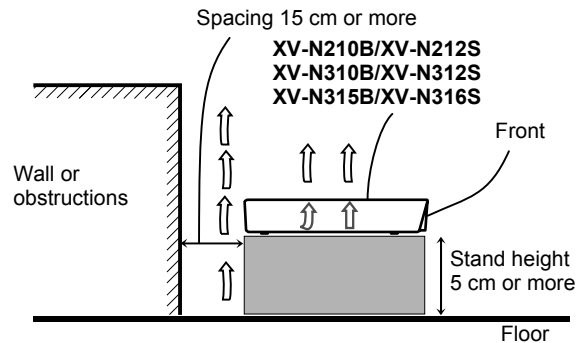

## IMPORTANT FOR LASER PRODUCTS

1. CLASS 1 LASER PRODUCT
2. **CAUTION:** Do not open the top cover. There are no user serviceable parts inside the unit; leave all servicing to qualified service personnel.
3. **CAUTION:** Visible and invisible laser radiation when open and interlock failed or defeated. Avoid direct exposure to beam.
4. REPRODUCTION OF LABEL: CAUTION LABEL, PLACED INSIDE THE UNIT.

<b>CAUTION</b> : Visible and invisible laser radiation when open and interlock failed or defeated. AVOID DIRECT EXPOSURE TO BEAM.	<b>ADVARSEL</b> : Synlig og usynlig laserstråling når maskinen er åpen eller interlocken fejler. Undgå direkte eksponering til strålingen.	<b>VARNING</b> : Synlig och osynlig laserstråling när den öppnas och spårren är urkopplad. Beträkta ej strålen.	<b>VARO</b> : Avattaessa ja suojauslaitos ohittetuna tai välillänsä olettamalla näkyväille ja näkymättömälle lasersträhtelylle. Vältä silmien kohdistumista suoraan lähteesi. (f)
---	--	---	---

## Supplied accessories

Check that you have all the following accessories supplied to you. If anything is missing, consult your dealer immediately.

- Remote control unit (× 1)
- Lithium battery CR2032 (× 1)

## About this manual

- The display window information and OSD (On Screen Display) menu items are put in brackets [ ] in the operation procedures.
- Usable disc(s) for each operation/function is (are) referred to by the icons;



## Precautions

### Notes on the power cord

- When you are away on travel or otherwise for an extended period of time, remove the plug from the wall outlet. A small amount of power (2.0W) is always consumed while the power cord is connected to the wall outlet.
- When unplugging the player from the wall outlet, always pull the plug, not the power cord.
- Do not handle the power cord with wet hands!

### Avoid moisture, water and dust

- Do not place the player in moist or dusty places.
- If water gets inside the player, turn off the power and remove the plug from the wall outlet, then consult your dealer. Using the player in this state may cause a fire or electrical shock.

### Avoid high temperatures

- Do not expose the player to direct sunlight or place it near a heating device.

### Notes on installation

- Select a place which is level, dry and neither too hot nor too cold between 5°C and 35°C.
- Leave sufficient distance between the player and the TV.
- Do not install the player in a place subject to vibrations.
- Do not put heavy objects on the player.

### To prevent malfunction of the player

- There are no user-serviceable parts inside. If anything goes wrong, unplug the power cord and consult your dealer.
- Do not insert any metallic objects, such as wires, hairpins, coins, etc. into the player.
- Do not block the vents. Blocking the vents may damage the player.

### To clean the cabinet

- Use a soft cloth. Follow the relevant instructions on the use of chemically-coated cloths.
- Do not use benzene, thinner or other organic solvents and disinfectants. These may cause deformation or discoloring.

## Table of contents

<b>Supplied accessories</b> .....	1
<b>About this manual</b> .....	1
<b>Precautions</b> .....	1
<hr/>	
<b>Before operation</b> .....	2
About discs .....	2
Names of parts and controls.....	3
<hr/>	
<b>Preparations</b> .....	4
Connections.....	4
Using the remote control unit.....	8
<hr/>	
<b>Basic playback</b> .....	9
Turning the player on and off.....	9
Initial setup .....	9
Starting playback .....	10
Restarting playback after stopping (resuming playback).....	11
<hr/>	
<b>Various kinds of playback</b> .....	12
Playback at various speeds .....	12
Locating the beginning of a scene or song .....	13
Playing from a specific position .....	13
Changing the playback order.....	14
Repeat playback .....	16
Changing the language, sound and scene angle .....	17
Special picture and sound effects.....	18
Menu bar functions .....	19
<hr/>	
<b>Audio/Video files playback</b> .....	21
Outline .....	21
Basic operations .....	22
Direct selection for JPEG files .....	22
Changing the playback order.....	23
Repeat playback .....	23
Slide show playback.....	23
Changing the picture of the opening display .....	24
<hr/>	
<b>Changing the initial settings</b> .....	25
Selecting preferences .....	25
Limiting playback by children.....	28
<hr/>	
<b>Additional information</b> .....	30
Troubleshooting .....	30
Specifications .....	31
Appendix A: Country/Area code list for Parental Lock.....	32
Appendix B: Table of languages and their abbreviations .....	33
Appendix C: Digital output signal chart.....	34
Appendix D: Glossary .....	35

# Before operation

## Digital audio formats

The player supports the following digital audio formats (see page 35 "Glossary" for descriptions of each audio format):

Linear PCM, MPEG Multichannel, Dolby Digital, DTS (Digital Theater Systems)

### NOTE

Depending on the player's [DIGITAL AUDIO OUTPUT] setting, digital audio signals may not be output as they are recorded on the disc. See "DIGITAL AUDIO OUTPUT" on page 27 for details.

## Notes on discs

- With some DVD VIDEO discs, the player starts playback automatically after inserting the disc.
- The image may be sometimes poor or noisy due to defects in the disc itself.
- With some discs, operations described in this manual may not be possible.

## Care and handling of discs

If a disc gets dirty, dusty, scratched or warped, playback sound and picture may be deteriorated. Take proper precautions when handling discs.

### Handling

- Do not touch the surface of the disc.
- Do not damage, stick paper to, or use any adhesive on either the label side or playback side.

### Storing discs

- Keep discs in their cases. If discs are piled on top of one another without their protective cases, they can be damaged.
- Do not put discs in a location where they may be exposed to direct sunlight, or where the humidity or temperature is high. Avoid leaving discs in a car!

### Cleaning discs

- Wipe with a soft dry cloth, moving from the center outwards. If a disc is difficult to clean, wipe with a cloth moistened with water.



- Never use record cleaners, petrol, alcohol or any anti-static agents.

### Notes on copyright

Check the copyright laws in your country before recording from DVD VIDEO, SVCD, Video CD, Audio CD, MP3, JPEG, and MPEG-4 discs.

Recording of copyrighted material may infringe copyright laws.

## About discs

### Playable disc types

Discs with the following marks can be played back on the player.

DVD VIDEO	SVCD	Video CD	Audio CD

The DVD Logo is a trademark.

The player can also play back the following discs:

- DVD-R and DVD-RW discs written in the DVD VIDEO format and finalized
- CD-R and CD-RW discs written in the SVCD, Video CD or Audio CD format and finalized
- CD-R and CD-RW discs written in MP3/JPEG/MPEG-4 in accordance with the "ISO 9660" format (See page 21 for details.)

### NOTE

If a disc gets dirty, scratched or warped, or due to the disc characteristics or recording conditions, it may take considerable time for the player to read the content, or the player may not be able to play back such discs.

The player can play back audio signals recorded in MIX-MODE CD, CD-G, CD-EXTRA and CD TEXT.

### Color system format

This player accommodates the PAL system, and also can play back discs recorded with NTSC system whose Region Code numbers include "2."

Note that the NTSC video signal on a disc is converted to a PAL signal and output.

### Unplayable discs

The player does not play back discs listed below. If you try to play back these discs, noise may generate causing damage to speakers.

- DVD-RW discs written in the VR format
- DVD-ROM, DVD-RAM, DVD AUDIO, CD-ROM, PHOTO CD, SACD

In addition, the player does not play:

- Unfinalized discs
- Discs of irregular shape or discs with tape, seals or paste on either the label side or playback side. Playing back these discs may damage the player.

# Names of parts and controls

## Front panel

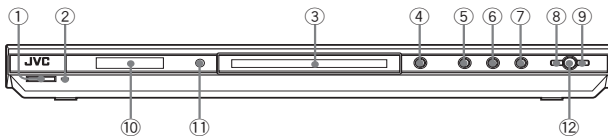

- ① STANDBY/ON button (9)
- ② STANDBY/ON indicator (9)
- ③ Disc tray (10)
- ④ button (10)
- ⑤ button (11, 13)
- ⑥ button (10, 13)
- ⑦ button (11, 12)
- ⑧ button (12, 13, 22)
- ⑨ button (12, 13, 22)
- ⑩ Display window (see the illustration below)
- ⑪ Remote sensor (8)
- ⑫ QUICK PLAYBACK button (12)

## Display window

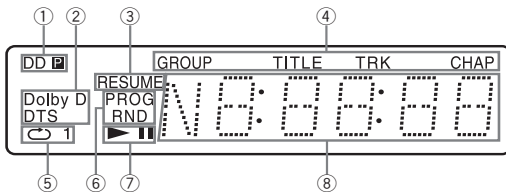

- ① **Progressive mode indicators**  
(for XV-N310B/XV-N312S/XV-N315B/XV-N316S)  
[P] turns on in the progressive scanning mode.  
[DDP] turns on depending on the [PICTURE SOURCE] preference setting and the source type of the current DVD VIDEO disc (see page 6 for details).
- ② **Dolby Digital/DTS indicators**  
[Dolby D] turns on when playing back a Dolby Digital sound source. [DTS] turns on when playing back a DTS-encoded digital sound source.
- ③ **Resume indicator**  
Turns on when playback is interrupted with the resume function activated.
- ④ **Group/title/track/chapter indicators**  
Show what is indicated by the multi-information display during playback.
- ⑤ **Repeat mode indicator**  
Turn on in the repeat playback mode and shows the currently selected repeat mode.
- ⑥ **Program/random indicators**  
Turn on in the program playback mode/random playback mode respectively.
- ⑦ **▶ (play)/|| (pause) indicators**  
Turn on in the playback mode/pause mode respectively.
- ⑧ **Multi-information window**  
Indicates various kinds of information by numbers and alphabets, such as the player's current status ("READ," "OPEN," etc.) or currently played DVD's title and chapter number.

# Remote control unit

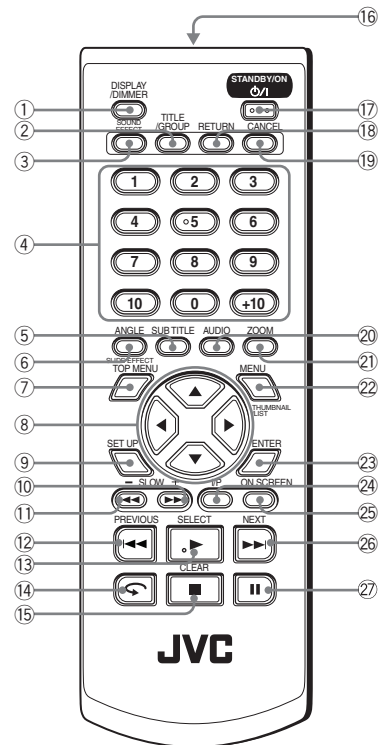

(Illustration: for XV-N310B/XV-N312S/XV-N315B/XV-N316S)

- ① **DISPLAY/DIMMER button**  
Press to change the display window contents.  
Press and hold to change the brightness of the display window. You can select the display window brightness from three levels. Release the button at the desired brightness.
- ② **TITLE/GROUP button** (14)
- ③ **SOUND EFFECT button** (19)
- ④ **Numeric buttons**
- ⑤ **SUBTITLE button** (17)
- ⑥ **ANGLE - SLIDE EFFECT button** (17, 24)
- ⑦ **TOP MENU button** (13)
- ⑧ **Cursor selection (▲ Up, ▼ Down, ◀ Left, ▶ Right) buttons**
- ⑨ **SET UP button** (10, 24, 25)
- ⑩ **▶▶/SLOW + button** (12)
- ⑪ **◀◀/SLOW - button** (12)
- ⑫ **◀◀/PREVIOUS button** (12, 13, 22)
- ⑬ **▶▶/SELECT button** (10, 22)
- ⑭ **↺ button** (12)
- ⑮ **■/CLEAR button** (11, 22)
- ⑯ **Infrared signal window** (8)
- ⑰ **STANDBY/ON button** (9)
- ⑱ **RETURN button** (13)
- ⑲ **CANCEL button** (14)
- ⑳ **AUDIO button** (17)
- ㉑ **ZOOM button** (18, 22)
- ㉒ **MENU - THUMBNAIL/LIST button** (13, 22)
- ㉓ **ENTER button**
- ㉔ **VFP button (for XV-N210B/XV-N212S) (18)**  
**VFP - I/P button (for XV-N310B/XV-N312S/XV-N315B/XV-N316S) (6, 18)**
- ㉕ **ON SCREEN button** (10, 14, 16, 19)
- ㉖ **▶▶/NEXT button** (12, 13, 22)
- ㉗ **|| button** (11, 24)

# Preparations

## Before making connections

- Do not connect the AC power cord until all other connections have been made.
- Connect VIDEO OUT of the player directly to the video input of your TV. Connecting VIDEO OUT of the player to a TV via a VCR may cause a monitor problem when playing back a copy-protected disc. You may also have a monitor problem when connecting the player to an integrated TV/Video system.

- In the following description, "TV" may be substituted with "monitor" or "projector."
- Terminal names used for other components may be different from those used in the following description.

## Connections

Before using the player, connect the player to a TV and/or amplifier.

### Connecting to a TV

#### Ⓐ Connecting to a TV with the SCART connector

You can enjoy using the player by simply connecting it to your television set with a 21-pin SCART cable.

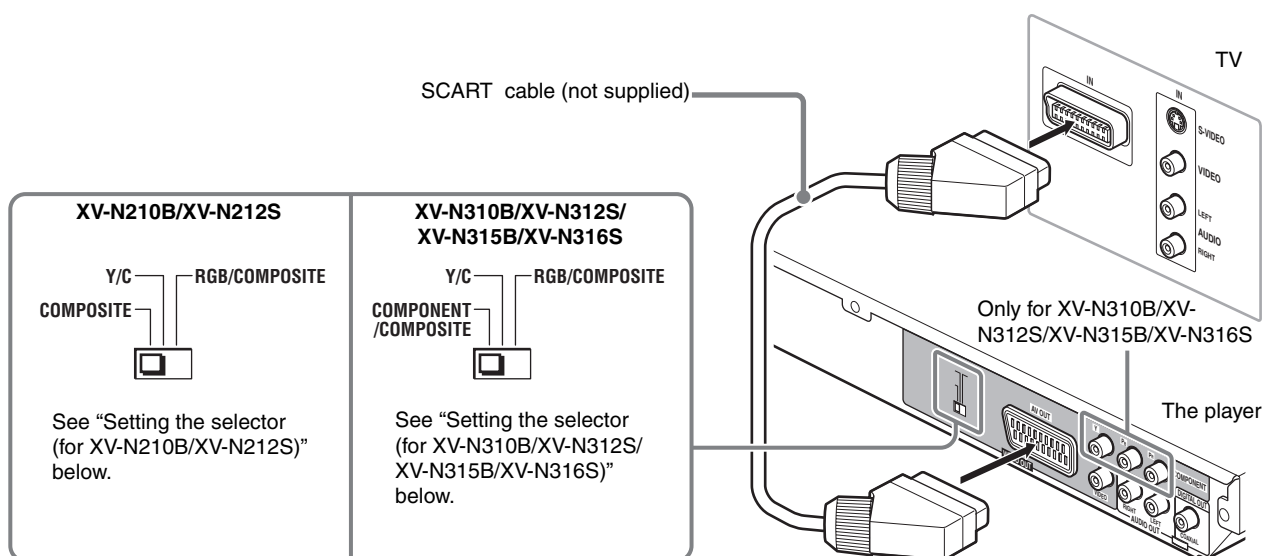

#### Setting the selector (for XV-N210B/XV-N212S)

When you connect the player to a TV with the SCART connector, set the COMPOSITE - Y/C - RGB/COMPOSITE selector correctly according to your TV.

- If your TV only accommodates the composite video signal: Set the selector to "COMPOSITE."
- If your TV accommodates Y/C signals: Set the selector to "Y/C" so you can enjoy better-quality pictures.
- If your TV accommodates RGB signals: Set the selector to "RGB/COMPOSITE."

#### Setting the selector (for XV-N310B/XV-N312S/XV-N315B/XV-N316S)

When you connect the player to a TV with the SCART connector, set the COMPONENT/COMPOSITE - Y/C - RGB/COMPOSITE selector correctly according to your TV.

- If your TV only accommodates the composite video signal: Set the selector to "COMPONENT/COMPOSITE" or "RGB/COMPOSITE."
- If your TV accommodates Y/C signals: Set the selector to "Y/C" so you can enjoy better-quality pictures.
- If your TV accommodates RGB signals: Set the selector to "RGB/COMPOSITE."

#### NOTE

Do not connect multiple devices using multiple connectors.

Ⓑ Connecting to a TV having composite video input jack

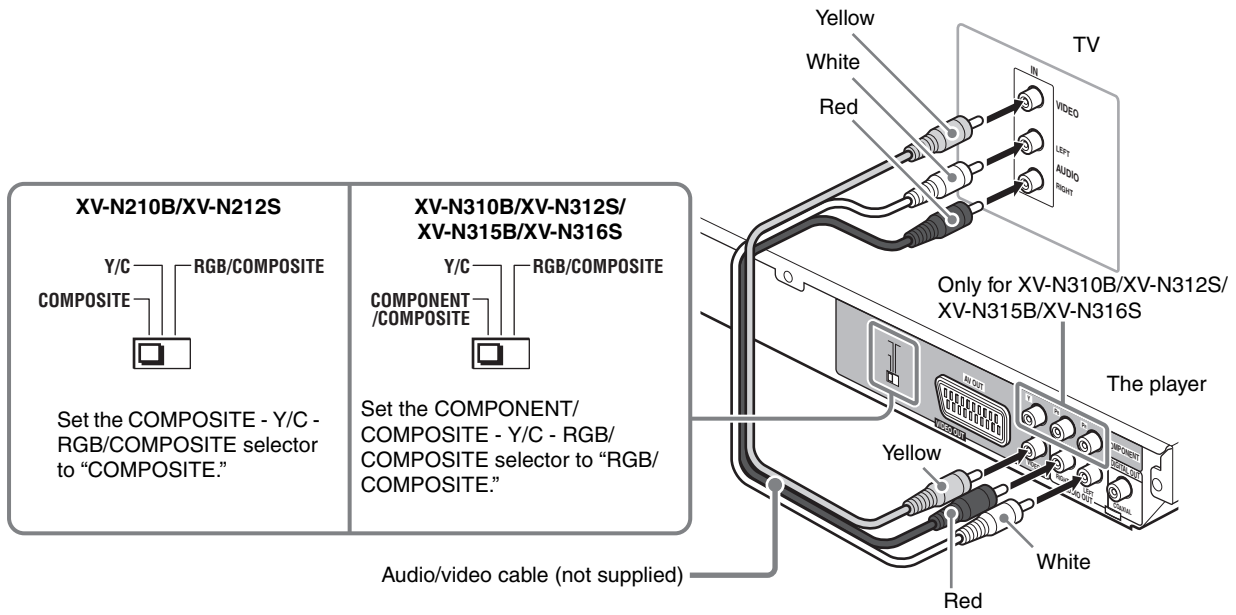

**NOTES**

- Do not connect multiple devices using multiple connectors.
- If your TV has a monaural audio input instead of stereo, you need to use an optional audio cable which converts stereo audio output to monaural.

### © Connecting to a TV with component jacks

**For XV-N310B/XV-N312S/XV-N315B/  
XV-N316S only**

You can enjoy picture of high-quality color reproduction by connecting the COMPONENT VIDEO OUT jacks on the player to your TV.

#### NOTES

- Connect "Y" to "Y," "P<sub>B</sub>" to "P<sub>B</sub>" (C<sub>B</sub>), "P<sub>R</sub>" to "P<sub>R</sub>" (C<sub>R</sub>) correctly.
- The video output jack, scart connector and component jacks cannot be used at the same time.
- If your TV has component video input jacks of BNC type, use an adapter which converts a pin jack to a BNC jack (not supplied).

#### Progressive scan video playback available

In the progressive scanning mode, you can enjoy high quality picture with less flickers when the COMPONENT VIDEO OUT jacks are connected to a TV or monitor that supports the progressive video input.

#### About the scanning mode

Depending on the material source format, DVD VIDEO discs can be classified into two types; film source and video source (note that some DVD VIDEO discs contain both film source and video source).

When the player plays back a film source material, uninterlaced progressive output signals are created using the original information. When a video source material is played back, the player interleaves lines between the interlaced lines on each to create the interpolated picture and outputs as the progressive signal.

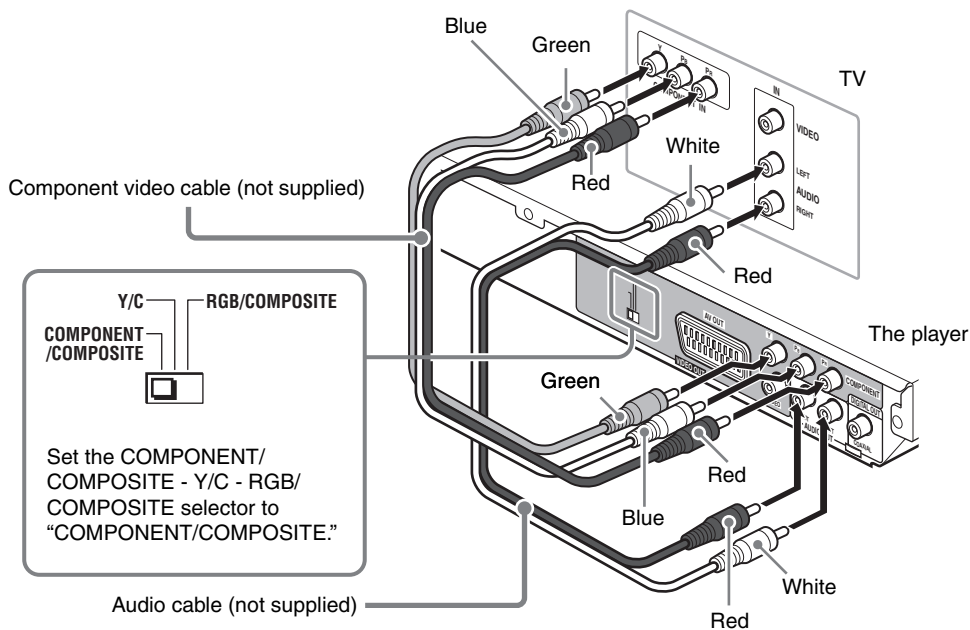

#### Activating the Progressive scanning mode

Press and hold down VFP - I/P on the remote control unit for a few seconds.

When the scanning mode is set to the Progressive mode, the [P] indicator lights up in the display window.

Depending on the [PICTURE SOURCE] preference display and whether the current DVD VIDEO disc is film-source or video-source, the indicator that lights up in the display window differs, as shown in the table below.

Setting of [PICTURE SOURCE]	Source type of DVD VIDEO	
	Film source	Video source
AUTO	[DDP]	[P]
FILM	[DDP]	[DDP]
VIDEO (NORMAL)/(ACTIVE)	[P]	[P]

#### NOTES

- The Progressive scanning mode works only when you connect the player's COMPONENT VIDEO OUT jacks to your TV.
- There are some progressive TV and High-Definition TV sets that are not fully compatible with the player, resulting in the unnatural picture when playing back a DVD VIDEO disc in the Progressive scanning mode. In such a case, use the Interlaced scanning mode. To check the compatibility of your TV set, contact your local JVC customer service center.
- All JVC progressive TV and High-Definition TV sets are fully compatible with the player (Example: AV-61S902).



## Connecting to optional audio equipment

### Connecting to a stereo audio amplifier/receiver

Connect the player's AUDIO OUT (LEFT/RIGHT) jacks to any line-level inputs (such as AUX, DVD, CD, etc.) of an audio amplifier or receiver.

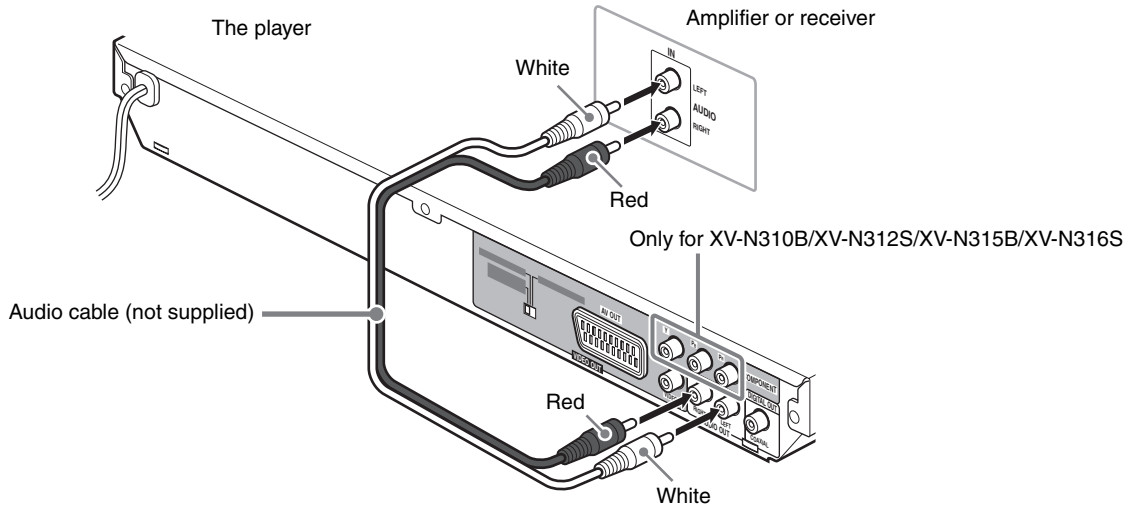

### Connecting to a digital audio device

You can enjoy sound of enhanced quality by connecting the player's DIGITAL OUT (COAXIAL) jack to a digital input of an amplifier, etc., using a or coaxial digital cable. The digital audio signal on a disc will be transferred directly from the player. If the connected digital audio equipment is a Dolby Digital or DTS decoder or an amplifier with a built-in decoder, you can enjoy high-quality surround sound.

#### NOTES

- It is not recommended to use the digital jacks for dubbing. When recording the sounds (DVD VIDEO, SVCD, Video CD or Audio CD) played back on the player, record them through the analog jacks.
- Depending on the disc, no signal may be output from the DIGITAL OUT. Make an analog connection in this case.
- **Set [DIGITAL AUDIO OUTPUT] in the [AUDIO] preference display correctly according to the connected digital audio equipment. If setting made for [DIGITAL AUDIO OUTPUT] is incorrect, loud noise may be generated causing damage to the speakers (see page 27).**

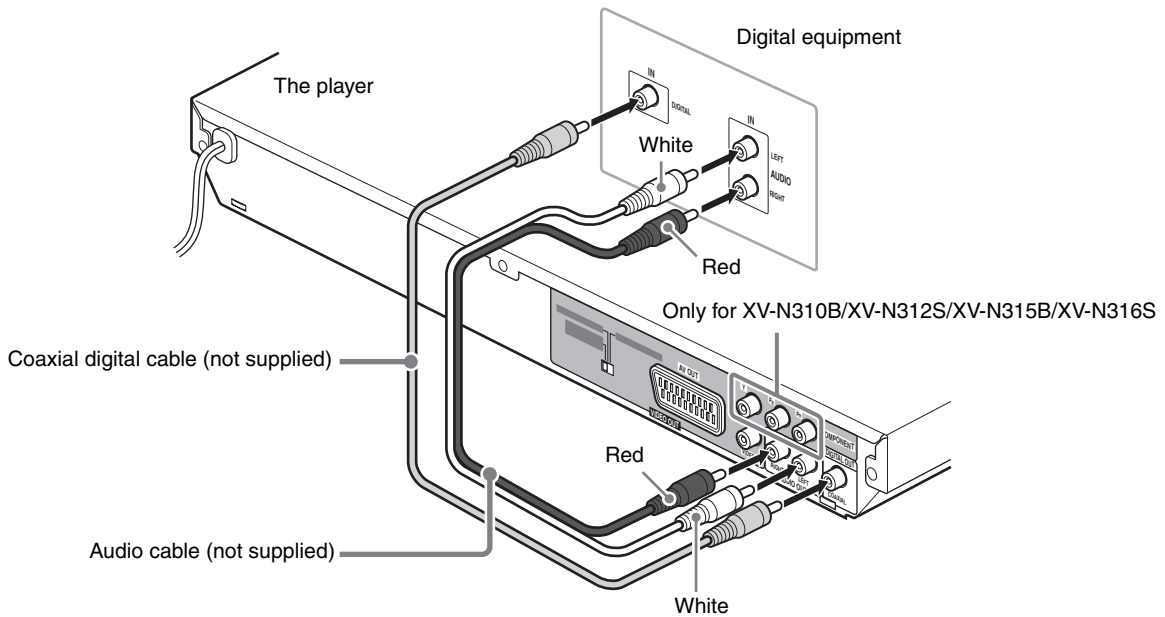

## Connecting the power cord

When all the audio/video connections have been made, connect the AC power plug to the wall outlet. Make sure that the plugs are inserted firmly.

The STANDBY/ON indicator lights in red.

### Warning

- Disconnect the power cord:
  - if you are not going to use the player for a long period of time.
  - before cleaning the player.
  - before moving the player.
- Do not:
  - connect or disconnect the power cord with wet hands.
  - pull the power cord when disconnecting it, as this may damage the cord and cause fire, electric shock, or other accidents.

### Caution

- Do not alter, twist or pull the power cord, or put anything heavy on it, which may cause fire, electric shock, or other accidents.
- If the cord is damaged, consult a dealer and have the power cord replaced with a new one.

## Using the remote control unit

### To install battery

- 1** While pushing the lock lever (①), pull out the battery holder (②).

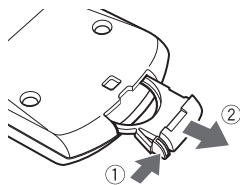

- 2** Place the supplied battery on the battery holder with the + side facing up.

Lithium coin battery  
(product number: CR2032)

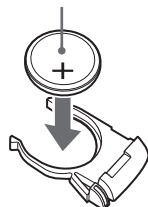

- 3** Insert the battery holder back into position.

## Precautions of the safe use of battery

- Store the battery in a place where children cannot reach.  
If a child accidentally swallows the battery, consult a doctor immediately.
- Do not recharge, short, disassemble or heat the battery or dispose of it in a fire.  
Doing any of these things may cause the battery to give off heat, crack, or start a fire.
- Do not leave the battery with other metallic materials.  
Doing this may cause the battery to give off heat, crack, or start a fire.
- When throwing away or saving the battery, wrap it in tape and insulate; otherwise, the battery may start to give off heat, crack, or start a fire.
- Do not poke the battery with tweezers or similar tools.  
Doing this may cause the battery to give off heat, crack, or start a fire.
- Dispose of batteries in the proper manner, according to federal, state, and local regulations.

### CAUTION

Danger of explosion if battery is incorrectly replaced.  
Replace only with the same or equivalent type.

## Remote sensor

Point the top of the remote control unit toward the remote sensor as directly as possible. If you operate it from a diagonal position, the operating range (approx. 5 m) may be shorter.

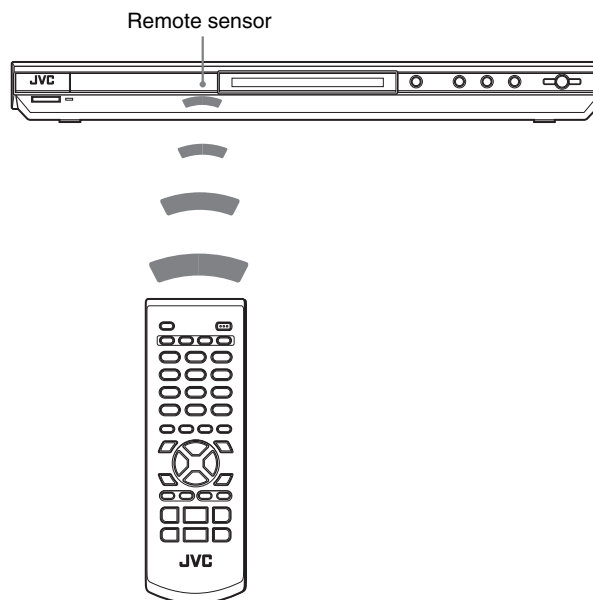



# Basic playback

- NOW READING (The player is reading the disc information.)
- REGION CODE ERROR! (The region code of the DVD VIDEO disc does not match the player. The disc cannot be played back.)
- CANNOT READ THIS DISC (The disc cannot be played back by the player.)
- OPEN (The disc tray is opening.)
- CLOSE (The disc tray is closing.)
- NO DISC (No disc is loaded.)

## NOTES

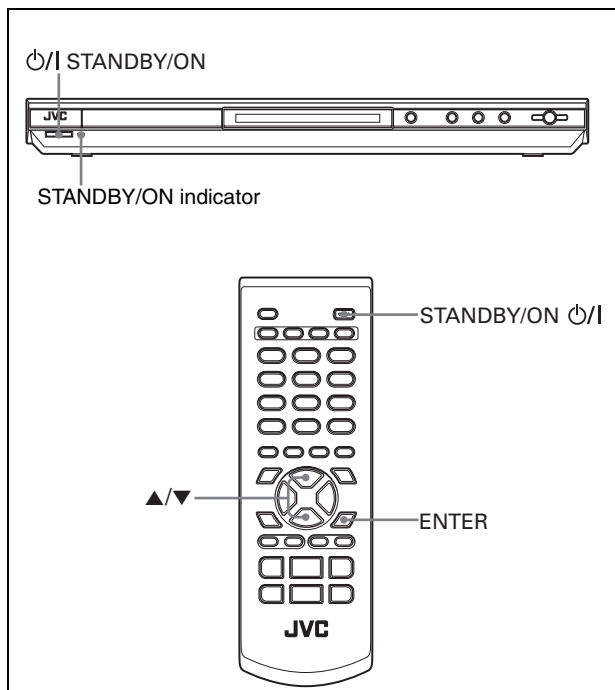
- Even if you turn off the player, the player is not disconnected from the AC power source as long as it is connected to the wall outlet. This state is called standby mode. In this state, the player consumes a very small amount of power.
- You can change the picture of the opening display. (See page 24.)



**About invalid operation icon**  
When you press a button, and if the player does not accept its operation,  appears on your TV screen. Operations are occasionally unacceptable even if  is not displayed. Note that some operations may not be accepted. For example, some discs may not allow rapid advance/reverse or slow-motion playback.

## Turning the player on and off

**Press STANDBY/ON  on the remote control unit or press  STANDBY/ON on the front panel.**

The STANDBY/ON indicator on the front panel, which lights in red during standby, goes off.

The opening display appears on the TV screen, and the following messages may appear at the bottom of the opening display.



Message area

## Initial setup

When you turn on the player for the first time after purchase, the following message appears on the TV screen.

EXECUTE DVD PLAYER SETUP? - BASIC PICTURE/AUDIO SETTING  
YES - PRESS ENTER NO - PRESS CANCEL

You can set the display language, TV monitor type and digital output before using the player, by following the procedure below.

### 1 Press ENTER.

The first page of the DVD PLAYER SET UP display appears. The pull-down menu of the [ON SCREEN LANGUAGE] is already open.

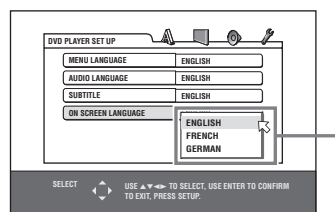

ON SCREEN LANGUAGE options

### 2 Press to select the desired language.

You can select the on-screen language for the preference displays, etc. from among ENGLISH, FRENCH and GERMAN.

### 3 Press ENTER.

The second page is shown, in which the pull-down menu of the [MONITOR TYPE] is already open.

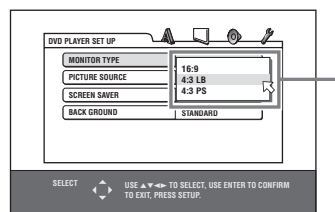

MONITOR TYPE options

### 4 Press to select the desired monitor type.

For a normal (conventional) TV, select [4:3 LB] or [4:3 PS].  
For a wide-screen TV, select [16:9]. (See page 26.)

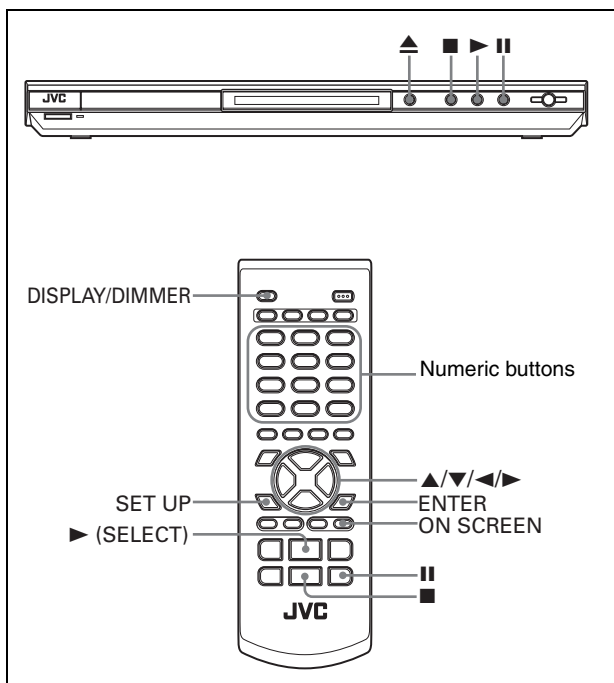

## 5 Press ENTER.

The third page is shown, in which the pull-down menu of the [DIGITAL AUDIO OUTPUT] is already open.

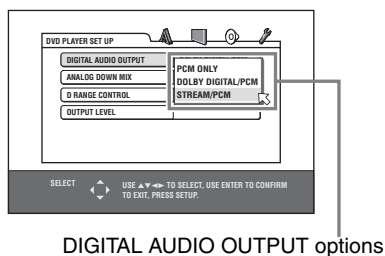

## 6 Press ▲/▼ to select a desired digital output signal type.

Set this item correctly when you connect the player to an external surround decoder or D/A converter. (If you do not connect the player to such a device, you do not have to set this item.)

- When connecting to other digital device, select [PCM ONLY].
- When connecting to a Dolby Digital decoder, select [DOLBY DIGITAL/PCM].
- When connecting to a DTS decoder, select [STREAM/PCM].

## 7 Press ENTER.

The TV screen returns to the opening display.

### To bring up the DVD PLAYER SET UP display later

Press SET UP for a few seconds until the DVD PLAYER SET UP display appears.

## Starting playback



- 1 Press ▲ on the player to open the disc tray.
- 2 Place a disc in the disc tray.

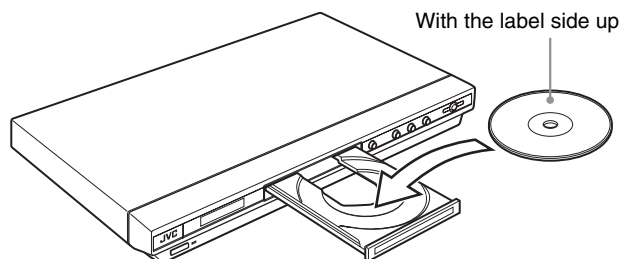

- To insert an 8-cm disc, place it in the inner recess.

- 3 Press ▲ on the player to close the disc tray.
- 4 Press ► on the unit or ► (SELECT) on the remote control unit.

The player starts playback from the beginning.

- Depending on the disc, playback starts when you close the disc tray.

### If a menu is shown on the TV screen

When inserting a DVD VIDEO, SVCD or Video CD disc, a menu may be shown on the TV screen. From the menu, you can select a desired item to be played back.

#### For DVD VIDEO

- 1 Press ▲/▼/◀/▶ to select a desired item.
  - 2 Press ENTER or ► (SELECT).
- The player starts playback of the selected item.

#### For SVCD/Video CD

Press the numeric buttons to select a desired item. The player starts playback of the selected item.

### NOTES

- Do not insert an unplayable disc. (See page 2.)
- When inserting a disc on the disc tray, be sure to position the disc inside the recess. Otherwise, the disc may be damaged when the disc tray is closed, or you may not be able to remove the disc from the player.

### To check the playback status

You can see the current selection number (the title/chapter number for DVD VIDEO or track number for SVCD/Video CD/Audio CD), time information (the track or chapter time while stopped, or elapsed track or chapter time during playback) and the transport status (stop, playback, pause, etc.) on the TV screen.

#### Press ON SCREEN.

Example: for DVD VIDEO

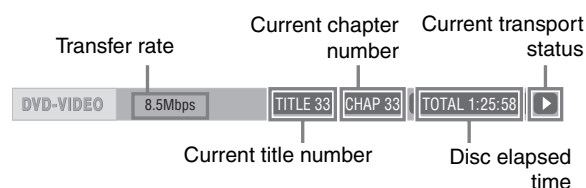

Note that pressing ON SCREEN again brings up the menu bar under the status bar, from which you can access various functions. See page 19 for details about the menu bar.

#### To turn off the status bar

Press ON SCREEN repeatedly until the status bar goes off.

#### To change the display window contents

##### Press DISPLAY/DIMMER.

Example: for DVD VIDEO

Each time you press DISPLAY/DIMMER, the total time display and the title/chapter number display appear alternately.

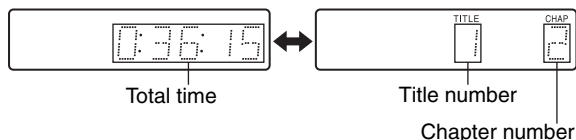

#### To stop playback completely

##### Press ■.

##### Hint

If you press ▲ during playback, the player stops playback and opens the disc tray.

#### To stop playback temporarily

##### Press II.

To resume playback, press ► (SELECT). (See the following item.)

#### About On-screen guide icons

You may see the following icons displayed over the picture. They have the following meanings.

- : Appears at the beginning of playback mode.
- : Appears at the beginning of pause mode.
- : Appears at the beginning of fast forward/backward playback with the current speed (see page 12).
- : Appears at the beginning of slow-motion playback with the current speed (see page 12).
- : Appears at the beginning of a scene recorded from multiple angles (see page 17).
- : Appears at the beginning of a scene recorded with multiple audio languages (see page 17).
- : Appears at the beginning of a scene recorded with multiple subtitle languages (see page 17).

You can change the setting so that the on-screen guide icons do not appear on the TV screen (see page 27).

#### About screen saver function

A television monitor may have an image burned into it if a static image is displayed for a long time. To prevent this, the player automatically activates the screen saver function if a static picture, such as an on-screen display or menu, is displayed while no button is pressed for over 5 minutes.

When the screen saver function is activated, the TV screen gets darker.

Pressing any buttons will release the screen saver function. You can set the screen saver function to ON or OFF (see page 26).

## Restarting playback after stopping (resuming playback)



The player resumes playback from the position you interrupted playback, as long as the disc you interrupted playback is still on the disc tray.

This is because the player's resume mode is set to ON when you purchased the player.

When the resume mode is set to ON, the player memorizes the position on a disc where you interrupted playback.

- When you press ■ to interrupt playback, the TV screen shows [RESUME STOP] and the [RESUME] indicator lights up in the display window.
- When you re-start playback, the TV screen shows [RESUME PLAY].

##### Hint

The memory of the interrupted position is not cleared even if you turn off the player.

##### To play back from the beginning

Press ■ while the disc is stopped.

The memory is cleared.

Then press ► (SELECT).

##### NOTES

- The player remembers the interrupted position even if you turn the power off.
- The memory is cleared if you open the disc tray.

#### Changing the resume mode

The player has three resume modes; ON, OFF and DISC RESUME.

- You can select the mode using the preference display (see page 27).

##### When the resume mode is "OFF"

Playback always starts from the beginning.

##### When the resume mode is "DISC RESUME"

The player memorizes interrupted positions for the last 30 discs played. Storing a new interrupted position will erase the interrupted position stored for the first disc.

The memory of the interrupted positions are not cleared even if you open the disc tray or turn off the player.

##### NOTES

- If you change the [RESUME] setting from [DISC RESUME] to [OFF] or [ON], you cannot resume playback of a disc whose "resuming" position is stored. However, when you again set [RESUME] to [DISC RESUME], you will then be able to resume playback of the disc.
- If you interrupt the playback of a disc for which an interrupted position has already been stored, the memory will be updated with the new interrupted position.
- For a double-sided DVD VIDEO disc, the player regards each side as a different disc. Therefore, to resume playback of such a disc, the disc must be inserted with the same side down.
- When the player memorizes an interrupted point for a disc, it also memorizes Audio, Subtitle and Angle settings.
- The player may not resume playback exactly from the interrupted point. In the case of an SVCD/Video CD disc with PBC function, the player may resume playback from a point slightly earlier or later than the point where playback was interrupted.

# Various kinds of playback

## To advance or reverse playback rapidly while monitoring



During playback, press **▶▶** or **◀◀** on the remote control unit.

**For DVD VIDEO:**

You can select from 1.5 times (2 times in the reverse direction), 5 times, 20 times and 60 times normal speed.

**For SVCD/Video CD/Audio CD:**

You can select from 2 times, 5 times and 20 times normal speed.

Pressing **▶** (SELECT) returns the player to normal playback.

**During playback, hold down ▶▶ or ◀◀.**

Playback is advanced or reversed at 5 times normal speed.

### NOTE

During rapid playback, the sound will be muted except when playing an Audio CD, and when playing a DVD VIDEO at 1.5 times normal speed.

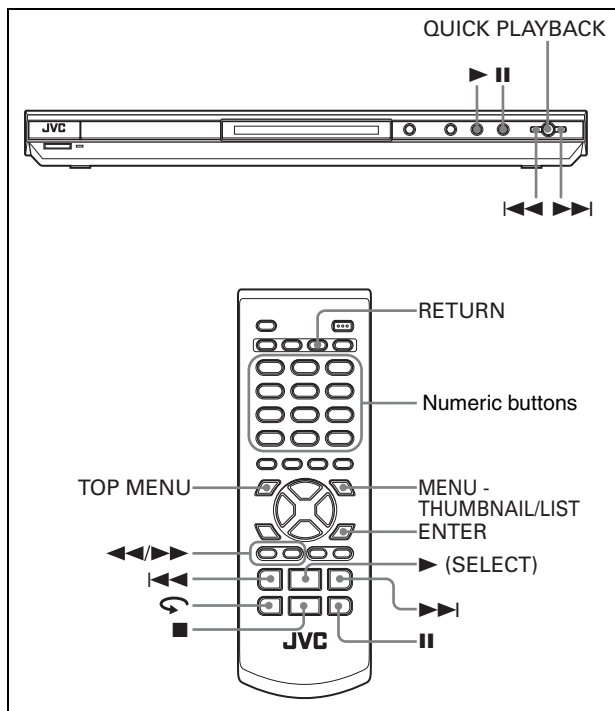

## To advance a still picture frame by frame



**While paused, press II.**

Each time you press **II**, the still picture advances to the next frame.

Pressing **▶** (SELECT) returns to normal playback.

## To play back in slow motion



You can select from 1/32 times, 1/16 times, 1/4 times and 1/2 times normal speed.

**During playback, press II, then press ▶▶ (to play forward slow motion), or ◀◀ (to play reverse slow motion, for DVD VIDEO disc only).**

Pressing **▶** (SELECT) returns to normal playback.

### NOTES

- During slow motion playback, the sound will be muted.
- Reverse slow motion playback is not possible for an SVCD and Video CD.

## To replay the previous scenes (One touch replay function)



**During DVD VIDEO playback, press ↺.**

The playback position moves back 10 seconds before the current position.

### NOTES

- This function works only within the same title, though it works between chapters.
- This function may not work with some DVD VIDEO discs.

## Playback at various speeds

### x1.5 Quick Playback with sound



**During playback, press QUICK PLAYBACK on the player.**

The disc is played back at about 1.5 times normal speed. The sound is not muted, and the subtitle does not go off.

**To return to the normal playback**

Press QUICK PLAYBACK again.

### NOTES

- x1.5 Quick Playback can also be achieved by pressing **▶▶** once. (See next section.)
- At the x1.5 Quick Playback mode, the digital sound is output in stereo linear PCM format.
- Depending on a disc, the sound may not be in tune, or the sound quality may alter during the x1.5 Quick Playback mode.
- If you press QUICK PLAYBACK while playing back a Video CD/SVCD, the disc is played back at 2 times normal speed, and the sound is muted.

## Locating the beginning of a scene or song



For DVD VIDEO: During playback, you can skip a chapter or title, depending on the disc configuration.

For SVCD/Video CD: During playback without PBC function, you can skip a track.

For Audio CD: During playback or while in stop mode, you can skip a track.

To skip forward, press ►►.

To skip backward, press ◀◀ twice.

## Using the numeric buttons

For DVD VIDEO/Audio CD: During playback or while in stop mode

For SVCD/Video CD: During playback without PBC function or while in stop mode

Press the numeric buttons to specify the number.

To select 5: press 5.

To select 23: press +10, +10, then 3.

To select 40: press +10, +10, +10, then 10.

The player starts playback from the beginning of the selection.

### NOTES

- Depending on the disc type and the player status, what is specified differs:

Player status	Disc type	What is specified
While stopped	DVD VIDEO	title
	SVCD/Video CD/Audio CD	track
During playback	DVD VIDEO	chapter
	SVCD/Video CD/Audio CD	track

- During DVD VIDEO playback, if a menu is shown on the TV screen, the numeric buttons may be used for selecting an item in the menu.

## Playing from a specific position

### Locating a desired scene from the DVD menu



DVD VIDEO discs generally have their own menus which show the disc contents. These menus contain various items such as titles of movies, names of songs, or artist information, and display them on the TV screen. You can locate a desired scene using the DVD menu.

- 1 While a DVD VIDEO disc is inserted, press TOP MENU or MENU - THUMBNAI/LIST.

The menu appears on the TV screen.

- 2 Press ▲/▼/◀/▶ to select a desired item, then press ENTER or ► (SELECT).

The player starts playback of the selected item.

### Hints

- Some DVD VIDEO discs may also have a different menu which appears when MENU - THUMBNAI/LIST is pressed.
- See the instructions of each DVD VIDEO disc for its particular menu.
- With some discs, you can select items by entering the corresponding number using the numeric buttons, which may cause the player to automatically start playback.

### NOTE

The MENU - THUMBNAI/LIST button does not work while stopped.

## Locating a desired scene from the menu of a SVCD/Video CD with PBC



Some SVCD/Video CD discs support the PBC function. PBC is an abbreviation of "Playback Control." Some SVCD/Video CD discs recorded with PBC have their own menus, such as a list of the songs of the disc. You can locate a specific scene by using the PBC menu.

- 1 In stop mode, press ► (SELECT) or TOP MENU.

A disc menu appears on the TV screen.

- 2 Press the numeric buttons to select the desired item.

To select 5: press 5.

To select 23: press +10, +10, then 3.

To select 40: press +10, +10, +10, then 10.

The player starts playback of the selected item. To return to the menu, press RETURN.

### Hint

If something like [NEXT] or [PREVIOUS] appears on the TV screen, pressing ►► advances to the next page, and pressing ◀◀ returns to the previous page.

### About PBC (Playback Control)

Some SVCD/Video CD discs support the PBC function. The PBC function allows you to enjoy menu-driven operation and high-resolution still images which have a resolution four times greater than moving pictures.

- To play a PBC-compatible SVCD/Video CD disc without activating the PBC function, press the numeric buttons instead of ► (SELECT) to start playback.
- To activate the PBC function again,
  - 1) press TOP MENU or MENU - THUMBNAI/LIST, or
  - 2) press ■ to stop playback, then press ► (SELECT).

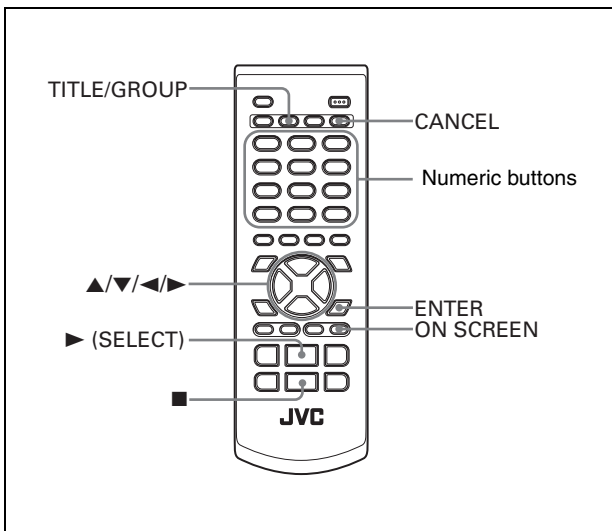

## Specifying a desired title

### DVD VIDEO

#### 1 During playback, press TITLE/GROUP.

[-] is shown in the title display area of the display window.

#### 2 Press the numeric buttons to specify a title to be played.

To select 5: press 5.

To select 23: press +10, +10, then 3.

To select 40: press +10, +10, +10, then 10.

The player starts playback from the specified title.

### NOTE

This function may not work with some DVD VIDEO discs.

## Locating a desired position in the current title or track (Time search)

### DVD VIDEO Super VCD Video CD Audio CD

You can play a disc from the desired position by specifying the time from the beginning of the current title (for DVD VIDEO) or the disc (for SVCD/Video CD/Audio CD).

For DVD VIDEO/Audio CD: During playback or while in stop mode

For SVCD/Video CD: In any condition except SVCD/Video CD playback with PBC

#### 1 Press ON SCREEN twice.

The menu bar appears on the TV screen.

#### 2 Press ◀▶ to move to [⏪▶], then press ENTER.

The pull-down menu for entering time appears.

#### Screen example for DVD VIDEO

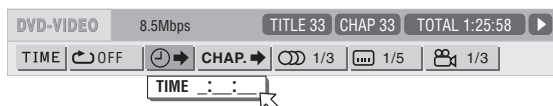

#### 3 Press the numeric buttons (0 to 9) to enter the desired time.

The specified time is displayed in the pull-down menu.

#### Example (for DVD VIDEO)

To play back from 2(H):34(M):00(S)

Press 2, 3, then 4.

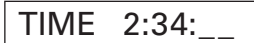

#### Example (for SVCD/Video CD/Audio CD)

To play back from 23(M):40(S)

Press 2, 3, then 4.

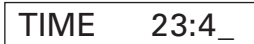

You do not have to press "0" to enter the trailing zeros (for the last two digits in the example above).

#### To correct a mistake

Press ◀ repeatedly to move back to the digit where you entered a wrong number, and reenter the correct one.

#### 4 Press ENTER.

The player starts playback from the specified time.

### To dismiss the menu bar

Press ON SCREEN.

### Hint

"10" and "+10" buttons are not used with this function.

### NOTES

- Some DVD VIDEO discs do not contain time information, and the time search function cannot be used.
- The time search function cannot be used during program and random playback modes.

## Changing the playback order

### To play back in a specific order (Program play)

### Super VCD Video CD Audio CD

By programming tracks, you can play up to 99 tracks in any order. You may program the same track more than once.

#### 1 In stop mode, press ON SCREEN twice.

The menu bar appears on the TV screen.

#### 2 Press ◀▶ to move to [⏪▶] to [PROG.].

Screen example for Audio CD

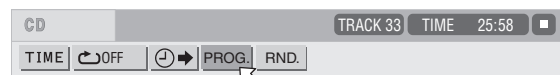

#### 3 Press ENTER.

The program table appears.

The [PROG] indicator lights up in the display window.



#### 4 Press the numeric buttons to specify tracks in the desired order.

To select 5: press 5.

To select 23: press +10, +10, then 3.

To select 40: press +10, +10, +10, then 10.

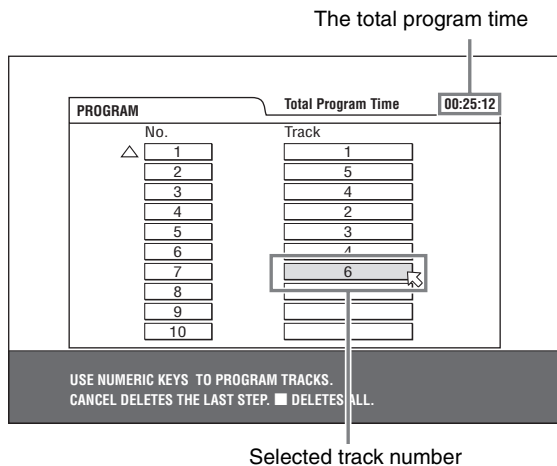

#### To correct the program

Press ▲/▼ to move to the track to be corrected, then press CANCEL. The track is erased and the subsequent programmed tracks move up.

Pressing ■ clears all the programmed tracks.

#### 5 Press ► (SELECT) to start program playback.

With an Audio CD disc, the program table remains on the TV screen during program playback. (Pressing ON SCREEN brings up the status bar.)

When all of the programmed tracks have finished playback, the player stops and the program table appears again.

Note that the program remains.

- During program playback, you cannot edit the program contents.

#### To check the program contents

During playback, press ■. Playback stops and the program table is shown.

When the player is playing back an Audio CD and the program table is not shown, you can bring up the table by carrying out steps 1 to 3.

During SVCD/Video CD playback, you can check the program contents via the menu bar.

#### To stop program playback

Press ■.

#### To clear the program

While stopped and the program table is shown, press ■.

#### To exit the program mode

After clearing the program, press ON SCREEN.

#### NOTE

When the disc tray is opened or the player is turned off, the program is cleared.

## To play back in random order (Random play)



### 1 In stop mode, press ON SCREEN twice.

The menu bar appears on the TV screen.

### 2 Press ◀▶ to move to RND.

Screen example for Audio CD

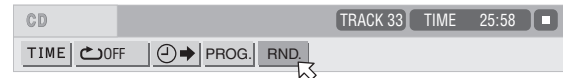

### 3 Press ENTER.

The player starts random playback.

With an SVCD/Video CD disc, the menu bar is automatically dismissed.

During random playback, the [RND] indicator lights up in the display window.

After playing all tracks of the disc, the player stops the disc and exits the random playback mode.

#### To stop and quit random playback

Press ■. The player stops playback and exits the random playback mode.

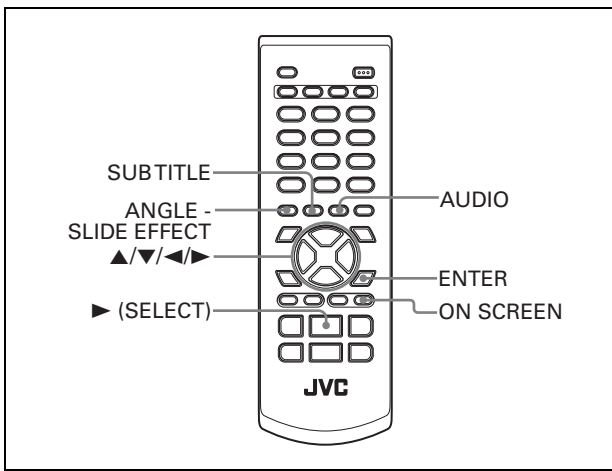

## Repeat playback

### To repeat the current selection or all tracks



For DVD VIDEO: During playback  
 For SVCD/Video CD/Audio CD: In any condition except SVCD/  
 Video CD playback with PBC

- 1 Press ON SCREEN twice.**  
 The menu bar appears on the TV screen.
- 2 Press ◀▶ to move [ ] to [ ] , then press ENTER.**  
 The pull-down menu for repeat mode selection appears.
- 3 Press ▲/▼ to select the desired repeat mode, then press ENTER.**  
**For DVD VIDEO**  
 CHAPTER: current chapter repeat  
 TITLE: current title repeat  
 A-B: see "To repeat a desired part (A-B repeat playback)" on this page.  
**For SVCD/Video CD/Audio CD**  
 TRACK: current track repeat  
 ALL: all track repeat  
 A-B: see "To repeat a desired part (A-B repeat playback)" on this page.
- 4 Press ▶ (SELECT).**

If you select the repeat mode while stopped, press ▶ (SELECT) to start repeat playback.

The [ ]/[ ] 1 indicator lights in the display window.

### To quit repeat playback

Select [OFF] at step 3 above.

#### Hint

When the program playback mode is active with an SVCD, Video CD or Audio CD, the repeat mode changes in the same manner.

Note, however, that in the [ ] mode the player repeats all the programmed tracks instead of all tracks on the disc.

#### NOTE

The repeat playback may not work with some discs, even if you select one of the repeat modes.

### To repeat a desired part (A-B repeat playback)



#### First make sure:

- The player is in playback mode except SVCD/Video CD playback with PBC.

- 1 While in playback mode, press ON SCREEN twice.**  
 The menu bar appears on the TV screen.
- 2 Press ◀▶ to move [ ] to [ ] , then press ENTER.**  
 The pull-down menu for repeat mode selection appears.
- 3 Press ▲/▼ to select [A-B].**
- 4 Press ENTER at the beginning of the part you want to repeat (point A).**  
 The pull down menu disappears.  
 The repeat icon shows [ ] A- .
- 5 Press ENTER at the end of the part you want to repeat (point B).**  
 The repeat icon shows [ ] A-B .  
 The player locates "A" and starts repeat playback between "A" and "B."  
 The [ ] indicator lights in the display window.

### To quit A-B repeat playback

Press ◀▶ to move [ ] to [ ] A-B , and press ENTER twice. The A-B repeat mode turns off, then normal playback continues.

#### NOTE

The A and B points must be set in the same title/track.

# Changing the language, sound and scene angle

## To select the subtitle language (SUBTITLE)



Some DVD VIDEO and SVCD discs contain more than one subtitle language. You can choose a desired one from them.

### Hint

At the beginning of a DVD VIDEO disc where subtitles are recorded, appears on the TV screen (except when the [ON SCREEN GUIDE] preference is set to [OFF]).

### 1 During playback, press SUBTITLE.

The subtitle selection window appears on the TV screen.

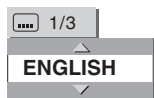

### 2 Press ▲/▼ or SUBTITLE to select the subtitle.

Each time you press ▲/▼ or SUBTITLE, the subtitle language changes.

### 3 Press ENTER.

Subtitles are displayed in the selected language. The subtitle selection window is dismissed.

### NOTES

- An SVCD disc can have up to four subtitles. Pressing ▲/▼ cycles through those channels regardless of whether the subtitles are recorded or not.
- The subtitle selection window will automatically disappear if you do not change the subtitle for several seconds.
- For DVD VIDEO, the selected language may be abbreviated on the TV screen. See “Appendix B: Table of languages and their abbreviations” on page 33.

## To change the audio language or sound (AUDIO)



The audio selection setting allows you to change the audio language of a movie, or to listen to karaoke with or without the vocal.

### Hint

At the beginning of the part where multiple audio tracks are recorded, appears on the TV screen (except when the [ON SCREEN GUIDE] preference is set to [OFF]).

### 1 During playback, press AUDIO.

The audio selection window appears on the TV screen.

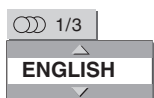

### 2 Press ▲/▼ or AUDIO to select the desired audio.

Each time you press ▲/▼ or AUDIO, the audio changes.

For DVD VIDEO (example)



For SVCD

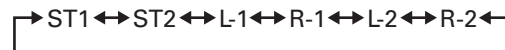

For Video CD



### 3 Press ENTER.

You can hear the selected audio. The audio selection window is dismissed.

### NOTES

- The audio selection window will automatically disappear if you do not change the audio for several seconds.
- For DVD VIDEO, the selected language may be abbreviated on the TV screen. See “Appendix B: Table of languages and their abbreviations” on page 33.

## To select a scene angle of DVD VIDEO (ANGLE)



You can enjoy a variety of scene angles if the DVD VIDEO disc contains “multi-angle” parts, where multiple cameras were used to shoot the same scene from different angles.

### Hint

At the beginning of a “multi-angle” part, appears on the TV screen (except when the [ON SCREEN GUIDE] preference is set to [OFF]).

### 1 During playback, press ANGLE - SLIDE EFFECT.

The angle selection window appears on the TV screen.

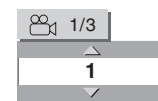

### 2 Press ▲/▼ or ANGLE - SLIDE EFFECT to select the desired angle.

Each time you press ▲/▼ or ANGLE - SLIDE EFFECT, the angle changes.

### 3 Press ENTER.

You can see the picture from the selected angle. The angle selection window is dismissed.

### NOTES

- The angle selection window will automatically disappear if you do not change the angle for several seconds.
- This function may not work with some DVD VIDEO discs.

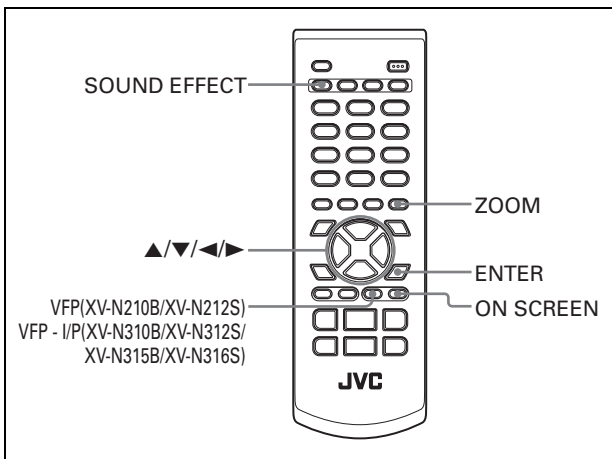

## Special picture and sound effects

### To zoom in pictures



**1** During playback or while paused, press **ZOOM**.

ZOOM x 1.5

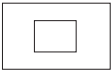

Pressing **ZOOM** causes the player to zoom in on the image. At the top left of the screen, the information for the current magnification appears for about 5 seconds. Each time you press **ZOOM**, the magnification rate is changed (1.5, 2 and 4 times).

When a picture of a DVD VIDEO disc is viewed on a normal TV screen (4:3, Letter Box), black bars may appear at the top and bottom of the screen.

**2** Press **▲/▼/◀/▶** to move the zoomed position.

### To return to the normal playback

Select the normal size by pressing **ZOOM** repeatedly.

#### NOTES

- While zoomed, the picture may look coarse.
- This function may not work with some DVD VIDEO discs.

### To adjust the picture character (VFP)



The VFP (Video Fine Processor) function allows you to adjust the picture character according to the type of programming, picture tone or personal preferences.

**1** During playback, press **VFP** (for **XV-N210B/XV-N212S**) or **VFP - I/P** (for **XV-N310B/XV-N312S/XV-N315B/XV-N316S**).

The VFP mode selection window appears on the TV screen.

**2** Press **◀/▶** to select the desired preset.

Each time you press the button, the VFP mode changes as follows. Set the video type most suitable to the current program or the room conditions.

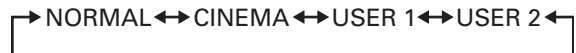

Selected preset

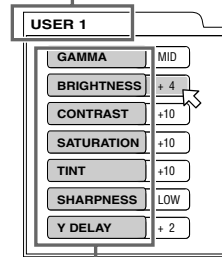

Parameter

[NORMAL]: for watching TV in a general room.

[CINEMA]: for watching a movie software in a room with suppressed light.

[USER 1] [USER 2]: you can adjust parameters that affect the picture character and store the settings as a user preset. See the next step.

**3** To define a user setting, press **▲/▼** to select a parameter to be edited from the following.

- **GAMMA**  
Adjust this if the neutral color is bright or dark. The brightness of dark and bright portion is maintained. Available range: LOW/MID/HIGH.
- **BRIGHTNESS**  
Adjust this if the picture is bright or dark on the whole. Available range: -16 (darkest) to +16 (brightest).
- **CONTRAST**  
Adjust this if the far and near position is unnatural. Available range: -12 to +12.
- **SATURATION**  
Adjust this if the picture is whitish or blackish. Available range: -16 (blackest) to +16 (whitest).
- **TINT**  
Adjust this if the appearance of flesh tone is unnatural. Available range: -16 to +16.
- **SHARPNESS**  
Adjust this if the picture is indistinct. Available range: LOW/HIGH.
- **Y DELAY**  
Adjust this if the picture looks separately/overlapped. Available range: -2 to +2.

**4** Press **ENTER**.

A window for setting parameters appears.



Selected parameter

**5** Press **▲/▼** to adjust the level of the parameter.

The higher value enhances the effect for each item other than [GAMMA] and [SHARPNESS].

**6** Press **ENTER**.

Repeat steps 3 to 6 if you want to set other parameters.

## To dismiss the VFP mode selection window

Press VFP (for XV-N210B/XV-N212S) or VFP - I/P (for XV-N310B/XV-N312S/XV-N315B/XV-N316S).

### NOTES

- The window for VFP mode selection and parameter setting disappear if no operation is made for about 10 seconds.
- The VFP function is not available while the picture is zoomed.

## To change sound field (SOUND EFFECT)



Using the Sound Effect function, you can change the sound field only for analog audio output.

### 1 During playback, press SOUND EFFECT.

The Sound Effect indication appears on the TV screen.

### 2 Press SOUND EFFECT to select the desired mode.

Each time you press the button, the Sound Effect mode changes as follows:

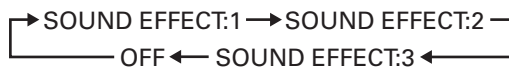

- As the value becomes bigger, the Sound Effect works stronger.

## To deactivate the Sound Effect

Press SOUND EFFECT repeatedly until [OFF] appears on the TV screen.

### NOTE

The Sound Effect indication disappears if no operation is made for a few seconds.

## Menu bar functions

### To bring up the menu bar

#### 1 When a disc is inserted, press ON SCREEN.

A status bar for the type of disc inserted will appear on the TV screen.

See page 10 for details about the status bar.

#### 2 Press ON SCREEN again.

A menu bar for the type of disc inserted will appear under the status bar.

(for DVD VIDEO)



(for SVCD)

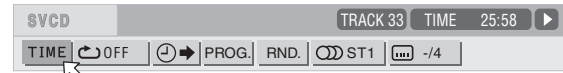

(for Video CD)

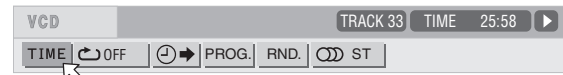

(for Audio CD)

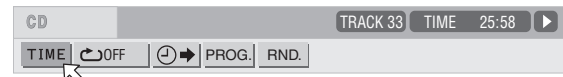

### To dismiss the menu bar and status bar

Press ON SCREEN.

## Basic operation procedure

### 1 Press ◀▶ to select the icon you want to work with.

The selected icon is pointed by ↖.

### 2 Press ENTER.

With many icons, an appropriate pull-down window appears, however, there are some exceptions.

### NOTES

- A mark or text on the menu icon for the function or mode currently selected is shown in green.
- Some functions are not available during playback. (You cannot move ↖ to the associated icon when it is not available.)

## Menu bar functions for DVD VIDEO

### Time mode selection

During playback, selects the time mode shown in the display window and in the status bar.

Press ENTER to select the time mode from the following.

- TOTAL: Current title elapsed time
- T.REM: Current title remaining time
- TIME: Current chapter elapsed time
- REM: Current chapter remaining time

### Repeat mode (See also page 16)

Selects the repeat mode during playback.

1. Open the pull-down window.
2. Press ▲/▼ to select the repeat mode from the following.
  - CHAPTER: Current chapter repeat
  - TITLE: Current title repeat
  - A-B: A-B repeat
  - OFF: Repeat mode deactivated
3. Press ENTER to make the selected repeat function active.

### Time search (See also page 14)

Specifies a time from the beginning of the current title as the point from which to begin playback.

### Chapter search

During playback, specifies a desired chapter to be played back from.

1. Open the pull-down window.
2. Press numeric buttons (0 to 9) to enter a desired chapter number. (For example, to specify "10," press 1, then 0.)
3. Press ENTER to begin playback from the specified chapter.

### Audio selection (See also page 17)

During playback, selects the audio language or sound track.

1. Open the pull-down window.
2. Press ▲/▼ to select a desired audio language or sound track.
3. Press ENTER to begin playback with the selected audio.

### Subtitle selection (See also page 17)

During playback, selects the subtitle language.

1. Open the pull-down window.
2. Press ▲/▼ to select a desired subtitle language.
3. Press ENTER to begin playback with the selected subtitle.

### Angle selection (See also page 17)

During playback, selects a desired scene angle in a multi-angle part.

1. Open the pull-down window.
2. Press ▲/▼ to select a scene angle.
3. Press ENTER to begin playback with the selected scene angle.

## Menu bar functions for SVCD/Video CD/ Audio CD

### Time mode selection

Selects the time mode shown in the display window and in the status bar.

Press ENTER to select the time mode from the following.

- TIME: Current track elapsed time
- REM: Current track remaining time (while in stop mode, current track total time)
- TOTAL: Disc elapsed time
- T.REM: Disc remaining time (while in stop mode, disc total time)

### Repeat mode (See also page 16)

Selects the repeat mode.

1. Open the pull-down window.
2. Press ▲/▼ to select the repeat mode from the following.
  - TRACK: Current track repeat
  - ALL: All track repeat
  - A-B: A-B repeat
  - OFF: Repeat mode deactivated
3. Press ENTER to make the selected repeat function active.

### Time search (See also page 14)

Specifies a time from the beginning of the disc as the point from which to begin playback.

### Program playback (See also page 14)

While stopped, specifies the playback order of tracks.

### Random playback (See also page 15)

While stopped, activates random playback.

### Audio selection (See also page 17)

During SVCD/Video CD playback, selects the audio channel(s).

1. Open the pull-down window.
2. Press ▲/▼ to select a desired audio channel(s).
3. Press ENTER to play back with the selected audio channel(s).

### Subtitle selection (See also page 17)

During SVCD playback, selects the subtitle.

1. Open the pull-down window.
2. Press ▲/▼ to select a desired subtitle.
3. Press ENTER to begin playback with the selected subtitle.

# Audio/Video files playback

## Outline

The player can play back MP3/JPEG/MPEG-4 (simple profile/asf file) files on either a personally recorded CD-R/RW disc, or a commercially available CD.

You can select and play back files using the Control display on the TV screen.

- The player may be unable to play back a disc due to the characteristics or recording conditions.

## Precautions

### About files and folders (groups) on the disc

- Files are sometimes grouped into folders by genre, album, etc. In this manual, “group” is also referred to as “folder.”
- A folder which has one or more files is regarded as a group.
- The player can detect and play back the groups which are located up to the fifth layer.
- The files in the Control display are arranged by the alphabetical order of extensions as follows: “.asf,” “.jpeg” and “.mp3.”
- Time required for reading the disc contents may vary for different discs, depending on the numbers of folders (groups) and files recorded, etc.
- Files which do not belong to any folder are grouped into “group 1.”
- The player recognizes up to 999 files per group, and up to 250 groups per disc. Files other than MP3/JPEG/MPEG-4 files also count in the 999 total.

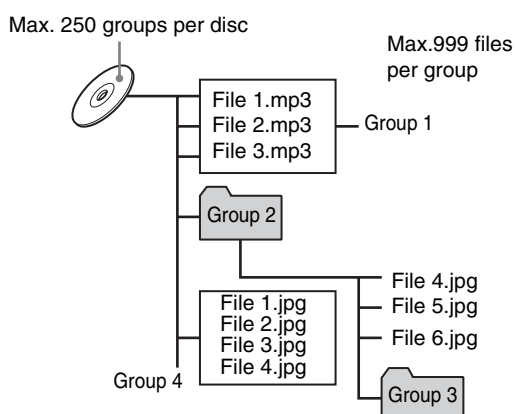

### Notes for making your own disc using a CD-R/CD-RW disc

- Use “ISO 9660” as the disc format.
- The player does not support “packet writing (UDF file)” discs.
- The player supports discs recorded with up to five multiple sessions.
- Some discs may not play due to disc characteristics or recording conditions.

### Notes for making files/groups

- If a file name includes even one 2-byte character, the player may not show the file name correctly.
- The player supports up to 12 characters as the group/file names.
- The player can only recognize files with one of the following extensions, which can be in any combination of upper and lower case:
  - For MP3 files, “.MP3,” “.mp3.”
  - For JPEG files, “.JPG,” “.JPEG,” “.jpg,” “.jpeg.”
  - For MPEG-4 files, “.ASF,” “.asf.”
- **For MP3 files:**
  - It is recommended that you record your material at a 44.1 kHz sampling rate, using the 128 kbps data transfer rate.
  - ID 3 Tag is not available.
  - MP3i and MP3 Pro are not available.
- **For JPEG files:**
  - We recommend you to record your material at a 640 × 480 pixel resolution.
  - This player supports the baseline JPEG and progressive JPEG formats.
  - The player does not support a baseline-formatted picture of more than 5120 × 3413 pixels. Make sure that the pictures pixel size is 5120 × 3413 pixels or less.
  - The player cannot play back a progressive JPEG file of more than 2048 × 1536 pixels.
  - Depending on the TV used, the border area of the picture may be cut off.
- **For MPEG-4 files:**
  - This player supports the type of simple profile and asf as MPEG-4 files.
  - To play back MPEG-4 files created on a digital still/video camera on this player, record them on a CD-R/RW disc and play it back.
  - The size of the playback screen will be the same size as it is recorded.
  - Some recorded files may not be able to be played back depending on file characteristics, kind of digital still/video cameras, or recording conditions.
  - Some MPEG-4 files created on a personal computer may not be played back.
  - For additional information concerning MPEG-4 files playback on the XV-N315B/XV-N316S, refer to the separate sheet.

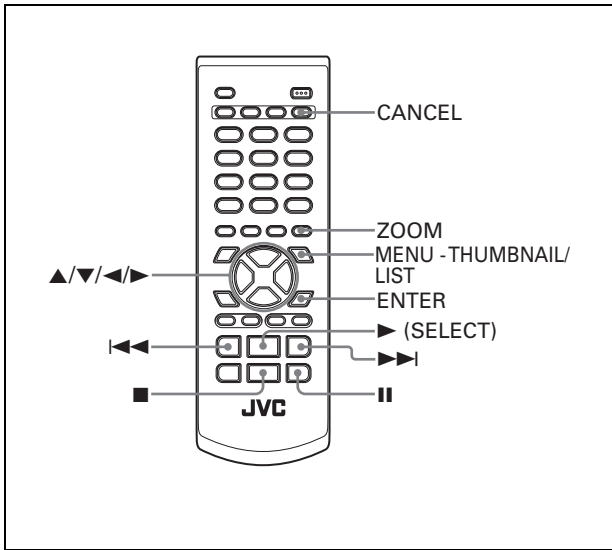

## To pause playback

Press **II**.  
Pressing **▶** (SELECT) resumes normal playback.

## To zoom in a picture

Press **ZOOM**.

- Each time you press **ZOOM**, the magnification rate is changed — 1.5 times, 2 times and 4 times for JPEG file; 2 times and 4 times for MPEG-4 file. (4-time magnification for JPEG file is possible only when its resolution is 640 x 480 pixels or more.)
- The four-time magnification may not work for some MPEG-4 files according to their resolutions.
- Pressing **▲/▼/◀/▶** moves the zoomed position during playback of JPEG file. [PAN UP], [PAN DOWN], [PAN LEFT] and [PAN RIGHT] are shown respectively on the TV screen.

To cancel the zoom function, select the normal size by pressing **ZOOM** repeatedly.

## To rotate/reflect a still picture

While a still picture is played back:

- Pressing **▶** rotates the picture by 90° clockwise.
- Pressing **◀** rotates the picture by 90° counterclockwise.
- Pressing **▲** reflects the picture vertically.
- Pressing **▼** reflects the picture horizontally.
- [ROTATING] is shown on the TV screen.

## To stop playback

Press **■**.  
The Control display appears on the TV.

### NOTES

- It may take time to show the Control display due to the layer configuration of the files and groups.
- The elapsed time may be incorrectly indicated on the display window due to the recording condition of the file.
- In the normal playback mode, playback stops when all the files in a group are played.
- The playback information appears on the TV as follows:
  - [JPEG DATA ERROR] means that this player cannot play back the file.
  - [JPEG DATA CORRUPTED] means that the file has error but the player can play it back.
  - [NEXT] means the player skips to the next file.
  - [PREVIOUS] means the player skips to the previous file.
  - [SELECT] means the file is selected on the thumbnail screen.

## Basic operations

When you insert a disc with groups and files, the Control display that shows the contents of the disc automatically appears on the TV screen.

You can specify and play back the desired group/file from the Control display using the following procedure.

### 1 Make sure that the cursor bar is in the left (group) column on the Control display.

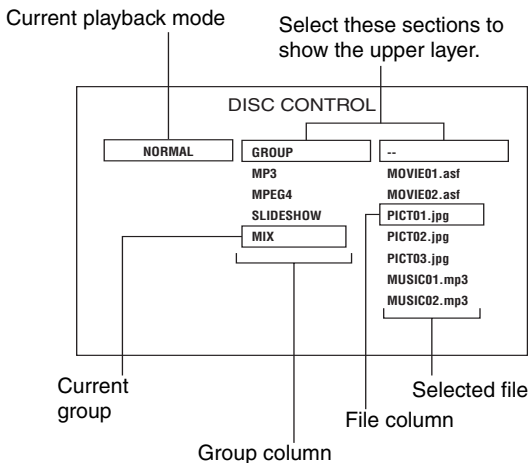

- If it is in the right column, press **◀** to move it to the left column.
- ### 2 Press **▲/▼** to move the bar to a desired group, then press **ENTER** or **▶**.
- In the right column, files in the selected group are shown.

### 3 Press **▲/▼** to select the desired file, then press **ENTER**.

- The selected file is played back.
- When you press **▶** (SELECT), the continuous playback starts from the selected file.
  - You can change the files on the list by pressing **◀◀/▶▶**.

### NOTES

- Files can also be selected by pressing the numeric buttons.
- If no operation is made for more than 5 minutes while the Control display is shown, the screen saver function will be activated and the Control display disappears.

## Direct selection for JPEG files

You can select a particular JPEG file from the thumbnail screen.

### 1 Press and hold **MENU - THUMBNAI/LIST** while a JPEG file is selected on the Control display.

The thumbnail screen appears on the TV screen. Up to nine thumbnails from the selected file at a time can be displayed on the screen.

- When selecting a group on the Control display, the thumbnail screen does not appear.

### 2 Press **▲/▼/◀/▶** to select the desired picture on the thumbnail screen, then press **ENTER**.

The selected picture is played back.

- You can change the thumbnails by pressing **◀◀/▶▶**. All the JPEG files in the single group are displayed every nine thumbnails.



---

## Changing the playback order

---

### Playing back in random order (Random play)

- 1** While stopped, press ◀ to select the current playback mode (such as [NORMAL]).
- 2** Press ENTER repeatedly to select [RANDOM].
- 3** Press ▶ to move the cursor bar to the file column.
- 4** Press ▶ (SELECT).

Playback stops when all the files in the selected group are played back in random order.

#### To stop random playback

Press ■.  
Note that the random playback mode remains active.

#### To quit random playback

Select [NORMAL] in step 2 above.

---

### To play back in a specific order (Program play)

- 1** In stop mode, press ◀ to select the current playback mode (such as [NORMAL]).
- 2** Press ENTER repeatedly to select [PROGRAM].
- 3** Press ▶ to move the bar to the group column, and press ▲/▼ to select the desired group.
- 4** Press ENTER.
- 5** Press ▲/▼ to select the desired file.
- 6** Press ENTER.  
The selected file is added to the program list under [PROGRAM].
- 7** Repeat steps 3 to 5 to program other files.  
**To erase the last programmed file**  
Press ◀ to move the cursor bar to the programmed files column, then press CANCEL. The last programmed file is erased.
- 8** Press ▶ (SELECT) to start program playback.

#### To stop program playback

Press ■.  
Note that the program playback mode remains active.

#### To quit program playback mode

Select [NORMAL] in step 2 above.

#### NOTE

You cannot add a file between the files already programmed.

---

## Repeat playback

- 1** While stopped, press ◀ to select the current playback mode (such as [NORMAL]).
- 2** Press ENTER repeatedly to select the desired repeat mode.  
REPEAT 1: Repeats the current file.  
REPEAT GROUP: Repeats all files in the current group.  
REPEAT ALL: Repeats all files on the disc.
- 3** Press ▶ to move the cursor bar to the file column.
- 4** Press ▶ (SELECT).

#### To stop repeat playback

Press ■.  
Note that the repeat mode remains active.

#### To quit repeat playback

Select [NORMAL] in step 2 above.

---

## Slide show playback

You can display files (still pictures) one after another automatically.

**Press ▶ (SELECT) while a JPEG file is selected on the Control display.**

- The slide show starts from the beginning of the disc.
- The display time varies in size of each file.

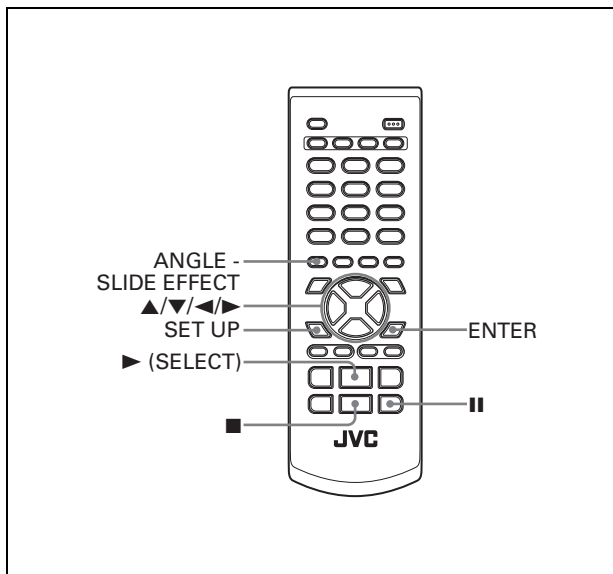

### To change the effect on displaying images

You can select the effect of slide show.

- During the slide show playback of progressive JPEG files, you cannot change the effect.

Press and hold ANGLE - SLIDE EFFECT.

[SLIDE EFFECT MODE:] and the current mode appear on the TV screen.

- Each time you press and hold the button, the effect changes as follows:

Mode	Type of wipe
1	Scroll wipe 1: The next image slides in from top to bottom.
2	Scroll wipe 2: The next image slides in from bottom to top.
3	Shutter wipe 1: The next image slides in vertically from both sides to center.
4	Shutter wipe 2: The next image slides in vertically from center to both sides.
5	Blind wipe 1: The next image slides in vertically through 4 slits.
6	Slide wipe 1: The next image slides in from left to right.
7	Slide wipe 2: The next image slides in from right to left.
8	Door wipe 1: The next image slides in horizontally from both sides to center.
9	Door wipe 2: The next image slides in horizontally from center to both sides.
10	Window wipe: The next image slides in from each side to center.
11	Blind wipe 2: The next image slides in horizontally through 4 slits.
RAND	The player selects and applies the effect to each image randomly.
NONE	Cancels the effect.

### To stop slide show playback in the middle

Press ■.

The TV screen returns to the Control display.

- Pressing ► (SELECT) resumes slide show playback from the last picture displayed.

### To keep showing the current picture

Press ■.

- Pressing ► (SELECT) resumes slide show playback.

#### NOTE

During slide show playback, you cannot use the thumbnail function.

## Changing the picture of the opening display

You can change and set the opening display to your favorite image. See page 27.

### 1 Play back a JPEG file to be displayed as the opening display.

When the slide show is started, press ■ to pause the slide show.

### 2 Press SET UP and ◀▶ to show PICTURE menu of the on-screen menu.

### 3 Press ▲/▼ to select [BACKGROUND], then press ENTER.

### 4 Press ▲/▼ to select [SAVE AS BACKGROUND], then press ENTER.

### 5 Press ▲/▼ to select [YES], then press ENTER.

The player starts reading the selected JPEG file, and the opening screen is changed after reading the file.

- The previous picture of the opening display is overwritten by the newly saved file.

### To dismiss the menu screen

Press SET UP.

### To resume the JVC's opening screen

Select [STANDARD] in step 4.

# Changing the initial settings

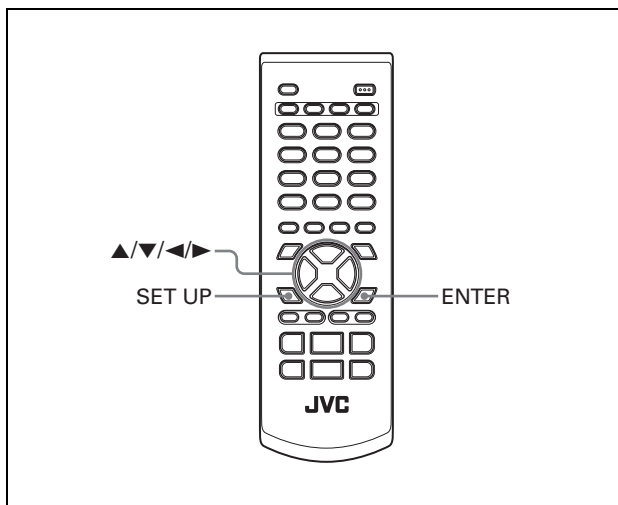

## Selecting preferences

This section refers to the settings which are already made when you purchase the player. Read this section when you want to connect this player to a wide-vision TV set, or when you want to otherwise change the settings according to your preferences and viewing environment.

## About the Preference display

The Preference display consists of the LANGUAGE, PICTURE, AUDIO and OTHERS setting displays, each having setting items.

### LANGUAGE

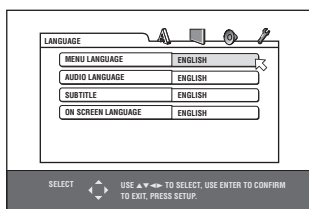

### PICTURE

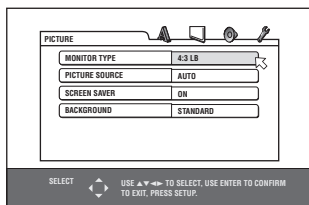

### AUDIO

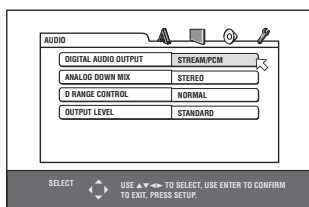

## OTHERS

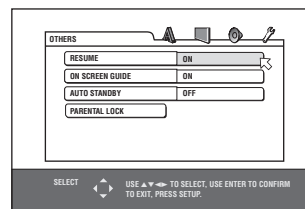

For the XV-N315B/XV-N316S, the actual OTHERS menu differs from the above illustration. Refer to the separate sheet for the correct information.

## How to set preferences

### 1 Press SET UP.

One of the preference on-screen displays appears on the TV screen. You can see four icons at the top right of the on-screen display for the settings.

: LANGUAGE menu

: PICTURE menu

: AUDIO menu

: OTHERS menu

### 2 Press to select the appropriate icon.

The appropriate display appears on the TV screen.

### 3 Press / to move to select the item you want to edit.

The color of the selected item changes.

### 4 Press ENTER.

A pull-down menu appears over the selected item.

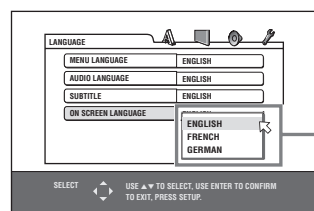

Selected item

### 5 Press / to select from the options then press ENTER.

The selected option is set.

- For details about each setting, see the following.

## To dismiss a preference display

Press SET UP.

### NOTES

- While a disc containing MP3/MPEG-4 files is inserted, you cannot bring up any preference display.
- When a preference display is shown on a wide TV screen, the upper and lower parts of the preference display sometimes may be cut off. If this happens, adjust the picture size control of the TV.

## LANGUAGE menu

### MENU LANGUAGE

You can select the default menu language to be displayed if it is contained on a DVD VIDEO disc.

#### Setting options

**ENGLISH, SPANISH, FRENCH, CHINESE, GERMAN, ITALIAN, JAPANESE, language code from AA to ZU**

- If the disc does not have a menu in the selected language, the disc's default language will be used.
- For details about language codes, see "Appendix B: Table of languages and their abbreviations" on page 33.
- You cannot change the setting during playback.

### AUDIO LANGUAGE

You can select the default audio language to be played if it is contained on a DVD VIDEO disc.

#### Setting options

**ENGLISH, SPANISH, FRENCH, CHINESE, GERMAN, ITALIAN, JAPANESE, language code from AA to ZU**

- If the disc does not have the selected language, the disc's default language will be used.
- For details about language codes, see "Appendix B: Table of languages and their abbreviations" on page 33.
- You cannot change the setting during playback.

### SUBTITLE

You can select the default subtitle language to be displayed if it is contained on a DVD VIDEO disc.

#### Setting options

**OFF, ENGLISH, SPANISH, FRENCH, CHINESE, GERMAN, ITALIAN, JAPANESE, language code from AA to ZU**

- If the disc does not have a subtitle in the selected language, the disc's default language will be used.
- For details about language codes, see "Appendix B: Table of languages and their abbreviations" on page 33.
- You cannot change the setting during playback.

### ON SCREEN LANGUAGE

You can select the on-screen display language of the player.

#### Setting options

**ENGLISH, FRENCH, GERMAN**

- Some on-screen messages are shown in English regardless of the setting.

## PICTURE menu

### MONITOR TYPE

You can select the monitor type to match your TV when you play back DVD VIDEO discs recorded for wide-screen televisions.

#### Setting options

**16:9, 4:3 LB, 4:3 PS**

**[16:9] (Wide television screen):** select when you connect the player to a wide-screen (16:9) TV.

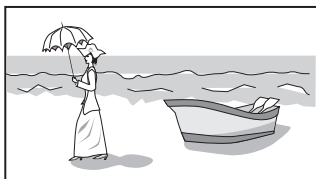

**[4:3 LB] (Letter Box conversion):** select when you connect the player to a normal (4:3) TV.

When playing back a DVD VIDEO disc recorded in wide picture format, the picture is shown with black bars at the top and bottom.



**[4:3 PS] (Pan Scan conversion):** select when you connect the player to a normal (4:3) TV.

When playing back a DVD VIDEO disc recorded in wide picture format, the picture is zoomed to fill the screen vertically, and the left and right sides of the image are chopped off.

Note, however, that the picture will be shown in the 4:3 LB mode even if you select the 4:3 PS mode depending on the disc.

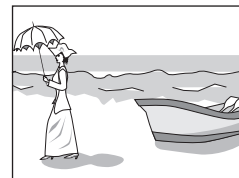

### PICTURE SOURCE

This mode selects whether the content on the disc is processed by field (video source) or by frame (film source). You can obtain optimal picture quality according to the source type to be played back by selecting an appropriate option.

#### Setting options

**AUTO, FILM, VIDEO(NORMAL), VIDEO(ACTIVE)**

**[AUTO]:** select when playing back a disc containing both video and film source materials.

The player recognizes the picture type (film or video source) of the current disc according to the disc information. Normally, select this option.

**[FILM]:** select when playing back a film source disc.

**[VIDEO(NORMAL)]:** select when playing back a video source disc with relatively a few movements.

**[VIDEO(ACTIVE)]:** select when playing back a video source disc with relatively a lot of movements.

### SCREEN SAVER

You can set the screen saver function to ON or OFF. (See page 11.)

#### Setting options

**ON, OFF**

## BACKGROUND

You can change and set the opening display to your favorite image using this menu.

### Setting options

#### STANDARD, USER, SAVE AS BACKGROUND

**[STANDARD]:** select when you use the JVC original image as the opening display (initial setting).

**[USER]:** select when you use your favorite image as the opening display. This item will be taken effect after you register a new image in the next item.

**[SAVE AS BACKGROUND]:** select when you register a new image. To register a new image, see “Changing the picture of the opening display” on page 24.

## AUDIO menu

### DIGITAL AUDIO OUTPUT

To connect the player's digital output to an external device equipped with a digital input, this item must be set correctly. See “Appendix C: Digital output signal chart” on page 34 for details about the relation between the setting and output signals.

#### Setting options

##### PCM ONLY, DOLBY DIGITAL/PCM, STREAM/PCM

**[PCM ONLY]:** select when you connect the DIGITAL OUT jack of the player to the linear PCM digital input of other audio equipment.

**[DOLBY DIGITAL/PCM]:** select when you connect the digital input of a Dolby Digital decoder or an amplifier with a built-in Dolby Digital decoder.

When this option is selected, playing back a disc recorded by the MPEG Multichannel format outputs a linear PCM digital signal.

**[STREAM/PCM]:** select when you connect the digital input of an amplifier with a built-in DTS, MPEG Multichannel or Dolby Digital decoder, or the stand-alone unit of such a decoder.

- With some DVD VIDEO discs that are not fully copy-protected, a 20 or 24 bit digital signal may be output.
- When playing a DVD VIDEO or Audio CD disc with DTS, use a DTS decoder to get correct signals from your speakers.

### ANALOG DOWN MIX

To correctly play the audio on a DVD VIDEO disc recorded with surround multichannel audio, you must set this item properly according to your audio system configuration.

#### Setting options

##### DOLBY SURROUND, STEREO

**[DOLBY SURROUND]:** select when listening to multichannel surround audio with the player's analog AUDIO OUT terminals connected to a surround decoder.

**[STEREO]:** select when listening to conventional two-channel stereo audio with the player's AUDIO OUT terminals connected to a stereo amplifier/receiver or television set, or in case you want to record the audio from a DVD VIDEO disc to MiniDisc, cassette, etc.

### D. RANGE CONTROL

This setting provides optimal audio quality from the analog AUDIO OUT terminals for listening to DVD VIDEO discs recorded in Dolby Digital format, at low or middle volume.

#### Setting options

##### WIDE RANGE, NORMAL, TV MODE

**[WIDE RANGE]:** when selected, audio is played back with the widest dynamic range so that you can enjoy powerful playback sound.

**[NORMAL]:** normally, select this option.

**[TV MODE]:** select if DVD VIDEO disc sound level is lower than TV program sound level. Thus you can hear sound at a lower volume clearly.

## OUTPUT LEVEL

This setting allows you to attenuate the level of the signal output from the player's analog AUDIO OUT terminals.

### Setting options

#### STANDARD, LOW

- If the sound output from the speaker is distorted, select [LOW].

## OTHERS menu

For the XV-N315B/XV-N316S, available items on the OTHERS menu differ from those of the XV-N310B/XV-N312S/XV-N210B/XV-N212S. Refer to the separate sheet for additional information.

## RESUME

You can select the resume playback mode.

See page 11 for details about the resume playback function.

### Setting options

#### ON, OFF, DISC RESUME

**[ON]:** when selected, the player can resume playback of the disc from the position where playback was last interrupted, if the disc is still in the disc tray.

**[OFF]:** when selected, the resume function is deactivated.

**[DISC RESUME]:** when selected, the player can resume playback of the last 30 discs played. The player retains a memory of the interrupted positions of the last 30 discs played, even though they have been removed from the disc tray.

## ON SCREEN GUIDE

The player can display “on-screen guide” icons or characters on the picture, which show what is happening to the disc or the player.

Example of “on-screen guide” icons: 

### Setting options

#### ON, OFF

**[ON]:** when selected, the on-screen guide is activated.

## AUTO STANDBY

When the player is stopped for more than 30 minutes or 60 minutes, the player enters standby mode automatically.

### Setting options

#### 60, 30, OFF

## PARENTAL LOCK

When this option is selected, pressing ENTER on the remote control unit brings up the PARENTAL LOCK display shown below. This allows you to restrict children from playing DVD VIDEO discs.

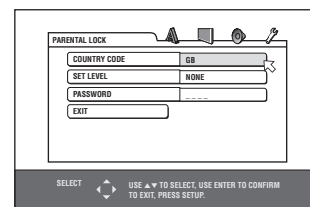

- See page 28 for details about the parental lock setting.

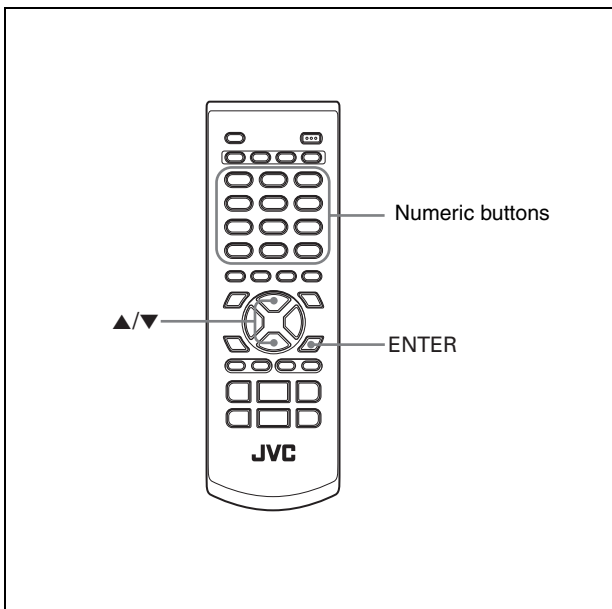

## Limiting playback by children

This function restricts playback of DVD VIDEO discs which contain violent (and other) scenes according to the level set by the user. For example, if a movie which includes violent scenes supports the parental lock feature, such scenes which you do not want to let children view can be cut or replaced with other scenes.

### To set Parental Lock for the first time



- 1** In stop mode, bring up the OTHERS menu.
- 2** Press ▲/▼ to move to select [PARENTAL LOCK] then press ENTER.

The Parental Lock on-screen display appears on the TV screen.

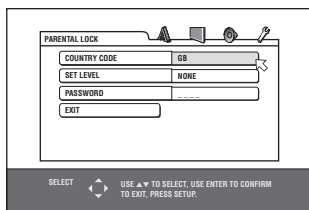

- 3** While is pointing to [COUNTRY CODE], press ENTER to bring up the pull-down menu.

- 4** Press ▲/▼ to select the country code.

Select the code of the country whose standards were used to rate the DVD VIDEO disc content.

See "Appendix A: Country/Area code list for Parental Lock" on page 32.

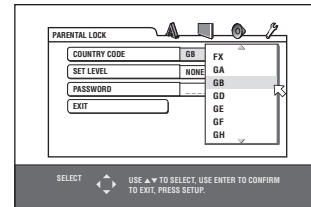

- 5** Press ENTER.

moves to [SET LEVEL].

- 6** Press ENTER to bring up the pull-down menu.

In the pull-down menu, [NONE] and levels [8] to [1] are available.

[NONE] does not restrict playback. Level [1] is the strictest level. Discs rated higher than the selected level are restricted.

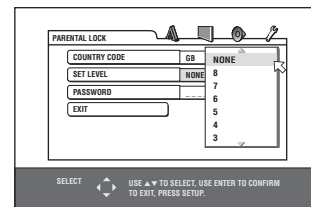

- 7** Press ▲/▼ to select a desired parental lock level, then press ENTER.

moves to [PASSWORD].

- 8** Press the numeric buttons (0 to 9) to enter a 4-digit password.

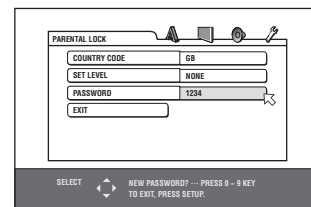

- 9** Press ENTER.

The parental lock feature is set.

moves to [EXIT]. Pressing ENTER again returns to the [OTHERS] menu of the preference display.

#### Hint

If you want to change the password at step 8, do it before pressing ENTER.



## To change the settings



You can change the parental lock settings later.

- 1 In stop mode, bring up the OTHERS menu.**
- 2 Press ▲/▼ to move  to select [PARENTAL LOCK] and press ENTER.**

The parental lock on-screen display appears on the TV screen.
- 3 While  is pointing to [PASSWORD], press the numeric buttons to enter your current 4-digit password then press ENTER.**

 moves to [COUNTRY CODE] if you enter the correct password.  
If you enter a wrong password, [WRONG! RETRY...] appears on the TV screen, and you cannot go to the next step. If you forget your password, enter "8888." The current password is deleted and you can set a new password.
- 4 To change the [COUNTRY CODE] or [SET LEVEL], press ENTER to bring up the associated pull-down menu when  is pointing to the desired item.**
- 5 Press ▲/▼ to select the desired option then press ENTER.**

If you change the country code, you must reselect the parental lock level.
- 6 While  is pointing to [PASSWORD], press the numeric buttons to enter a 4-digit password.**

The password entered in this step becomes the new password. If you want to keep the same password as before, enter the same password.
- 7 Press ENTER.**

 moves to [EXIT]. Pressing ENTER again returns to the [OTHERS] menu of the preference display.

### NOTE

If you enter the wrong password more than 3 times in step 3 above,  moves to [EXIT] automatically and ▲/▼ do not work.

## To temporarily release the Parental Lock



If the parental level is set to a strict value, some discs may not play at all. When you insert such a disc and try to play it, the following parental lock on-screen display appears on the TV screen, asking you whether you want the parental lock to be temporarily released or not.

- 1 Press ▲/▼ to move  to [TEMPORARY RELEASE], then press ENTER.**

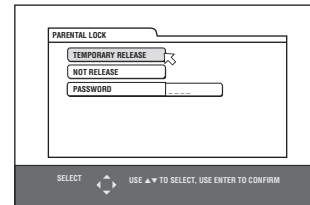

- 2 Press the numeric buttons (0 to 9) to enter your 4-digit password.**

The parental lock is released, and the player starts playback. If you enter a wrong password, [WRONG! RETRY...] appears on the TV screen. Enter the correct password.

### NOTE

When you enter the wrong password 3 times at step 2 above,  moves to [NOT RELEASE] automatically and ▲/▼ do not work.

# Additional information

## Troubleshooting

### Power

#### Power does not come on.

- ➔ Power plug is not inserted securely. Plug in securely.

### Operation

#### “REGION CODE ERROR!” is shown on the TV screen.

- ➔ Region code of the inserted disc does not match the player.  
Check the region code of the disc printed on the disc jacket.

#### Operation is not possible.

- ➔ Microcomputer malfunction due to lightning or static electricity.  
Turn off the power and unplug the power cord, then connect the power cord again.
- ➔ Moisture condensation caused by a sudden change of temperature or humidity. Turn off the power, then turn it on a few hours later.
- ➔ The disc does not allow the operation, or an unplayable disc is inserted. Check and replace the disc (see page 2).

#### [LOCK] is displayed on the display window and the disc tray does not open.

- ➔ When you press ▲ while pressing down ■ on the player in standby mode, the tray lock function is activated. The disc tray cannot be opened or closed in this status. To release this status, press ▲ while pressing down ■ on the player in standby mode.

### Picture

#### Picture is noisy.

- ➔ The player is connected to a VCR directly and the copyguard function is activated. Connect the player so that the picture signal flows directly to the TV.
- ➔ With some discs, the picture may be blurred when [PICTURE SOURCE] is set to [FILM] or [AUTO]. Set [PICTURE SOURCE] to [VIDEO (NORMAL)] or [VIDEO (ACTIVE)].

#### No picture is displayed on the TV screen or the screen is blurred or divided into two parts. (for XV-N310B/XV-N312S/XV-N315B/XV-N316S)

- ➔ The player is in the progressive scanning mode though it is connected to a TV via the VIDEO jack or via the SCART connector. Observe the display window. If [P] is turned on, the player is in the progressive scanning mode. Make the Progressive scanning mode inactive by using the VFP - I/P button. (See page 6.)

### Audio

#### DVD VIDEO disc playback sound level is lower than TV broadcast sound level.

- ➔ Set the [D.RANGE CONTROL] preference to [TV MODE] (see page 27).

#### Analog audio output is distorted.

- ➔ Set the [OUTPUT LEVEL] preference to [LOW] (see page 27).

### MP3/JPEG/MPEG-4

#### No sound and/or no picture comes out.

- ➔ MP3/MPEG-4 disc is recorded with the “packet writing (UDF file).” It cannot be played.
- ➔ Check the files you want to play back.

#### Files (tracks) are not played in the recorded order.

- ➔ This player plays the files in the alphabetic order. So, the playback order can vary.

#### MPEG-4 files cannot be played back.

- ➔ The format of the file is not asf.



## Specifications

Specifications and appearance are subject to change without prior notice.

### General

Readable discs	DVD VIDEO, DVD-R (Video format), DVD-RW (Video format), SVCD, Video CD, Audio CD (CD-DA), CD-R/RW (CD-DA, SVCD, Video CD, MP3 format, JPEG, MPEG-4)
Video format	PAL (For XV-N310B/XV-N312S/XV-N315B/XV-N316S only: Interlace scan/Progressive scan selectable)

### Other

Power requirements	AC 230 V $\sim$ , 50 Hz
Power consumption	11.0 W (POWER ON), 2.0 W (STANDBY mode)
Mass	1.6 kg
Dimensions (W $\times$ H $\times$ D)	435 mm $\times$ 44 mm $\times$ 201 mm

### Video outputs

VIDEO OUT (pin jack)	1.0 Vp-p (75 $\Omega$ )
RGB Output	700 mVp-p (75 $\Omega$ )
COMPONENT (pin jacks) (for XV-N310B/XV-N312S/XV-N315B/XV-N316S)	Y Output: 1.0 Vp-p (75 $\Omega$ ) P <sub>B</sub> /P <sub>R</sub> Output: 0.7 Vp-p (75 $\Omega$ )
Horizontal resolution	500 lines or more

### Audio outputs

ANALOG OUT (pin jack)	2.0 V <sub>rms</sub> (10 k $\Omega$ )
DIGITAL OUT (COAXIAL)	0.5 Vp-p (75 $\Omega$ termination)

### Audio characteristics

Frequency response	CD (sampling frequency 44.1 kHz): 2 Hz to 20 kHz DVD (sampling frequency 48 kHz): 2 Hz to 22 kHz (4 Hz to 20 kHz for DTS and Dolby Digital bitstream signals) DVD (sampling frequency 96 kHz): 2 Hz to 44 kHz
Dynamic range	16 bit: More than 98 dB 20 bit/24 bit: More than 100 dB
Wow and flutter	Unmeasurable (less than $\pm$ 0.002%)
Total harmonic distortion	less than 0.009%

- Manufactured under license from Dolby Laboratories. "Dolby" and the double-D symbol are trademarks of Dolby Laboratories.
- "DTS" and "DTS 2.0+Digital Out" are trademarks of Digital Theater Systems, Inc.
- USE OF THIS PRODUCT IN ANY MANNER THAT COMPLIES WITH THE MPEG-4 VISUAL STANDARD IS PROHIBITED, EXCEPT FOR USE BY A CONSUMER ENGAGING IN PERSONAL AND NON-COMMERCIAL ACTIVITIES.
- This product incorporates copyright protection technology that is protected by method claims of certain U.S. patents and other intellectual property rights owned by Macrovision Corporation and other rights owners. Use of this copyright protection technology must be authorized by Macrovision Corporation, and is intended for home and other limited viewing uses only unless otherwise authorized by Macrovision Corporation. Reverse engineering or disassembly is prohibited.

- "CONSUMERS SHOULD NOTE THAT NOT ALL HIGH DEFINITION TELEVISION SETS ARE FULLY COMPATIBLE WITH THIS PRODUCT AND MAY CAUSE ARTIFACTS TO BE DISPLAYED IN THE PICTURE. IN CASE OF 525 OR 625 PROGRESSIVE SCAN PICTURE PROBLEMS, IT IS RECOMMENDED THAT THE USER SWITCH THE CONNECTION TO THE 'STANDARD DEFINITION' OUTPUT. IF THERE ARE QUESTIONS REGARDING OUR TV SET COMPATIBILITY WITH THIS MODEL 525p AND 625p DVD PLAYER, PLEASE CONTACT OUR CUSTOMER SERVICE CENTER."

# Appendix A: Country/Area code list for Parental Lock

(for page 28)

AD	Andorra	ER	Eritrea	LA	Lao People's Democratic Republic	RW	Rwanda
AE	United Arab Emirates	ES	Spain	LB	Lebanon	SA	Saudi Arabia
AF	Afghanistan	ET	Ethiopia	LC	Saint Lucia	SB	Solomon Islands
AG	Antigua and Barbuda	FI	Finland	LI	Liechtenstein	SC	Seychelles
AI	Anguilla	FJ	Fiji	LK	Sri Lanka	SD	Sudan
AL	Albania	FK	Falkland Islands	LR	Liberia	SE	Sweden
AM	Armenia	FM	Micronesia (Federated States of)	LS	Lesotho	SG	Singapore
AN	Netherlands Antilles	FO	Faroe Islands	LT	Lithuania	SH	Saint Helena
AO	Angola	FR	France	LU	Luxembourg	SI	Slovenia
AQ	Antarctica	FX	France, Metropolitan	LV	Latvia	SJ	Svalbard and Jan Mayen
AR	Argentina	GA	Gabon	LY	Libyan Arab Jamahiriya	SK	Slovakia
AS	American Samoa	GB	United Kingdom	MA	Morocco	SL	Sierra Leone
AT	Austria	GD	Grenada	MC	Monaco	SM	San Marino
AU	Australia	GE	Georgia	MD	Moldova, Republic of	SN	Senegal
AW	Aruba	GF	French Guiana	MG	Madagascar	SO	Somalia
AZ	Azerbaijan	GH	Ghana	MH	Marshall Islands	SR	Suriname
BA	Bosnia and Herzegovina	GI	Gibraltar	ML	Mali	ST	Sao Tome and Principe
BB	Barbados	GL	Greenland	MM	Myanmar	SV	El Salvador
BD	Bangladesh	GM	Gambia	MN	Mongolia	SY	Syrian Arab Republic
BE	Belgium	GN	Guinea	MO	Macau	SZ	Swaziland
BF	Burkina Faso	GP	Guadeloupe	MP	Northern Mariana Islands	TC	Turks and Caicos Islands
BG	Bulgaria	GQ	Equatorial Guinea	MQ	Martinique	TD	Chad
BH	Bahrain	GR	Greece	MR	Mauritania	TF	French Southern Territories
BI	Burundi	GS	South Georgia and the South Sandwich	MS	Montserrat	TG	Togo
BJ	Benin	GT	Guatemala	MT	Malta	TH	Thailand
BM	Bermuda	GU	Guam	MU	Mauritius	TJ	Tajikistan
BN	Brunei Darussalam	GV	Guinea-Bissau	MV	Maldives	TK	Tokelau
BO	Bolivia	GY	Guyana	MW	Malawi	TM	Turkmenistan
BR	Brazil	HK	Hong Kong	MX	Mexico	TN	Tunisia
BS	Bahamas	HM	Heard Island and McDonald Islands	MY	Malaysia	TO	Tonga
BT	Bhutan	HN	Honduras	MZ	Mozambique	TP	East Timor
BV	Bouvet Island	HR	Croatia	NA	Namibia	TR	Turkey
BW	Botswana	HT	Haiti	NC	New Caledonia	TT	Trinidad and Tobago
BY	Belarus	HU	Hungary	NE	Niger	TV	Tuvalu
BZ	Belize	ID	Indonesia	NF	Norfolk Island	TW	Taiwan
CA	Canada	IE	Ireland	NG	Nigeria	TZ	Tanzania, United Republic of
CC	Cocos (Keeling) Islands	IL	Israel	NI	Nicaragua	UA	Ukraine
CF	Central African Republic	IN	India	NL	Netherlands	UG	Uganda
CG	Congo	IO	British Indian Ocean Territory	NO	Norway	UM	United States Minor Outlying Islands
CH	Switzerland	IQ	Iraq	NP	Nepal	US	United States
CI	Côte d'Ivoire	IR	Iran (Islamic Republic of)	NR	Nauru	UY	Uruguay
CK	Cook Islands	IS	Iceland	NU	Niue	UZ	Uzbekistan
CL	Chile	IT	Italy	NZ	New Zealand	VA	Vatican City State (Holy See)
CM	Cameroon	JM	Jamaica	OM	Oman	VC	Saint Vincent and the Grenadines
CN	China	JO	Jordan	PA	Panama	VE	Venezuela
CO	Colombia	JP	Japan	PE	Peru	VG	Virgin Islands (British)
CR	Costa Rica	KE	Kenya	PF	French Polynesia	VI	Virgin Islands (U.S.)
CU	Cuba	KG	Kyrgyzstan	PG	Papua New Guinea	VN	Vietnam
CV	Cape Verde	KH	Cambodia	PH	Philippines	VU	Vanuatu
CX	Christmas Island	KI	Kiribati	PK	Pakistan	WF	Wallis and Futuna Islands
CY	Cyprus	KM	Comoros	PL	Poland	WS	Samoa
CZ	Czech Republic	KN	Saint Kitts and Nevis	PM	Saint Pierre and Miquelon	YE	Yemen
DE	Germany	KP	Korea, Democratic People's Republic of	PN	Pitcairn	YT	Mayotte
DJ	Djibouti	KR	Korea, Republic of	PR	Puerto Rico	YU	Yugoslavia
DK	Denmark	KW	Kuwait	PT	Portugal	ZA	South Africa
DM	Dominica	KY	Cayman Islands	PW	Palau	ZM	Zambia
DO	Dominican Republic	KZ	Kazakhstan	PY	Paraguay	ZR	Zaire
DZ	Algeria			QA	Qatar	ZW	Zimbabwe
EC	Ecuador			RE	Réunion		
EE	Estonia			RO	Romania		
EG	Egypt			RU	Russian Federation		
EH	Western Sahara						

## Appendix B: Table of languages and their abbreviations

(for pages 17 and 26)

AA	Afar	FA	Persian	KM	Cambodian	OM	(Afan) Oromo	SU	Sundanese
AB	Abkhazian	FI	Finnish	KN	Kannada	OR	Oriya	SV	Swedish
AF	Afrikaans	FJ	Fiji	KO	Korean (KOR)	PA	Panjabi	SW	Swahili
AM	Ameharic	FO	Faroese	KS	Kashmiri	PL	Polish	TA	Tamil
AR	Arabic	FY	Frisian	KU	Kurdish	PS	Pashto, Pushto	TE	Telugu
AS	Assamese	GA	Irish	KY	Kirghiz	PT	Portuguese	TG	Tajik
AY	Aymara	GD	Scots Gaelic	LA	Latin	QU	Quechua	TH	Thai
AZ	Azerbaijani	GL	Galician	LN	Lingala	RM	Rhaeto-Romance	TI	Tigrinya
BA	Bashkir	GN	Guarani	LO	Laothian	RN	Kirundi	TK	Turkmen
BE	Byelorussian	GU	Gujarati	LT	Lithuanian	RO	Rumanian	TL	Tagalog
BG	Bulgarian	HA	Hausa	LV	Latvian, Lettish	RU	Russian	TN	Setswana
BH	Bihari	HI	Hindi	MG	Malagasy	RW	Kinyarwanda	TO	Tongan
BI	Bislama	HR	Croatian	MI	Maori	SA	Sanskrit	TR	Turkish
BN	Bengali, Bangla	HU	Hungarian	MK	Macedonian	SD	Sindhi	TS	Tsonga
BO	Tibetan	HY	Armenian	ML	Malayalam	SG	Sangho	TT	Tatar
BR	Breton	IA	Interlingua	MN	Mongolian	SH	Serbo-Croatian	TW	Twi
CA	Catalan	IE	Interlingue	MO	Moldavian	SI	Singhalese	UK	Ukrainian
CO	Corsican	IK	Inupiak	MR	Marathi	SK	Slovak	UR	Urdu
CS	Czech	IN	Indonesian	MS	Malay (MAY)	SL	Slovenian	UZ	Uzbek
CY	Welsh	IS	Icelandic	MT	Maltese	SM	Samoan	VI	Vietnamese
DA	Danish	IW	Hebrew	MY	Burmese	SN	Shona	VO	Volapuk
DZ	Bhutani	JI	Yiddish	NA	Nauru	SO	Somali	WO	Wolof
EL	Greek	JW	Javanese	NE	Nepali	SQ	Albanian	XH	Xhosa
EO	Esperanto	KA	Georgian	NL	Dutch	SR	Serbian	YO	Yoruba
ET	Estonian	KK	Kazakh	NO	Norwegian	SS	Siswati	ZU	Zulu
EU	Basque	KL	Greenlandic	OC	Occitan	ST	Sesotho		

# Appendix C: Digital output signal chart

(for page 27)

Disc type	Output		
	PCM ONLY	DOLBY DIGITAL/PCM	STREAM/PCM
DVD with 48/44.1 kHz, 16/20/24 bit linear PCM	48/44.1 kHz, 16 bit, stereo linear PCM		
DVD with DTS	48 kHz, 16 bit, stereo linear PCM		DTS bitstream
DVD with Dolby Digital	48 kHz, 16 bit, stereo linear PCM	Dolby Digital bitstream	
DVD with MPEG Multichannel	48 kHz, 16 bit, stereo linear PCM		MPEG bitstream
SVCD/Video CD/Audio CD	44.1 kHz, 16 bit, stereo linear PCM		
Audio CD with DTS	48 kHz, 16 bit, stereo linear PCM		DTS bitstream
CD-R/RW with MP3	Linear PCM		
CD-R/RW with MPEG-4	No output		

## Appendix D: Glossary

### ASF

ASF is an abbreviation of "Advanced Streaming Format," and is a data compression format for streaming developed by Microsoft Corporation. ASF can contain the various data types such as audio, video, and text.

### Aspect ratio

A ratio which defines the shape of the rectangular picture in a TV. It is the width of the picture relative to the height. A conventional TV picture is 4:3 in aspect ratio.

### Bitstream

The digital form of multichannel audio data (e.g., 5.1-channel) before it is decoded into its various channels.

### Chapter/title

Chapter is the smallest division and title is the largest division on DVD VIDEO. A chapter is a division of a title and similar to a track for Video CD or Audio CD.

### Component video

Video signals with three channels of separate information that makes up the picture. There are some types of component video, such as R/G/B and Y/C<sub>B</sub>(P<sub>B</sub>)/C<sub>R</sub>(P<sub>R</sub>).

### Composite video

A single video signal commonly used in most consumer video products that contains all luminance, color, and synchronization information.

### Dolby Digital (AC3)

A six-channel system consisting of left, center, right, left rear, right rear and LFE (Low-Frequency Effect channel, for use with a sub-woofer) channels. All processing is done in the digital domain. Not all Dolby Digital discs contain six (5.1) channels of information.

### Dolby Surround/Dolby Pro Logic

Dolby Surround records four channels of front and rear audio in two channels in a way that allows a decoder to recover the original four channels for playback. Because the audio is recorded in two channels, it can be played back naturally by a two-channel stereo system.

Dolby Pro Logic introduces directional circuits in decoder-side processing (increasing the level of specific channels and lowering the level of silent channels) for greater spatial perspective, and adds a center speaker used primarily for dialog. The result is enhanced channel separation.

### Down-mix

Internal stereo mix of multichannel surround audio by a DVD player. The down-mix signals are output from stereo output connectors.

### DTS

A Digital Surround audio encoding format configured with six (5.1) channels, similar to Dolby Digital. It requires a decoder, either in the player or in an external receiver. DTS stands for Digital Theater Systems.

Not all DTS discs contain six (5.1) channels of information.

### Dynamic range

The difference between the loudest and softest sounds.

### Interlaced scanning

In a conventional video system, a picture is shown on the display monitor in between lines of two halves. The Interlaced scanning system places lines of the second half of the picture in-between lines of the first half of the picture.

### JPEG

A popular file format for still image compression and storage. JPEG stands for Joint Photographic Experts Group.

There are three sub-types of the JPEG format as follows.

- baseline JPEG: used for digital cameras, the web, etc.
- progressive JPEG: used for the web
- lossless JPEG: an old type, rarely used now

### Linear PCM audio

PCM stands for "pulse code modulation." Linear PCM is the usual method for digitally encoding audio without compression, and is used for the audio tracks on DVD VIDEO discs, Audio CDs, etc.

### MP3

MP3 is an audio data compression format, which stands for MPEG-1 Audio Layer 3. Using MP3, you can achieve a data reduction of about 1:10.

### MPEG-4

MPEG-4 is an audio/video data compression format, which is highly efficient and more stable than MPEG-1 and MPEG-2.

### MPEG Multichannel

This feature expands the 5.1 channel audio format recorded on the disc to a 7.1 channel format. The further expansion of the 5.1 channel audio makes it easy for you to reproduce the movie theater experience in your own home.

### PAL (Phase Alternation by Line)

A color television system format used extensively in Western Europe.

### PBC

PBC stands for "Playback control" and is a method of controlling disc play for Video CDs (VCD). You are able to interact with the disc through menus.

### Progressive scanning

Progressive scanning displays all the horizontal lines of a picture at one time, as a single frame. A progressive scanning DVD player converts the interlaced video from DVD into progressive format for connection to a progressive display. It dramatically increases the vertical resolution.

### RGB

An abbreviation for Red, Green and Blue. Color monitors and color television sets display different hues by mixing these three colors.

### Track

The smallest division on SVCD, Video CD and Audio CD discs.

## SAFETY INSTRUCTIONS

### "SOME DOS AND DON'TS ON THE SAFE USE OF EQUIPMENT"

This equipment has been designed and manufactured to meet international safety standards but, like any electrical equipment, care must be taken if you are to obtain the best results and safety is to be assured.

Do read the operating instructions before you attempt to use the equipment.

Do ensure that all electrical connections (including the mains plug, extension leads and interconnections between pieces of equipment) are properly made and in accordance with the manufacturer's instructions. Switch off and withdraw the mains plug when making or changing connections.

Do consult your dealer if you are ever in doubt about the installation, operation or safety of your equipment.

Do be careful with glass panels or doors on equipment.

DON'T continue to operate the equipment if you are in any doubt about it working normally, or if it is damaged in any way—switch off, withdraw the mains plug and consult your dealer.

DON'T remove any fixed cover as this may expose dangerous voltages.

DON'T leave equipment switched on when it is unattended unless it is specifically stated that it is designed for unattended operation or has a standby mode.

Switch off using the switch on the equipment and make sure that your family know how to do this.

Special arrangements may need to be made for infirm or handicapped people.

DON'T use equipment such as personal stereos or radios so that you are distracted from the requirements of traffic safety. It is illegal to watch television whilst driving.

DON'T listen to headphones at high volume as such use can permanently damage your hearing.

DON'T obstruct the ventilation of the equipment, for example with curtains or soft furnishings.

Overheating will cause damage and shorten the life of the equipment.

DON'T use makeshift stands and NEVER fix legs with wood screws — to ensure complete safety always fit the manufacturer's approved stand or legs with the fixings provided according to the instructions.

DON'T allow electrical equipment to be exposed to rain or moisture.

ABOVE ALL

- NEVER let anyone, especially children, push anything into holes, slots or any other opening in the case -this could result in a fatal electrical shock.;
- NEVER guess or take chances with electrical equipment of any kind -it is better to be safe than sorry!

**JVC**  
VICTOR COMPANY OF JAPAN, LIMITED