





HITACHI MODEL DV-P533U

Inspire the Next

DVD PLAYER INSTRUCTION MANUAL

WARNING: TO REDUCE THE RISK OF FIRE OR ELECTRIC SHOCK, DO NOT EXPOSE THIS APPLIANCE TO RAIN OR MOISTURE.

| | | |
|---|---|---|
|  | CAUTION RISK OF ELECTRIC SHOCK DO NOT OPEN |  |
| <p>CAUTION: TO REDUCE THE RISK OF ELECTRIC SHOCK, DO NOT REMOVE COVER (OR BACK). NO USER SERVICEABLE PARTS INSIDE. REFER SERVICING TO QUALIFIED SERVICE PERSONNEL.</p> | | |

| | |
|---|--|
|  | <p>The lightning flash with arrowhead symbol, within an equilateral triangle, is intended to alert the user to the presence of uninsulated "dangerous voltage" within the product's enclosure that may be of sufficient magnitude to constitute a risk of electric shock to persons.</p> |
|  | <p>The exclamation point within an equilateral triangle is intended to alert the user to the presence of important operating and maintenance (servicing) instructions in the literature accompanying the appliance.</p> |

IMPORTANT SAFEGUARDS

- 1) Read Instructions - All the safety and operating instructions should be read before the product is operated.
- 2) Retain Instructions - The safety and operating instructions should be retained for future reference.
- 3) Heed Warnings - All warnings on the product and in the operating instructions should be adhered to.
- 4) Follow Instructions - All operating and use instructions should be followed.
- 5) Cleaning - Unplug this product from the wall outlet before cleaning. Do not use liquid cleaners or aerosol cleaners. Use a damp cloth for cleaning.
- 6) Attachments - Do not use attachments not recommended by the product manufacturer as they may cause hazards.
- 7) Water and Moisture - Do not use this product near water - for example, near a bath tub, wash bowl, kitchen sink, or laundry tub; in a wet basement; or near a swimming pool; and the like.
- 8) Accessories - Do not place this product on an unstable cart, stand, tripod, bracket, or table. The product may fall, causing serious injury to a child or adult, and serious damage to the product. Use only with a cart, stand, tripod, bracket, or table recommended by the manufacturer, or sold with the product. Any mounting of the product should follow the manufacturer's instructions, and should use a mounting accessory recommended by the manufacturer.
- 9) A product and cart combination should be moved with care. Quick stops, excessive force, and uneven surfaces may cause the product and cart combination to overturn.
- 10) Ventilation - Slots and openings in the cabinet are provided for ventilation and to ensure reliable operation of the product and to protect it from overheating, and these openings must not be blocked or covered. The openings should never be blocked by placing the product on a bed, sofa, rug, or other similar surface. This product should not be placed in a built-in installation such as a bookcase or rack unless proper ventilation is provided or the manufacturer's instructions have been adhered to.
- 11) Power Sources - This product should be operated only from the type of power source indicated on the marking label. If you are not sure of the type of power supply to your home, consult your product dealer or local power company. For products intended to operate from battery power, or other sources, refer to the operating instructions.
- 12) Grounding or Polarization - This product may be equipped with a polarized alternating-current line plug (a plug having one blade wider than the other). This plug will fit into the power outlet only one way. This is a safety feature. If you are unable to insert the plug fully into the outlet, try reversing the plug. If the plug should still fail to fit, contact your electrician to replace your obsolete outlet. Do not defeat the safety purpose of the polarized plug.
- 13) Power-Cord Protection - Power-supply cords should be routed so that they are not likely to be walked on or pinched by items placed upon or against them, paying particular attention to cords at plugs, convenience receptacles, and the point where they exit from the product.
- 14) Lightning - For added protection for this product during a lightning storm, or when it is left unattended and unused for long periods of time, unplug it from the wall outlet and disconnect the antenna or cable system. This will prevent damage to the product due to lightning and power-line surges.
- 15) Power lines - An outside antenna system should not be located in the vicinity of overhead power lines or other electric light or power circuits, or where it can fall into such power lines or circuits. When installing an outside antenna system, extreme care should be taken to keep from touching such power lines or circuits as contact with them might be fatal.
- 16) Overloading - Do not overload wall outlets, extension cords, or integral convenience receptacles as this can result in a risk of fire or electric shock.
- 17) Object and Liquid Entry - Never push objects of any kind into this product through openings as they may touch dangerous voltage points or short-out parts that could result in a fire or electric shock. Never spill liquid of any kind on the product.
- 18) Servicing - Do not attempt to service this product yourself as opening or removing covers may expose you to dangerous voltage or other hazards. Refer all servicing to qualified service personnel.
- 19) Damage Requiring Service - Unplug this product from the wall outlet and refer servicing to qualified service personnel under the following conditions:
 - a) When the power-supply cord or plug is damaged,
 - b) If liquid has been spilled, or objects have fallen into the product,
 - c) If the product has been exposed to rain or water,
 - d) If the product does not operate normally by following the operating instructions. Adjust only those controls that are covered by the operating instructions as an improper adjustment of other controls may result in damage and will often require extensive work by a qualified technician to restore the product to its normal operation,
 - e) If the product has been dropped or damaged in any way, and
 - f) When the product exhibits a distinct change in performance - this indicates a need for service.
- 20) Replacement Parts - When replacement parts are required, be sure the service technician has used replacement parts specified by the manufacturer or have the same characteristics as the original part. Unauthorized substitutions may result in fire, electric shock, or other hazards.
- 21) Safety Check - Upon completion of any service or repairs to this product, ask the service technician to perform safety checks to determine that the product is in proper operating condition.
- 22) Heat - The product should be situated away from heat sources such as radiators, heat registers, stoves, or other products (including amplifiers) that produce heat.

PORTABLE CART WARNING
(Symbol provided by RETAC)



S3125A

INSTRUCCIONES EN ESPAÑOL INCLUIDAS.

Instruction manual

To obtain the best performance and ensure years of trouble-free use, please read this instruction manual completely.

PRECAUTIONS

LASER SAFETY

This player employs a laser. Only a qualified service person should remove the cover or attempt to service this device, due to possible eye injury.

CAUTION: USE OF CONTROLS OR ADJUSTMENTS OR PERFORMANCE OF PROCEDURES OTHER THAN THOSE SPECIFIED HEREIN MAY RESULT IN HAZARDOUS RADIATION EXPOSURE.

CAUTION: VISIBLE AND INVISIBLE LASER RADIATION WHEN OPEN AND INTERLOCK DEFEATED. DO NOT STARE INTO BEAM.

LOCATION: INSIDE, ON THE DECK MECHANISM.

FCC WARNING- This equipment may generate or use radio frequency energy. Changes or modifications to this equipment may cause harmful interference unless the modifications are expressly approved in the instruction manual. The user could lose the authority to operate this equipment if an unauthorized change or modification is made.

RADIO-TV INTERFERENCE

This equipment has been tested and found to comply with the limits for a Class B digital device, pursuant to Part 15 of the FCC Rules. These limits are designed to provide reasonable protection against harmful interference in a residential installation. This equipment generates, uses, and can radiate radio frequency energy and, if not installed and used in accordance with the instructions, may cause harmful interference to radio communications. However, there is no guarantee that interference will not occur in a particular installation. If this equipment does cause harmful interference to radio or television reception, which can be determined by turning the equipment off and on, the user is encouraged to try to correct the interference by one or more of the following measures:

- 1) Reorient or relocate the receiving antenna.
- 2) Increase the separation between the equipment and receiver.
- 3) Connect the equipment into an outlet on a circuit different from that to which the receiver is connected.
- 4) Consult the dealer or an experienced radio/TV technician for help.

This Class B digital apparatus complies with Canadian ICES-003.

Cet appareil numérique de la classe B est conforme à la norme NMB-003 du Canada.

CAUTION: TO PREVENT ELECTRIC SHOCK, MATCH WIDE BLADE OF PLUG TO WIDE SLOT, FULLY INSERT.

ATTENTION: POUR ÉVITER LES CHOC ÉLECTRIQUES, INTRODUIRE LA LAME LA PLUS LARGE DE LA FICHE DANS LA BORNE CORRESPONDANTE DE LA PRISE ET POUSSER JUSQU'AU FOND.

A NOTE ABOUT RECYCLING

This product's packaging materials are recyclable and can be reused. Please dispose of any materials in accordance with your local recycling regulations.

Batteries should never be thrown away or incinerated but disposed of in accordance with your local regulations concerning chemical wastes.

About Copyright

Unauthorized copying, broadcasting, public performance and lending of discs are prohibited.

This product incorporates copyright protection technology that is protected by method claims of certain U.S. patents and other intellectual property rights owned by Macrovision Corporation and other rights owners. Use of this copyright protection technology must be authorized by Macrovision Corporation, and is intended for home and other limited viewing uses only unless otherwise authorized by Macrovision Corporation. Reverse engineering or disassembly is prohibited.

TABLE OF CONTENTS

| | | | |
|--|---|--------------------------------------|----|
| ■ PRECAUTIONS | 2 | Fast Forward / Reverse Search | 10 |
| LASER SAFETY | 2 | Slow Forward / Slow Reverse | 10 |
| About Copyright | 2 | Zoom | 10 |
| ■ INTRODUCTION | 4 | Track | 10 |
| Supplied Accessories | 4 | Title / Chapter Search | 10 |
| Symbols Used in this Manual | 4 | Time Search | 10 |
| ■ ABOUT THE DISCS | 4 | Repeat | 10 |
| Playable Discs | 4 | REPEAT TITLE / CHAPTER | 10 |
| Disc Types | 4 | REPEAT TRACK | 11 |
| ■ FEATURES | 5 | A-B REPEAT | 11 |
| ■ FUNCTIONAL OVERVIEW | 6 | Program (CD) | 11 |
| FRONT PANEL | 6 | Random Playback (CD) | 11 |
| REAR VIEW | 6 | MP3 Playback | 11 |
| REMOTE CONTROL | 6 | On-Screen Information | 11 |
| Display | 7 | Track Selection | 12 |
| Displays During Operation | 7 | Random Playback (MP3) | 12 |
| Loading the Batteries | 7 | Program (MP3) | 12 |
| ■ HOOK UPS | 7 | Audio Language | 12 |
| Connecting to a TV using a VIDEO OUT Jack | | Stereo Sound Mode | 12 |
| or a S-VIDEO OUT Jack | 7 | Subtitle Language | 12 |
| Connecting to an Amplifier Equipped with Digital Input | | Camera Angle | 12 |
| Jacks such as MD deck or DAT deck | 8 | Changing the On-Screen Display | 12 |
| Connecting to a Dolby Digital decoder | 8 | Parental Control | 13 |
| Connecting to a TV or a Stereo TV that has Component | | PARENTAL LEVEL | 13 |
| VIDEO In Jacks | 8 | IF YOU FORGET THE PASSWORD | 13 |
| ■ PLAYING A DISC | 9 | CONTROL LEVELS | 13 |
| Basic Playback | 9 | Marker Setup Screen | 13 |
| General Features | 9 | ■ DVD SETUP | 13 |
| Pause | 9 | Audio Setting | 13 |
| Disc Menus | 9 | Black Level Setting | 13 |
| Title Menu | 9 | Virtual Surround | 13 |
| CALLING UP A MENU SCREEN DURING | | Display Setting | 14 |
| PLAYBACK | 9 | Language Setting | 14 |
| Step by Step Playback | 9 | ■ TROUBLESHOOTING GUIDE | 15 |
| Resume | 9 | ■ SPECIFICATIONS | 15 |
| | | ■ MAINTENANCE | 16 |

INDICE

| | | | |
|---|----|--|----|
| ■ CONTROLES DE OPERACIÓN Y FUNCIONES | 16 | Conexión a un Descodificador Dolby Digital | 17 |
| PANEL DELANTERO / VISTA TRASERA | 16 | Conexión a un Televisor o a un Televisor Estéreo Que | |
| MANDO A DISTANCIA | 16 | tenga tomas Component Video in | 18 |
| Visualización | 17 | ■ REPRODUCCIÓN DE UN DISCO | 18 |
| Visualizaciones Durante la Operación | 17 | Reproducción de un DVD de Vídeo o un CD de Audio | 18 |
| Instalación de las Pilas | 17 | | |
| ■ CONEXIONES | 17 | | |
| Conexión a un Televisor | 17 | | |
| Conexión a un Amplificador Equipado con tomas de | | | |
| Entrada Digital, Platina MD o Platina DAT | 17 | | |

INTRODUCTION

Supplied Accessories

- Remote control DV-RM533U(TS18311)
- Two AA batteries
- VIDEO/AUDIO cables approx.3 feet(100cm) long(TE14751)

Symbols Used in this Manual

The following symbols appear below in some headings and notes in this manual, with the following meanings!

DVD : Description refers to playback of DVD video discs.

CD : Description refers to playback of audio CDs.

MP3 : Description refers to playback of MP3 discs.

QUICK : Description refers to the items to be set in the QUICK mode.

ABOUT THE DISCS

Playable Discs

The following discs can be played back on this DVD player.

- DVD video
- DVD-R*
- Audio CD
- CD-R/RW*
- MP3*

*Depending on the types or the writing method of the medium some discs can not be played.

- Some DVD-R or CD-R/RW discs made on personal computers, or on DVD recorders may not be played back properly due to factors such as scratches, dirt or special properties of the disc.
- Discs made on personal computers may not be played back properly due to different environments or the settings of the application you use. We recommend always to use the standardized, properly formatted discs. (Please contact the sales agency for more detail).

This player conforms to the NTSC color system. You cannot play discs recorded in other color systems such as PAL or SECAM.

- Some discs include region codes as shown on the right.
- The number inside the symbol refers to a region of the world, and a disc encoded in a specific region format can only be played back on DVD player with the same region code.



For Customer Use:

Read carefully the information located at the bottom of your DVD player and enter below the Serial No. Retain this information for future reference.

Model No. DVD player

Serial No. _____

The following discs cannot be played back on this DVD player.

- DVD with region codes other than 1 or ALL.
- DVD-ROM
- DVD-RAM
- CD-ROM
- VSD
- CDV (Only plays back the audio part.)
- CD-G (Only plays back the sound.)
- CD-I
- SACD
- Photo CD
- Video CD

Any other discs without compatibility indications.

Disc Types

[Audio CD]

Data on an audio CD is divided into sections called "tracks", each of which is given a track number.

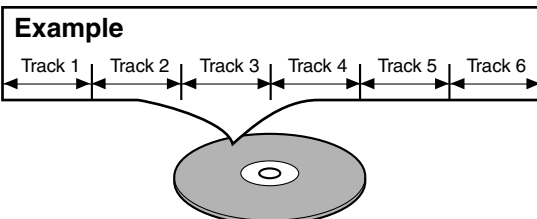

[MP3]

Data on a MP3 is divided into sections called "groups", and then into subsections called "tracks", each of which is given a group or track number.

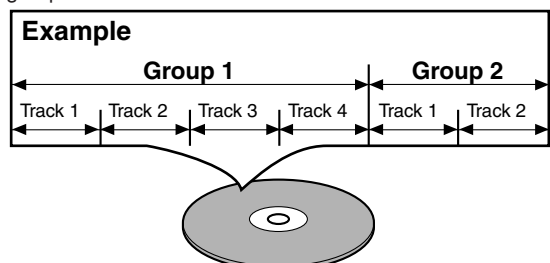

ABOUT THE DISCS

[DVD]

Data on a DVD is divided into sections called "titles", and then into subsections called "chapters", each of which is given a title or chapter number. Playback conditions are preset on some DVD video discs, and these playback conditions take priority over user operations on this player. If a function you selected do not run as desired, refer to the manual accompanying the disc.

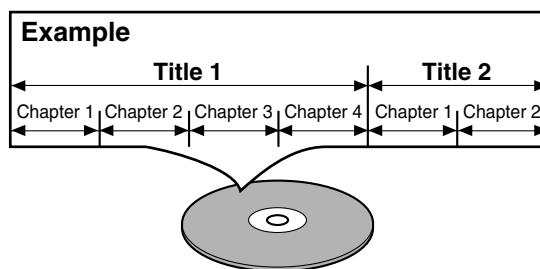

FEATURES

- **Progressive Scan system**
- **Dolby Digital sound Plays back**
This player plays back Dolby Digital surround sound having 5.1 channels when connected to a Dolby Digital decoder.
- **Still/fast/slow/step playback**
- **Random playback for audio CD and MP3**
- **Program playback for audio CD and MP3**
- **DVD menus in a desired language**
- **Screen saver/Auto power-off functions**
The screen saver program starts when there is no input from the player for five minutes in the stop mode. When the screen saver program is activated for 30 minutes, the power is automatically turned off.
- **Subtitles in a desired language**
- **Selecting a camera angle**
- **Choices for audio language and sound mode**
- **Parental lock**
- **Automatic detection of discs**
This player automatically detects if a loaded disc is DVD, audio CD or MP3 on disc.
- **Playing an MP3 disc**
- **Direct Search**
- **On-screen display**

Information about the current operation can be displayed on a TV screen, allowing you to confirm the currently active functions (such as program playback), on the TV screen using the remote control.

- **Search**
Chapter search / Title search / Track search / Time search
- **Repeat**
Chapter / Title / Track / Group / All / A-B
- **Zoom**
- **Marker**
An electronic references point designated by user can be called back.
- **Resume Play**
- **Virtual Surround**
- **Component Video Out Jacks**
Jacks located on the back of the DVD Player which are used to send high-quality Component Video to televisions equipped with component inputs.
- **Dimmer**
Dim the display brightness.
- **Bit rate indication**
- **DRC (Dynamic range control)**
You can control the range of sound volume.
- **Black Level Setting**

Manufactured under license from Dolby Laboratories. "Dolby" and the double-D symbol are trademarks of Dolby Laboratories.

Selecting Progressive Scan (480p or Interlaced 480i) Playback

- If your TV is compatible with progressive scanning (480p), connect the TV to the Component Video Output jacks of the DVD player and set the INTERLACE/PROGRESSIVE SCAN SELECTOR on the back of the DVD player to P(PROGRESSIVE). Next, set your TV to the progressive scan mode.
If your TV is not compatible with progressive scan, set the INTERLACE/PROGRESSIVE SCAN SELECTOR to I(INTERLACE).
- Use a commercially available adaptor if the video input jacks of your TVs or monitors are the BNC type.
- If you switch PROGRESSIVE/INTERLACE when the power is on, the DVD player will automatically be turned off. When you turn on the DVD player again, the last selected scanning system will be employed.

What is Progressive Scanning?

- Unlike conventional interlace scanning, the progressive scan system provides less flickering and images in higher resolution than that of traditional (480i) television signals.
- When P(PROGRESSIVE) is selected, no video signal will be output from the VIDEO OUT, or S-VIDEO OUT jack.

FUNCTIONAL OVERVIEW

FRONT PANEL

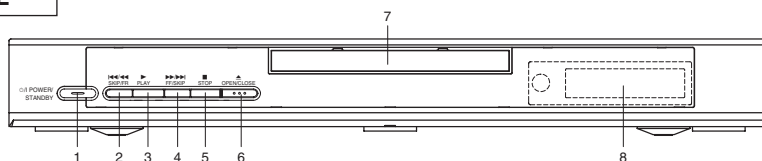

[Fig. 1]

REAR VIEW

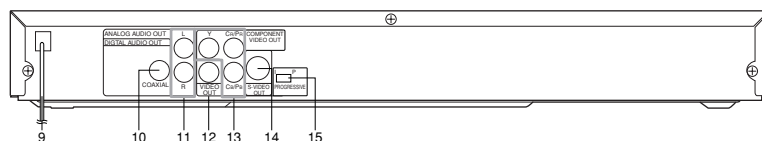

[Fig. 2]

1. **⏻/⏻ (POWER/STANDBY)**
to switch the player to ON or OFF
(As to the indication of the Operate switch, "I" indicates ON and "⏻" indicates electrical power STANDBY)
2. **SKIP/FR**
goes to previous chapter or track during playback; press and hold for 1.5 seconds for a reverse search
3. **PLAY**
to start or resume disc playback
4. **FF/SKIP**
goes to next chapter or track during playback; press and hold for 1.5 seconds for a forward search
5. **STOP**
to stop playback
6. **OPEN/CLOSE**
to open/close the disc tray
7. **Disc tray**
8. **Display**
9. **MAIN (AC Power Cord)**
connect to a standard AC outlet
10. **COAXIAL (Digital audio out)**
connect to AUDIO inputs of a digital (coaxial) audio equipment
11. **AUDIO OUT (Left/Right)**
connect to AUDIO inputs of an amplifier, receiver or stereo system
12. **VIDEO OUT**
connect to the Video Input of a TV.
13. **COMPONENT VIDEO OUT**
connect to a TV with Component video in jacks.
14. **S-VIDEO OUT**
connect to a TV with S-Video inputs
15. **INTERLACE/PROGRESSIVE SCAN SELECTOR**
to select interlace or progressive scanning (See page 5)

Caution: Do not touch the inner pins of the jacks on the rear panel. Electrostatic discharge may cause permanent damage to the player.

REMOTE CONTROL

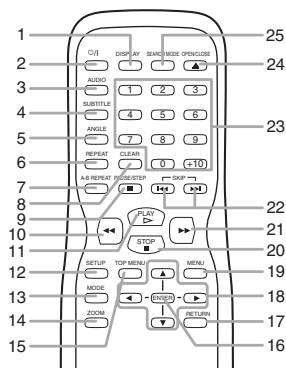

[Fig. 3]

1. **DISPLAY**
to access or remove the display screen during DVD or Audio CD playback
2. **⏻/⏻ (POWER/STANDBY)**
switch DVD player ON or OFF.
(As to the indication of the Operate switch, "I" indicates ON and "⏻" indicates electrical power STANDBY)
3. **AUDIO**
to choose audio languages or sound modes
4. **SUBTITLE**
subtitle language DVD selector
5. **ANGLE**
select DVD camera angle
6. **REPEAT**
repeat chapter, track, title, all.
7. **A-B REPEAT**
repeat a specific segment
8. **CLEAR**
to reset the setting
9. **PAUSE/STEP**
pause playback temporarily / frame-by-frame playback
10. **◀◀**
to view DVD picture in fast reverse motion
11. **PLAY**
to start a DVD disc playback
12. **SETUP**
to access or remove the DVD setup menu
13. **MODE**
to set up programmed or random playback (Audio CD)
to set the black level and virtual surround during DVD playback
14. **ZOOM**
enlarge DVD video image
15. **TOP MENU**
to display title menu of a disc
16. **ENTER**
acknowledge menu selection
17. **RETURN**
to return previous or remove setup menu
18. **Arrow (◀▶▲▼)**
(left/right/up/down) select an item in the menu
19. **MENU**
to display the menu of the DVD disc
20. **STOP**
to stop a DVD disc playback
21. **▶▶**
to view DVD picture in fast forward motion
22. **SKIP ◀◀▶▶**
to skip chapter/tracks
23. **0-9 numerical buttons**
select numbered items in a menu
+10
use this button to enter number 10 and above
24. **OPEN/CLOSE**
to open/close the disc tray
25. **SEARCH MODE**
to locate a desired point

FUNCTIONAL OVERVIEW

Display

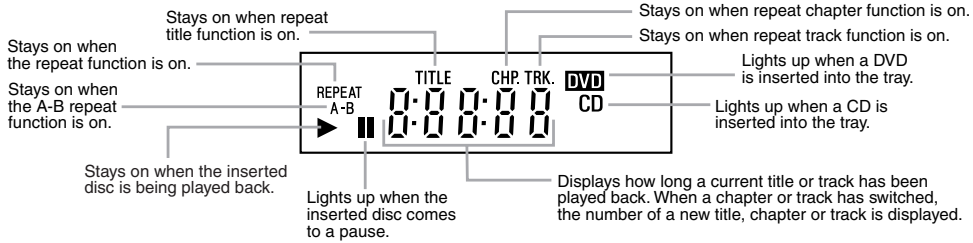

[Fig. 4]

Displays During Operation

| | |
|--|---------------------------------|
| | Power on |
| | No disc inserted / can not read |
| | Tray open |
| | Tray closed |
| | Loading the Disc |
| | Power off |
| | When a disc is being Play back |

Loading the Batteries

1. Open the battery compartment cover.
2. Insert two AA batteries, with each one oriented correctly.
3. Close the cover.

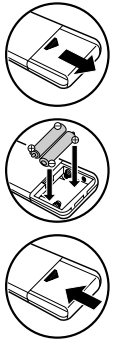

NOTES

- Do not mix alkaline and manganese batteries.
- Do not mix old and new batteries.

HOOK UPS

CAUTION:

- Be sure to turn off the Player and equipment to be connected before connecting.
- Read through the operation manual for the equipment to be connected.
- Be sure that the colors of the jacks and plugs match up when using VIDEO/AUDIO cables.
- Be sure to keep the Player connection cables separate from the TV antenna cable when you install the Player, because it may cause electrical interference when you are watching television programs.

Connecting to a TV using a VIDEO OUT Jack or a S-VIDEO OUT Jack

Use an S-Video cable (commercially available) in place of the yellow video cable to enjoy higher quality video.

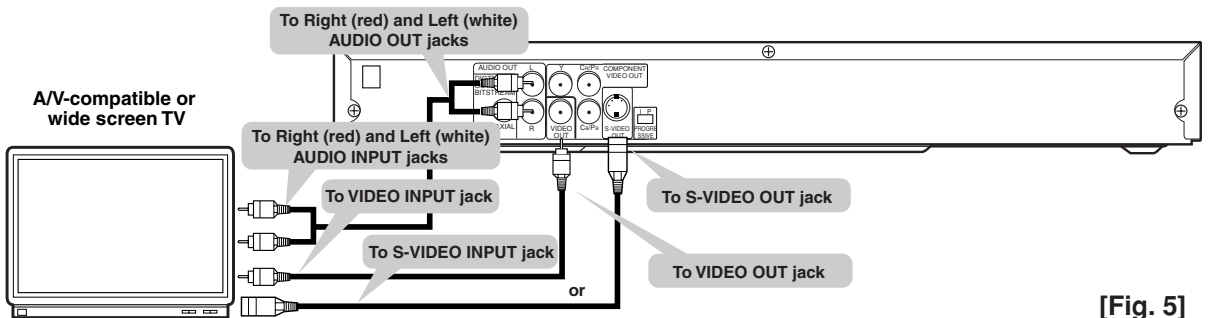

[Fig. 5]

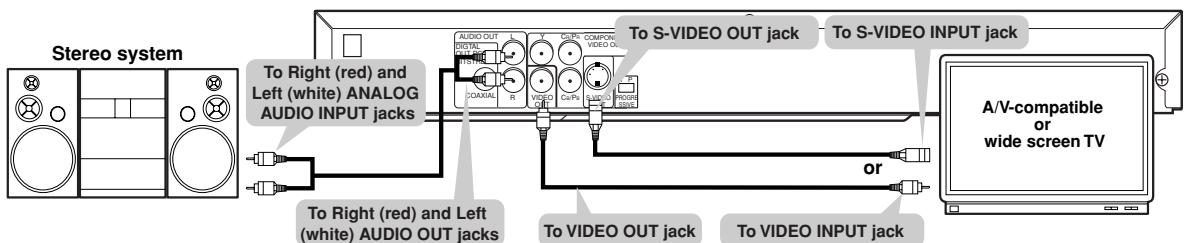

[Fig. 6]

NOTES:

- Connect the DVD player directly to a TV. If the A/V cables are connected to a VCR, pictures may be distorted due to the copy protection system.
- Be sure to turn off the power to all components in the system before connecting another component.
- Refer to the Owner's Manuals for your TV, stereo system and any other components to be connected to the DVD player.

Connecting to an Amplifier Equipped with Digital Input Jacks such as MD deck or DAT deck

Use an audio coaxial digital cables (commercially available) for the audio connections. Connecting to an amplifier equipped with digital input jacks such as MD Deck or Dat Deck.

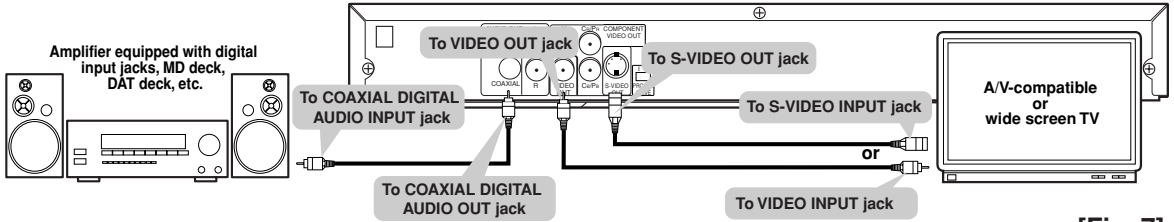

[Fig. 7]

NOTES:

- The audio source on a disc in a 5.1 channel Dolby Digital surround format cannot be recorded as digital sound by a MD or DAT deck.
- Set DOLBY DIGITAL to PCM for audio output in the setup mode. Playing a DVD using incorrect settings may generate noise distortion, and may also damage the speakers.(See page 13 to set BITSTREAM for DOLBY DIGITAL.)

Connecting to a Dolby Digital decoder

If using this DVD player to playback a DVD in a 5.1 channel Dolby Digital surround, the DVD player outputs a Dolby Digital data stream from its COAXIAL DIGITAL AUDIO OUT jack. By hooking the player up to a Dolby Digital decoder, you can enjoy a more convincing, realistic ambience with powerful and high-quality surround sound of a professional standard such as can be heard in movie theaters.

Use an audio coaxial digital cables (commercially available) for the audio connections.

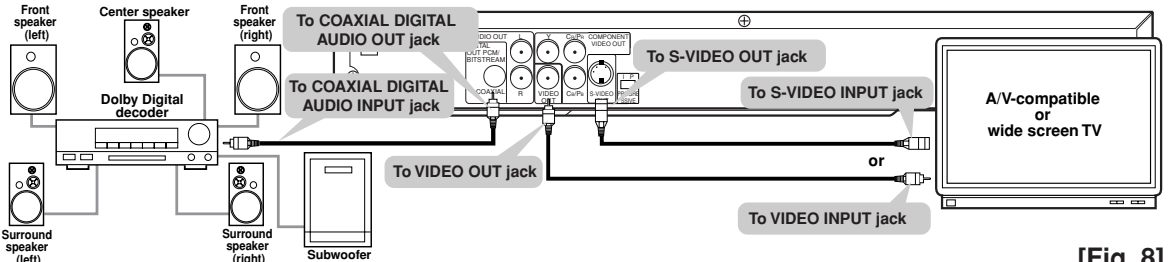

[Fig. 8]

NOTES:

- If output Dolby Digital audio, connect to a Dolby Digital decoder, and set DOLBY DIGITAL to BITSTREAM for audio output in the setup mode.
- Unless connected to a Dolby Digital decoder, set DOLBY DIGITAL to PCM for audio output in the setup mode. Playing a DVD using incorrect settings may generate noise distortion, and may also damage the speakers.

Connecting to a TV or a Stereo TV that has Component VIDEO In Jacks

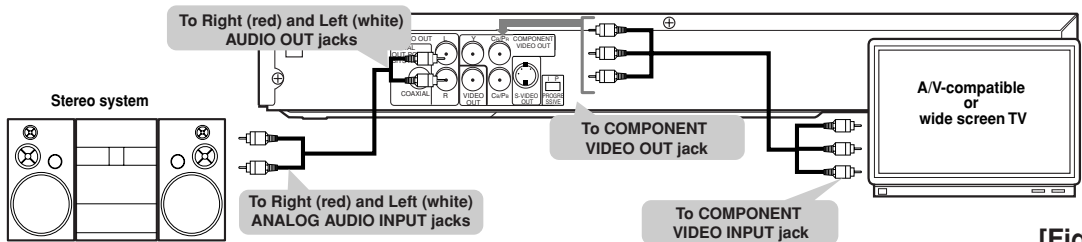

[Fig. 9]

NOTES:

- If your TV is compatible with progressive scanning (480p), connect the TV to the Component Video Output jacks of the DVD player, and make sure INTERLACE/PROGRESSIVE SCAN SELECTOR is set to P.

HOW TO CONNECT TO A TV WITHOUT AUDIO/VIDEO INPUT JACKS

If your TV does not have RCA type audio and video input jacks it is still possible to connect this DVD player to your TV's 75-ohm coaxial antenna terminal using a commercially available Stereo Audio/Video RF Modulator. Connect the audio and video outputs of the DVD player to the audio and video inputs on the RF Modulator, and then connect the coaxial output of the RF Modulator (usually marked "TO TV") to the 75 ohm coaxial antenna terminal on your TV. Follow the instruction supplied with the RF Modulator for more details. If your TV's 75 ohm coaxial antenna terminal is already occupied by an antenna or cable box connection, remove that cable from your TV's antenna terminal and reconnect it to the coaxial antenna input terminal of the RF Modulator (usually marked "ANT IN"), then connect the RF modulator to your TV's antenna terminal as described above.

NOTE

- The picture quality from DVD discs will not be as good if the DVD player is connected to the TV's antenna terminal through an RF Modulator.

Basic Playback

DVD CD

Getting started

- Turn on the power of the TV, amplifier and any other components which are connected to the DVD.
- Make sure the TV and audio receiver (commercially available) are set to the correct channel.

1 Press **⏻/⏮**.

- "P-ON" will appear briefly on the display panel.

2 Press **OPEN/CLOSE** to open disc loading tray.**3** Place the chosen disc in the tray, with the label facing up.**4** Press **PLAY**.

- The tray will close automatically, and playback will then start from the first chapter or track of the disc. If the playback does not start automatically, press **PLAY**.
- When you playback the DVD with a title menu recorded, it may appear on the screen. In this case, refer to "TITLE MENU".

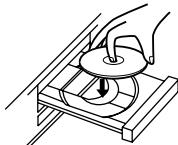
**5** Press **STOP** to stop playback.**NOTES:**

- A "prohibited icon" may appear at the top-right on the TV screen during operation, warning that a prohibited operation has been encountered by the DVD player or the disc.
- With DVDs that use some titles for playback program signals, playback may start from the second title, or it may skip these titles.
- During the playback of two layered disc, pictures may stop for a moment. This happens when the 1st layer switches to the 2nd layer. This is not a malfunction.



General Features

DVD may contain menus to navigate the disc and access special features. Press the appropriate numerical key or use **Arrow** (**▼/▲/▶/◀**) to highlight your selection in the DVD main menu and press **ENTER** to confirm.

NOTE:

- Unless stated, all operations described are based on remote control use. Some operations can be carried out using the menu bar on the TV screen.

Pause

DVD CD

1 During playback, press **PAUSE/STEP**.

- Playback will pause and sound will be muted.

2 To continue playback, press **PLAY**.

Disc Menus

DVD

1 Press **MENU**.

- The DVD main menu will appear.

2 If the feature is not available, **⊘** symbol may appear on the TV screen.**3** If disc menu is available on the disc, audio language, subtitle options, chapters for the title and other options will appear for selection.**4** Press **Arrow** (**▼/▲/▶/◀**) to select an item, and **ENTER** to confirm selection.

Title Menu

DVD

1 Press **TOP MENU**.

- The title menu will appear.

2 If the feature is not available, **⊘** symbol may appear on the TV screen.**3** Press **Arrow** (**▼/▲/▶/◀**) to select an item, and **ENTER** to confirm selection.

- Playback will begin at the selected Title.

CALLING UP A MENU SCREEN DURING PLAYBACK

DVD

- Press **MENU** to call up the DVD main menu.
- Press **TOP MENU** to call up the title menu.

NOTE:

- Contents of menus and corresponding menu operations may vary between discs. Refer to the manual accompanying the disc for details.

Step by Step Playback

DVD

1 During playback, press **PAUSE/STEP**.

- Playback will pause and sound will be muted.

2 The disc advances by one frame each time **PAUSE/STEP** is pressed.**3** To exit step by step playback, press **PLAY**.

Resume

DVD CD

1 During playback, press **STOP**.

- Resume message will appear on the TV screen.

2 Press **PLAY**, playback will resume from the point at which playback was stopped.

- To cancel resume, press **STOP** twice.

NOTE:

- The resume playback takes a little longer to take place compared to the normal playback.

Fast Forward / Reverse Search

DVD CD MP3

- During playback, press **▶▶** or **◀◀** repeatedly to select the required forward or reverse speed: x2, x8, x50, x100.
 - If you are using **SKIP ▶▶** / **SEARCH ▶▶** on the front panel, press and hold it for more than 1.5 sec (the longer you hold it, the faster the speed will be). When you reach the desired speed, release the button.
 - For audio CDs, the speed is fixed at x16.
 - For MP3, the speed is fixed at x8.
- To return to normal playback, press **PLAY**.

Slow Forward / Slow Reverse

DVD

- During playback, press **PAUSE/STEP**.
- Press **▶▶** or **◀◀**.
 - Slow motion playback will begin and sound will be muted.
- Press **▶▶** or **◀◀** repeatedly to select the required speed: 1/16, 1/8, 1/2 of the normal playback.
 - If you are using **SKIP ◀◀** / **SEARCH ◀◀** on the front panel, press and hold it for more than 1.5 sec (the longer you hold it, the slower the speed will be). When you reach the desired speed, release the button.
- To return to normal playback, press **PLAY**.

Zoom

DVD

The Zoom function allows you to enlarge the video image and to pan through the enlarged image.

- Press **ZOOM** during playback.
 - Playback will continue.
- Press **ZOOM** repeatedly to select the required zoom factor: x2, x4 or OFF.
- Use **Arrow** (**▼** / **▲** / **▶** / **◀**) to move the zoomed picture across the screen.
- To exit zoom mode, press **ZOOM** to OFF.

NOTES:

- Zooming function does not work while disc menu is shown.
- x4 zoom is not available on some discs.

Track

CD

There are three ways to begin playback on an Audio CD at a specific Track.

Using the Numerical buttons

- Press **numerical buttons** to enter the desired Track number.
 - Playback will start at the selected track.
 - For single digit tracks (1-9), press a single number (eg. track 3, press 3).
 - To play track 26, press +10, 2, 6 on the numerical button.

Using the SEARCH MODE

- Press **SEARCH MODE**.
 - The track search display appears.

- Within 30 seconds, select a desired track number using **numerical buttons**. For single digits press "0" first.
 - Playback will start at the selected track.

Using the SKIP ◀◀▶▶

- During playback, press **SKIP ▶▶** to move to the next track. Press it repeatedly to skip subsequent tracks. Press **SKIP ◀◀** to go back to the beginning of the current track. Press it repeatedly to go to the previous tracks.
- Track number will appear briefly on the DVD display panel.
 - If SKIP is pressed while the playback is paused, the playback will be paused again after skipping to the next track.

NOTE:

- SKIP ◀◀▶▶** are not available when playback is stopped.

Title / Chapter Search

DVD

- Press **SEARCH MODE** once for the Chapter search, twice for the Title search during playback.

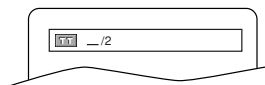

- Enter the desired chapter/title number using **numerical buttons**.

Time Search

DVD CD

- During playback, press **SEARCH MODE** three times (CD: twice) to display the Time Search on the TV screen.
- Within 30 seconds, enter a desired disc time using **numerical buttons**.
 - Playback will start at the specified time.
- Press **CLEAR** to erase the incorrect input.

Repeat

- REPEAT** is available only during playback.

REPEAT TITLE / CHAPTER

DVD

To activate the repeat function, press **REPEAT** during playback.

- The repeat mode changes as described below every time you press the button.

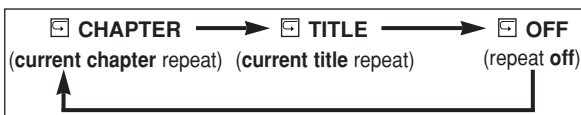

NOTES:

- Repeat Title/Chapter is not available with some scenes.
- The REPEAT setting will be cleared when moving to other title or chapter.

REPEAT TRACK

CD

To activate the repeat function, press **REPEAT** during playback.

- The repeat mode changes as described below every time you press the button.



NOTES:

- The REPEAT setting will be cleared when moving to other track.
- Repeat playback does not function during A-B repeat playback.

MP3

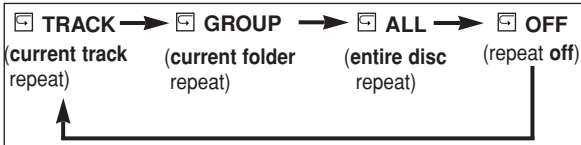

A-B REPEAT

DVD

CD

- Press **A-B REPEAT** at your chosen starting point.

- A** appears briefly on the TV screen.
- Press **A-B REPEAT** again at your chosen end point.
- A-B** appears briefly on the TV screen, and the repeat sequence begins.

- To exit the sequence, press **A-B REPEAT**.

NOTES:

- The A-B repeat section can only be set within the current title (for DVDs), or current track (for audio CDs).
- A-B Repeat is not available with some scenes in DVD.
- To cancel the A point which was set, press **CLEAR**.
- A-B Repeat playback does not function during title, chapter, track or all repeat playback.

Program

CD

You may determine the order in which tracks will play.

- In stop mode press **MODE**.

- The PROGRAM screen will appear.

- Press **▲** or **▼** to select a track, then press **ENTER**.

- Press **CLEAR** to erase the most recently entered program.

- Press **PLAY** to play the programmed tracks.

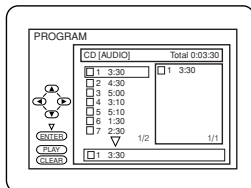

NOTES:

- While the program is being played back, the **STOP** works as follows.
- Press **STOP** once and then **PLAY** again, playback will restart from the point where **STOP** was pressed. (Program continued)
- Press **STOP** twice and then **PLAY** again, playback will restart from the track in the usual way. (Program cleared)
- Up to 99 programs can be entered.
- If you wish to repeat the current track in the program, press **REPEAT** repeatedly until **TRACK** appears during playback. If you wish to repeat the entire program press **REPEAT** repeatedly until **ALL** appears during playback.

Random Playback

CD

This shuffles the playing order of tracks instead of playback in the original sequence.

- In stop mode, press

MODE twice.

- RANDOM screen appears.

- Press **PLAY** to start random playback.

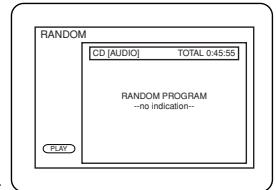

NOTES:

- If you wish to repeat the current track in the random selection, press **REPEAT** repeatedly until **TRACK** appears during playback. If you wish to repeat the entire random selection press **REPEAT** repeatedly until **ALL** appears during playback.

MP3 Playback

MP3

When a CD with MP3 files is inserted in the DVD player, the MP3 menu will appear on the TV screen, and number of tracks is displayed on the front panel.

- In stop mode, press **▲** or **▼** to select the desired group or track.

- If a group is selected, press **▶** or **ENTER** to go to the track selection screen.

Press **▲** or **▼** to choose a track, then press **PLAY** or **ENTER**.

- If a track is selected, press **PLAY** or **ENTER** to start playing tracks. Starting from the one you've just chosen the subsequent tracks will be played.

- Choose **FIRST PLAY** to start playback from the beginning of the listed tracks.

- Press **TOP MENU** to return to the first item.

- Press **STOP** to stop playback.

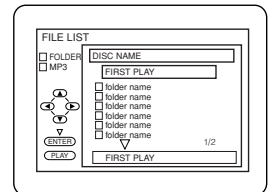

NOTES:

- Folders are known as Groups; files are known as Tracks.
- MP3 files are accompanied by **MP3** icon.
- Maximum of 255 folders can be recognized.
- Maximum of 256 files can be recognized.
- Up to 8 hierarchies can be created.

This player recommends the use of files recorded with the following specifications:

- Sampling frequency: 44.1kHz or 48kHz
- Constant bit rate: 112kbps ~ 320kbps.

On-Screen Information

MP3

You can check the MP3 files during playback.

- Press **DISPLAY**.

- The name of the file currently in play will be displayed.

- Press **DISPLAY** again to show the track number, the elapsed time, the repeat status, and the playback status at the top of the screen.

- T** will be displayed when the repeat play has been selected.

T - indicates Track repeat

G - indicates Group (folder) repeat

A - indicates Disc repeat

- Press **DISPLAY** again to exit.

Track Selection

MP3

- 1 Press **SEARCH MODE** during playback.
 - The FILE LIST will appear.
- 2 Select a desired track using **Arrow** (▼/▲/▶/◀).
 - Press ▶ when you want to go to the next hierarchy.
 - Press ◀ when you want to go back to the previous hierarchy.
- 3 Press **PLAY** to start playing

NOTES:

- Press **SEARCH MODE** to EXIT.
- Some selections may require additional time to be recognized.

Random Playback

MP3

- 1 Press **MODE** twice while playback is stopped.
- 2 Press **PLAY** to play the tracks in random order.

Program

MP3

This feature allows you to program a mp3 disc to play in a desired sequence.

- 1 Press **MODE** while playback is stopped.
 - The PROGRAM screen will appear.
- 2 Press ▲ or ▼ to select a track, then press **ENTER**, to save it in a program.
 - Press **CLEAR** to erase the incorrect input.
- 3 Press **PLAY** to start programmed playback.

Audio Language

DVD

The DVD player allows you to select a language during DVD disc (if multi language available) playback.

- 1 Press **AUDIO** during playback.
- 2 Press **AUDIO** repeatedly to select your desired language.

Stereo Sound Mode

CD

- 1 Press **AUDIO** repeatedly during playback to select between STEREO, L-CH or R-CH.

STEREO - both right and left channels are active (stereo)

L-CH - only left channel is active

R-CH - only right channel is active

NOTE:

- If the Virtual Surround setting is ON, the sound mode will be fixed to STEREO, and can not be changed.

Subtitle Language

DVD

The DVD player allows you to select a language for subtitle during DVD disc (if available) playback.

- 1 Press **SUBTITLE** during playback.
- 2 Press **SUBTITLE** repeatedly to select your desired subtitle language.
 - The selected language will be displayed on the display bar at the top of the screen.
- 3 To turn off subtitles, press **SUBTITLE** repeatedly until OFF appears.

NOTES:

- Pressing **AUDIO** may not work on some DVDs with multiple audio languages (e.g. DVDs which allow audio language setting on the disc menu).
- Some discs allow audio language setting/subtitle language setting on the disc menu. (Operation varies between discs, so refer to the manual accompanying the disc.)
- If the desired language is not shown after pressing **SUBTITLE** several times, the disc does not have subtitles in that language.
- If you choose a Language that has a 3 letter language code, the code will be displayed every time you change the Subtitle language setting. If you choose any other languages, '---' will be displayed instead. (Refer to page 14.)

Camera Angle

DVD

Some DVD discs contain scenes which have been shot simultaneously from various angles. You can change the camera angle when the (CAM) mark appears on the screen.

- 1 Press **ANGLE** during playback.
 - The selected angle will be displayed on the display bar at the top of the screen.
- 2 Press **ANGLE** repeatedly to select your desired angle.

Changing the On-Screen Display

DVD

You can check information about the current disc by pressing **DISPLAY** on the remote control.

- 1 Press **DISPLAY** during playback to show current Chapter.
 - The elapsed and remaining playing time of the current chapter will be displayed.
- 2 Press **DISPLAY** again to show current Title.
 - The elapsed and remaining playing time of the current title will be displayed.
- 3 Press **DISPLAY** the third time.
 - The BIT RATE and the current repeat setting will be displayed.
 - If you are playing a dual layered disc, the layer number will also be displayed (L0: Layer 0 is playing. L1: Layer 1 is playing).
- 4 Press **DISPLAY** the fourth time to remove the display.

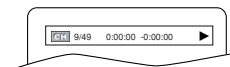

CD

- 1 Press **DISPLAY** during playback, the current Track will be displayed on the TV screen.
 - The elapsed and remaining playing time of the current track will be displayed.
- 2 Press **DISPLAY** again to show current Total Track.
 - The elapsed and remaining playing time of the current total track will be displayed.
- 3 Press **DISPLAY** the third time to remove the display.

PLAYING A DISC

Parental Control

DVD

Parental Control limits playback of discs with unsuitable audience ratings. A four digit code established by the user will unlock the parental lock.

This feature allows you to prevent discs with objectionable scenes from being played by your children.

PARENTAL LEVEL

Parental Level allows you to set the rating level of your DVD discs. Playback will stop if the disc's ratings exceed the level you set.

- 1 Press **SETUP** in STOP mode.
- 2 Press **▶** to select **CUSTOM**, then press **ENTER**.
- 3 Press **◀** or **▶** to select **PARENTAL**, then press **ENTER**.
- 4 Enter your four-digit password then press **ENTER**.
- 5 Press **▲** or **▼** to select **PARENTAL LEVEL**, then press **ENTER**.
- 6 Press **▲** or **▼** to select the desired level.
- 7 Press **SETUP** to exit.

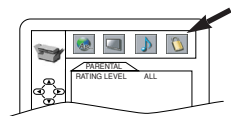

NOTES:

- When doing this for the first time, enter any 4 digits. (except for 4737) That number will be used as the password from the second time onward.
- To change the password, press **▲** or **▼** to select **CHANGE**, then press **ENTER**. Enter the four-digit pass-word, then press **ENTER**.
- With some DVDs, it may be difficult to find if they are compatible with parental lock. Be sure to check if the parental lock function operates in the way that you have set.
- Record the password in case you forget it.

IF YOU FORGET THE PASSWORD

- 1 Press **4, 7, 3, 7** at step 4.
 - Password will be cleared and parental level will be set to **ALL**.
- 2 Repeat steps 5-7 to re-establish the parental lock.

DVD SETUP

Audio Setting

Choose the appropriate Audio settings for your equipment as it only affect during the playback of DVD discs of the DVD player.

- 1 In STOP mode press **SETUP**.
- 2 Press **▶** to select **CUSTOM**, then press **ENTER**.
 - **CUSTOM** mode will appear.
- 3 Press **◀** or **▶** to select **AUDIO**, then **ENTER** to confirm.
- 4 Press **▲** or **▼** to select the below items, then press **ENTER**.

DRC (Dynamic Range Control) :

- To compress the range of sound volume.
- The default setting is **OFF**.

DOLBY DIGITAL : **QUICK**

Set to **BITSTREAM** when the player is connected to Dolby Digital Decoder.

(**BITSTREAM** : Output by Dolby Digital)

(**PCM** : Convert the Dolby Digital to PCM)

- The default setting is **BITSTREAM**.

DOWN SAMPLING :

- Set to **ON** when outputting in 48kHz.
- The default setting is **ON**.

When playing disc with copyright Protection

- If you select **OFF**, copyright protection will be activated and sound will be down sampled at 48kHz.

- 5 Press **SETUP** to exit.

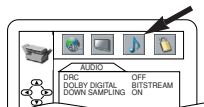

CONTROL LEVELS

- **ALL**
 - Parental lock is cancelled.
- **Level 8**
 - DVD software of any grade (adult/general/children) can be played back.
- **Levels 7 to 2**
 - Only DVD software intended for general use and children can be played back.
- **Level 1**
 - Only DVD software intended for children can be played back, with those intended for adult and general use prohibited.

Marker Setup Screen

DVD

CD

Use markers to memorise your favourite places on a disc.

- 1 Press **SEARCH MODE** four times (CD: three times) during playback.
 - The display screen and Markers will appear on the TV screen.
- 2 Press **◀** or **▶** to select 1, 2, 3, 4, 5, 6, 7, 8, 9, or 10 and ensure that "- : - : -" appears in the display.
- 3 When reaches the desired point, press **ENTER**.
 - The Title or Track and elapsed playing time will appear in the TV screen.
- 4 To return to the Marker later, press **SEARCH MODE** four times (CD: three times) during playback and **◀** or **▶** to choose the desired marker, then press **ENTER**.

NOTES:

- Opening the disc tray or turning off the power or select **AC** at step 2 and press **ENTER** will erase all Markers.
- To clear a marker, using **◀** or **▶**, position the cursor on to the marker number to be cleared and press **CLEAR**.
- You can mark up to 10 points.

- 5 Press **SEARCH MODE** or **RETURN** to exit.

Black Level Setting

DVD

Adjust the Black Level Settings to make the black parts of the picture as bright as you preferred.

- 1 Press **MODE** during playback.
- 2 Press **ENTER** to switch **ON/OFF**.
 - ON** : Makes the dark parts brighter.
 - OFF** : Shows the original picture as recorded.
- 3 Press **MODE** twice or **RETURN** to exit.

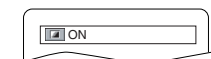

Virtual Surround

You can enjoy stereophonic visual space on your existing 2 channel stereo system.

DVD

CD

MP3

- 1 Press **MODE** twice (CD/MP3: once) during playback.

- 2 Press **ENTER** to set it 1(Natural effect), 2(Emphasized effect) or **OFF**.
- 3 Press **MODE** or **RETURN** to exit.

NOTE (for CD play only):

- Virtual Surround will not be effective if the sound mode is set to something other than **STEREO**.

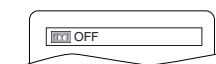

Display Setting

DVD

You can change certain aspects of the DVD display screens, on-screen messages and the display panel on the front of the DVD player.

- 1 Press **SETUP** in STOP mode.
- 2 Press **▶** to select **CUSTOM**, then press **ENTER**.
 - CUSTOM mode will appear.
- 3 Press **◀** or **▶** to select **DISPLAY**, then **ENTER** to confirm.
- 4 Press **▲** or **▼** to select the below items, then press **ENTER**.

TV ASPECT : **QUICK**

- Press **▲** or **▼** for an item selection, then press **ENTER**.
- Select 4:3 LETTER BOX for a black bars appears on top and bottom of the screen.
- Select 4:3 PAN - SCAN for a full height picture with both sides trimmed.
- Select 16:9 WIDE if a wide-screen TV is connected to the DVD player.
- The default setting is 4:3 LETTER BOX.

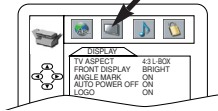

FRONT DISPLAY :

- Press **▲** or **▼** for an item select BRIGHT, DIM and AUTO DIM, then press **ENTER**.
- This adjust the brightness of the display panel with the factory default BRIGHT.
- When AUTO DIM is selected, the display dims only during playback.

ANGLE MARK :

- Press **ENTER** repeatedly to turn Angle mark ON or OFF.
- The default setting is ON.

AUTO POWER OFF :

- Press **ENTER** repeatedly to turn Auto Power ON or OFF.
- The default setting is ON and it will turn the DVD player to off automatically after 35 minutes of no use.

LOGO :

- Press **ENTER** to switch ON (opening picture)/OFF(black).
- The default setting is ON.

1 Press **SETUP** to exit.

NOTES:

- Be sure to press the SETUP button, or the setting will not work.
- You can also choose the item by pressing the numbers.

Language Setting

DVD

Language options are not available with some discs.

- 1 Press **SETUP** in STOP mode.
- 2 Press **▶** to select **CUSTOM**, then press **ENTER**.
 - CUSTOM mode will appear.
- 3 Press **◀** or **▶** to select **LANGUAGE**, then **ENTER** to confirm.
- 4 Press **▲** or **▼** to select the below items, then press **ENTER**.

AUDIO :

- Sets the audio language.

SUBTITLE :

- Sets the subtitle language.

DISC MENU :

- Sets the language for DVD Menu.

PLAYER MENU : **QUICK**

- Sets the language for the On-Screen display.

5 Press **▲** or **▼** to select a setting, then press **ENTER**.

- If OTHERS is selected in the AUDIO, SUBTITLE or DISC MENU screen, press four-digit number to enter the code for the desired language. (Refer to the language code list below).
- Only the languages supported by the disc can be selected.

6 Press **SETUP** to exit.

NOTE:

- Language Setting for Audio and Subtitle is not available with some discs. Then use **AUDIO** and **SUBTITLE**. Details are on pages 12.

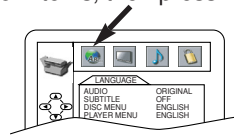

| Language | Code | Language | Code | Language | Code | Language | Code |
|----------------|------|-----------------|------|------------------|------|---------------|------|
| Abkhazian | A-B | Frisian | 5271 | Malay | 5965 | Somali | 6561 |
| Afar | 4748 | Galician | 5358 | Malayalam | 5958 | Spanish [SPA] | 5165 |
| Afrikaans | 4747 | Georgian | 5747 | Maltese | 5966 | Sundanese | 6567 |
| Albanian | 4752 | German [GER] | 5051 | Maori | 5955 | Swahili | 6569 |
| Amharic | 6563 | Greek [GRE] | 5158 | Marathi | 5964 | Swedish [SWE] | 6568 |
| Arabic | 4759 | Greenlandic | 5758 | Moldavian | 5961 | | T |
| Armenian | 4764 | Guarani | 5360 | Mongolian | 5960 | Tagalog | 6658 |
| Assamese | 5471 | Gujarati | 5367 | Nauru | 6047 | Tajik | 6653 |
| Aymara | 4765 | Hausa | 5447 | Nepali | 6051 | Tamil | 6647 |
| Azerbaijani | 4771 | Hebrew | 5569 | Norwegian [NOR] | 6061 | Tatar | 6666 |
| Bashkir | 4772 | Hindi | 5455 | | O-R | Telugu | 6651 |
| Basque | 4847 | Hungarian [HUN] | 5467 | Occitan | 6149 | Thai | 6654 |
| Bengali;Bangla | 5167 | | I-K | Oriya | 6164 | Tibetan | 4861 |
| Bhutani | 4860 | Icelandic [ICE] | 5565 | Oromo(Afan) | 6159 | Tigrinya | 6655 |
| Bihari | 5072 | Indonesian | 5560 | Panjabi | 6247 | Tonga | 6661 |
| Bislama | 4854 | Interlingua | 5547 | Pashto;Pushto | 6265 | Tsonga | 6665 |
| Breton | 4855 | Interlingue | 5551 | Persian | 5247 | Turkish [TUR] | 6664 |
| Bulgarian | 4864 | Inupiak | 5557 | Polish | 6258 | Turkmen | 6657 |
| Burmese | 4853 | Irish [IRI] | 5347 | Portuguese [POR] | 6266 | Twi | 6669 |
| Byelorussian | 5971 | Italian [ITA] | 5566 | Quechua | 6367 | | U-Z |
| | 4851 | Japanese [JPN] | 5647 | Rhaeto-Romance | 6459 | Ukrainian | 6757 |
| | C-E | Javanese | 5669 | Romanian [RUM] | 6461 | Urdu | 6764 |
| Cambodian | 5759 | Kannada | 5760 | Russian [RUS] | 6467 | Uzbek | 6772 |
| Catalan | 4947 | Kashmiri | 5765 | | S | Vietnamese | 6855 |
| Chinese [CHI] | 7254 | Kazakh | 5757 | Samoan | 6559 | Volapuk | 6861 |
| Corsican | 4961 | Kinyarwanda | 6469 | Sangho | 6553 | Welsh | 4971 |
| Croatian | 5464 | Kirghiz | 5771 | Sanskrit | 6547 | Wolof | 6961 |
| Czech | 4965 | Kirundi | 6460 | Scots Gaelic | 5350 | Xhosa | 7054 |
| Danish [DAN] | 5047 | Korean [KOR] | 5761 | Serbian | 6564 | Yiddish | 5655 |
| Dutch [DUT] | 6058 | Kurdish | 5767 | Serbo-Croatian | 6554 | Yoruba | 7161 |
| English [ENG] | 5160 | | L-N | Sesotho | 6566 | Zulu | 7267 |
| Esperanto | 5161 | Laothian | 5861 | Setswana | 6660 | | |
| Estonian | 5166 | Latin | 5847 | Shona | 6560 | | |
| | F-H | Latvian;Lettish | 5868 | Sindhi | 6550 | | |
| Faroese | 5261 | Lingala | 5860 | Singhalese | 6555 | | |
| Fiji | 5256 | Lithuanian | 5866 | Siswat | 6565 | | |
| Finnish [FIN] | 5255 | Macedonian | 5957 | Slovak | 6557 | | |
| French [FRE] | 5264 | Madagasy | 5953 | Slovenian | 6558 | | |

If you choose a Language that has a 3 letter language code, the code will be displayed every time you change the Audio or Subtitle language setting on page 12. If you choose any other languages, '---' will be displayed instead. (3 letter language code is written in bracket.)

TROUBLESHOOTING GUIDE

If the DVD player does not perform properly when operated as instructed in this Owner's Manual, check the player, consulting the following checklist.

| Problem | Solution |
|--|--|
| No power | <ul style="list-style-type: none"> -Check if the AC power cord is properly connected. -Unplug the outlet once, and wait for 5-10seconds and then plug it in again |
| No sound or picture | <ul style="list-style-type: none"> -Check if the TV is switched on. -Check the video connection -Check the VIDEO/AUDIO cable connections to the TV (See Connecting to a TV) -Check if the INTERLACE/PROGRESSIVE SCAN SELECTOR is set correctly according to your TV. |
| Distorted picture | <ul style="list-style-type: none"> -Sometimes a small amount of picture distortion may appear. This is not a malfunction. -Connect the player directly to th TV. |
| Completely distorted picture or black/white picture with DVD | <ul style="list-style-type: none"> -Connect DVD player directly to the TV. |
| No sound or distorted sound | <ul style="list-style-type: none"> -Make sure the disc is compatible with the DVD player. -Adjust the volume. -Check that the speakers are connected correctly. |
| No audio at digital output | <ul style="list-style-type: none"> -Check the digital connections. -Check if the audio format of the selected audio language matches your receiver capabilities. |
| No DTS audio output | <ul style="list-style-type: none"> -This player does not support DTS audio. This is not a malfunction. |
| Picture freezes momentarily during playback | <ul style="list-style-type: none"> -Check the disc for fingerprints/scratches and clean with a soft cloth wiping from center to edge. -Clean the disc |
| Disc can't be played | <ul style="list-style-type: none"> -Clean the disc -Ensure the disc label is facing up. -Check if the disc is defective by trying another disc. -Cancel the parental lock or change the control level. -Insert a correct disc that paly on this player. |
| No return to start-up screen when disc is removed | <ul style="list-style-type: none"> -Reset the player by switching the player off, then on again. |
| The player does not respond to the remote control | <ul style="list-style-type: none"> -Aim the remote control directly at the sensor on the front of the player. -Reduce the distance to the player. -Replace the batteries in the remote control. -Re-insert the batteries with their polarities (+/- signs) as indicated. |
| Buttons do not work or player stops responding | <ul style="list-style-type: none"> -To completely reset the player, unplug the AC cord from the AC outlet for 5-10 seconds. |
| Player does not respond to some operating commands during playback. | <ul style="list-style-type: none"> -Operations may not be permitted by the disc. Refer to the instructions of the disc. |
| DVD player cannot read CDs/DVDs | <ul style="list-style-type: none"> -Use a commonly available cleaning CD/DVD to clean the lens before sending the DVD player for repair. |

NOTES:

Some functions are not available in specific modes, but this is not a malfunction. Read the description in this Owner's Manual for details on correct operations.

- Playback from a desired track and random playback are not available during program playback.

SPECIFICATIONS

OUTPUT SIGNAL FORMAT

NTSC color

POWER SOURCE

120 V AC +/- 10%, 60 Hz +/- 0.5%

POWER CONSUMPTION

11 W (standby: 3.9W)

OPERATING TEMPERATURE

41°F(5°C) to 104°F(40°C)

DIMENSIONS

W 17-1/8" (435mm)

H 2-1/4" (55mm)

D 8-1/4" (211mm)

WEIGHT

Approx 3.8lbs (1.8kg)

- Designs and specifications are subject to change without notice.
- If there is a discrepancy between languages, the default language will be English.

MAINTENANCE

Servicing

- Should your DVD player become inoperative, do not try to correct the problem by yourself. There are no user-serviceable parts inside. Turn off, unplug the power cord, and please call our help line at 1-800-448-2244 (1-800-HITACHI), to locate an Authorized Service Center.

Cleaning the Cabinet

- Use a soft cloth slightly moistened with a mild detergent solution. Do not use a solution containing alcohol, spirits, ammonia or abrasives.

Cleaning Discs

- When a disc becomes dirty, clean it with a cleaning cloth. Wipe the disc from the center out. Do not wipe in a circular motion.
- Do not use solvents such as benzine, thinner, commercially available cleaners, detergent, abrasive cleaning agents or antistatic spray intended for analogue records.

Cleaning the disc lens

- If the player still does not perform properly when it is operated while referring to the relevant sections and to "TROUBLESHOOTING GUIDE" in this Owner's Manual, the laser optical pickup unit may be dirty. Consult your dealer or an Authorized Service Center for inspection and cleaning of the laser optical pickup unit.

Disc Handling

- Use discs which have the following logos on them. (Optical audio digital discs.)
- Handle the discs so that fingerprints and dust do not adhere to the surfaces of the discs.
- Always store the disc in its protective case when it is not used.



Make your contribution to the environment!!!

- Used up batteries do not belong in the dust bin.
- You can dispose of them at a collection point for used up batteries or special waste. Contact your council for details.



CONTROLES DE OPERACIÓN Y FUNCIONES

PANEL DELANTERO / VISTA TRASERA

Consulte la figura 1, 2 da la página 6.

- 1. \odot/I (Botón de la alimentación) (POWER)**
Púlselo para conectar y desconectar la alimentación. (Para las indicaciones del interruptor de funcionamiento, "I" indica la conexión y " \odot/I " indica el estado de espera de alimentación eléctrica.)
- 2. Botón de SKIP/FR**
Púlselo para volver al capítulo o pista anterior durante la reproducción; manténgalo pulsado durante 1,5 segundos para hacer la búsqueda en retroceso.
- 3. Botón de reproducción (PLAY)**
Inicie la reproducción del contenido del disco.
- 4. Botón de FF/SKIP**
Púlselo para avanzar al capítulo o pista siguiente durante la reproducción; manténgalo pulsado durante 1,5 segundos para hacer la búsqueda hacia adelante.
- 5. Botón de parada (STOP)**
Detiene la operación del disco.
- 6. Botón de apertura/cierre (OPEN/CLOSE)**
Púlselo para introducir discos en la bandeja o sacarlos de ella.
- 7. Bandeja de disco (Disc tray)**
- 8. Botón de la alimentación (Display)**
- 9. Cable de alimentación (AC Power Cord)**
Conecte a una toma de alimentación.
- 10. Toma de salida de audio digital coaxial (Digital audio out)**
- 11. Toma de salida de audio (AUDIO OUT Left/Right)**
- 12. Toma de salida de vídeo (VIDEO OUT)**
- 13. Toma de salida de vídeo componente (COMPONENT VIDEO OUT)**
- 14. Toma de salida de vídeo S (S-VIDEO OUT)**
- 15. Selector de exploración entrelazada/progresiva (INTERLACE/PROGRESSIVE SCAN SELECTOR)**
Para seleccionar la exploración entrelazada o progresiva.

MANDO A DISTANCIA

Consulte la figura 3 da la página 6.

- 1. Botón de visualización (DISPLAY)**
Muestra el estado actual en la pantalla del televisor con fines de comprobación.
- 2. \odot/I (Botón de la alimentación) (POWER)**
Púlselo para conectar y desconectar la alimentación. (Para las indicaciones del interruptor de funcionamiento, "I" indica la conexión y " \odot/I " indica el estado de espera de alimentación eléctrica.)
- 3. Botón de AUDIO**
Púlselo para seleccionar el modo de sonido o el idioma de audio deseado.
- 4. Botón de subtítulos (SUBTITLE)**
Púlselo para seleccionar el idioma de subtítulos deseado.
- 5. Botón de ángulos (ANGLE)**
Púlselo para cambiar el ángulo de la cámara y ver desde un ángulo diferente la secuencia que está siendo reproducida.
- 6. Botón de repetición (REPEAT)**
Repite la reproducción del disco, título, capítulo o pista actual.
- 7. Botón de repetición A-B (A-B REPEAT)**
Repite la reproducción de una sección seleccionada.
- 8. Botón de cancelación (CLEAR)**
Repone un ajuste.
- 9. Botón de pausa (PAUSE/STEP)**
Hace una pausa en la operación del disco actual.
- 10. \blacktriangleleft**
Hace que la reproducción retroceda rápidamente hasta un punto deseado.
- 11. Botón de reproducción (PLAY)**
Inicie la reproducción del contenido del disco.
- 12. Botón de preparación (SETUP)**
Púlselo para entrar en el modo de preparación o para cambiar elementos de preparación.
- 13. Botón de modo (MODE)**
Activa el modo de reproducción programada o el modo de reproducción aleatoria. Para fijar conexión/desconexión de nivel negro y de virtual rodee.
- 14. Botón del ZOOM**
Amplia parte de una imagen de DVD reproducida.
- 15. Botón de titulación (TOP MENU)**
Visualiza el menú de títulos.
- 16. Botón de introducción (ENTER)**
Púlselo para aceptar un ajuste.
- 17. Botón de retorno (RETURN)**
Púlselo para volver a la operación anterior.
- 18. Botones de flechas (\blacktriangleleft \blacktriangleright \blacktriangle \blacktriangledown)**
Utilícelos cuando haga ajustes mientras ve la visualización en una pantalla de televisión.
- 19. Botón de MENU Visualiza los menús DVD.**
- 20. Botón de parada (STOP)**
Detiene la operación del disco.

CONTROLES DE OPERACIÓN Y FUNCIONES

21. ►►

Hace que la reproducción avance rápidamente hasta un punto deseado.

22. Botones SKIP ◀◀▶▶

Presione para saltar capítulos o pistas.

23. 0-9 Botones numéricos

select numbered items in a menu

Selección de Exploración Progresiva (480p o Reproducción Entrelazada 480i)

● Si su TV es compatible con exploración progresiva (480p), conecte el TV a las tomas de Salida de Vídeo Componente del reproductor DVD y ponga el INTERLACE/PROGRESSIVE SCAN SELECTOR de la parte posterior del reproductor DVD en P (PROGRESSIVE). A continuación, ajuste su TV al modo de exploración progresiva. Si su TV no es compatible con exploración progresiva, mantenga el INTERLACE/PROGRESSIVE SCAN SELECTOR en I (INTERLACE).

- Utilice un adaptador disponible en el mercado si las tomas de entrada de vídeo de TV o monitor son del tipo BNC.
- Si usted cambia entre PROGRESSIVE/INTERLACE cuando está conectada la alimentación, el reproductor DVD se apagará automáticamente. Cuando vuelva a encender el reproductor DVD, se empleará el último sistema de escaneo seleccionado.

¿Qué es Exploración Progresiva?

- Distinto de exploración entrelazada convencional, el sistema de exploración progresiva de reproductor DVD provee menos imágenes oscilantes en resolución superior que la de señales de televisión tradicional (480i).
- Cuando se seleccione P (PROGRESSIVE), no saldrán señales de vídeo por la toma VIDEO OUT o S-VIDEO OUT.

Visualización



Visualizaciones Durante la Operación

| | | | |
|--|---|--|---------------------------------------|
| | Conexión de alimentación | | Carga del disco |
| | No hay disco colocado / no puede leerlo | | Desconexión de alimentación |
| | Bandeja abierta | | Quando se está reproduciendo un disco |
| | Bandeja cerrada | | |

Instalación de las Pilas

1. Abra la tapa del compartimento de las pilas.
2. Introduzca dos pilas AA con las polaridades colocadas correctamente.
3. Cierre la tapa.

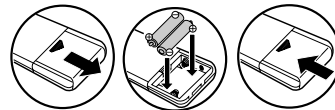

NOTAS

- No mezcle pilas alcalinas y de manganeso.
- No mezcle pilas viejas y nuevas.

CONEXIONES

Conexión a un Televisor

Utilice un cable de vídeo S (de venta en el comercio) en lugar del cable de vídeo amarillo para disfrutar de imágenes de más alta calidad. Consulte la figura 5 de la página 7 / Consulte la figura 6 de la página 7

Conexión a un Amplificador Equipado con tomas de Entrada Digital, Platina MD o Platina DAT

Para hacer las conexiones de audio utilice cables digitales coaxiales de audio (de venta en el comercio). Consulte la figura 7 de la página 8

Conexión a un Decodificador Dolby Digital

Si utiliza este reproductor DVD para reproducir un DVD en un formato de sonido ambiental Dolby Digital de 5,1 canales, el reproductor DVD dará salida a un flujo de datos Dolby Digital desde su toma COAXIAL DIGITAL AUDIO OUT. Conectando el reproductor a un decodificador Dolby Digital, usted podrá disfrutar de un ambiente más convincente y real, con un sonido ambiental potente y de alta calidad de estándar profesional como el que puede oírse en los cines.

Para hacer las conexiones de audio utilice cables digitales coaxiales de audio (de venta en el comercio). Consulte la figura 8 de la página 8

CONEXIONES

Conexión a un Televisor o a un Televisor Estéreo Que tenga tomas Component Video in

Consulte la figura 9 de la página 8

REPRODUCCIÓN DE UN DISCO

Reproducción de un DVD de Vídeo o un CD de Audio

DVD CD

Para empezar

Conecte la alimentación del televisor, amplificador y cualquier otro componente que esté conectado al reproductor DVD. (Cambie el sistema de entrada para adaptarlo al reproductor DVD, y compruebe que el volumen del sonido sea correcto.)

- 1** Pulse el botón \odot/I .
 - La alimentación se conectará.
- 2** Pulse el botón **OPEN/CLOSE**.
 - La bandeja de carga del disco se abrirá.
- 3** Ponga un disco en la bandeja.
 - Asegúrese de que el disco esté correctamente asentado en el hueco correcto, con el lado de la etiqueta hacia arriba.
- 4** Pulse el botón **PLAY**.
 - La bandeja se cerrará automáticamente y la reproducción empezará desde el primer capítulo o pista del disco. Necesitará pulsar el botón **PLAY** sólo cuando la bandeja haya sido cerrada pulsando el botón **OPEN/CLOSE**.
 - Cuando reproduzca un DVD que tenga grabado un menú de títulos, el menú tal vez aparezca en la pantalla.
- 5** Pulse el botón **STOP** para detener la reproducción.

HITACHI

*service
hotline*

To locate an authorized
HITACHI service facility in
the continental U.S.A

DIAL TOLL FREE
7 days a week, 24 hours a day

800 HITACHI

1-800-448-2244

Hitachi has made every effort to assure you hours of trouble free operation from your unit . However , should you require service , a network of Hitachi Authorized Service Facilities has been established in all 50 states and Puerto Rico . Each facility will provide you with convenient and expedient assistance . Our service "Hot line" operator will direct you to the Hitachi Authorized Service Facility nearest you . Just present proof of purchase and/or delivery receipts to the Hitachi Authorized Service Facility and service will be rendered in accordance with the terms of the limited warranty as stated on your warranty card or operating guide .

Should you have any questions regarding in-warranty service, operation or technical assistance, please contact:

HITACHI AMERICA, LTD.
HOME ELECTRONICS DIVISION
1855 Dornoch Court,
San Diego, California 92154-7255,
Tel: 1-800-HITACHI
(1-800-448-2244)

during the business hours

Monday - Friday EST 9:00am~7:00pm
Saturday EST 9:00am~5:00pm

HITACHI CANADA LTD .
DIGITAL MEDIA DIVISION

6740 Campobello Road, Mississauga,
Ontario L5N 2L8 CANADA
Tel: 1-800-HITACHI
(1-800-448-2244)

durant les heures de bureau:

Lundi au Vendredi 9:00am~7:00pm (h.n.e.)
Samedi 9:00am~5:00pm (h.n.e.)