



Slim Progressive Scan  
DVD Player

SKU 319618

User's Guide

**Important notice: Please read this manual carefully**

All brand names and trademarks are the property of their respective owners

## WARNING

- TO PREVENT FIRE OR SHOCK HAZARD. DO NOT USE THIS PLUG WITH AN EXTENSION CORD. RECEPTACLE OR OTHER OUTLET UNLESS THE BLADES CAN BE FULLY INSERTED TO PREVENT BLADE EXPOSURE.

- TO REDUCE THE RISK OF FIRE OR ELECTRIC SHOCK, DO NOT EXPOSE THIS APPLIANCE TO RAIN OR MOISTURE.

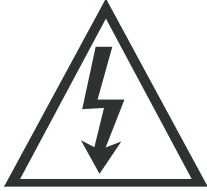

The lightning flash with arrowhead symbol, within an equilateral triangle, is intended to alert the user to the presence of uninsulated "dangerous voltage" within the product's enclosure that may be of sufficient magnitude to constitute a risk of electric shock to persons.

**CAUTION**  
**RISK OF ELECTRIC SHOCK**  
**DO NOT OPEN**

CAUTION: TO REDUCE THE RISK OF ELECTRIC SHOCK, DO NOT REMOVE COVER (OR BACK) NO USER SERVICEABLE PARTS INSIDE. REFER SERVICING TO QUALIFIED SERVICE PERSONNEL.



The exclamation point within an equilateral triangle is intended to alert the user to the presence of important operating and maintenance (servicing) instructions in the literature accompanying the appliance.

## IMPORTANT SAFETY INSTRUCTIONS

- 1) Read these instructions.
- 2) Keep these instructions.
- 3) Heed all warnings.
- 4) Follow all instructions.
- 5) Do not use this apparatus near water.
- 6) Clean only with dry cloth.
- 7) Do not block any ventilation openings. Install in accordance with the manufacturer's instructions.
- 8) Do not install near any heat sources such as radiators, heat registers, stoves, or other apparatus (including amplifiers) that produce heat.
- 9) Do not defeat the safety purpose of the polarized or grounding-type plug. A polarized plug has two blades with one wider than the other. A grounding type plug has two blades and a third grounding prong. The wide blade or the third prong are provided for your safety. If the provided plug does not fit into your outlet, consult an electrician for replacement of the obsolete outlet.
- 10) Protect the power cord from being walked on or pinched particularly at plugs, convenience receptacles, and the point where they exit from the apparatus.
- 11) Only use attachments/accessories specified by the manufacturer.
- 12) Unplug this apparatus during lightning storms or when unused for long periods of time.
- 13) Refer all servicing to qualified service personnel. Servicing is required when the apparatus has been damaged in any way, such as power-supply cord or plug is damaged, has been exposed to rain or moisture, does not operate normally, or has been dropped.

Apparatus shall not be exposed to dripping or splashing and no objects filled with liquids such as vases, shall be placed on the apparatus.



- This appliance is classified as a CLASS 1 LASER product.
- This product contains a low power laser device. To ensure continued safety, do not remove any cover or attempt to gain access to the inside of the product. Refer all servicing to qualified personnel only.

### Care and safety information

Avoid high temperatures, moisture, water and dust. Do not expose the system, batteries or discs to humidity, rain, sand or excessive heat (caused by heating equipment or direct sunlight). Always keep the disc tray closed to avoid dust on the lens.

#### Avoid condensation problem

The lens may cloud over when the player is suddenly moved from cold to warm surroundings. Making it impossible to play a disc. Leave the player in the warm environment until the moisture evaporates.

## **FCC RADIATION NORM**

### **FCC**

This equipment has been tested and found to comply with limits for Class B digital device pursuant to Part 15 of Federal Communications Commission (FCC) rules.

## **FCC Compliance Statement**

These limits are designed to provide reasonable protection against frequency interference in residential installation. This equipment generates, uses and can radiate radio frequency energy, and if not installed or used in accordance with the instructions, may cause harmful interference to radio communication. However, there is no guarantee that interference will not occur in television reception, which can be determined by turning the equipment off and on. The user is encouraged to try and correct the interference by one or more of the following measures:

- **Reorient or relocate the receiving antenna**
- **Increase the separation between the equipment and the receiver**
- **Connect the equipment into an outlet on a circuit different from that to which the receiver is connected to.**



### **CAUTION!**

The Federal Communications Commission warns the user that changes or modifications to the unit not expressly approved by the party responsible for compliance could void the user's authority to operate the equipment.

## Important Safeguards and Precautions

### Power Cord Protection

To avoid the unit from malfunctioning, and to protect against electric shock, fire or personal injury, please observe the following:

- Hold the plug firmly when connecting or disconnecting the AC power cord.
- Keep the AC power cord away from any heating appliances.
- Never put any heavy objects on the AC power cord.
- Do not attempt to repair or reconstruct the AC power cord in any way.

### Location and Handling

- Air vents are provided in the cabinet to prevent the temperature inside the unit from rising to dangerous levels. Do not place this unit in closed spaces, cover it, or otherwise block the vents.
- Do not place this unit in direct sunlight or near heat sources.
- Keep this unit away from strong magnetic objects.
- Do not insert or drop anything into this unit through the air vents as this could cause serious damage, possibly resulting in fire.
- Do not place any object containing water or other liquids on this unit. In the event that liquid should enter the cabinet, unplug this unit immediately and contact the service center immediately.
- Do not remove the cabinet. Touching parts inside the cabinet could result in electric shock and/or damage to the unit.
- Do not use the unit in a car.

### Nonuse Periods

- When the unit is not being used, make sure to keep the unit turned off.
- When left unused for a long period of time, the unit should be unplugged from the household AC outlet.

### Disc Tray

- Do not put any foreign objects on or in the disc tray.
- Do not push down on or place your fingers or hand in the disc tray.

### Stacking

- Place the unit in a horizontal position and do not place anything heavy on top of it.

### Condensation

Moisture may form on the pickup lens in the following conditions:

- Immediately after a heater has been turned on near the unit.
- In a steamy or very humid room.
- When the unit is suddenly moved from a cold environment to a warm one.

If moisture forms inside this unit, it may not operate properly. If this happens, remove power and place the unit at a well ventilated area and let the moisture to evaporate before using the unit again.

### On adjusting volume

- Do not turn up the volume while listening to a portion of music or movie with very low level inputs or no audio signals. If you do, the speakers may become damaged when a peak level portion is played.

### If There is Noise Interference on the TV While a Broadcast is Being Received

Depending on the reception condition of the TV, interference may appear on the TV monitor while you watch a TV broadcast if the DVD player is left on. This is not a malfunction of the unit or the TV. To watch a TV broadcast, turn off the DVD player.

### Service

- Do not attempt to service the unit yourself.
- Please refer any service to qualified technicians.

### Copyright

Audio-visual material may consist of copyrighted works which must not be recorded without the authority of the owner of the copyright. Please refer to relevant laws in your country.

### Copy protection

This DVD player supports Macrovision<sup>®</sup> copy protection.

On DVD discs that include a copy protection code, if the contents of the DVD disc are copied using a VCR, the copy protection code prevents the videotape copy from playing normally.

**Manufactured under license from Dolby<sup>®</sup> Laboratories. "Dolby" and the double-D symbol are trademarks of Dolby Laboratories.**

### Recommended Measures for Optimum Picture Excellence

This unit is a precision device that is constructed using extremely accurate technology.

Soiling or friction affecting the pickup lens or disc drive can impair the image quality. At the worst, neither video nor audio will be played back. To obtain optimum picture quality, the player should be checked (cleaning and replacement of some parts) every 1,000 hours. Note that this period varies depending on the environment (temperature, humidity, dust, etc..) in which the player is used.

**Do not attempt to clean the pickup lens yourself.**

## CAUTION

**"VENTILATION SHOULD NOT BE IMPEDED BY COVERING THE VENTILATION OPENINGS WITH ITEMS SUCH AS NEWSPAPER, TABLECLOTHS, CURTAINS, ETC."**

**"NO OPEN FLAME SOURCES, SUCH AS LIGHTED CANDLES, SHOULD BE PLACED ON THE APPARATUS."**

**"DO NOT EXPOSE THE APPARATUS TO MOISTURE, LIQUID, OR SPLASHING OF LIQUIDS. DO NOT PLACE OBJECTS FILLED WITH LIQUIDS, SUCH AS VASES, ON THE APPARATUS."**

# Table of Contents

## General Information

Features .....	6
DVD Region Code .....	6
Glossary of Disc Terms .....	6
System Notes .....	6
Notes on Using Discs .....	7
Accessories .....	7
Installing Batteries in the Remote Control .....	7

## Remote Control

Remote Control .....	8
----------------------	---

## Function Overview

Front Panel .....	9
Back Panel .....	9

## Connections

Connecting Your DVD Player to Your TV .....	10
---	----

## Basic Setup

Setup Menu .....	10
System Setup .....	11-12
Language Setup .....	12-13
Audio Setup .....	13-14
Video Setup .....	14-15

## Playing Discs

General Operation .....	15
Basic Playback .....	15-16
Playing MP3/JPEG Picture Discs .....	16
Using the Menu for DVD .....	17
Checking the Information .....	17
Program Play .....	18

## Special Functions

Picture Zooming .....	19
Selecting a Subtitle Language .....	19
Selecting the Audio Language .....	19
Angle Selection .....	19

<b>Troubleshooting .....</b>	<b>20</b>
------------------------------	-----------

<b>Specifications .....</b>	<b>21</b>
-----------------------------	-----------

<b>Warranties .....</b>	<b>22</b>
-------------------------	-----------

# General Information

## Features

- Stereo audio out.
- Compatible with DVD, DVD+R, DVD-R, DVD+RW, DVD-RW, MP3, CD-R, CD-RW, JPEG, Kodak.
- OSD menu display.
- Full function remote control.

## DVD Region Code

DVD players and discs are designed with region numbers which dictate the region (printed on the rear panel). If the region number does not match the region number in your DVD player, you will not be able to play the disc. If you try to play the DVD, the message **WRONG REGION** will appear on the OSD.

The region number for this DVD player is **1**.

## Discs That Can be Played

- DVD discs  
Multi-titles. Titles may be subdivided into chapters.
- Audio CDs and MP3  
Discs are divided into tracks.



### Note

- You cannot play CD-G, CD-EXTRA, CD-ROM, DVD-ROM and USB+HUB discs.
- You cannot play illegally produced discs.
- You cannot play scratched discs.
- Discs that are dusty, soiled or marked with fingerprints will not play properly, if at all.

## Glossary of Disc Terms

- Title (DVD)  
The longest sections of a picture or a music piece on a DVD; a movie, etc., for a picture piece on a video software; or an album, etc., for a music piece on an audio software. Each title is assigned a title number enabling you to locate the title you want.
- Chapter (DVD)  
Sections of a picture or a music piece that are smaller than titles. A title is composed of several chapters. Each chapter is assigned a chapter number enabling you to locate the chapter you want. Depending on the disc, no chapters may be recorded.

## System Notes

- Instructions in this manual describe the controls on the system. You can also use the controls on the remote control if they have the same or similar names as those on the system.
- The types of functions and operations that can be used for a particular disc vary depending on the features of that disc. In some cases, these functions and operations may differ from the descriptions given in this Operations Manual. In this event, follow the instructions given on the screen. This Operations Manual only covers basic disc operations.
- For some operations, "INVALID KEY" may appear on the screen. This indicates that the operation described in this Operations Manual is not permitted for the current disc.
- The drawings about the TV screen and front panel display used in this Operations Manual are purely for the purposes of explanation, the actual displays may differ slightly from what is shown here.

## General Information(continued)

### Notes on Using Discs

#### Disc handling precautions

- To keep the disc clean, handle the disc by its edge. Do not touch the surface.
- Do not stick paper or tape on the disc.

If there is glue (or a similar substance) on the disc, remove the glue completely before using the disc.

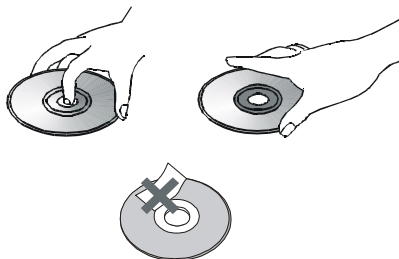

- Do not expose the disc to direct sunlight or heat sources such as hot air ducts, or leave it in a car parked in direct sunlight as a considerable rise in temperature will adversely affect the disc.
- After playing, store the disc in its case.
- Do not write on the label side with a ball-point pen or other writing implements.
- Be careful not to drop, bend, or crack the disc.

#### Disc cleaning precautions

- Before playing, clean the disc with a cleaning cloth. Wipe the disc from the center outward.

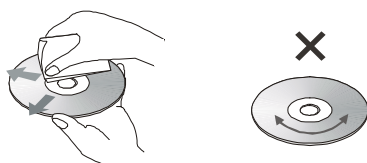

- Do not use solvents such as benzine, thinner, commercially available cleaners or antistatic spray intended for vinyl LPs.

#### Disc playing precautions

- Do not place more than one disc in the disc tray at a time.
- Do not place the disc wrong side up in the tray.
- Do not try to close the disc tray when the disc is not placed properly in the tray.

### Accessories

Check that the following items came with your DVD Player:

- Video/Audio Cable x1
- Remote Control x1
- AAA batteries x2
- User's Manual

### Installing Batteries in the Remote Control

1. Open the battery cover on the back of the remote.
2. Insert two AAA batteries, making sure that the polarities (+ and -) are aligned correctly.
3. Replace the battery cover.

You can control the system using the supplied remote. When using the remote, point it at the remote sensor on the front panel of this system.

If remote doesn't operate properly:

- Check that the batteries were installed according to the proper polarity.
- Check that the batteries are not dead. Always replace both batteries at the same time with fresh, new batteries.
- Check if the remote sensor is blocked by an object.

#### NOTE:

- Do not leave the remote in an extremely hot or humid place.
- Do not use a new battery with an old one, always replace the batteries at the same time using fresh, new batteries.
- Do not drop any foreign objects into the remote casing, particularly when replacing the batteries.
- Do not expose the remote sensor to direct sunlight or lighting apparatuses, doing so may cause the remote to malfunction.
- If you do not use the remote for an extended period of time, remove the batteries to avoid any possible damage from battery leakage and/or erosion.

# Remote Control

## Remote Control

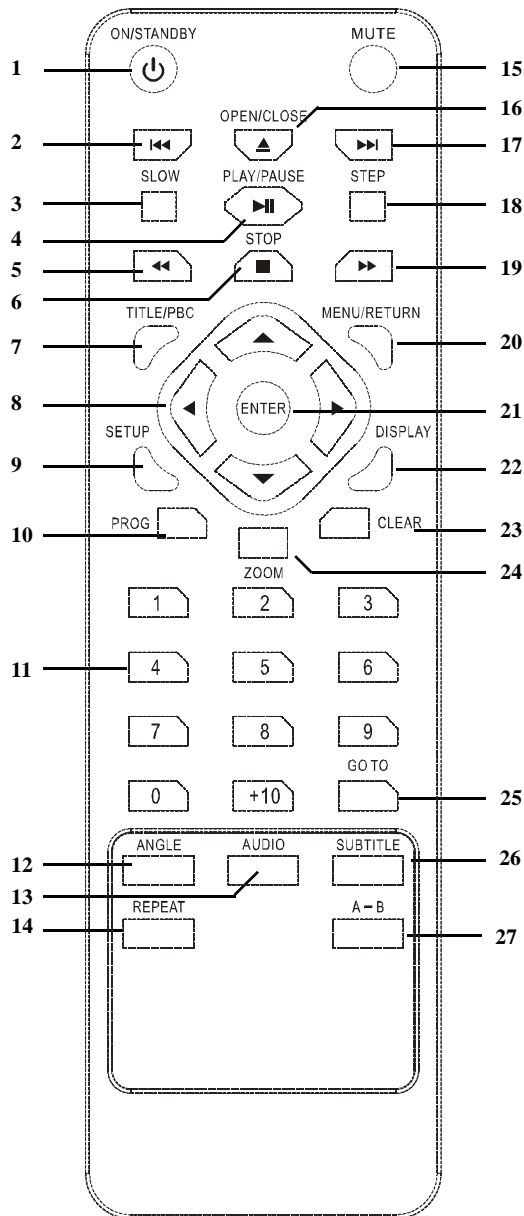

5. **FAST REVERSE:** Press to fast reverse through the currently playing disc and/or track.
6. **STOP:** Press to stop playback.
7. **TITLE/PBC:** In DVD mode press to return to the menu. In VCD mode press to switch the PBC on/off.
8. **DIRECTION BUTTONS:** Press to select the item you want.
9. **SETUP:** Press to enter into the SETUP menu.
10. **PROGRAM:** Press to program the tracks.
11. **NUMBER KEYS:** Press to select the items or settings directly.
12. **ANGLE:** Press to access various camera angles on the DVD.
13. **AUDIO:** Press to change the audio channels of a DVD or select stereo, left, or right audio channel of a VCD disc.
14. **REPEAT:** Press to select variations of continuous play.
15. **MUTE:** Press to disable or enable sound output.
16. **OPEN/CLOSE:** Press to open or close the disc tray.
17. **NEXT SKIP:** Press to skip to the next chapter or track.
18. **STEP:** Press to view playback frame by frame.
19. **FAST FORWARD:** Press to fast forward through the currently playing disc or track.
20. **MENU/RETURN:** In DVD mode, press to select the menu play. In VCD mode, press to return to the PBC.
21. **ENTER:** Press to enter a command or confirm a selection.
22. **DISPLAY:** Press to show the information about the currently playing disc.
23. **CLEAR:** Press to clear what you have selected or input.
24. **ZOOM:** Press to enlarge the picture.
25. **GOTO:** Press to go to the desired starting title, chapter, track or time.
26. **SUBTITLE:** Press to access the various subtitle languages.
27. **A-B:** Specifies a section and plays it repeatedly.

1. **ON/STANDBY :** Press to turn the unit on and off.
2. **PREV SKIP:** Press to skip to the previous chapter or track.
3. **SLOW :** Press to select the forward slow speed playback.
4. **PLAY/PAUSE :** Press to start or pause playback.



# Function Overview

## Front Panel

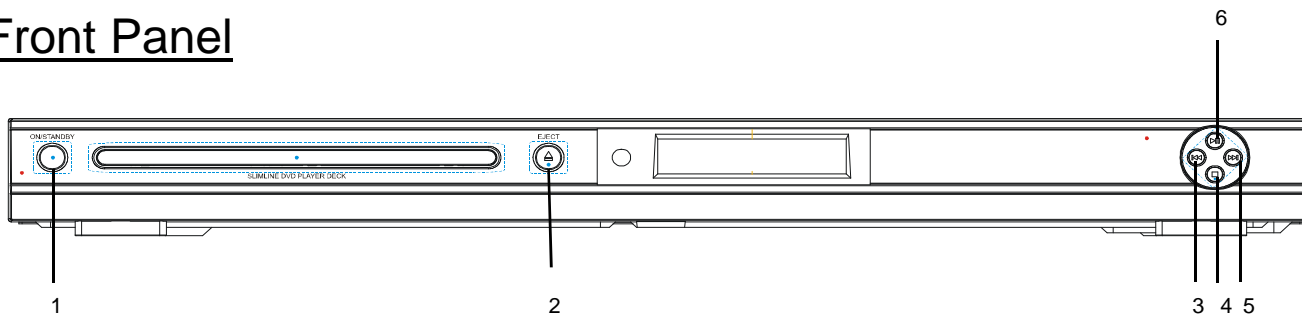

1. ON/STANDBY Button : Press to switch between power on and standby mode
2. EJECT ▲ Button : Press to open or close the disc tray
3. BACK ⏮ Button : Press to skip to the previous track (only during playback)
4. STOP ■ Button : Press to stop playback
5. FWD ⏭ Button : Press to skip to the next track (only during playback)
6. PLAY/PAUSE ▶⏸ Button : Press to start or pause disc playback

## Back Panel

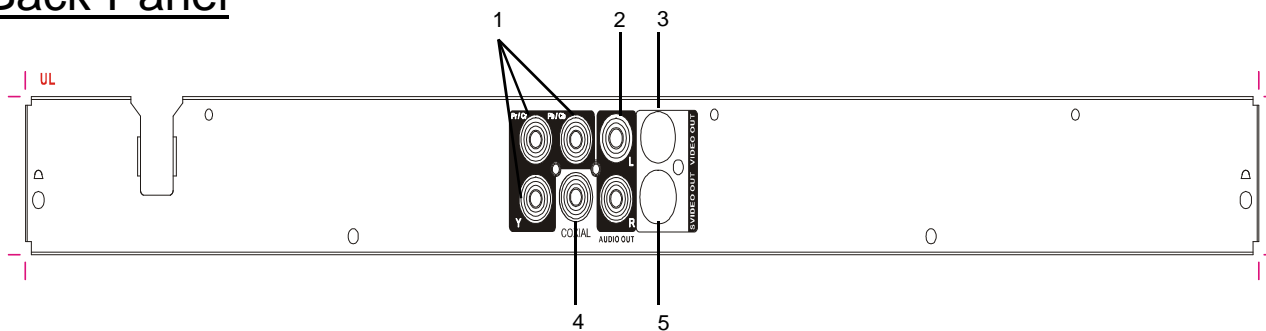

1. COMPONENT(Pr/Pb/Y) VIDEO OUT Jack : Connects to the Pr/Pb/Y input of TV
2. AUDIO OUT( L/R) : Connects to a TV set or stereo receiver
3. VIDEO OUT Jack : Connects to the video input of a TV
4. COAXIAL OUT Jack : Connects to an optional receiver
5. S-VIDEO OUT Jack : Connects to the S-video input of a TV

# Connections

## Connecting Your DVD Player to Your TV

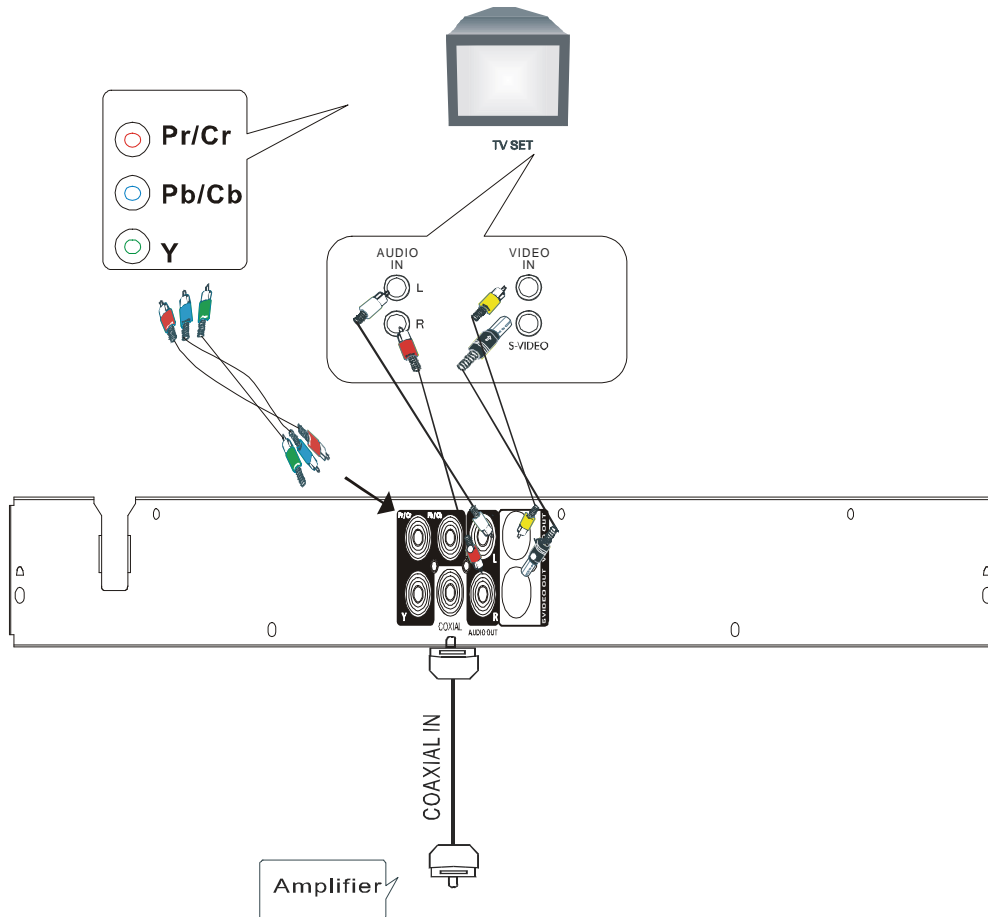

- \* Connect the **S-VIDEO OUT** jack to the **S-Video** input jack on the TV using an S-Video cable.
- \* Connect the **VIDEO OUT** jack to the **Video** input jack on the TV using a video cable.
- \* Use the audio cables to connect the **AUDIO OUT** jacks to the corresponding **AUDIO IN** jacks on your TV, CD or TAPE recorder.
- \* Use the Digital cables to connect the **COAXIAL** jack to correspond to receive a digital signal.

# Basic Setup

In the top menu select the Setup Menu to enter in order to make any setup changes.

In the Setup Menu, select the **Setup Menu** option to make changes to the setup. For purposes of this manual the setup options are described from top to bottom order, beginning with the **SYSTEM SETUP** menu.

Some settings interact, what you choose in one menu can affect how another selection works. If you see a selection that is grayed out, that means that the selection interacts with one or more other selections that are set in such a way as to render the grayed out selection inoperable.

## SETUP MENU

In the top menu, move the highlight to the Setup Menu (the SETUP MENU should be operated in full stop mode).

- **SYSTEM SETUP**
- **LANGUAGE SETUP**
- **AUDIO SETUP**
- **VIDEO SETUP**

## SYSTEM SETUP

The system setup is carried out via the TV, enabling you to customize the DVD system to suit your particular requirements. If the options selected are not available on a disc, then the disc's default settings will be used.

1. Press **SETUP** on remote control in stop mode.
2. Use **◀/▶/▲/▼** to select the item you want.
3. Press **ENTER** to confirm the selection.
4. To exit the setup, press **SETUP** again.

This section includes:

- TV SYSTEM
- TV TYPE
- SCREEN SAVER
- PASSWORD
- RATING
- DEFAULT

## TV SYSTEM

You can setup the color system of this unit to match your connected TV set. If the color system of this unit is different from that of the TV set, the images will not be displayed normally on the screen.

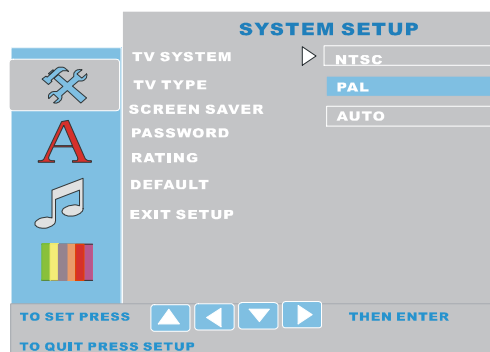
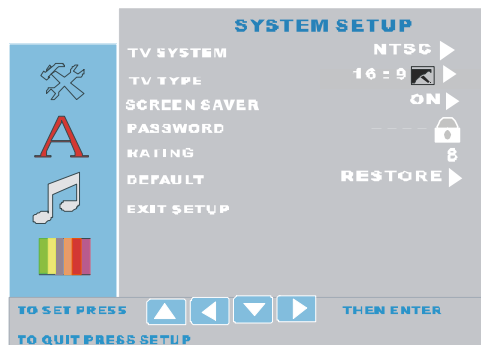

## TV TYPE

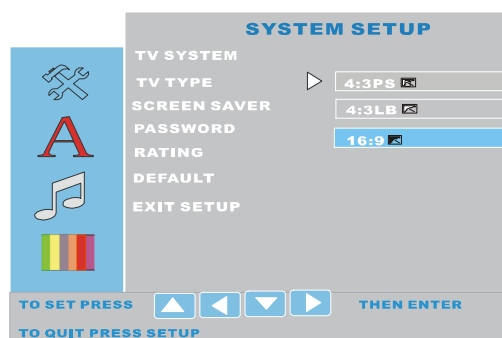

### 4:3 PS

If you have a conventional TV set and your DVD is not formatted for widescreen viewing, use this setting. A wide picture is displayed on the whole TV screen with a portion automatically cut off.

### 4:3 LB

If you have a conventional TV set and your DVD is formatted for widescreen viewing, use this setting. Wide bands will be displayed on the upper and lower portions of the TV screen.

# Basic Setup(continued)

## 16:9

If you have a widescreen TV set, use this setting (you must also set your widescreen TV to Full size).

## SCREEN SAVER

The default setting for the SCREEN SAVER is ON. the screen saver image appears when you leave the system in stop mode for about 5 minutes.

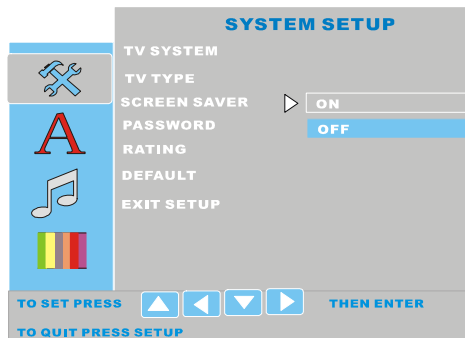

## DEFAULT

If you select this function, all of the functions will restore to the original settings, except the rating.

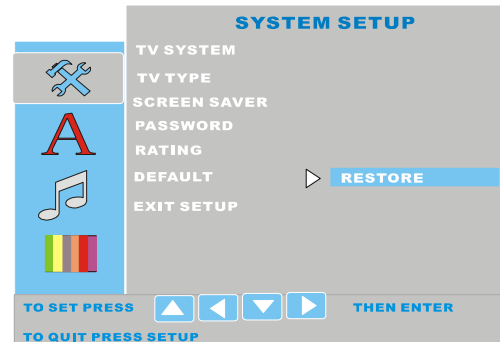

## PASSWORD

The password is used to change the parental control settings. When you use this unit for the first time, enter the default password "3308".

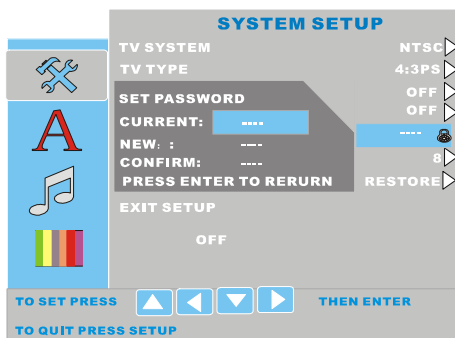

## LANGUAGE SETUP

1. Press **SETUP** on the remote control.
2. Use **◀/▶/▲/▼** to select item you want.
3. Press **ENTER** to confirm the selection.
4. To exit the setup, press **SETUP** again.

This section includes:

- OSD LANGUAGE
- AUDIO LANG
- SUBTITLE LANG
- MENU LANG
- DRM REG CODE

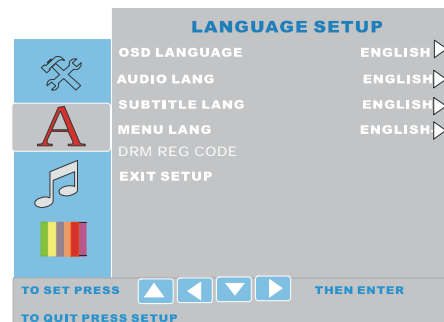

## RATING

After you enter the password, you can choose the **RATING**. The default setting is **8**.

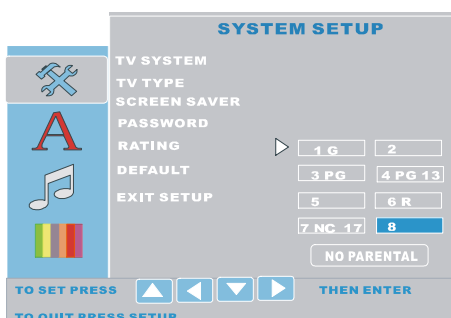

# Basic Setup(continued)

## OSD LANGUAGE

- ENGLISH
- SPANISH

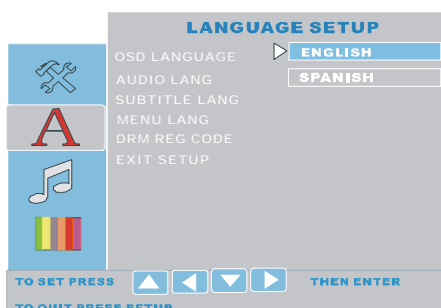

The default setting for the **OSD LANGUAGE** is **ENGLISH**.

## AUDIO LANG, SUBTITLE LANG, MENU LANG

This function allows you to select the desired language. It includes:

- ENGLISH
- JAPANESE
- FRENCH
- SPANISH

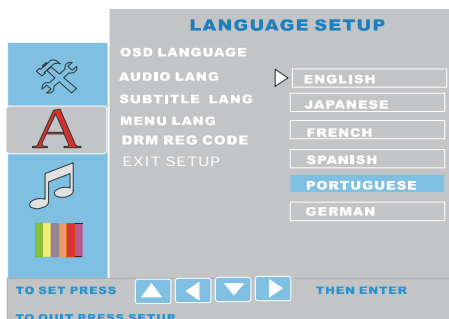

## DRM REG CODE

1. Select DRM REG CODE.
2. Press ENTER, a message screen will appear as below:

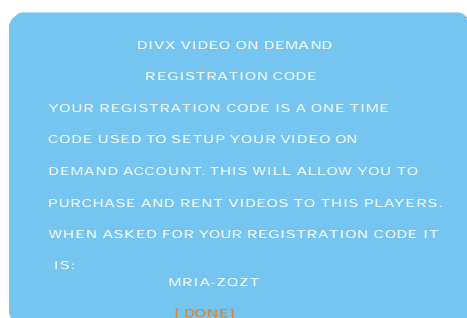

3. Write down this VOD 8-character registration number in order to fill in the form on the web site you rent/purchase your DivX VOD files.
4. Select DONE to return.

## AUDIO SETUP

1. Press **SETUP** on the remote control.
2. Use **◀/▶/▲/▼** to select the item you want.
3. Press **ENTER** to confirm the selection.
4. To exit the setup, press **SETUP** again.

This section includes:

- DIGITAL OUT
- DOWN SAMPLE
- DOWNMIX

## DIGITAL OUT

The default setting is **RAW**.

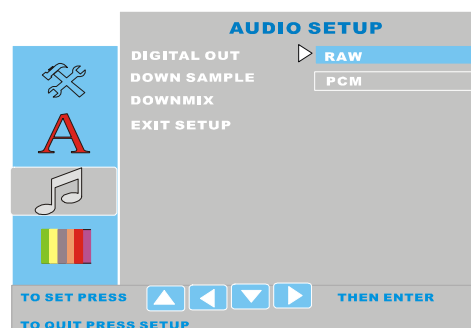

## DOWN SAMPLE

- 48K
- 96K
- 192K

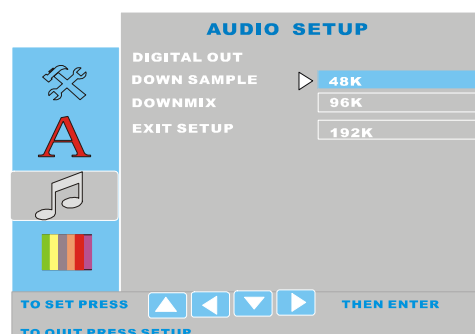

The default setting for the **DOWN SAMPLE** is **48K**.

# Basic Setup(continued)

## DOWN MIX

To play a DVD disc recorded with surround multi-channel audio correctly. Select the appropriate setting according to your audio system.

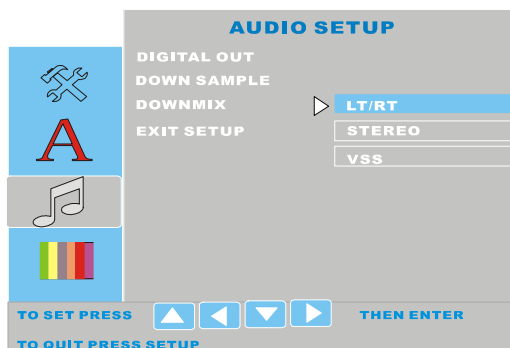

- **LT/RT**  
When the disc you played has **PRO LOGIC** stereo function, you can select this.
- **STEREO**  
2-channel stereo output, for stereo listening through the analog left and right outputs.
- **VSS**  
2-channel virtual surround outputs.

**Note:** Depending on the disc, the actual outputs may not match your selection.

## VIDEO SETUP

1. Press **SETUP** on the remote control.
2. Use **◀/▶/▲/▼** to select item you want.
3. Press **ENTER** to confirm the selection.
4. To exit the setup, press **SETUP** again.

This section includes:

- **BRIGHTNESS**
- **CONTRAST**
- **HUE**
- **SATURATION**
- **VIDEO OUT**

## BRIGHTNESS, CONTRAST, HUE, SATURATION

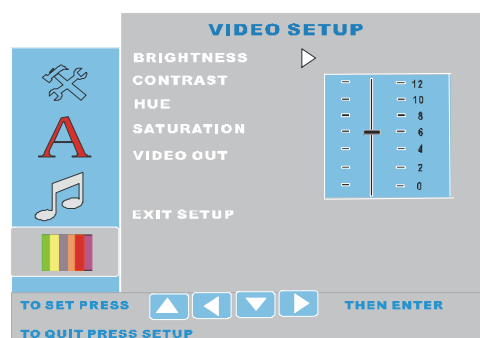

The **BRIGHTNESS**, **CONTRAST**, and **SATURATION** are the same User Interface. The default setting for the **BRIGHTNESS** and the **CONTRAST** is **6**; the default setting for the **HUE** and the **SATURATION** is **0**.

## HUE

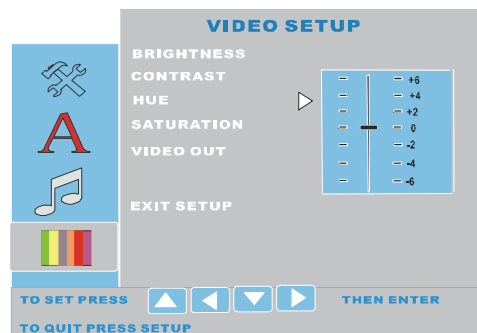

## VIDEO OUT

- **YUV**
- **S-VIDEO**
- **P-SCAN**

## P-SCAN

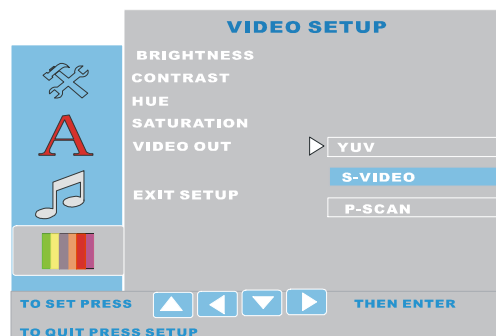

The default setting for the **P-SCAN** is **OFF**. If you set it **ON** and your TV support this function then it will appear as follows.

# Playing Discs



If you select **OK**, it will appear as below.

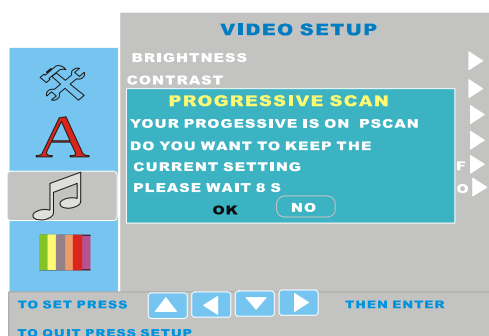

## General operation

- 1 After all the connections are properly completed, plug the AC power cord of the player to an appropriate wall outlet.
- 2 Press **ON/STANDBY** to turn **ON** the main power.
- 3 Press **OPEN/CLOSE** to open the disc tray, press again to close the disc tray.
- 4 Press **MUTE** to shut off the sound. To restore the volume, press **MUTE** again.

## Basic playback

### Start playback

- Press **▶/II** to start playback, to pause playback, press **▶/II** again.

### Note

- Some discs will start playing automatically, and others will display the menu on the TV screen. use the **◀/▶ / ▲/▼** buttons to select the track, or press the number keys (**0 ~ 9,+10**) to go to the desired track/chapter.

### Stop playback

- Press **STOP ■**.

### Skip to another track/chapter

- Press **I◀◀/▶▶I** repeatedly during playback to skip to the next or previous track/chapter.

### Fast search

- 1 Press and hold **◀◀ / ▶▶** for more than 1 second to fast reverse or fast forward.

#### • For DVD/MP3/CD discs

FF (fast forward) : FF x2, FF x4, FF x8, FF x20.

FR (fast reverse) : FR x2, FR x4, FR x8, FR x20.

- 2 To resume normal play, press **▶/II**.

Press **SLOW** to play the currently playing disc in slow motion.

#### • For DVD discs

Press it repeatedly to select the slow motion speed:

SF (slow forward) : SF 1/2, SF 1/3, SF 1/4, SF 1/5, SF 1/6, SF 1/7.

# Playing Discs(continued)

## Repeat

### 1. For DVD discs

Press **REPEAT** repeatedly to select the following:

REP: [ OFF ]  
↓  
REP: [ CHAPTER ]  
↓  
REP: [ TITLE ]  
↓  
REP: [ REP ALL ]

### 2. For CD discs

Press **REPEAT** repeatedly to select the following.

REP: [ OFF ]  
↓  
REP: [ REP 1 ]  
↓  
REP: [ REP ALL ]

### 2. For MP3/DIVX discs

Press **REPEAT** repeatedly to select the following.

REP: [ OFF ]  
↓  
REP: [ REP 1 ]  
↓  
REP: [ REP DIR ]  
↓  
REP: [ REP ALL ]

## Playing MP3, DIVX, or JPEG picture discs

1. Load an MP3, DIVX, or JPEG disc.
2. Playback should start automatically, if it does not, then press the ►/|| button to start playback.
3. Press I◀◀/▶▶I to select the previous or next track.
4. While in stop mode, press the ◀/▶/▲/▼ button to select a desired album title, then press the ►/|| button to start playback.
5. To stop playback, press **STOP** ■.

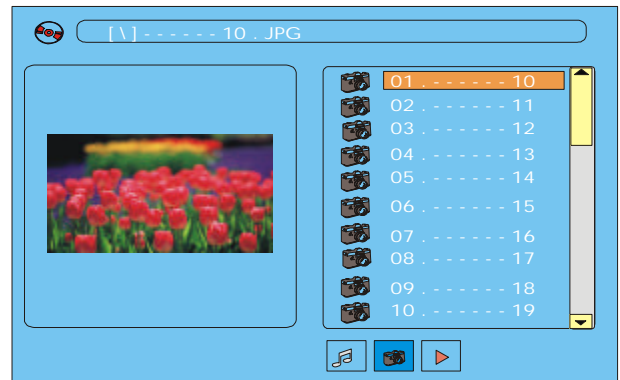



# Playing Discs(continued)

## Using the Menu for DVD

- 1 Press **MENU/RETURN** while playing a DVD disc.  
The TITLE MENU will appear on the TV screen. The contents of the menu vary from disc to disc.
- 2 Use the **◀/▶/▲/▼** buttons to select the title (or chapter) you want to play.  
Depending on the disc, you can use the number buttons (**0-9,+10**) to select the title (or chapter).
- 3 Press **ENTER** to start playback.
- 4 To change other items, repeat Step 1 ~ 2.

### Note:

- Depending on the DVD disc, you may not be able to select the title or chapter.
- Depending on the DVD disc, a Title Menu may simply be called a menu or root menu in the instructions supplied with the disc.
- For some DVD discs, when you press the **MENU/RETURN** button, the playback will restart from the beginning of the disc.

## Checking the information

You can check information about the disc, such as the total number of the titles or chapters or tracks or time, using the Display function. The information you want will appear on the TV screen.

### When playing a DVD

- 1 Press **DISPLAY** repeatedly to show the following (for reference only):

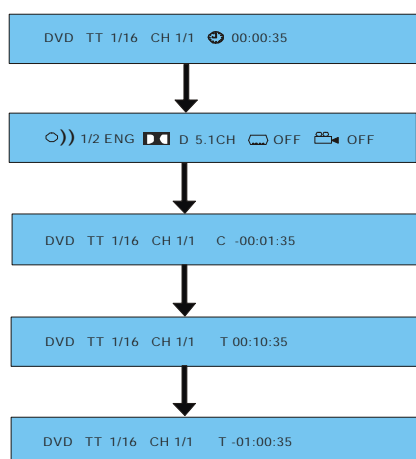

- 2 Press **DISPLAY** again, and the information will disappear.

### When playing back a CD

- 1 Press **DISPLAY** repeatedly to show the following (for reference only):

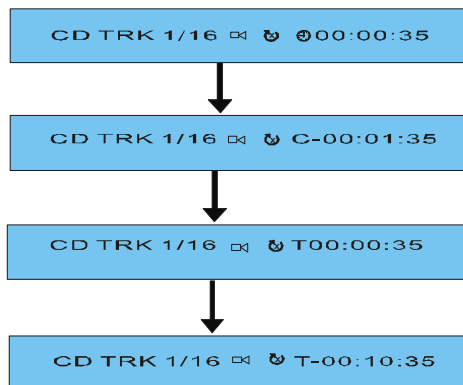

- 2 Press **DISPLAY** again, the information will disappear.

### When playing back a DIVX disc

- 1 Press **DISPLAY** repeatedly to show the following (for reference):

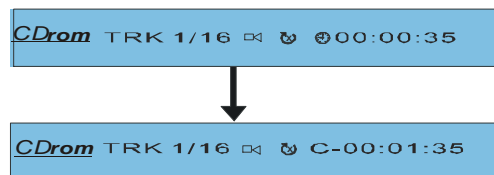

- 2 Press **DISPLAY** again, the information will disappear.

## Playing Discs(continued)

### Program play

You can play the contents of the disc in a specific order by programming the order of the tracks to be played.

- 1 While playback is stopped, select or press **PROGRAM** to enter the program mode.
- 2 Use the number buttons (**0 ~ 9,+10**) to input the track numbers in the order you want.
- 3 Repeat step 2 to store other tracks.
- 4 To start program play, press **▶/II**.
- 5 To stop playback, press **■** once.
- 6 To cancel the program, press **■** again.

For VCD & CD disc



# Special Function

## Picture Zooming

This function allows you to enlarge the picture on the TV screen and to pan through the enlarged image.

- 1 Press **ZOOM** repeatedly to select a zoom factor as below:

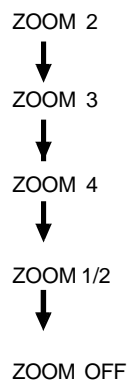

- 2 To pan through the enlarged image, press the ◀/▶/▲/▼ buttons to move the zoomed picture left, right, up or down.

## Selecting a Subtitle Language

This function can only be used for DVD discs recorded with multi-subtitle language.

Press **SUBTITLE** repeatedly to select a subtitle language.

### Note

- Press **Subtitle** once to show the current selection. Pressing **Subtitle** again will bring you through the other available subtitle setting(s).
- During some scenes, the subtitles may not appear immediately after you turn them on.

## Selecting the Audio Language

Depending on some DVD discs, you may be able to change the audio format (including audio recording type, number of channels recorded and audio language).

- Press **Audio** during playback.
- Press ▶/◀ to select.



## Angle selection

Some DVD discs contain scenes which have been shot simultaneously from a number of different angles. For these discs, the same scenes can viewed from each of the different angles.

- 1 Press the **ANGLE** button to change the scenes from one angle to other angle(s). For example: 1/3, 2/3, 3/3.



# Troubleshooting

If you experience any of the following difficulties while using the system, use this troubleshooting guide to help you remedy the problem. Should any problem persist, please call tech support listed on the warranty.

## No power

- Is the power cord firmly plugged into the power outlet?
- One of the safety mechanisms may be operating. In this event, unplug the player from the power outlet briefly and then plug it in again.

## No picture

- Check that the system's cables are connected securely.
- The video connecting cord is damaged. Replace it with a new one.
- Make sure you connect the system to the video input connector on your TV.
- Make sure you turn on the TV.
- Make sure you select the video input on the TV so that you can view the pictures from this system.

## The picture quality is low

- Clean the disc.
- If video from this system has to go through your VCR to get to your TV, the copy-protection applied to some DVD programs could affect picture quality. If you still experience problems after checking your connections, please try connecting your DVD system directly to your TV's S-Video input, if your TV is equipped with this input.

## The aspect ratio of the screen cannot be changed even though you set TV DISPLAY in the SETUP menu when you play a wide picture.

- The aspect ratio is fixed on your DVD disc.
- If you connect the system with the S-Video cable, connect directly to the TV. Otherwise, you may not be able to change the aspect ratio.
- Depending on the TV, you may not be able to change the aspect ratio.

## There is no sound or only a very low-level sound is heard.

- The system is in pause mode, in slow-motion play mode, or fast forward or fast reverse is performed. Press ►/II to return to normal play mode.
- Make sure that the audio cable is connected securely.

## External noise is heard

- Check that the connecting cords are away from a transformer or motor.
- Move your TV away from the audio components.
- The plugs and jacks may be dirty. Wipe them with a cloth slightly dampened with alcohol.
- Clean the disc.

## The sound loses stereo effect when you play CD

- Set the Audio mode to **STEREO** in the **SETUP** menu.
- Make sure you connect the system cables appropriately.

## The surround effect is difficult to hear when you are playing a Dolby Digital sound track

- Depending on the DVD disc, the output signal may not be the entire 5.1 channel but may be monaural or stereo even if the sound track is recorded in Dolby Digital format.

## The language for the subtitles cannot be changed when you play a DVD

- Multilingual subtitles are not recorded on the DVD.
- Changing the language for the subtitles may be prohibited on the DVD.

## The subtitles cannot be turned off when you play a DVD

- Depending on the DVD, you may not be able to turn the subtitles off.

## The angles cannot be changed when you play a DVD

- Multi-angles are not recorded on the DVD.
- Make sure to change the angles when the angle mark appears on the TV screen.
- Changing the angles may be prohibited on the DVD.

## The system does not operate properly

- Static electricity, etc., may affect the system's operation. Press the **STANDBY** button to turn the unit off, wait one minute, then press again to turn the unit back on.

# Specifications

## DVD section

Laser type .....	Semiconductor laser, Wavelength 650 nm
Signal system .....	PAL625/50,NTSC525/60
Video output level .....	1 Vp-p (75 ohm)
Video Y output level .....	714 Vp-p (75 ohm)
Video C output level .....	286 mVp-p (75 ohm)

Digital output ..... Coaxial

### Video signal

Horizontal resolution: ..... 480lines

S/N ratio: ..... 60dB

### Audio signal

Audio frequency response ..... DVD (PCM)20 Hz - 22 kHz (+/-1.0 dB)  
CD 20 Hz - 20 kHz (+/-1.0dB)

S/N ratio ..... 80dB

Dynamic range: ..... DVD(PCM): 85dB  
CD: 85dB

Audio L/R : ..... 2V 1K Hz 0dB

Distortion ..... 0.1%

## General

Power supply .....	120V~60Hz
Power consumption .....	15W

\*Specifications subject to change without prior notice.

# One Year Limited Warranty

This product is warranted to be free from defects in material and workmanship for a period of one year. Warranty obligations are limited to the replacement or repair of defective parts and components, at the option of the manufacturer. The warranty of this product is null and void if the product is subjected to negligence, abuse, modification, misuse, accident or if the customer uses the product for a function it was not intended for. The warranty is only VALID FOR the original purchaser of this product and will not be honored if the product is resold.

The manufacturer will not be liable for incidental or consequential damages caused by the use of this product. The manufacturer will not be liable for any costs such as lost profits or revenues, cost of temporary replacements, loss of data, loss of equipment or use of equipment or any claims by third parties.

**TO OBTAIN SERVICE:** please call the toll free number mentioned below to obtain service. Do not return this product to the store. A customer representative will give you a return authorization number (RA number) allowing you to ship your product to the service center. The purchaser must have a copy of the original receipt for proof of purchase within one year. The purchaser of this product is responsible for any shipping costs to the repair facility. The manufacturer service center will repair or replace the unit in question and send it back to the purchaser within 7 working days of receipt of the unit.

In order to contact the repair facility, please call toll free between the hours of 9:00 am and 5:30 pm EST 1-866-611-2881

Or e-mail at [IT@FerrisMarketing.com](mailto:IT@FerrisMarketing.com)



# Garantía Limitada Por Un Año

Garantizamos que este producto estará libre de defectos de material y de fabricación por un año. Las obligaciones de esta garantía se limitan al reemplazo o reparación de las piezas y componentes defectuosos, a elección del fabricante. La garantía de este producto será anulada si el producto sufre negligencia, abuso, modificación, uso incorrecto, un accidente, o si el cliente utiliza el producto para una función para la que no fue diseñado. Esta garantía es válida solamente para el comprador original del producto y no será aplicada si el producto se revende.

El fabricante no será responsable por daños incidentales o consiguientes causados por el uso de este producto. El fabricante tampoco será responsable por costos como la pérdida de ganancias, costo de reemplazo temporal, pérdida de datos, pérdida del equipo o del uso del equipo, o cualquier reclamo de terceras partes.

**PARA OBTENER SERVICIO:** por favor llame al número sin cargo mencionado más abajo. No Devuelva este producto a la tienda donde lo adquirió. Un representante de servicios de atención al cliente le dará un numero de autorización de devolución (numero RA) que le permitirá enviar su producto al centro de servicio. El comprador deberá tener una copia del recibo original como prueba de compra durante el año previo. El comprador de este producto es responsable de los gastos de envío al centro de reparación. El centro de servicio del fabricante reparará o reemplazará la unidad en cuestión y la enviará al comprador dentro de 7 días de trabajo desde haber recibido el producto.

Para ponerse en contacto con el centro de servicio, por favor llame sin cargo al 1-866-611-2881 entre las 9:00 am y las 5:30 pm EST o e-mail [IT@FerrisMarketing.com](mailto:IT@FerrisMarketing.com)

