

DENON

DVD VIDEO AUTO CHANGER

DVM-1835

OPERATING INSTRUCTIONS

MODE D'EMPLOI

INSTRUCCIONES DE FUNCIONAMIENTO

WARNING: TO REDUCE THE RISK OF FIRE OR ELECTRIC SHOCK, DO NOT EXPOSE THIS APPLIANCE TO RAIN OR MOISTURE.



CAUTION
RISK OF ELECTRIC SHOCK



The lightning flash with arrowhead symbol, within an equilateral triangle, is intended to alert the user to the presence of uninsulated "dangerous voltage" within the product's enclosure that may be of sufficient magnitude to constitute a risk of electric shock to persons.



The exclamation point within an equilateral triangle is intended to alert the user to the presence of important operating and maintenance (servicing) instructions in the literature accompanying the appliance.

CAUTION:

TO REDUCE THE RISK OF ELECTRIC SHOCK, DO NOT REMOVE COVER (OR BACK). NO USER SERVICEABLE PARTS INSIDE. REFER SERVICING TO QUALIFIED SERVICE PERSONNEL.

IMPORTANT SAFEGUARDS

- 1) Read Instructions - All the safety and operating instructions should be read before the product is operated.
- 2) Retain Instructions - The safety and operating instructions should be retained for future reference.
- 3) Heed Warnings - All warnings on the product and in the operating instructions should be adhered to.
- 4) Follow Instructions - All operating and use instructions should be followed.
- 5) Cleaning - Unplug this product from the wall outlet before cleaning. Do not use liquid cleaners or aerosol cleaners. Use a damp cloth for cleaning.
- 6) Attachments - Do not use attachments not recommended by the product manufacturer as they may cause hazards.
- 7) Water and Moisture - Do not use this product near water - for example, near a bath tub, wash bowl, kitchen sink, or laundry tub; in a wet basement; or near a swimming pool; and the like.
- 8) Accessories - Do not place this product on an unstable cart, stand, tripod, bracket, or table. The product may fall, causing serious injury to a child or adult, and serious damage to the product. Use only with a cart, stand, tripod, bracket, or table recommended by the manufacturer, or sold with the product. Any mounting of the product should follow the manufacturer's instructions, and should use a mounting accessory recommended by the manufacturer.
- 9) A product and cart combination should be moved with care. Quick stops, excessive force, and uneven surfaces may cause the product and cart combination to overturn.
- 10) Ventilation - Slots and openings in the cabinet are provided for ventilation and to ensure reliable operation of the product and to protect it from overheating, and these openings must not be blocked or covered. The openings should never be blocked by placing the product on a bed, sofa, rug, or other similar surface. This product should not be placed in a built-in installation such as a bookcase or rack unless proper ventilation is provided or the manufacturer's instructions have been adhered to.
- 11) Power Sources - This product should be operated only from the type of power source indicated on the marking label. If you are not sure of the type of power supply to your home, consult your product dealer or local power company. For products intended to operate from battery power, or other sources, refer to the operating instructions.
- 12) Grounding or Polarization - This product may be equipped with a polarized alternating-current line plug (a plug having one blade wider than the other). This plug will fit into the power outlet only one way. This is a safety feature. If you are unable to insert the plug fully into the outlet, try reversing the plug. If the plug should still fail to fit, contact your electrician to replace your obsolete outlet. Do not defeat the safety purpose of the polarized plug.
- 13) Power-Cord Protection - Power-supply cords should be routed so that they are not likely to be walked on or pinched by items placed upon or against them, paying particular attention to cords at plugs, convenience receptacles, and the point where they exit from the product.
- 14) Lightning - For added protection for this product during a lightning storm, or when it is left unattended and unused for long periods of time, unplug it from the wall outlet. This will prevent damage to the product due to lightning and power-line surges.
- 15) Power lines - An outside antenna system should not be located in the vicinity of overhead power lines or other electric light or power circuits, or where it can fall into such power lines or circuits. When installing an outside antenna system, extreme care should be taken to keep from touching such power lines or circuits as contact with them might be fatal.
- 16) Overloading - Do not overload wall outlets, extension cords, or integral convenience receptacles as this can result in a risk of fire or electric shock.
- 17) Object and Liquid Entry - Never push objects of any kind into this product through openings as they may touch dangerous voltage points or short-out parts that could result in a fire or electric shock. Never spill liquid of any kind on the product.
- 18) Servicing - Do not attempt to service this product yourself as opening or removing covers may expose you to dangerous voltage or other hazards. Refer all servicing to qualified service personnel.
- 19) Damage Requiring Service - Unplug this product from the wall outlet and refer servicing to qualified service personnel under the following conditions:
 - a) When the power-supply cord or plug is damaged.
 - b) If liquid has been spilled, or objects have fallen into the product.
 - c) If the product has been exposed to rain or water.
 - d) If the product does not operate normally by following the operating instructions. Adjust only those controls that are covered by the operating instructions as an improper adjustment of other controls may result in damage and will often require extensive work by a qualified technician to restore the product to its normal operation.
 - e) If the product has been dropped or damaged in any way.
 - f) When the product exhibits a distinct change in performance - this indicates a need for service.
- 20) Replacement Parts - When replacement parts are required, be sure the service technician has used replacement parts specified by the manufacturer or have the same characteristics as the original part. Unauthorized substitutions may result in fire, electric shock, or other hazards.
- 21) Safety Check - Upon completion of any service or repairs to this product, ask the service technician to perform safety checks to determine that the product is in proper operating condition.
- 22) Heat - The product should be situated away from heat sources such as radiators, heat registers, stoves, or other products (including amplifiers) that produce heat.

PORTABLE CART WARNING
(Symbol provided by RETAC)



S3125A

PRECAUTIONS

Laser Safety

This unit employs a laser. Only a qualified service person should remove the cover or attempt to service this device, due to possible eye injury.

CAUTION: USE OF CONTROLS OR ADJUSTMENTS OR PERFORMANCE OF PROCEDURES OTHER THAN THOSE SPECIFIED HEREIN MAY RESULT IN HAZARDOUS RADIATION EXPOSURE.

CAUTION: VISIBLE AND INVISIBLE LASER RADIATION WHEN OPEN AND INTERLOCK DEFEATED. DO NOT STARE INTO BEAM.

LOCATION: INSIDE, NEAR THE DECK MECHANISM.

FCC WARNING- This equipment may generate or use radio frequency energy. Changes or modifications to this equipment may cause harmful interference unless the modifications are expressly approved in the instruction manual. The user could lose the authority to operate this equipment if an unauthorized change or modification is made.

RADIO-TV INTERFERENCE

This equipment has been tested and found to comply with the limits for a Class B digital device, pursuant to Part 15 of the FCC Rules. These limits are designed to provide reasonable protection against harmful interference in a residential installation. This equipment generates, uses, and can radiate radio frequency energy and, if not installed and used in accordance with the instructions, may cause harmful interference to radio communications. However, there is no guarantee that interference will not occur in a particular installation. If this equipment does cause harmful interference to radio or television reception, which can be determined by turning the equipment off and on, the user is encouraged to try to correct the interference by one or more of the following measures:

- 1) Reorient or relocate the receiving antenna.
- 2) Increase the separation between the equipment and receiver.
- 3) Connect the equipment into an outlet on a circuit different from that to which the receiver is connected.
- 4) Consult the dealer or an experienced radio/TV technician for help.

This Class B digital apparatus complies with Canadian ICES-003.

CAUTION: TO PREVENT ELECTRIC SHOCK, MATCH WIDE BLADE OF PLUG TO WIDE SLOT, FULLY INSERT.

Non-use periods - Turn off the unit when it is not in use. Unplug the unit from the household AC outlet if it is not to be used for a long time. Unplug the unit during lightning storms.

Please read this operating instructions carefully before using your DVD player, and keep it for future reference.

Important

Use only discs marked with logos listed on page 6.

Power Supply

The main power supply is engaged when the main plug is plugged in a 120V, 60Hz AC outlet. To operate the unit, press the **ON/STANDBY** button to turn on the unit.

Warning

To avoid fire or electric shock, do not expose this unit to rain or moisture.

WARNING:
LIVE PARTS INSIDE.
DO NOT REMOVE ANY SCREWS.

Installation Location

For safety and optimum performance of this unit:

- Do not stand the unit up vertically. Install the unit in a horizontal and stable position. Do not place anything directly on top of the unit. Do not place the unit directly on top of the TV.
- Shield it from direct sunlight and keep it away from sources of intense heat. Avoid dusty or humid places. Avoid places with insufficient ventilation for proper heat dissipation. Do not block the ventilation holes on the sides of the unit. Avoid locations subject to strong vibration or strong magnetic fields.
- Be sure to remove a disc and unplug the AC power cord from the outlet before carrying the unit.

Cautions on Installation

Noise or disturbance of the picture may be generated if this unit or any other electronic equipment using microprocessors is used near a tuner or TV.

If this happens, take the following steps:

- Install this unit as far as possible from the tuner or TV.
- Set the antenna wires from the tuner or TV away from this unit's power cord and input/output connection cords.
- Noise or disturbance tends to occur particularly when using indoor antennas or 300Ω/ohms feeder wires. We recommend using outdoor antennas and 75Ω/ohms coaxial cables.

NOTE:

- For heat dispersal, do not install this equipment in a confined space such as a book case or similar unit.

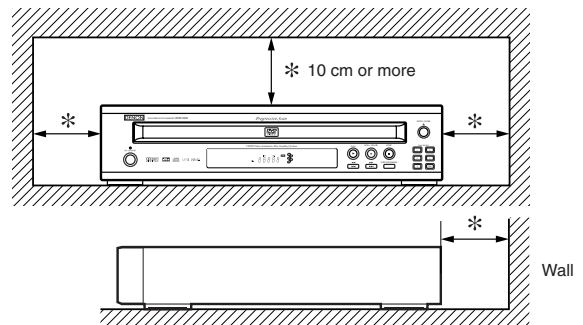

PRECAUTIONS

Dew Warning

Moisture condensation may occur inside the unit when it is moved from a cold place to a warm place, or after heating a cold room or under conditions of high humidity. Do not use the DVD Player at least for 2 hours until its inside is dry.

Avoid the Hazards of Electrical Shock and Fire

- Do not handle the power cord with wet hands.
- Do not pull on the power cord when disconnecting it from AC wall outlet. Grasp it by the plug.
- If, by accident, water is spilled on this unit, unplug the power cord immediately and take the unit to our Authorized Service Center for servicing.

Caution

- 1) Do not attempt to open the cabinet. There are no parts you can service inside. Refer all servicing to qualified service personnel.
- 2) Slot and openings in the cabinet and at the side or bottom are provided for ventilation. To ensure reliable operation and to protect the unit from overheating these opening must not be blocked or covered. Avoid enclosed spaces such as book cases unless proper ventilation is provided.

- 3) Keep the unit away from the radiator heat sources.
- 4) Avoid using near strong magnetic fields.
- 5) Do not push objects of any kind into this through the cabinet slot as they could touch current carrying parts or short circuit parts resulting in a fire or electric shock.
- 6) Never spill liquid of any kind on this unit.
If liquid is spilled into the unit, consult qualified service engineer.
- 7) Use this unit in a horizontal (flat) position only.
- 8) This equipment is in Stand-by mode when it turns off whilst the power cord is connected.
- 9) Keep the set free from moisture, water and dust.
- 10) Handle the power cord carefully. Hold the plug when unplugging the code.
- 11) All the safety cautions and operating instructions should be read before the DVD player is operated.
- 12) Use caution not to pinch your finger in the disc slot.
- 13) Do not put heavy objects on the AC power cord.
- 14) Keep the AC power cord away from heat appliances.
- 15) Be sure to remove a disc and unplug the AC power cord from the outlet before carrying the DVD player.
- 16) Do not put any pressure to the DVD player when carrying.
- 17) Do not use the DVD player outdoors.

TABLE OF CONTENTS

■ IMPORTANT SAFEGUARDS	2	Repeat	17
■ PRECAUTIONS	3	REPEAT TITLE / CHAPTER	17
■ INTRODUCTION	5	REPEAT TRACK	18
About Copyright	5	A-B REPEAT	18
Notice for the Progressive Scan Outputs	5	Program Playback (CD)	18
Supplied Accessories	5	Random Playback (CD)	18
Symbols Used in this Manual	5	MP3 / JPEG / WMA Playback	19
■ ABOUT THE DISCS	6	Slide Show Mode (JPEG)	20
Playable Discs	6	On-Screen Information	20
■ FEATURES	7	Track Selection	20
■ FUNCTIONAL OVERVIEW	8	Random Playback (MP3 / JPEG / WMA)	20
FRONT PANEL	8	Program Playback (MP3 / JPEG / WMA)	21
REMOTE CONTROL	8	Audio Language	21
Tour of the remote control	9	Stereo Sound Mode	21
Display	11	Subtitle Language	22
Displays During Operation	11	Camera Angle	22
Loading the Batteries	11	Changing the On-Screen Display	22
■ HOOK UPS	12	Marker Setup Screen	23
Description - rear panel	12	Black Level Setting	23
Connection to an audio system	13	Virtual Surround	23
Connection to a TV (for video)	14	■ DVD SETUP	24
■ PLAYING A DISC	15	Language Setting	24
Basic Playback	15	Display Setting	24
General Features	15	Audio Setting	25
Brightness of the Front Display	15	Ratings Control	25
Pause	15	RATING LEVEL	25
Disc Menus	15	IF YOU FORGET THE PASSWORD	25
Title Menu	15	CONTROL LEVELS	25
CALLING UP A MENU SCREEN DURING		■ MAINTENANCE	27
PLAYBACK	15	■ TROUBLESHOOTING GUIDE	28
Step by Step Playback	15	■ SPECIFICATIONS	29
Resume	16		
Fast Forward / Reverse Search	16		
Slow Forward / Slow Reverse	16		
Zoom	16		
Track Search	17		
Title / Chapter Search	17		
Time Search	17		

INTRODUCTION

The serial number of this product may be found on the back of the DVD player. No others have the same serial number as yours. You should record the number and other vital information here and retain this book as a permanent record of your purchase to aid identification in case of theft. Serial numbers are not kept on file.

Date of Purchase	
Dealer Purchase from	
Dealer Address	
Dealer Phone No.	
Model No.	
Serial No.	

About Copyright

Unauthorized copying, broadcasting, public performance and lending of discs are prohibited. This product incorporates copyright protection technology that is protected by U.S. patents and other intellectual property rights. Use of this copyright protection technology must be authorized by Macrovision, and is intended for home and other limited viewing uses only unless otherwise authorized by Macrovision. Reverse engineering or disassembly is prohibited.



Apparatus Claims of U. S. Patent Nos, 4,631,603, 4,577,216, 4,819,098, and 4,907,093 licensed for limited viewing uses only.

Notice for the Progressive Scan Outputs

Consumers should note that not all high definition television sets are fully compatible with this product and may cause artifacts to be displayed in the picture. In case of picture problems with 525 progressive scan output, it is recommended that the user switch the connection to the 'standard definition' output. If there are questions regarding your TV set compatibility with this 525p DVD player, please contact our customer service center.

Supplied Accessories

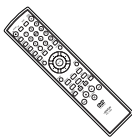
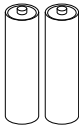
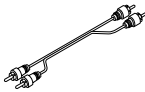
Please check to make sure the following items are included with the main unit in the carton.

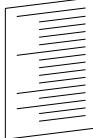
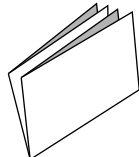
Remote control..... 1 	"AA" (R6P) batteries....2 	Audio cable 1 	Video cable..... 1 	Operating Instructions.. 1 	Service Station List..... 1 	Warranty Card 1 
--	--	--	---	---	---	--

Symbols Used in this Manual

The following symbols appear below in some headings and notes in this manual, with the following meanings.

DVD	:	Description refers to playback of DVD-Video discs. (including DVD-R/RW discs)
CD	:	Description refers to playback of Audio CDs.
MP3	:	Description refers to playback of discs formatted with MP3.
JPEG	:	Description refers to viewing of JPEG discs.
WMA	:	Description refers to playback of discs formatted with WMA.

A NOTE ABOUT RECYCLING

This product's packaging materials are recyclable and can be reused. Please dispose of any materials in accordance with your local recycling regulations.

Batteries should never be thrown away or incinerated but disposed of in accordance with your local regulations concerning chemical wastes.



Make your contribution to the environment!!!

- Used up batteries do not belong in the dust bin.
- You can dispose of them at a collection point for used up batteries or special waste. Contact your council for details.

ABOUT THE DISCS

Playable Discs

Playable discs	Mark (logo)	Region code	Recorded signals	Disc size	Disc types
DVD-Video * 1, 2, 3, 5					
DVD-RW DVD-R * 1, 3, 4, 5, 6, 7, 8	 	or	Digital video (MPEG2)	12 cm or 8 cm	
Audio CD * 3, 5		—	Digital audio		
CD-RW CD-R * 3, 4, 5, 7, 8	 	—	Digital audio MP3 WMA*9 Digital picture (JPEG)	12 cm or 8 cm	
Picture CD * 3, 4, 5, 7, 8		—	JPEG	12 cm	



is a trademark of DVD Format/Logo Licensing Corporation.



is trademark of Eastman Kodak Company.



Windows Media and the Windows logo are trademarks or registered trademarks of Microsoft Corporation in the United States and/or other countries.

If you cannot play back a disc which bears one of the marks above, check the following notes.

- *1: This unit conforms to the NTSC color system. Discs recorded in other color systems such as PAL cannot be played back.
- *2: Certain DVD discs do not operate as described in this manual due to the intentions of the disc's producers.
- *3: Scratched or stained discs may not be played back.
- *4: Some discs cannot be played back because of incompatible recording conditions, characteristics of the recorder or special properties of discs.
- *5: You can play back discs which bear the marks above. If you use nonstandardized discs, this unit may not play them back. Even if they are played back, the sound or video quality will be compromised.
- *6: Only the discs recorded in the video format and finalized can be played back. Unfinalized discs cannot be played back. Depending on the recording status of a disc, the disc may not be played back at all or normally (the picture or sound may be distorted, etc.).
- *7: If there is too much recording space left on a disc (the used portion is less than 55mm across), it may not play back properly.
- *8: Do not glue paper or put stickers on to the disc. These may damage the disc, and the unit may not read it correctly.
- *9: This player cannot play the disc contents protected by Windows Media Digital Rights Management (DRM).

- **NEVER play back the following discs. Otherwise, malfunction may result!**
DVD-RAM / CD-i / Photo CD / Video CD / DVD with region codes other than 1 or ALL / DVD-ROM for personal computers / CD-ROM for personal computers

- **On the following disc, the sound MAY NOT be heard.**

Super Audio CD

NOTES:

- Only the sound recorded on the normal CD layer can be delivered.
- The sound recorded on the high density Super Audio CD layer cannot be delivered.
- Any other discs without compatibility indications

CAUTION:

- Use caution not to pinch your finger in the disc slot.
- Be sure to remove a disc and unplug the AC power cord from the outlet before carrying the DVD player.

- **Progressive Scan system**
Unlike conventional interlace scanning, the progressive scan system provides less flickering and images in higher resolution than that of traditional television signals.
- **Dolby Digital sound**
This player can handle Dolby Digital surround sound having Multi-channels when connected to a Dolby Digital decoder.
- **Still/fast/slow/step playback**
Various playback modes are available including still pictures, fast forward/reverse, slow motion and step frames.
- **Random playback for Audio CD, MP3, JPEG, and WMA**
This player can shuffle the order of tracks to play them in random order.
- **Program playback for Audio CD, MP3, JPEG, and WMA**
You can program the order of tracks to play them in any desired order.
- **DVD menus in a desired language**
You can display DVD menus in a desired language, if available on a DVD.
- **Auto standby**
When the screen saver program is activated for 35 minutes, the power is automatically turned off.
- **Subtitles in a desired language**
You can select a desired language for the display subtitles if that language is available on a disc.
- **Selecting a camera angle**
You can select the desired camera angle if a disc contains sequences recorded from different angles.
- **Choices for audio language and sound mode**
You can select the desired audio language and sound mode if different languages and modes are available on a disc.
- **Parental lock**
You can set the control level to limit playback of discs which may not be suitable for children.
- **Automatic detection of discs**
This player automatically detects if a loaded disc is DVD-Video, Audio CD, MP3, JPEG, or WMA.
- **Playing an MP3 disc**
You can enjoy MP3 files which are recorded on CD-R/RW.
- **Direct Search**
You can search the desired title, chapter, and track with the numeric buttons during playback or in stop mode.
- **On-screen display**
Information about the current operation can be displayed on a TV screen, allowing you to confirm the currently active functions (such as program playback), using the remote control.
- **DTS (Digital Theater System)**
When this player is connected to a DTS decoder, you can enjoy 5.1channel surround system developed by the Digital Theater Systems, Inc. which reproduces the original sound as truthfully as possible.
- **Search**
Chapter search: Search for the chapter designated by user is possible.
Title search: Search for the title designated by user is possible.
Track search: Search for the track designated by user is possible.
Time search: Search for the time designated by user is possible.
- **Repeat**
Chapter: Repeated playback of the chapter of the disc being played is possible.
Title: Repeated playback of the title of the disc being played is possible.
Track: Repeated playback of the track of the disc being played is possible.
Disc (Audio CD): Repeated playback is possible.
(MP3/JPEG/WMA): Repeated playback is possible.
A-B: The part between A and B designated by user is possible.
Group: Repeated playback of the folder of the MP3/JPEG/WMA disc being played is possible.
5 Disc: Repeated playback of Audio CD/MP3/ JPEG/ WMA discs is possible.
- **Zoom**
2-time or 4-time magnified screen can be displayed.
- **Marker**
The part designated by user can be called back.
- **Resume playback**
User can resume playback from the part at which the play was stopped even if the power is turned off.
- **Component Video Out Jacks**
Jacks located on the back of the DVD Player which are used to send high-quality video to a TV via Component Video In Jacks.
- **Dimmer**
Brightness of the display can be varied.
- **Bit rate indication**
- **DRC (Dynamic range control)**
You can control the range of sound volume.
- **Displaying a JPEG picture**
Kodak Picture CD can be played. Still images stored in JPEG format on CD-R/RW can also be played.
- **Reproducing WMA data**
You can enjoy WMA files which are recorded on CD-R/RW.

“WMA” (Windows Media Audio) is an audio codec developed by Microsoft® in the United States of America.

FUNCTIONAL OVERVIEW

FRONT PANEL

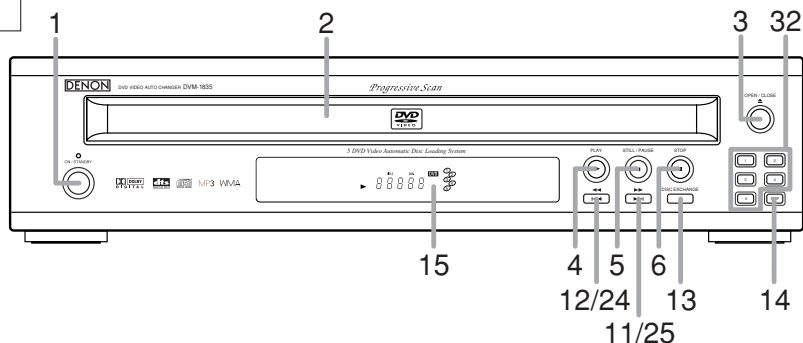

REMOTE CONTROL

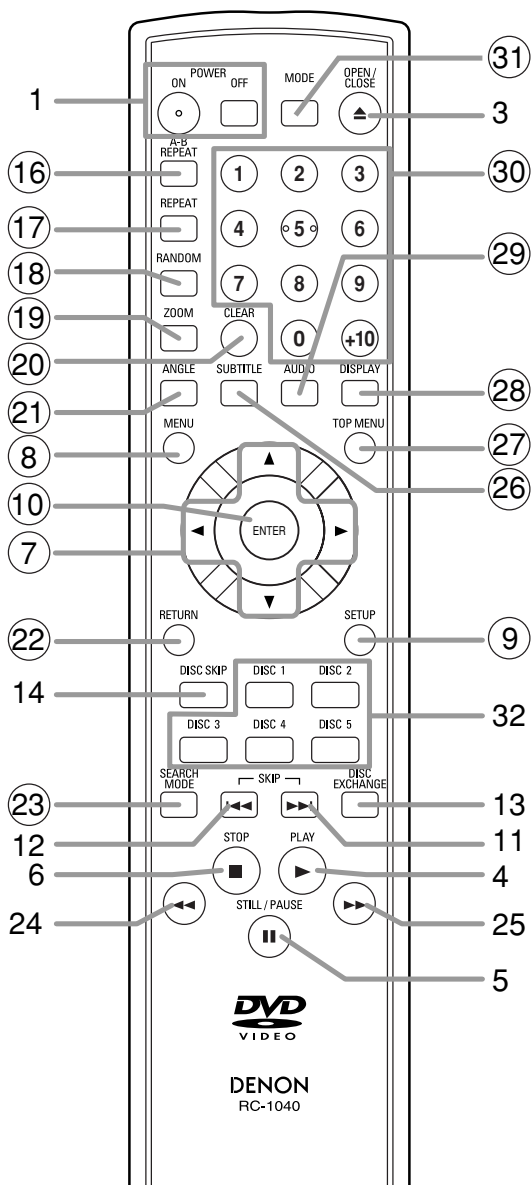















1. **ON/STANDBY, (POWER ON/OFF) Buttons** [page 15]
2. **Disc loading tray**
3. **OPEN/CLOSE Button** [page 15]
4. **PLAY Button** [page 15]
5. **STILL/PAUSE Button** [page 15]
6. **STOP Button** [page 15]
7. **Cursor Buttons** [page 15]
Use when making settings while watching the display on a TV screen.
8. **MENU Button** [page 15]
9. **SETUP Button** [page 24]
10. **ENTER Button** [page 15]
11. **▶▶(SKIP) Button** [page 17]
Plays back from the beginning of the next chapter or track.
12. **◀◀(SKIP) Button** [page 17]
Plays back from the beginning of the current chapter or track.
13. **DISC EXCHANGE Button** [page 15]
Press to change discs during playback.
14. **DISC SKIP Button** [page 15]
Press to select a desired disc or disc tray.
15. **Display, Remote Sensor Window**
16. **A-B REPEAT Button** [page 18]
17. **REPEAT Button** [page 17]
18. **RANDOM Button** [page 18,20]
19. **ZOOM Button** [page 16]
20. **CLEAR Button** [page 17]
21. **ANGLE Button** [page 22]
Press to change the camera angle to see the sequence being played back from a different angle.
22. **RETURN Button** [page 21]
23. **SEARCH MODE Button** [page 17]
24. **◀◀(Fast Reverse SEARCH) Button** [page 16]
Press more than 2 seconds when you use the front panel button for this function.
25. **▶▶(Fast Forward SEARCH) Button** [page 16]
Press more than 2 seconds when you use the front panel button for this function.
26. **SUBTITLE Button** [page 22]
Press to select a desired subtitle language.
27. **TOP MENU Button** [page 15]
28. **DISPLAY Button** [page 20]
29. **AUDIO Button** [page 21]
Press to select a desired audio language or sound mode.
30. **Numeric Buttons** [page 17]
31. **MODE Button** [page 20]
32. **DISC NUMBER Buttons** [page 15]
Press to select a desired disc or disc tray directly.

The buttons with circled numbers can only be operated with the remote control.

FUNCTIONAL OVERVIEW













Tour of the remote control

Buttons on remote control work in different ways for DVD, Audio CD, MP3, JPEG and WMA :
Refer to the following table for correct use.

	DVD	CD/MP3/JPEG/WMA
POWER Buttons 	<ul style="list-style-type: none"> To switch the power between on and standby. 	<ul style="list-style-type: none"> To switch the power between on and standby.
A-B REPEAT Button 	<ul style="list-style-type: none"> To mark a segment between A and B for repeated playback. 	<ul style="list-style-type: none"> To mark a segment between A and B for repeated playback. (CD)
REPEAT Button 	<ul style="list-style-type: none"> To repeat playback of a title or chapter. 	<ul style="list-style-type: none"> To repeat playback of a track or disc. (CD) To repeat playback of a track, group or disc. (MP3, JPEG, WMA)
RANDOM Button 	—	<ul style="list-style-type: none"> To play back tracks in random order.
MODE Button 	<ul style="list-style-type: none"> To set black level on/off. To activate the 3D sound (Virtual surround system). 	<ul style="list-style-type: none"> To program a specific playback order. To activate the 3D sound (Virtual surround system). (CD, MP3, WMA)
ZOOM Button 	<ul style="list-style-type: none"> To magnify part of the picture (x2/x4). 	—
ANGLE Button 	<ul style="list-style-type: none"> To access various camera angles on the disc. 	—
SUBTITLE Button 	<ul style="list-style-type: none"> To access various subtitles on the disc. 	—
AUDIO Button 	<ul style="list-style-type: none"> To access various audio functions on the disc. 	<ul style="list-style-type: none"> To select STEREO, L-CH or R-CH. (CD)
DISPLAY Button 	<ul style="list-style-type: none"> To display the current disc mode. 	<ul style="list-style-type: none"> To display the current disc mode.
SEARCH MODE Button 	<ul style="list-style-type: none"> To search for a chapter, title, time or marker. To return to a location on the disc rapidly. 	<ul style="list-style-type: none"> To search for a track. To search for time or a marker. (CD) To return to a location on the disc rapidly.
OPEN/CLOSE Button 	<ul style="list-style-type: none"> To open or close the disc tray. 	<ul style="list-style-type: none"> To open or close the disc tray.
NUMERIC Buttons 	<ul style="list-style-type: none"> To select a chapter or title directly. 	<ul style="list-style-type: none"> To select a track directly.
CLEAR Button 	<ul style="list-style-type: none"> To clear the markers. To clear the numbers entered incorrectly. To cancel the A point for A-B Repeat. 	<ul style="list-style-type: none"> To clear the markers. (CD) To clear the numbers entered incorrectly. To cancel the A point for A-B Repeat. (CD)

FUNCTIONAL OVERVIEW

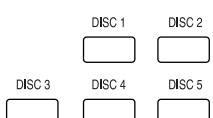
Tour of the remote control

	DVD	CD/MP3/JPEG/WMA
MENU Button 	<ul style="list-style-type: none"> To call up the menu on a disc. 	—
TOP MENU Button 	<ul style="list-style-type: none"> To call up the top menu on a disc. 	—
ENTER, CURSOR Buttons 	<ul style="list-style-type: none"> To move the cursor and determine its position. 	<ul style="list-style-type: none"> To move the cursor and determine its position.
RETURN Button 	<ul style="list-style-type: none"> To return to the previous operation in the setup menu. 	<ul style="list-style-type: none"> To return to the previous operation in the setup menu.
SETUP Button 	<ul style="list-style-type: none"> To call up the setup menu. 	<ul style="list-style-type: none"> To call up the setup menu.
SKIP Buttons 	<ul style="list-style-type: none"> To skip chapters/titles. 	<ul style="list-style-type: none"> To skip tracks.
SEARCH Buttons 	<ul style="list-style-type: none"> To begin fast forward/reverse search or slow forward/slow reverse. 	<ul style="list-style-type: none"> To begin fast forward/reverse search. (CD, MP3, WMA)
STOP Button 	<ul style="list-style-type: none"> To stop playback. 	<ul style="list-style-type: none"> To stop playback.
PLAY Button 	<ul style="list-style-type: none"> To begin playback. 	<ul style="list-style-type: none"> To begin playback.
STILL/PAUSE Button 	<ul style="list-style-type: none"> To pause playback. To advance playback frame by frame. 	<ul style="list-style-type: none"> To pause playback.
DISC SKIP Button 	<ul style="list-style-type: none"> To select a desired disc. 	<ul style="list-style-type: none"> To select a desired disc.
DISC NUMBER Buttons 	<ul style="list-style-type: none"> To select a desired disc directly. 	<ul style="list-style-type: none"> To select a desired disc directly.
DISC EXCHANGE Button 	<ul style="list-style-type: none"> To change discs during playback. 	<ul style="list-style-type: none"> To change discs during playback.

Display

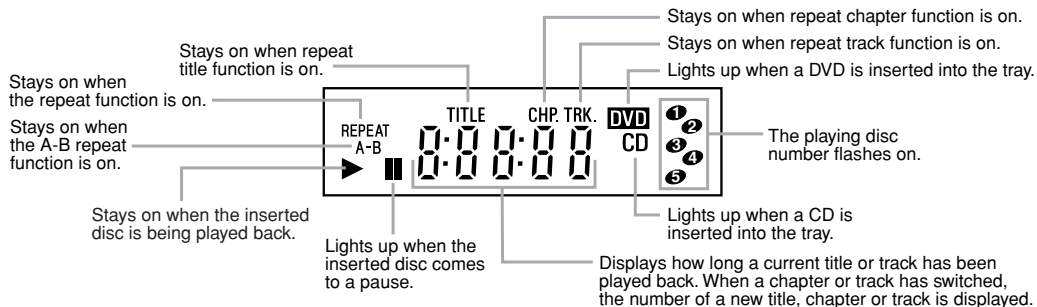

Displays During Operation

	Power on
	No disc inserted
	Tray open
	Tray closed
	Loading the Disc
	Power off
	Tray rotation
	AC cord plugged in

Loading the Batteries

1. Open the battery compartment cover.
2. Insert two "AA" (R6P) batteries, with each one oriented correctly.
3. Close the cover.

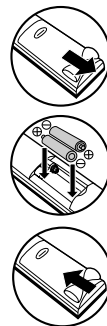

NOTES

- Do not mix alkaline and manganese batteries.
- Do not mix old and new batteries.

Cautions On Batteries

- Use "AA" (R6P) batteries in this remote control unit.
- Replace the batteries with new ones approximately once a year, though this depends on the frequency with which the remote control unit is used.
- If the remote control unit does not operate close to the main unit, replace the batteries with new ones, even if less than a year has passed.
- The included batteries serve only for verifying operation. Replace them with new batteries as soon as possible.
- When inserting the batteries, be careful to do so in the proper direction, following the ⊕ and ⊖ marks in the remote control unit's battery compartment.
- To prevent damage or battery fluid leakage:
 - Do not use a new battery with an old one.
 - Do not use two different types of batteries.
 - Do not short-circuit, disassemble, heat or dispose of batteries in flames.
- Remove the batteries when not planning to use the remote control unit for a long period of time.
- If the batteries should leak, carefully wipe off the fluid from the inside of the battery compartment, then insert new batteries.

Description - rear panel

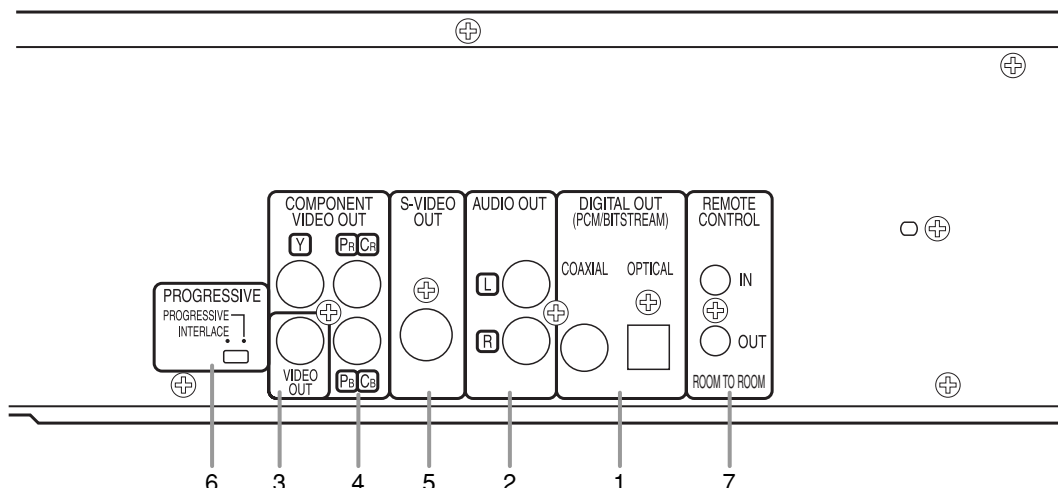

1. DIGITAL OUT JACKS

Use either an optical or coaxial digital cable to connect to a compatible Dolby Digital receiver. Use to connect to a Dolby Digital decoder or DTS decoder.

2. AUDIO OUT JACKS

Connect to the Audio input jacks of A/V-compatible TV or wide screen TV, or Stereo system.

3. VIDEO OUT JACK

Use a video cable to connect one of the jack to Video input on your A/V-compatible TV or wide screen TV, or Stereo system.

4. COMPONENT VIDEO OUT JACKS

Use these jacks if you have a TV with Component Video in jacks. These jacks provide Cr/P_R, Cb/P_B and Y video. Along with S-Video, Component Video provides the best picture quality.

5. S-VIDEO OUT JACK

Use the S-Video cable to connect this jack to the S-Video jack on your A/V-compatible TV or wide screen TV for a higher quality picture.

6. PROGRESSIVE switch

7. REMOTE CONTROL JACKS

Connecting the DENON Satellite Remote Control to these jacks enables you to operate more than one DENON components with one remote control.

When using the DENON Satellite Remote Control,

1. Connect the DENON Satellite Remote Control to the REMOTE CONTROL IN jack of this player. This allows you to operate this player with the Satellite Remote Control.
2. Connect another DENON component to the REMOTE CONTROL OUT jack of this player. This allows you to operate this player and the connected component with the same Satellite Remote Control.

Selecting Progressive Scan (525p/480p or Interlaced 525i/480i) Playback

- If your TV is compatible with progressive scanning (525p/480p), connect the TV to the COMPONENT VIDEO OUT jacks of the DVD player and set the Progressive switch on the back of the DVD player to "PROGRESSIVE". Next, set your TV to the progressive scan mode.

If your TV is not compatible with progressive scan, keep the Progressive switch to "INTERLACE".

- Use a commercially available adaptor if the video input jacks of your TVs or monitors are the BNC type.

What is Progressive Scanning?

- Unlike conventional interlace scanning, the progressive scan system provides less flickering and images in higher resolution than that of traditional (525i/480i) television signals.

NOTE

- When the Progressive switch is set to "PROGRESSIVE", no video signal will be output from the VIDEO OUT or S-VIDEO OUT jack.

Manufactured under license from Dolby Laboratories. "Dolby" and the double-D symbol are trademarks of Dolby Laboratories.

"DTS" and "DTS Digital Out" are trademarks of Digital Theater Systems, Inc.

HOOK UPS

The following show examples of connections commonly used to connect the DVD player to TV and other components. If using this DVD player to play back a DVD in a Dolby Digital Multi-channel surround or DTS surround format, the DVD player outputs a Dolby Digital or DTS data stream from its OPTICAL or COAXIAL DIGITAL OUT jacks. By hooking up the player to a Dolby Digital or DTS decoder, you can enjoy more convincing, realistic ambience with powerful and high-quality surrounding sound of a professional standard which can be heard in movie theaters. Use a commercially available audio optical or coaxial digital cable (not included) for the audio connections.

Notes

- Be sure to turn off the power to all components in the system before connecting another component.
- Refer to the Instruction Manuals for your TV, stereo system and any other components to be connected to the DVD player.

Connection to an audio system

Method 1

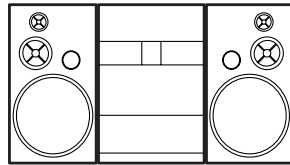

Stereo system

Method 2

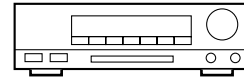

Dolby Digital decoder
or
DTS decoder

AUDIO

Audio Input Jacks

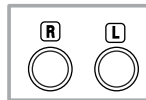

Audio cable
(supplied)

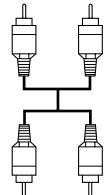

Digital Audio Input
Jacks

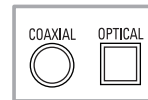

Audio Coaxial
Digital cable
(commercially
available)

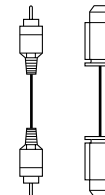

Optical cable
(commercially
available)

DVD

AUDIO OUT
(analog)

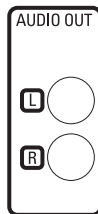

DIGITAL OUT

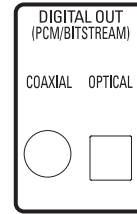

- **Method 1** DVD Player + Stereo system
- **Method 2** DVD Player + Dolby Digital decoder or DTS decoder

NOTES

- If output Dolby Digital audio, connect to a Dolby Digital decoder, and set Dolby Digital to ON for audio output in the setup mode. (Refer to page 25)
- If output DTS audio, connect to a DTS decoder, and set DTS to ON for audio output in the setup mode. (Refer to page 25)
- Unless connected to a Dolby Digital decoder, or a DTS decoder, set Dolby Digital or DTS to OFF for audio output in the setup mode. Playing a DVD using incorrect settings may generate noise distortion, and may also damage the speakers. (Refer to page 25)
- The audio source on a disc in a Dolby Digital Multi-channel surround format cannot be recorded as digital sound by an MD or DAT deck.
- Set Dolby Digital and DTS to OFF for audio output in the setup mode for method 1 only. Playing a DVD using incorrect settings may generate noise distortion, and may also damage the speakers. (Refer to page 25)
- Harsh noise that could harm your ears or the speakers is generated when a DVD recorded in DTS is played while using a decoder, etc., that is not DTS-compatible.
- When playing a copyright-protected 96kHz PCM DVD, the digital sound will be down sampled at 48kHz, even if you set "LPCM SELECT" to "OFF" (Refer to page 25).

Optical cable (not supplied)

- Optical cable (not supplied) may be damaged when bent at sharp angles. Ensure cables are coiled in loops with a diameter of 6 inches (15 cm) or more when storing them.
- Use a cable which is 9.8 feet (3 m) or shorter.
- Insert cable plugs firmly into the connectors when making connections.
- If a plug has dust or is dirty, clean it with a soft cloth before inserting it into a connector.

Connection to a TV (for video)

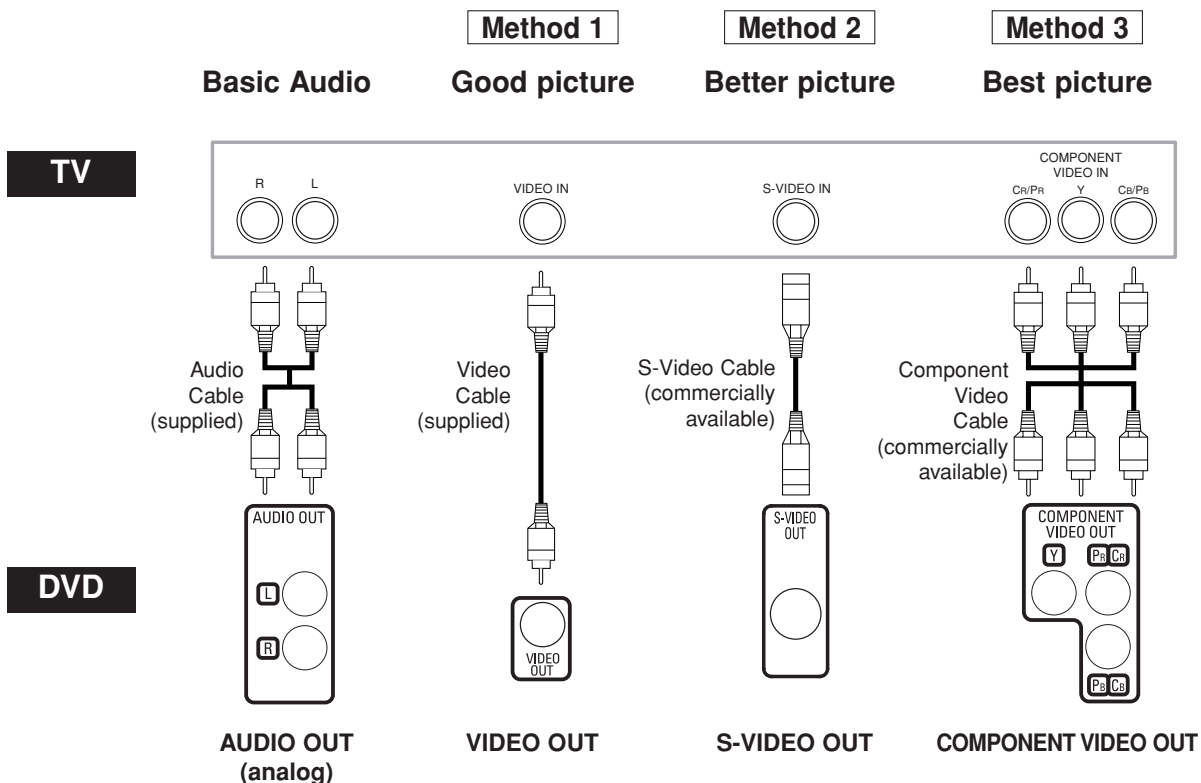

- **Method 1** DVD Player + TV with Video Input Jack
- **Method 2** DVD Player + TV with S-Video Input Jack
- **Method 3** DVD Player + TV with Component Video Jacks

NOTES

- If your TV is compatible with progressive scanning (525p/480p), connect the TV to the Component Video Output jacks of the DVD player. Refer to page 12.
- Connect the DVD player directly to a TV. If the Audio/Video cables are connected to a VCR, pictures may be distorted due to the copy protection system.
- S-Video output connector
The video signals are divided into color (C) and brightness (Y) signals, achieving a clearer picture.
If the TV is equipped with a S-Video input connector, we recommend connecting it to the this product's S-Video output connector using a commercially available S-Video connection cord.

HOW TO CONNECT TO A TV WITHOUT AUDIO/VIDEO INPUT JACKS

If your TV does not have RCA type audio and video input jacks it is still possible to connect this DVD player to your TV's 75-ohm coaxial antenna terminal using an optional Stereo Audio/Video RF Modulator, not included. Connect the audio and video outputs of the DVD player to the audio and video inputs on the RF Modulator, and then connect the coaxial output of the RF Modulator (usually marked "TO TV") to the 75 ohm coaxial antenna terminal on your TV. Follow the instruction supplied with the RF Modulator for more details.

If your TV's 75 ohm coaxial antenna terminal is already occupied by an antenna or cable box connection, remove that cable from your TV's antenna terminal and reconnect it to the coaxial antenna input terminal of the RF Modulator (usually marked "ANT IN"), then connect the RF modulator to your TV's antenna terminal as described above.

NOTE

- The picture quality from DVD discs will not be as good if the DVD player is connected to the TV's antenna terminal through an RF Modulator.

PLAYING A DISC

Basic Playback

DVD CD MP3 JPEG WMA

Getting started

- Turn on the power of the TV, amplifier and any other components which are connected to the DVD player.
- Make sure the TV and audio receiver (commercially available) are set to the correct channel.

- 1 Press the **POWER ON** button.
 - "P-ON" will appear briefly on the display panel.
- 2 Press the **OPEN/CLOSE** button to open disc loading tray.
- 3 Press the **DISC SKIP** button repeatedly or press the **DISC NUMBER** button.
 - The desired disc tray moves to the front position.
- 4 Place the disc in the tray, with the label facing up.
 - Repeat steps 3 and 4 to load more discs.

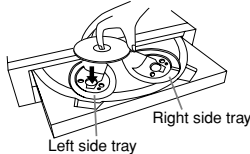

- 5 Press the **PLAY** button.
 - The tray will close automatically, and playback will start from the first chapter or track of the disc. If the playback does not start automatically, press the **PLAY** button.
 - If the disc has not been set on the tray, the DVD player will play the disc which is set on the right side tray.
 - When you want to select the other disc, press the **DISC SKIP** button repeatedly or the **DISC NUMBER** button for your desired disc.
 - When you playback the DVD with a title menu, it may appear on the screen. In this case, refer to "Title Menu".
- 6 Press the **STOP** button to stop playback.

NOTES:

- A "prohibited icon" may appear at the top-right on the TV screen during operation, warning that a prohibited operation has been encountered by the DVD player or the disc.
- With DVDs that use some titles for playback program signals, playback may start from the second title, or it may skip these titles.
- During the playback of two layered disc, pictures may stop for a moment. This happens when the 1st layer switches to the 2nd layer. This is not a malfunction.
- During the playback of a DVD-RW which has been recorded in the VR mode, the sound or picture may freeze momentarily depended on disc content.
- You can open the tray and change 2 discs during playback by pressing the **DISC EXCHANGE** button.
- Disc position will be displayed on the TV screen for about 5 minutes when you turn on the power or close the tray.



General Features

DVD

DVD may contain menus to navigate the disc and access special features. Press the appropriate **Numeric** buttons or use the **Cursor** buttons (▼/▲/▶/◀) to highlight your selection in the DVD main menu and press the **ENTER** button to confirm.

NOTE:

- Unless stated, all operations described are based on remote control use. Some operations can be carried out using the menu bar on the TV screen.

Brightness of the Front Display

The brightness of the front display can be adjusted from the **SETUP** menu. Details are on page 24.

Pause

DVD CD MP3 JPEG WMA

- 1 During playback, press the **STILL/PAUSE** button.
 - Playback will pause and sound will be muted.



- 2 To continue playback, press the **PLAY** button.

Disc Menus

DVD

- 1 Press the **MENU** button.
 - The DVD main menu will appear.
- 2 If the feature is not available, a prohibited icon (a circle with a diagonal line) may appear on the TV screen.
- 3 If disc menu is available on the disc, audio language, subtitle options, chapters for the title and other options will appear for selection.
- 4 Press the **Cursor** buttons (▼/▲/▶/◀) to select an item, and the **ENTER** button to confirm selection.

Title Menu

DVD

- 1 Press the **TOP MENU** button.
 - The title menu will appear.
- 2 If the feature is not available, a prohibited icon (a circle with a diagonal line) may appear on the TV screen.
- 3 Press the **Cursor** buttons (▼/▲/▶/◀) to select an item, and the **ENTER** button to confirm the selection.
 - Playback will begin at the selected Title.

CALLING UP A MENU SCREEN DURING PLAYBACK

- Press the **MENU** button to call up the DVD main menu.
- Press the **TOP MENU** button to call up the title menu.

NOTE:

- Contents of menus and corresponding menu operations may vary between discs. Refer to the manual accompanying the disc for details.

Step by Step Playback

DVD

- 1 During playback, press the **STILL/PAUSE** button.
 - Playback will pause and sound will be muted.



- 2 The disc advances by one frame each time the **STILL/PAUSE** button is pressed.
- 3 To exit step by step playback, press the **PLAY** button.

PLAYING A DISC

Resume

DVD CD MP3 JPEG WMA

- During playback, press the **STOP** button.
 - Resume message will appear on the TV screen.

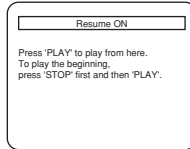

- Press the **PLAY** button, playback will resume from the point at which playback was stopped.
 - To cancel resume, press the **STOP** button twice.

NOTES:

- The resume playback takes a little longer to take place compared to the normal playback.
- For MP3, JPEG or WMA, playback will resume from the beginning of the current track.

Fast Forward / Reverse Search

DVD CD MP3 WMA

- During playback, press the **▶▶** or **◀◀** button repeatedly to select the required forward or reverse speed: x2, x8, x50, x100.
 - For Audio CDs, the speed is fixed at x16.
 - For MP3 and WMA the speed is fixed at x8.

◀◀ Button

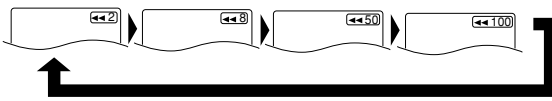

- To return to normal playback, press the **PLAY** button.

Slow Forward / Slow Reverse

DVD

- During playback, press the **STILL/PAUSE** button.
- Press the **▶▶** or **◀◀** button.
 - Slow motion playback will begin and sound will be muted.
- Press the **▶▶** or **◀◀** button repeatedly to select the required speed: 1/16, 1/8, 1/2 of the normal playback.
- To return to normal playback, press the **PLAY** button.

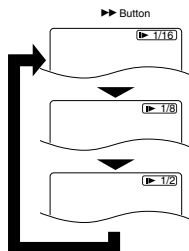

Zoom

DVD

The Zoom function allows you to enlarge the video image and to pan through the enlarged image.

- Press the **ZOOM** button during playback.
 - Playback will continue.
- Press the **ZOOM** button repeatedly to select the required zoom factor: x2, x4 or OFF.



- Use the **Cursor** buttons (▼/▲/▶/◀) to move the zoomed picture across the screen.

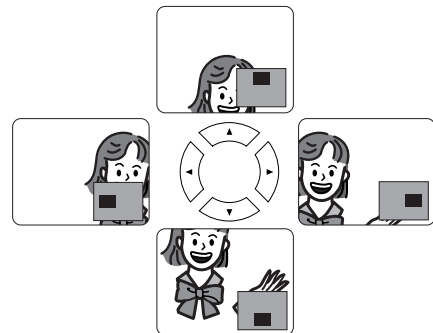

- To exit zoom mode, press the **ZOOM** button to OFF.

NOTES:

- Zooming function does not work while disc menu is shown.
- x4 zoom is not available on some discs.

PLAYING A DISC

Track Search

CD **MP3** **JPEG** **WMA**

There are three ways to begin playback on an Audio CD, MP3, JPEG or WMA disc at a specific track.

By using the Numeric buttons

- 1 Press the **Numeric** buttons to enter the desired track number.
 - Playback will start at the selected track.
 - For single digit tracks (1-9), press a single number (eg. track 3, press **3**).
 - To play track 26, press **+10, 2, 6**.

By using the SEARCH MODE button

CD

- 1 Press the **SEARCH MODE** button.
 - The track search display appears.

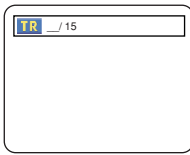

- 2 Within 30 seconds, select a desired track number using the **Numeric** buttons. For single digits press **0** first.
 - Playback will start at the selected track.
 - Press the **CLEAR** button to erase the incorrect input.

By using the SKIP buttons **◀◀▶▶**

During playback, press the **SKIP ▶▶** button to move to the next track. Press it repeatedly to skip subsequent tracks. Press the **SKIP ◀◀** button to go back to the beginning of the current track. Press it repeatedly to go to the previous tracks.

- Track number will appear briefly on the front display panel.
- If any **SKIP** button is pressed while the playback is paused, the playback will be paused again after skipping to the next track.

- NOTE:**
- The **SKIP ◀◀** and **▶▶** buttons are not available when playback is stopped.

Title / Chapter Search

DVD

By using the SEARCH MODE button

- 1 Press the **SEARCH MODE** button for the title/chapter search.



- 2 Enter the desired title/chapter number with the **Numeric** buttons.

By using the SKIP buttons **◀◀▶▶**

During playback, press the **SKIP ▶▶** button to move to the next chapter. Press it repeatedly to skip to subsequent chapters. Press the **SKIP ◀◀** button to go back to the beginning of the current chapter. Press it repeatedly to go to the previous chapter.

- Chapter number will appear briefly on the front display panel.
- If the **SKIP ◀◀** or **▶▶** button is pressed while the playback is paused, the playback after skipping to the next chapter will be also paused.

NOTES:

- Depending on the disc being played, the **Numeric** buttons can be used to search for a desired chapter by entering the chapter number directly. Refer to the manual accompanying the disc.
- The **SKIP ◀◀** and **▶▶** buttons are not available when playback is stopped.
- A disc that does not contain chapters within titles, the **SKIP ◀◀** and **▶▶** buttons change the titles.

Time Search

DVD

- 1 During playback, press the **SEARCH MODE** button three times to display the Time Search on the TV screen.
- 2 Within 30 seconds, enter a desired disc time with the **Numeric** buttons.
 - Playback will start at the specified time.

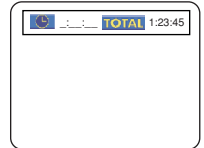

- 3 Press the **CLEAR** button to erase the incorrect input.

CD

- 1 During playback, press the **SEARCH MODE** button twice to display the Time Search on the TV screen.
- 2 Within 30 seconds, enter a desired disc time with the **Numeric** buttons.
 - Playback will start at the specified time.

- 3 Press the **CLEAR** button to erase the incorrect input.

Repeat

- The **REPEAT** button is available only during playback.

REPEAT TITLE / CHAPTER

DVD

To activate the repeat function, press the **REPEAT** button during playback.

- The repeat mode changes as described below every time you press the button.

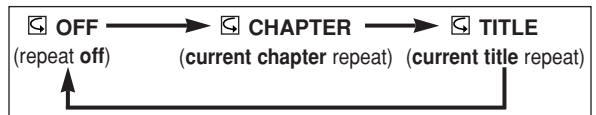

NOTES:

- Repeat title/chapter is not available with some scenes.
- The repeat setting will be cleared when moving to other title or chapter.
- Repeat playback does not function during A-B repeat playback.

PLAYING A DISC

REPEAT TRACK

CD

To activate the repeat function, press the **REPEAT** button during playback.

- The repeat mode changes as described below every time you press the button.

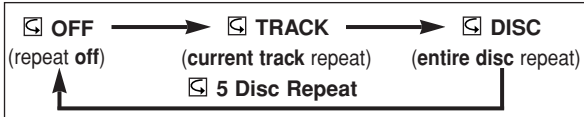

NOTES:

- The repeat setting will be cleared when moving to other track.
- Repeat playback does not function during A-B repeat playback.

MP3 JPEG WMA

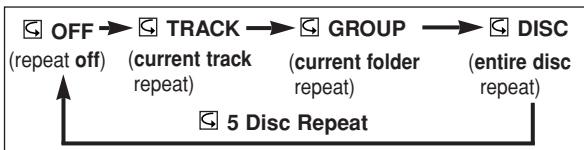

- The repeat setting will be cleared when moving to other track or group.

A-B REPEAT

DVD CD

- Press the **A-B REPEAT** button at your chosen starting point.

- A-** appears briefly on the TV screen.

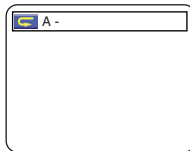

- Press the **A-B REPEAT** button again at your chosen end point.

- A-B** appears briefly on the TV screen, and the repeat sequence begins.

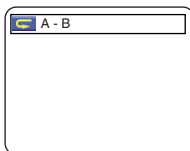

- To exit the sequence, press the **A-B REPEAT** button.

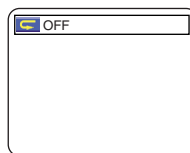

NOTES:

- The A-B repeat section can only be set within the current title (for DVDs), or current track (for Audio CDs).
- A-B repeat is not available with some scenes in DVD.
- To cancel the A point which was set, press the **CLEAR** button.
- A-B repeat playback does not function during title, chapter, track or all repeat playback.

Program Playback

CD

You may determine the order in which tracks will play.

- In stop mode press the **MODE** button.

- The PROGRAM screen will appear.

- Press the **Cursor** buttons (**▲** or **▼**) to select a disc, then press the **ENTER** button.

- Press the **CLEAR** button to erase the most recently entered program.

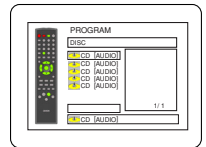

- Press the **Cursor** buttons (**▲** or **▼**) to select a track, then press the **ENTER** button.

- Press the **CLEAR** button to erase the most recently entered program.

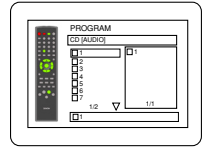

- Press the **PLAY** button to start programmed playback.

NOTES:

- Press the **STOP** button once and then the **PLAY** button again, playback will restart from the point where the **STOP** button was pressed. (Program continued)
- Press the **STOP** button twice and then the **PLAY** button again, playback will restart from the track in the usual way. (Program cleared)
- The program setting will be cancelled when the power is turned off or the disc tray is opened.
- Up to 99 tracks can be entered.
- If you wish to repeat the current track in the program, press the **REPEAT** button repeatedly until **TRACK** appears during playback. If you wish to repeat the entire program press the **REPEAT** button repeatedly until **DISC** appears during playback.
- If eight or more tracks were set in a program, use the **SKIP** **◀◀** or **▶▶** button to see all the tracks.
- Refer to page 21 for program playback of MP3, WMA, and JPEG.

Random Playback

CD

This shuffles the playing order of tracks instead of playback in the original sequence.

When playing back tracks in a single disc randomly

- In stop mode, press the **RANDOM** button once or press the **MODE** button twice.
- Press the **PLAY** button to start random playback.

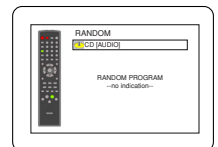

When playing back tracks in more than one discs randomly

- In stop mode, press the **RANDOM** button twice or press the **MODE** button three times.
- Press the **PLAY** button to start random playback.

NOTES:

- If there are discs other than CD in the disc tray, the display will show "----" next to the disc number. If there is no disc in a tray, this area will be blank.
- If you wish to repeat the current track in the random selection, press the **REPEAT** button repeatedly until **TRACK** appears during playback. If you wish to repeat the entire random selection, press the **REPEAT** button repeatedly until **DISC** appears during playback.
- You cannot go back to the previous track during random playback.
- Refer to page 20 for random playback of MP3, WMA, and JPEG.

MP3 / JPEG / WMA Playback

MP3

JPEG

WMA

This DVD player can reproduce images and sounds from data recorded in MP3, JPEG and WMA formats on CD-R and CD-RW discs.

The DVD player can also run JPEG files stored on Kodak Picture CD.

The user can enjoy picture images on the television set by reproducing Picture CDs.

* Picture CD is a service to convert a photograph taken by conventional film camera into digital data and write the data on a CD.

For details of Picture CD, contact a shop that deals with developing service of Kodak Inc.

This player recommends the use of files recorded at the following specifications:

Applicable MP3 file		Remarks
Sampling frequency	44.1kHz 48kHz	• It is prohibited to record MP3 sound on a digital device when connection is made digitally.
Type	MPEG1 audio layer 3	• MP3 files recorded at fixed bit rate of 112 kbps or higher are recommended.
Applicable JPEG file		Remarks
Size of image	Upper limit: 6300x5100 dots Lower limit: 32x32 dots	• A JPEG image that extends beyond the screen is reduced so that it will be displayed within the screen.
Applicable WMA file		Remarks
Sampling frequency	44.1kHz 48kHz	• Those frequencies are applicable to WMA version 8 only, not to WMA version 9.
Bit rate	48–192kbps	• Ensure that the copyright function is set to off when preparing a WMA disc.
Type	WMA version 8	• A prohibition “disable” symbol will appear if the user attempts to run a non-reproducible file such as copyright-protected.





Information on MP3, JPEG and WMA discs

- A file with an extension of “.mp3 (MP3)” is called an “MP3 file”.
- A file with an extension of “.jpg (JPG)” or “.jpeg (JPEG)” is called a “JPEG file”.
The DVD player can run an image file conforming to the Exif* specification.
- * This is a file format, Exchangeable Image File format established by Japanese Electronic Industry Development Association (JEIDA).
- A file with an extension of “.wma (WMA)” is called a “WMA file”.
- Files whose extension is other than “.mp3 (MP3)”, “.jpg (JPG)”, “.jpeg (JPEG)” or “.wma (WMA)” will not be listed on the MP3, JPEG, or WMA menu.
- If the file is not recorded in MP3, JPEG or WMA format, noise may be produced even if the file extension is either of “.mp3 (MP3)”, “.jpg (JPG)”, “.jpeg (JPEG)” or “.wma (WMA)”.

When a disc with MP3, JPEG or WMA files is inserted in the DVD player, the track menu will appear on the TV screen, and number of tracks is displayed on the front panel.

1 Place the disc in the tray with the label facing up.

For discs on which MP3, JPEG or WMA tracks are recorded:

- An MP3, JPEG or WMA track menu screen appears.
- A symbol of “” is shown on the top of the group name.
- A symbol of “” is shown on the top of MP3 files.
- A symbol of “” is shown on the top of JPEG files.
- A symbol of “” is shown on the top of WMA files.
- If the track extends beyond the scope of screen, a down arrow “▼” appears, indicating that the user can view another part on the next page. If an up arrow “▲” appears, it indicates that the user can view another part on the previous page. The current page number and the number of total pages are shown on the right of the down arrow “▼”.
- The system can recognize up to 255 groups (or folders) and up to 256 tracks. (This applies to the case where mixed MP3, JPEG and WMA files are recorded.)
- If no MP3, JPEG or WMA files are found in the group, the group is not displayed.
- The DVD player can reproduce data recorded as per ISO 9660 Level 1, Level 2 or Joliet on the disc.
- It can also run a disc on which data is recorded in a multi-session.
- For more details of recording systems, see the instruction manual for the CD-R / CD-RW drive or the writing software.
- For MP3 and WMA files recorded in Variable Bit Rate (VBR), the unit may not display the actual elapsed time.

For discs of JPEG or Kodak Picture CD:

- A JPEG or Kodak Picture CD menu appears.
- If all menu items cannot be displayed in the screen scope, “▶▶” appears at the right bottom of the screen, indicating that the user can view remaining items on the next page. If “◀◀” appears, it indicates that the user can view other items on the previous page. The track number of the currently highlighted item and the total tracks are shown at the center bottom of the screen.
- If “▶▶” is shown at the right bottom, use the **SKIP ▶▶** button to view the next page. If “◀◀” is shown at the left bottom, use the **SKIP ◀◀** button to view the previous page.
- It may take some time until all menu items are displayed on the menu screen.

2 For MP3, JPEG or WMA, press the **Cursor** buttons (▲ or ▼), or for Kodak Picture CD, press the **Cursor** buttons (◀/▶/▲/▼) to select a desired group or track.

- To return to the previous screen, press the **Cursor** button (◀).
- If a group (folder) is selected, press the **Cursor** button (▶) or **ENTER** button to go on to the track selection screen. Press the **Cursor** buttons (▲ or ▼) to choose a track, then press the **PLAY** or **ENTER** button.
- If a track is selected, press the **PLAY** or **ENTER** button to start playing back tracks. The selected track and the subsequent tracks will be played back.
- When selecting the folders
 - Press the **Cursor** button (▶) when you want to go to the next hierarchy.
 - Press the **Cursor** button (◀) when you want to go back to the previous hierarchy (except for the top hierarchy).
- If an MP3 or WMA file is selected, reproduction will start from the selected track and go to the next one in turn.
- If a JPEG or Kodak Picture CD file is selected, an image will be reproduced from the selected track and go to the next one in turn.

PLAYING A DISC

3 Press the **STOP** button to stop playback.

Notes on MP3, JPEG and WMA:

- Select "FIRST PLAY" and press the **PLAY** button, playback from the top of the disc in the order of tracks and groups.
- The ninth and deeper hierarchies cannot be played.
- The name of group and track can be displayed in up to 25 characters. Alphabets, numerals underline, asterisk or space may not be displayed. Unrecognizable characters will be replaced with asterisks.
- Un-reproducible groups or tracks may be displayed depending on the recording conditions.
- If the **TOP MENU** button is pressed when a file list is displayed, "FIRST PLAY" will be highlighted.

Notes on WMA:

- The DVD player can reproduce data recorded as ISO 9660 level 2 with 31 characters file name included punctuation marks. The name of file can be displayed up to 25 characters.
- Maximum of 8 subfolders can be recognized.
- This unit cannot play back copyright protected WMA files.

Notes on JPEG and Kodak Picture CD:

- A track is displayed for five seconds and then the next track is displayed.
- Every press on the **Cursor** button (▶) will turn the image clockwise by 90 degrees when an image is displayed. A press on the **Cursor** button (◀) will turn the image counterclockwise by 90 degrees.
- Progressive JPEGs (JPEG files saved in the progressive format) will not be played back on this DVD player.
- High resolution JPEG files take longer to be displayed.

Notes on Kodak Picture CD:

- A press on the **STOP** button will highlight the previously displayed track on the menu screen.
Press the **STOP** button again or press the **TOP MENU** button, and the menu screen displays tracks 1 to 6, where track 1 is highlighted.

Slide Show Mode

JPEG

You can switch to the slide show mode during playback.

1 Press the **MODE** button during playback.

- The slide show mode screen will appear.
- The slide show mode cannot be switched when it is stopped, or from the file list screen or the Picture CD menu screen.

2 Press the **ENTER** button.

- The slide show mode will change.
 - 1 The entire image appears in one time.
 - 2 The image appears gradually and then disappears.

3 Press the **MODE** button to exit.

On-Screen Information

MP3 JPEG WMA

You can check each file during playback.

1 Press the **DISPLAY** button once during playback to show current Disc number.

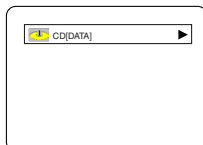

2 Press the **DISPLAY** button again.

- The name of the file currently in play will be displayed.

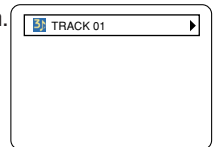

<Example: MP3>

3 Press the **DISPLAY** button for the third time to show the track number, the elapsed time (MP3 and WMA), the repeat status, and the playback status at the top of the screen.

- ◁ will be displayed when the repeat play has been selected.
 - ◁ T - indicates Track repeat
 - ◁ G - indicates Group (folder) repeat
 - ◁ D - indicates Disc repeat
 - ◁ 5 - indicates 5 Disc repeat

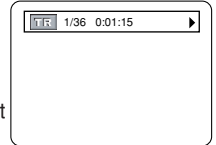

4 Press the **DISPLAY** button for the fourth time to exit.

- During program or random playback, each playback status will be displayed when you press the **DISPLAY** button. Then press the **DISPLAY** button again to exit.

Track Selection

MP3 JPEG WMA

1 Press the **SEARCH MODE** button during playback.

- The FILE LIST will appear.

2 Select a desired track using the **Cursor** buttons

- (▼/▲/▶/◀).
- Press the **Cursor** button (▶) when you want to go to the next hierarchy.
- Press the **Cursor** button (◀) when you want to go back to the previous hierarchy.

3 Press the **PLAY** button to start playing

NOTES:

- Press the **SEARCH MODE** button to exit.
- Some selections may require additional time to be recognized.
- During playback a desired track can be directly searched. Just press the track number with the **Numeric** buttons.
- If the pressed track number is not available, the "disable" symbol appears and the direct search mode is cancelled.
- Playback cannot be started from a desired time count.
- Pressing the **SKIP** button ▶▶ or ◀◀ will play the next or previous file.
- The **SEARCH** button is not effective for Picture CD.

Random Playback

MP3 JPEG WMA

1 Press the **RANDOM** or **MODE** button while playback is stopped.

- The **RANDOM** screen will appear.

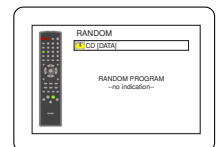

2 Press the **PLAY** button to play the tracks in random order.

- You cannot go back to the previous track during random playback.
- For a disc containing mixed MP3, JPEG and WMA files, random playback of those files will be performed.

PLAYING A DISC

Program Playback

MP3 **JPEG** **WMA**

This function allows you to program a playback order of MP3, JPEG or WMA in a desired sequence.

1 Press the **MODE** button while playback is stopped.

- The PROGRAM screen will appear.

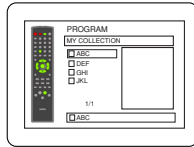

2 Press the **Cursor** buttons (▲ or ▼) to select a group, then press the **ENTER** button.

- A track selection screen appears.

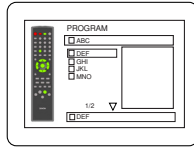

3 Press the **Cursor** buttons (▲ or ▼) to select a track, then press the **ENTER** button to save it in a program.

- Press the **CLEAR** button to erase the incorrect input.
- The programmed track is displayed in the right-hand screen.
- If the entire program cannot be displayed at once on the screen, "▼" appears to go to the next page.
- Pressing the **Cursor** button (◀) will show a list of folders that belong to the one-level upper hierarchy than the currently selected folder.

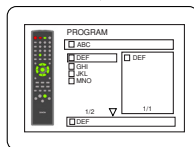

4 Press the **PLAY** button to start programmed playback.

NOTES:

- Press the **RETURN** button, and the stop screen will show up with the program contents in memory.
- Press the **STOP** button once and then the **PLAY** button again, playback will restart from the point where the **STOP** button was pressed. (Program continued)
- Press the **STOP** button twice and then the **PLAY** button again, playback will restart from the track in the usual way. (Program cleared)
- The program setting will be cancelled when the power is turned off or the disc tray is opened.
- Up to 99 tracks can be set in a program.
- If you wish to repeat the current track in the program, press the **REPEAT** button repeatedly until **TRACK** appears during playback. If you wish to repeat the entire program press the **REPEAT** button repeatedly until **DISC** appears during playback.
- If an inserted disc contains mixed MP3, JPEG and WMA files, program setting allows 99 tracks for combination of MP3, JPEG and WMA files.
- If eight or more tracks were set in a program, use the **SKIP** (◀◀ or ▶▶) button to see all the tracks.

Audio Language

DVD

The DVD player allows you to select a language (if multiple languages are available) during DVD disc playback.

1 Press the **AUDIO** button during playback.

2 Press the **AUDIO** button repeatedly to select your desired language.

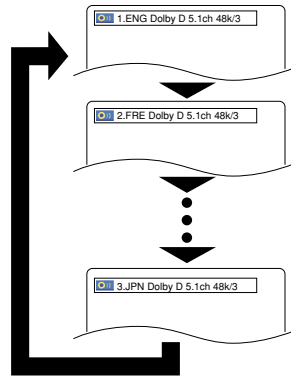

...

NOTES:

- The sound mode cannot be changed during playback of discs not recorded in double sound.
- Some discs allow to change audio language setting on the disc menu. (Operation varies between discs. Refer to the manual accompanying the disc.)
- Pressing the **AUDIO** button may not work on some DVDs with multiple audio languages (e.g. DVDs which allow audio language setting on the disc menu).
- If you choose a language that has a three-letter language code, the code will be displayed every time you change the Audio Language setting. If you choose any other languages, '---' will be displayed instead (refer to page 26).

Stereo Sound Mode

CD

1 Press the **AUDIO** button repeatedly during playback to select between STEREO, L-CH or R-CH.

STEREO - both right and left channels are active (stereo)

L-CH - only left channel is active

R-CH - only right channel is active

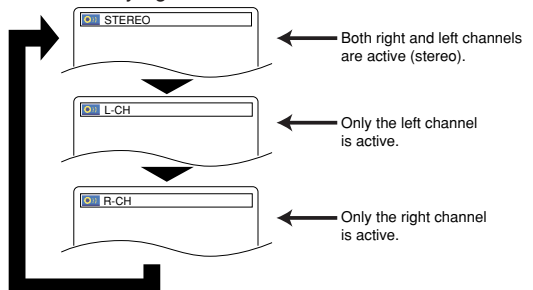

NOTES:

- If the Virtual Surround setting is ON, the sound mode will be fixed to STEREO, and can not be changed.
- Stereo sound mode will not be changed when playing DTS CD.

Subtitle Language

DVD

The DVD player allows you to select a subtitle language (if multiple languages are available) during DVD playback.

- 1 Press the **SUBTITLE** button during playback.
- 2 Press the **SUBTITLE** button repeatedly to select your desired subtitle language.
 - The selected language will be displayed on the display bar at the top of the screen.
- 3 To turn off subtitles, press the **SUBTITLE** button repeatedly until OFF appears.

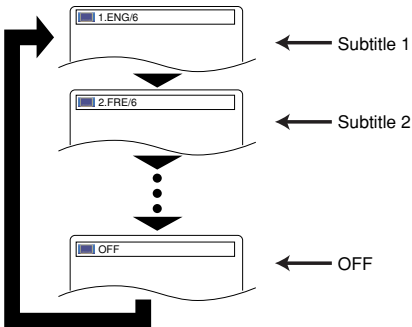

NOTES:

- Some discs allow subtitle language setting on the disc menu. (Operation varies between discs, so refer to the manual accompanying the disc.)
- Pressing the **SUBTITLE** button may not work on some DVDs with multiple subtitle languages (e.g. DVDs which allow subtitle language setting on the disc menu).
- If the desired language is not shown after pressing the **SUBTITLE** button several times, the disc does not have subtitles in that language.
- If you choose a language that has a three-letter language code, the code will be displayed every time you change the Subtitle Language setting. If you choose any other languages, "----" will be displayed instead. (Refer to page 26.)

Camera Angle

DVD

Some DVD discs contain scenes which have been shot simultaneously from various angles. You can change the camera angle when the (ANGLE) mark appears on the screen.

- 1 Press the **ANGLE** button during playback.
 - The selected angle will be displayed on the display bar at the top of the screen.
- 2 Press the **ANGLE** button repeatedly to select your desired angle.

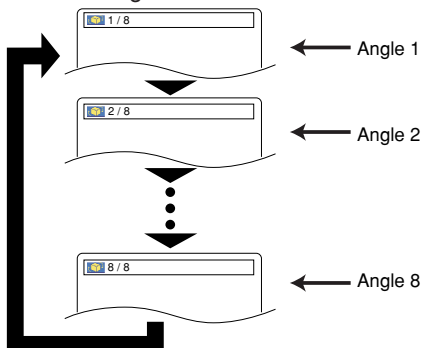

NOTE:

- If the "ANGLE ICON" setting is "OFF" in the Display menu, the (ANGLE) will not appear.

Changing the On-Screen Display

DVD

You can check information about the current disc by pressing the **DISPLAY** button on the remote control.

- 1 Press the **DISPLAY** button once during playback to show current disc number.
- 2 Press the **DISPLAY** button again during playback.
 - Current chapter number/total chapters, elapsed time and remaining time of the current chapter, and current playback status will be displayed.
- 3 Press the **DISPLAY** button again.
 - Current title number/total titles, elapsed time and remaining time of the current title, and current playback status will be displayed.

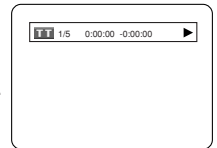
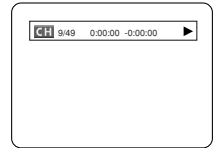
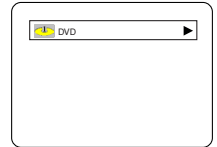

- 4 Press the **DISPLAY** button again.

- The bit rate (the amount of video data currently being read) and current playback status will be displayed.
- Current repeat setting appears on the display bar only when the repeat setting is active. (◁C: Chapter repeat/◁T: Title repeat/A◁B: A-B repeat)
- If you are playing a dual layered disc, the layer number will also be displayed (L0: Layer 0 is played. L1: Layer 1 is played).



- 5 Press the **DISPLAY** button again to remove the display.

CD

- 1 Press the **DISPLAY** button once during playback to show current disc number.
- 2 Press the **DISPLAY** button again.
 - Current track number/total tracks, elapsed time and remaining time of the current track, and current playback status will be displayed.
 - Current repeat setting appears on the display bar only when the Repeat setting is active. (◁T: Track repeat/◁D: Disc repeat/◁5: 5Disc repeat/A◁B: A-B repeat)
- 3 Press the **DISPLAY** button again.
 - Current track number/total tracks, elapsed time and remaining time of the entire disc, and current playback status will be displayed.
 - Current repeat setting appears on the display bar only when the Repeat setting is active. (◁T: Track repeat/◁A: All tracks repeat/A◁B: A-B repeat)
- 4 Press the **DISPLAY** button again to remove the display.
 - During program or random playback, each playback status will be displayed when you press the **DISPLAY** button. Then press the **DISPLAY** button again to exit.

Marker Setup Screen

DVD

Use markers to memorize your favourite places on a disc.

- 1 Press the **SEARCH MODE** button four times during playback.
 - The display screen and Markers will appear on the TV screen.

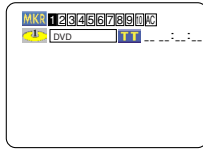

- 2 Press the **Cursor** buttons (◀ or ▶) to select 1, 2, 3, 4, 5, 6, 7, 8, 9, or 10 and ensure that “_ : _ : _” appears in the display.
- 3 When reaches the desired point, press the **ENTER** button.
 - The title or track and elapsed playing time will appear in the TV screen.
- 4 To return to the Marker later, press the **SEARCH MODE** button four times during playback and the **Cursor** buttons (◀ or ▶) to choose the desired marker, then press the **ENTER** button.

NOTES:

- Opening the disc tray, turning off the power or selecting AC at step 2 and pressing the **ENTER** button will erase all Markers.
 - To clear a marker, using the **Cursor** buttons (◀ or ▶), position the cursor on to the marker number to be cleared and press the **CLEAR** button.
 - You can mark up to 10 points.
- 5 Press the **SEARCH MODE** or **RETURN** button to exit.

CD

- 1 Press the **SEARCH MODE** button three times during playback.
 - The display screen and Markers will appear on the TV screen.
- 2 Press the **Cursor** buttons (◀ or ▶) to select 1, 2, 3, 4, 5, 6, 7, 8, 9, or 10 and ensure that “_ : _ : _” appears in the display.
- 3 When reaches the desired point, press the **ENTER** button.
 - The title or track and elapsed playing time will appear in the TV screen.
- 4 To return to the Marker later, press the **SEARCH MODE** button three times during playback and the **Cursor** buttons (◀ or ▶) to choose the desired marker, then press the **ENTER** button.

NOTES:

- Opening the disc tray, turning off the power or selecting AC at step 2 and pressing the **ENTER** button will erase all Markers.
 - To clear a marker, using **Cursor** buttons (◀ or ▶), position the cursor on to the marker number to be cleared and press the **CLEAR** button.
 - You can mark up to 10 points.
- 5 Press the **SEARCH MODE** or **RETURN** button to exit.

Black Level Setting

DVD

Adjust the Black Level Settings to make the black parts of the picture as bright as you prefer.

- 1 Press the **MODE** button during playback.
- 2 Press the **ENTER** button to switch ON/OFF.
 - ON (Default) : Makes the dark parts brighter.
 - OFF : Shows the original picture as recorded.

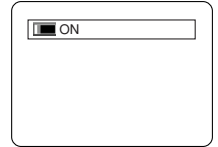

- 3 Press the **MODE** or **RETURN** button to exit.

Virtual Surround

DVD

You can enjoy stereophonic visual space on your existing 2 channel stereo system.

- 1 Press the **MODE** button twice during playback.
 - OFF
- 2 Press the **ENTER** button to set it 1(Natural effect), 2(Emphasized effect) or OFF.
- 3 Press the **RETURN** button to exit.

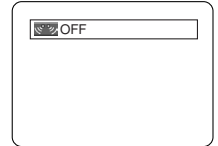

CD

MP3

WMA

- 1 Press the **MODE** button during playback.
- 2 Press the **ENTER** button to set 1(Natural effect), 2(Emphasized effect) or OFF.
- 3 Press the **RETURN** button to exit.

NOTES:

- Select Virtual Surround OFF or adjust the volume down if the sound is distorted.
- Virtual Surround will not be effective if the sound mode is set to something other than “STEREO” (for Audio CD playback only).

In Setup menu, QUICK mode and CUSTOM mode are available. QUICK mode consists of the setting menus often needed, and you can make all settings in CUSTOM mode. You can make the settings of the items with **QUICK** mark in QUICK mode.

Language Setting

Language options are not available with some discs.

- 1 Press the **SETUP** button in stop mode.
- 2 Press the **Cursor** button (▶) to select CUSTOM, then press the **ENTER** button.
 - CUSTOM mode will appear.
- 3 Press the **Cursor** buttons (◀ or ▶) to select LANGUAGE, then the **ENTER** button to confirm.

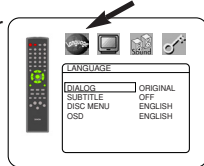

- 4 Press the **Cursor** buttons (▲ or ▼) to select the below items, then press the **ENTER** button.

DIALOG (Default : ORIGINAL)
 • Sets the audio language.



SUBTITLE (Default : OFF)
 • Sets the subtitle language.



DISC MENU (Default : ENGLISH)
 • Sets the language for DVD Menu.



OSD (Default : ENGLISH) QUICK
 • Sets the language for the On-Screen display.



- 5 Press the **Cursor** buttons (▲ or ▼) to select a setting, then press the **ENTER** button.
 - If OTHERS is selected in the DIALOG, SUBTITLE or DISC MENU screen, press four-digit number to enter the code for the desired language. (Refer to the language code list on page 26).
 - Only the languages supported by the disc can be selected.
- 6 Press the **SETUP** button to exit.

NOTE:

- Language Setting for DIALOG and SUBTITLE is not available with some discs. Then use the **AUDIO** and **SUBTITLE** buttons. Details are on pages 21 and 22.

Display Setting

You can change certain aspects of the DVD display screens, on-screen messages and the display panel on the front of the DVD player.

- 1 Press the **SETUP** button in stop mode.
- 2 Press the **Cursor** button (▶) to select CUSTOM, then press the **ENTER** button.
 - CUSTOM mode will appear.
- 3 Press the **Cursor** buttons (◀ or ▶) to select DISPLAY, then the **ENTER** button to confirm.

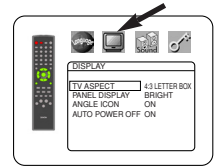

- 4 Press the **Cursor** buttons (▲ or ▼) to select an item, then press the **ENTER** button.

TV ASPECT (Default : 4:3 LETTER BOX) QUICK

- Press the **Cursor** buttons (▲ or ▼) for an item selection, then press the **ENTER** button.
- Select 4:3 LETTER BOX for a black bars appears on top and bottom of the screen.
- Select 4:3 PAN & SCAN for a full height picture with both sides trimmed.
- Select 16:9 WIDE if a wide-screen TV is connected to the DVD player.



PANEL DISPLAY (Default : BRIGHT)

- Press the **Cursor** buttons (▲ or ▼) for an item selection (BRIGHT, DIMMER or AUTO) then press the **ENTER** button.
- When AUTO is selected, the display dims only during playback.



ANGLE ICON (Default : ON)

- Press the **ENTER** button repeatedly to turn Angle mark ON or OFF.



AUTO POWER OFF (Default : ON)

- Press the **ENTER** button repeatedly to turn AUTO POWER OFF ON or OFF.
- It will turn the DVD player to off automatically after 35 minutes of no use.



- 5 Press the **SETUP** button to exit.

NOTES:

- Be sure to press the **SETUP** button, or the setting will not work.
- You can also choose the item by pressing the numbers.

Audio Setting

Choose the appropriate Audio settings for your equipment as it only affect during the playback of DVD discs of the DVD player.

- 1 Press the **SETUP** button in stop mode.
- 2 Press the **Cursor** button (▶) to select CUSTOM, then press the **ENTER** button.
 - CUSTOM mode will appear.
- 3 Press the **Cursor** buttons (◀ or ▶) to select AUDIO, then the **ENTER** button to confirm.

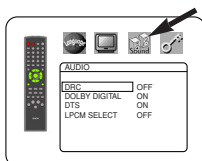

- 4 Press the **Cursor** buttons (▲ or ▼) to select an item, then press the **ENTER** button.

DRC (Dynamic Range Control) (Default : OFF)

- To compress the range of sound volume.
- DRC function is available only on the discs that are recorded in the Dolby Digital format.

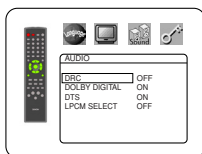

DOLBY DIGITAL (Default : ON)

QUICK

- Set to ON when the player is connected to Dolby Digital Decoder.
- ON : Output by Dolby Digital
- OFF : Convert the Dolby Digital to PCM
- This function is effective only for the COAXIAL and OPTICAL connections.

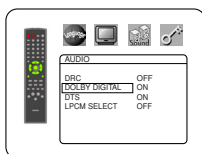

DTS (Default : ON)

- Set to ON when the unit is connected to DTS Decoder.
- ON : Output by DTS sound
- OFF: No DTS sound will be output.
- This function is effective only for the COAXIAL and OPTICAL connections.

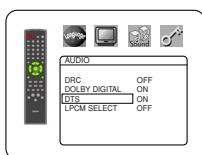

LPCM SELECT (Default : OFF)

- Set to ON when outputting in 48kHz.

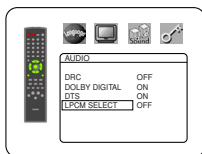

When playing disc with copyright protection

- Even if you select OFF, copyright protection will be activated and sound will be down sampled at 48kHz.

- 5 Press the **SETUP** button to exit.

Ratings Control

Ratings Control limits playback of discs with unsuitable audience ratings. A four digit code established by the user will unlock the parental lock.

This feature allows you to prevent your children from playing discs with objectionable scenes.

RATING LEVEL

Rating Level allows you to set the rating level of your DVD discs. Playback will stop if the disc's ratings exceed the level you set.

- 1 Press the **SETUP** button in stop mode.
- 2 Press the **Cursor** button (▶) to select CUSTOM, then press the **ENTER** button.
- 3 Press the **Cursor** buttons (◀ or ▶) to select RATINGS, then press the **ENTER** button.
- 4 Press the **Numeric** buttons to enter your four-digit password.
 - When doing this for the first time, enter any four-digit number by pressing the **Numeric** buttons (except for 4737), then press the **ENTER** button. That number will be used as the password from the second time onward. Record your password in case you forget it.
- 5 Press the **Cursor** buttons (▲ or ▼) to select RATING LEVEL, then press the **ENTER** button.

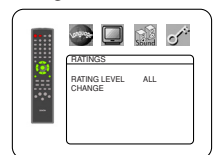

- 6 Press the **Cursor** buttons (▲ or ▼) button to select the desired level, then press the **ENTER** button.

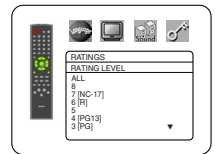

- 7 Press the **SETUP** button to exit.

NOTE:

- This function may not work on some DVDs. Be sure if the RATINGS operates in the way you have set.

To Change the Password:

- 1) Follow the steps **1** to **4** above.
- 2) Press the **Cursor** buttons (▲ or ▼) to select CHANGE, then press the **ENTER** button.
- 3) Enter a new four-digit password, then press the **ENTER** button.
- 4) Press the **SETUP** button to exit.

IF YOU FORGET THE PASSWORD

- 1 Press **4, 7, 3, 7** at step **4**.
 - Password will be cleared and rating level will be set to ALL.
- 2 Repeat steps **4** to **7** to re-establish the parental lock.

CONTROL LEVELS

- **ALL**
Parental lock is cancelled.
- **Level 8**
DVD software of any grade (adult/general/children) can be played back.
- **Levels 7 to 2**
Only DVD software intended for general use and children can be played back.
- **Level 1**
Only DVD software intended for children can be played back, with those intended for adult and general use prohibited.

DVD SETUP

<u>Language</u>	<u>Code</u>	<u>Language</u>	<u>Code</u>	<u>Language</u>	<u>Code</u>	<u>Language</u>	<u>Code</u>
	A-B						
Abkhazian	4748	Frisian	5271	Malay	5965	Somali	6561
Afar	4747	Galician	5358	Malayalam	5958	Spanish [SPA]	5165
Afrikaans	4752	Georgian	5747	Maltese	5966	Sundanese	6567
Albanian	6563	German [GER]	5051	Maori	5955	Swahili	6569
Amharic	4759	Greek [GRE]	5158	Marathi	5964	Swedish [SWE]	6568
Arabic	4764	Greenlandic	5758	Moldavian	5961	T	
Armenian	5471	Guarani	5360	Mongolian	5960	Tagalog	6658
Assamese	4765	Gujarati	5367	Nauru	6047	Tajik	6653
Aymara	4771	Hausa	5447	Nepali	6051	Tamil	6647
Azerbaijani	4772	Hebrew	5569	Norwegian [NOR]	6061	Tatar	6666
Bashkir	4847	Hindi	5455	O-R		Telugu	6651
Basque	5167	Hungarian [HUN]	5467	Occitan	6149	Thai	6654
Bengali;Bangla	4860	I-K		Oriya	6164	Tibetan	4861
Bhutani	5072	Icelandic [ICE]	5565	Oromo(Afan)	6159	Tigrinya	6655
Bihari	4854	Indonesian	5560	Panjabi	6247	Tonga	6661
Bislama	4855	Interlingua	5547	Pashto;Pushto	6265	Tsonga	6665
Breton	4864	Interlingue	5551	Persian	5247	Turkish [TUR]	6664
Bulgarian	4853	Inupiak	5557	Polish	6258	Turkmen	6657
Burmese	5971	Irish [IRI]	5347	Portuguese [POR]	6266	Twi	6669
Byelorussian	4851	Italian [ITA]	5566	Quechua	6367	U-Z	
C-E		Japanese [JPN]	5647	Rhaeto-Romance	6459	Ukrainian	6757
Cambodian	5759	Javanese	5669	Romanian [RUM]	6461	Urdu	6764
Catalan	4947	Kannada	5760	Russian [RUS]	6467	Uzbek	6772
Chinese [CHI]	7254	Kashmiri	5765	S		Vietnamese	6855
Corsican	4961	Kazakh	5757	Samoaan	6559	Volapuk	6861
Croatian	5464	Kinyarwanda	6469	Sangho	6553	Welsh	4971
Czech	4965	Kirghiz	5771	Sanskrit	6547	Wolof	6961
Danish [DAN]	5047	Kirundi	6460	Scots Gaelic	5350	Xhosa	7054
Dutch [DUT]	6058	Korean [KOR]	5761	Serbian	6564	Yiddish	5655
English [ENG]	5160	Kurdish	5767	Serbo-Croatian	6554	Yoruba	7161
Esperanto	5161	L-N		Sesotho	6566	Zulu	7267
Estonian	5166	Laothian	5861	Setswana	6660		
F-H		Latin	5847	Shona	6560		
Faroese	5261	Latvian;Lettish	5868	Sindhi	6550		
Fiji	5256	Lingala	5860	Singhalese	6555		
Finnish [FIN]	5255	Lithuanian	5866	Siswat	6565		
French [FRE]	5264	Macedonian	5957	Slovak	6557		
		Malagasy	5953	Slovenian	6558		

If you choose a Language that has a 3 letter language code, the code will be displayed every time you change the Audio or Subtitle language setting on pages 21 and 22. If you choose any other languages, '---' will be displayed instead. (3 letter language code is written in bracket.)

Cleaning the Cabinet

- Use a soft cloth slightly moistened with a mild detergent solution. Do not use a solution containing alcohol, spirits, ammonia or abrasives.

Cleaning Discs

- When a disc becomes dirty, clean it with a cleaning cloth. Wipe the disc from the center out. Do not wipe in a circular motion.
- Do not use solvents such as benzine, thinner, commercially available cleaners, detergent, abrasive cleaning agents or antistatic spray intended for analog records.

Cleaning the disc lens

- If the player still does not perform properly while referring to the relevant sections and to “TROUBLESHOOTING GUIDE” in this Operating Instruction, the laser optical pickup unit may be dirty. Consult your dealer or an Authorized Service Center for inspection and cleaning of the laser optical pickup unit.

Disc Handling

- Use discs which have the following logos on them.
- Handle the discs so that fingerprints and dust do not adhere to the surfaces of the discs.
- Always store the disc in its protective case when it is not used.
- Note that discs with special shapes (heart-shaped discs, octagonal discs, etc.) cannot be played on this product. Do not attempt to play such discs, as they may damage the player.



MP3



TROUBLESHOOTING GUIDE

If the DVD player does not perform properly when operated as instructed in this Operating Instruction, check the player, consulting the following checklist.

Problem	Solution
No power	<ul style="list-style-type: none"> –Check if the AC power cord is properly connected. –Unplug the AC power cord once, and wait for 5-10seconds and then plug it in again.
No sound or picture	<ul style="list-style-type: none"> –Check if the TV is switched on. –Check the video connection. –Check the VIDEO/AUDIO cable connections to the TV. –DTS sound cannot be produced with an analog connection.
Distorted picture	<ul style="list-style-type: none"> –Sometimes a small amount of picture distortion may appear. This is not a malfunction. –Connect the DVD player directly to the TV.
Completely distorted picture or black/white picture with DVD	<ul style="list-style-type: none"> –Connect the DVD player directly to the TV. –Make sure the disc is compatible with the DVD player.
No sound or distorted sound	<ul style="list-style-type: none"> –Adjust the volume. –Check that the speakers are connected correctly.
No audio at digital output	<ul style="list-style-type: none"> –Check the digital connections. –Check the audio settings.
No DTS sound output	<ul style="list-style-type: none"> –Use a DIGITAL OUT jack when outputting the DTS sound.
Picture freezes momentarily during playback	<ul style="list-style-type: none"> –Check the disc for fingerprints/scratches and clean with a soft cloth wiping from center to edge. –Clean the disc.
Disc can't be played	<ul style="list-style-type: none"> –Clean the disc. –Ensure the disc label is facing up. –Check if the disc is defective by trying another disc. –Cancel the parental lock or change the control level. –Insert a correct disc that plays on this player.
No return to start-up screen when disc is removed	<ul style="list-style-type: none"> –Reset the player by switching the player off, then on again.
The player does not respond to the remote control	<ul style="list-style-type: none"> –Aim the remote control directly at the sensor on the front of the player. –Reduce the distance to the player. –Replace the batteries in the remote control. –Re-insert the batteries with their polarities (+/- signs) as indicated.
Buttons do not work or player stops responding	<ul style="list-style-type: none"> –To completely reset the player, unplug the AC cord from the AC outlet for 5-10 seconds.
Player does not respond to some operating commands during playback	<ul style="list-style-type: none"> –Operations may not be permitted by the disc. Refer to the instructions of the disc.
DVD player cannot read CDs/DVDs	<ul style="list-style-type: none"> –Use a commonly available CD/DVD cleaner to clean the lens before sending the DVD player for repair.
Angle does not switch	<ul style="list-style-type: none"> –The angle cannot be switched for DVDs which do not contain multiple angles. In some cases multiple angles are only recorded for specific scenes.
Playback does not start when the title is selected	<ul style="list-style-type: none"> –Check the "RATINGS" setting.
The password for rating level has been forgotten	<ul style="list-style-type: none"> –Enter the default password "4737", then your forgotten password will be cleared.

NOTES:

- Some functions are not available in specific modes, but this is not a malfunction. Read the description in this Operating Instruction for details on correct operations.
- Playback from a desired track and random playback are not available during program playback.
- Some functions are prohibited on some discs.

SPECIFICATIONS

SIGNAL SYSTEM

NTSC color

APPLICABLE DISCS

- (1) DVD-Video discs
 - 1-layer 12cm single-sided discs, 2-layer 12cm single-sided discs, 2-layer 12cm double-sided discs (1 layer per side)
 - 1-layer 8cm single-sided discs, 2-layer 8cm single-sided discs, 2-layer 8cm double-sided discs (1 layer per side)
- (2) DVD-R/DVD-RW
- (3) Compact discs (Audio CD)
 - 12cm discs, 8cm discs
- (4) CD-R/CD-RW

S-VIDEO OUTPUT

Y output level: 1Vp-p (75Ω/ohms)
 C output level: 0.286Vp-p
 Output connectors: S connectors, 1 set

VIDEO OUTPUT

Output level: 1Vp-p (75Ω/ohms)
 Output connector: Pin jacks, 1 set

COMPONENT OUTPUT

Y output level: 1Vp-p (75Ω/ohms)
 Pb/Cb output level: 0.7Vp-p (75Ω/ohms)
 Pr/Cr output level: 0.7Vp-p (75Ω/ohms)
 Output connector: Pin jacks, 1 set

AUDIO OUTPUT

Output level: 2Vrms
 2 channel (L, R) output connector: Pin jack, 1 set

AUDIO OUTPUT PROPERTIES

- (1) Frequency response
 - 1 DVDs (linear PCM) : 4Hz to 22kHz (48kHz sampling)
 - : 4Hz to 44kHz (96kHz sampling)
 - 2 CDs : 4Hz to 20kHz
- (2) S/N ratio : 115dB
- (3) Total harmonic distortion : 1kHz CD: 0.003%
- (4) Dynamic range : DVD: 100dB
 CD: 98dB

DIGITAL AUDIO OUTPUT

Optical digital output: Optical connector, 1 set
 Coaxial digital output: Pin jack, 1 set

POWER SUPPLY

AC 120V, 60Hz

POWER CONSUMPTION

17W (Standby: 0.6W)

MAXIMUM EXTERNAL DIMENSIONS

W: 17-1/8" (435mm)
 H: 4-3/32" (104mm)
 D: 14-9/16" (370mm)
 (including protruding parts)

MASS

9.48lbs (4.6kg)

REMOTE CONTROL UNIT

RC-1040
 Infrared pulse type
 Supply: DC 3V, 2 R6P/AA batteries

Printed in China
00D 511 4533 002

DENON
TOKYO, JAPAN
www.denon.com

Denon Brand Company, D&M Holdings Inc.
1VMN22544
E8625UD *****