

User Guide



8.5" Portable DVD Player

ELE E850PD

Table of Contents

Table of Contents.....	1
Safety Information.....	2
Remote Control.....	3
Description.....	4
Using the Remote Control.....	5
Connecting Earphones (Optional Accessory).....	6
Connecting to an External Component	7
Connecting to a TV.....	8
Connecting to a Stereo Component.....	9
Using USB Port.....	10
Using the AC Adaptor.....	11
Using the Battery Pack.....	12
Cautions in Using Battery Pack.....	13
Playing a Disc.....	14-16
Playing MP3 and Regular Audio CD.....	17
Playing Picture CD.....	18
Displaying and Sorting Files.....	19
Setting Language for OSD, Menu, Audio, Subtitle.....	20
Setting Screen for Display Format, Screen Saver, TV System.....	21
Setting Audio for Downmix	22
Setting Parental Control, Password, Camera Angle, Default.....	23
Adjusting LCD Screen.....	24
Troubleshooting.....	25-26
Specifications.....	27

Safety Information

Please read all of the safety and operating instructions before operating this Player, follow all warnings placed on the Player and in the user's manual. These safety and operating instructions should be retained for future reference.

Safety Information

- Do not expose the system to excessive moisture, rain, sand, or heat sources.
- Place the DVD Player on a firm, flat surface.
- Keep the DVD Player away from domestic heating equipment and direct sunlight.
- When placing the DVD Player in a cabinet, allow about one inch of space all around the DVD Player for ventilation.

☐ SAFETY WARNING

CLASS 1 LASER PRODUCT / KLASSE 1 LASERPRODUKT / LUOKAN 1 LASERLAITE / KLASSE 1 LASERAPPARAT / PRODUCTO LASER CLASE.

INVISIBLE LASER RADIATION WHEN OPEN AND INTERLOCKS DEFEATED. AVOID EXPOSURE TO BEAM.

⚠ WARNING

1. To prevent fire or electrical shock, do not expose this Player to rain or moisture.
2. To avoid electrical shock, do not open the cabinet, no user-serviceable parts inside, refer servicing to qualified personnel only.
3. Certain countries may regulate the disposal of the battery used to power this product. Please consult with your local authority.
4. Listening with earphones for many hours at maximum volume may damage your hearing.
5. The Player should be connected to a power supply only of the type described in the operating instructions or as marked on the Player.

Attention:

Remove the protection card inside the disc compartment before using this Player.



Remote Control

Remote Control

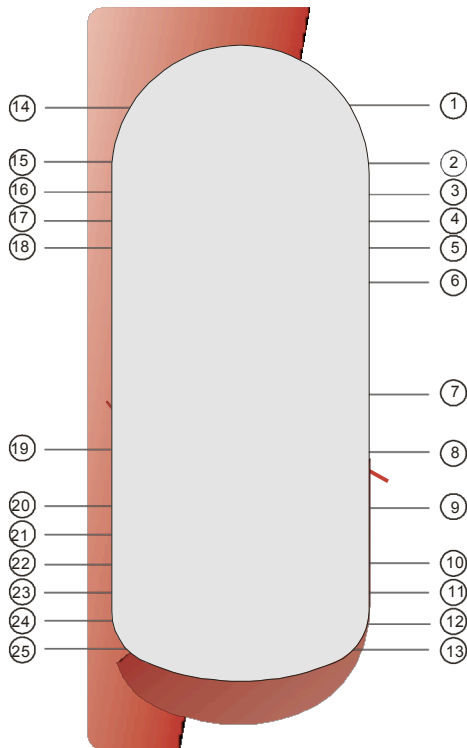

1.MENU/PBC Button

- Brings up the disc menu.

2.L/R Button

- Selects left, right and stereo sound tracks.

3.P/N Button

- Selects PAL/NTSC/AUTO TV systems.

4.TITLE Button

5.SUBTITLE Button

- Selects the subtitle's language.

6.Number Buttons (0,1,...,9)

7.SETUP Button

- Brings up the setup MENU to set up the system's language, audio, display, password etc.

8.(PLAY/ENTER)/DIRECTION Buttons

9.STOP (■) Button

10.SKIP FORWARD (⏭)Button

- Use to skip to next title, chapter or track.

11.SKIP BACKWARD (⏮) Button

- Use to skip to previous title, chapter or track.

12.ZOOM Button

13.GOTO Button

- Use to enter the specific chapter, track or time to playback.

14.DVD/USB Button

- Switches between DVD and USB mode.

15.DISPLAY Button

- Displays the current disc playback information.

16.MUTE Button

17.ANGLE Button

- Use to access various camera angles on a DVD.

18.LANGUAGE Button

- Selects the voice language in a DVD.

19.SLOW Button

20.VOL- Button

- Use to decrease the volume.

21.VOL+ Button

- Use to increase the volume.

22.FAST REVERSE (⏮) Button

23.FAST FORWARD (⏭) Button

24.REPEAT Button

- Allows you to repeat play a title, chapter, track, or disc.

25.MARK Button

- Use to mark a point where the playback starts each time when the MARK button is pressed later on.

Description

■ Front View

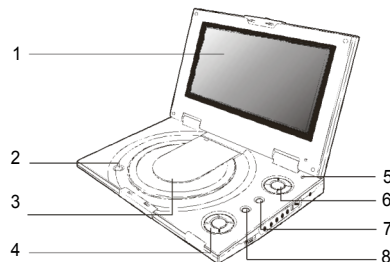

- | | |
|---------------------|---|
| 1. LCD | 5. LCD on/off switch |
| 2. OPEN | 6. CURSOR (UP/DOWN/LEFT/ RIGHT),
ENTER (↵) |
| 3. DISC COVER | 7. MENU/PBC/LCD adj. |
| 4. PLAYBACK BUTTONS | 8. DVD/USB Button |
- PLAY (▶) II ⏪ ⏩
 SKIP-PREVIOUS/FAST II ⏪ ⏩
 REVERSE (◀) / II ⏪ ⏩
 FORWARD/FAST FORWARD (▶) / II ⏪ ⏩
 PAUSE (⏸) / II ⏪ ⏩
 STOP (■)

■ Left View

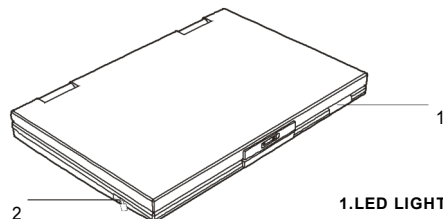

1. LED LIGHT/REMOTE CONTROL SENSOR
2. USB Slot

■ Right View

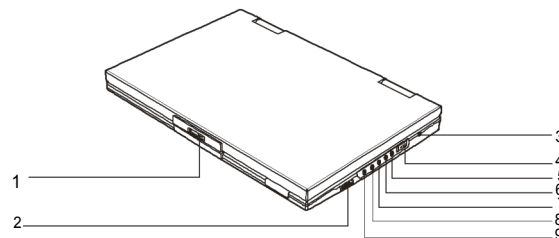

- | | |
|------------------------------|---|
| 1. OPEN | 6. AUDIO IN/OUT |
| 2. EARPHONE / SPEAKER VOLUME | 7. VIDEO OUT |
| 3. DC IN 12V | 8. SPDIF: Digital audio signal
output jack |
| 4. POWER ON/OFF | 9. EARPHONE JACK |
| 5. VIDEO IN | |

■ Bottom View

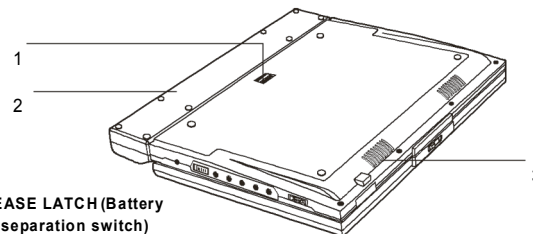

1. RELEASE LATCH (Battery pack separation switch)
2. BATTERY PACK
3. SPEAKER

Using the Remote Control

Installing the battery

1. Open the battery compartment cover using a coin.

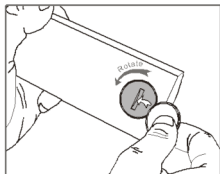

2. Insert a 3V lithium battery into the battery compartment with the polarity (+) facing up as marked.

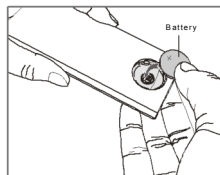

3. Replace the battery compartment cover and turn clockwise until it stops.

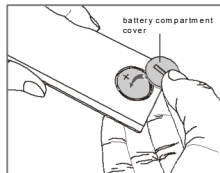

Using the remote control

Point the remote control directly at the remote sensor on the front of the DVD Player.

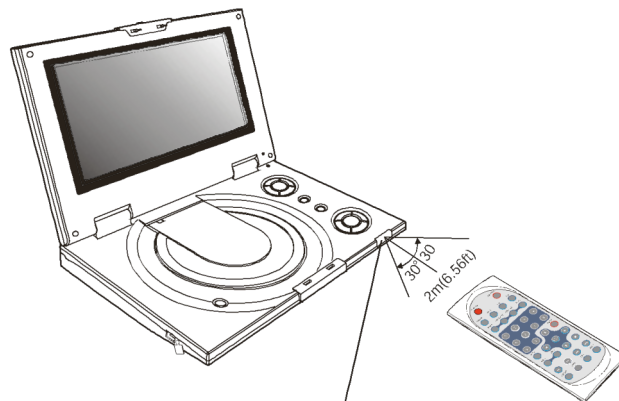

Remote Control Sensor

Connecting Earphones (Optional Accessory)

You can attach an earphone with a stereo mini-jack plug to the phone jack () for private listening. The volume can be adjusted using VOL + and VOL - on the remote control.

Note: When the earphone is connected to the Phone Jack (), the speaker will be disconnected.

*Earphone is an optional accessory



Connecting to an External Component

You can enjoy video from VCR or camcorder on your DVD player.

1. Turn off DVD player, VCR and other components.
2. Connect the audio and videocables as illustrated below.
3. Turn on power.

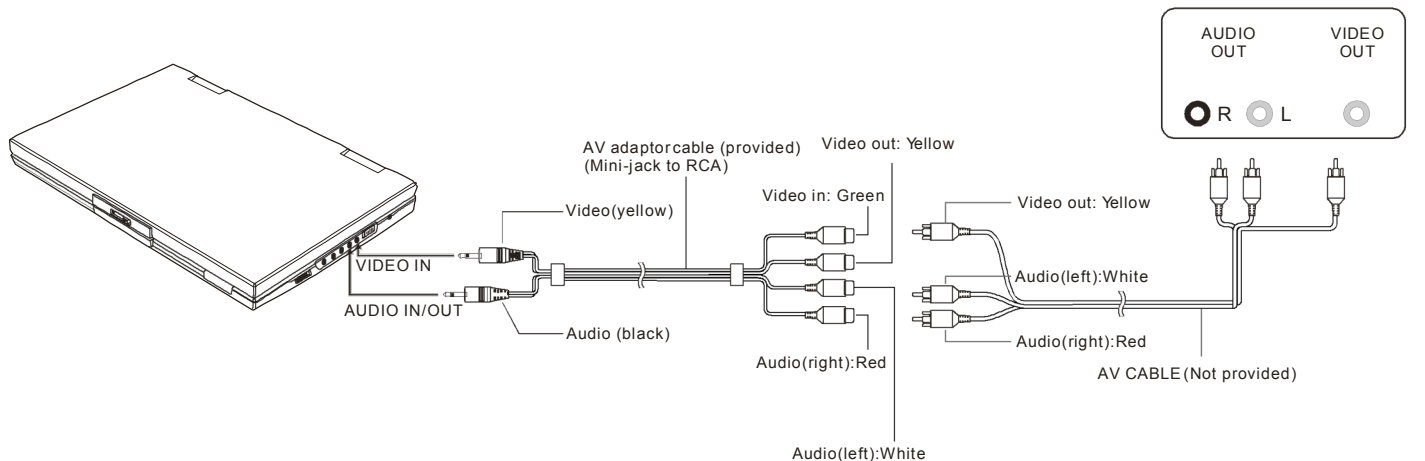

Connecting to a TV

You can enjoy DVD quality video on TV screen.

1. Turn off DVD player and other components.
2. Connect the audio and videocables as illustrated below.
3. Turn on power.
4. Repeatedly press TV/Video button on your TV to select the input from the DVD player.

Connect to a TV equipped with external connection jacks

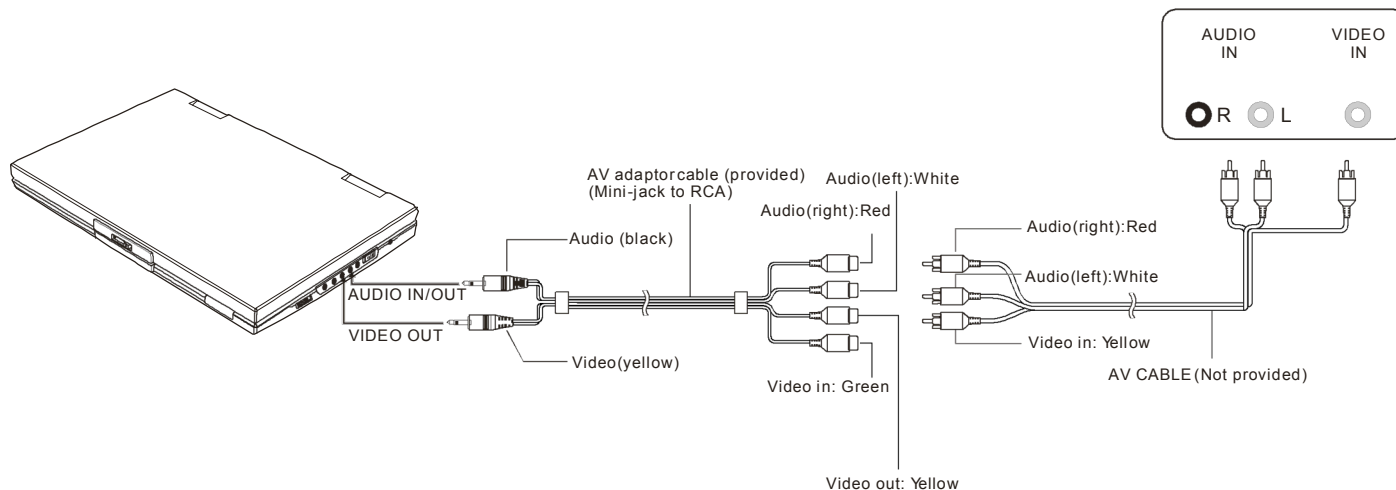

TIPS

- If you wish to view video on your TV only, close the display panel of your Player.
- With the display panel shut, use the remote to control the Player.

Connecting to a Stereo Component

By connecting the digital output (SPDIF) on the DVD player through a coaxial cable (optional accessory) to a Dolby Digital/DTS amplifier or processor, you can enjoy full 5.1 channel surround sound. Follow these steps for making the connection.

1. Turn off both DVD player and your stereo system.
2. Connect the **SPDIF** to your stereosystem as illustrated below.
3. Turn on power of DVD player.

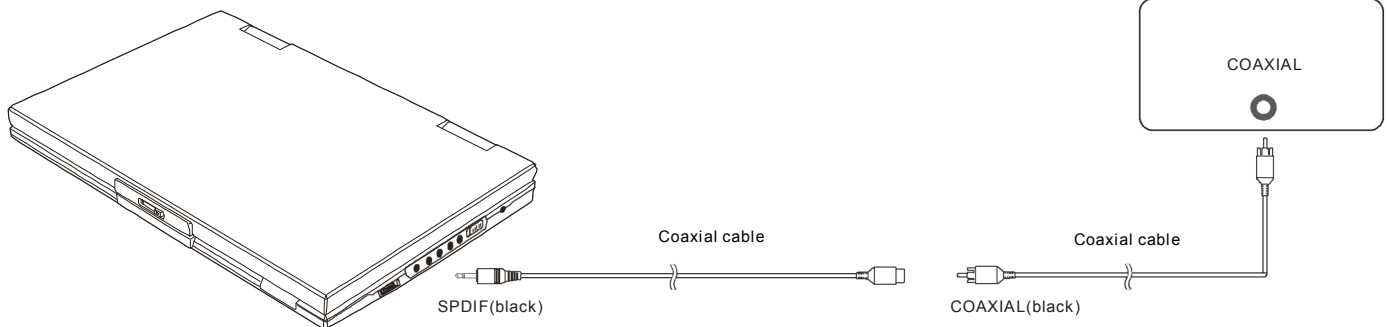

Depending on your amplifier system, you need to make the following selection from **MENU**:

1. Refer to Changing Audio Output on page 22.
2. Select **SPDIF/RAW** if your amplifier has 5.1-channel decoder.
3. Select **SPDIF/PCM** if your amplifier has 2 channels.
4. Select **OFF**, if there is no digital signal output from the DVD player.

Using USB Port

The player accepts most USB devices such as MP3, DSC, USB-drive, Digital Camcorder etc. The USB in this Player supports version 1.1/2.0.

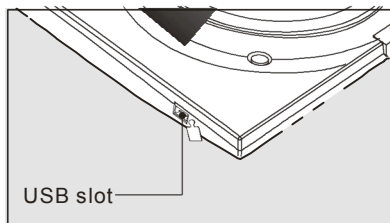

Plugging a USB device

1. Plug in the USB device to the USB port on the player.
2. Repeatedly press **DVD/USB** to select USB mode.

Removing a USB device

You can remove the USB device anytime even it is playing. To remove the USB device, simply grasp the end of the USB and remove it from the slot.

Playing a USB device

1. Insert the USB device and repeatedly press **DVD/USB** to select USB mode. The file manager appears and the first song file of the first folder plays.
2. Use direction key (▲ ▼ and ◀ ▶) to select the file you want to play and press ▶/↵ to play.

Note:

If you have different file types (photo, music, video) in the USB, make sure you have selected to display all file types (see "Displaying and Sorting Files") otherwise, some file types may not display.

Using the AC Adaptor

This portable DVD player can be powered by AC through the supplied switching power AC adaptor. It can also use the supplied battery pack to power.

When the AC adaptor is connected to the unit and powered, the unit will be automatically and electrically disconnected from the battery pack and powered by the AC power.

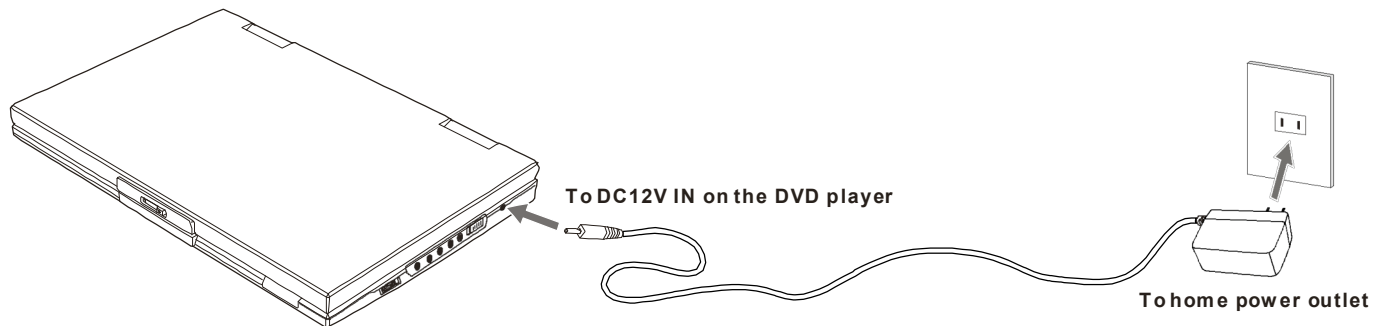

Important !

- Always turn off the DVD Player before connecting or disconnecting the AC cord.
- Only use the AC adaptor supplied with this Player. Using a different type of adaptor may cause malfunction or damage to the product.
- When the AC adaptor is used for prolonged period of time, the adaptor may heat up, this is normal and is not a cause for concern.
- When not using the adaptor, unplug it from the outlet.

Using the Battery Pack

Installing the battery pack

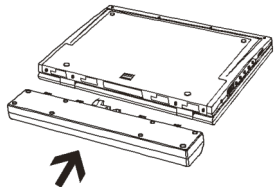

<1>. Align and insert the battery pack into the corresponding slots on the back of the unit.

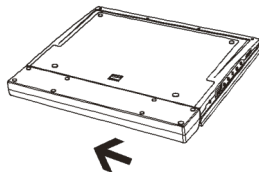

<2>. Slide the battery pack to the left until it clicks into place.

Removing the battery pack

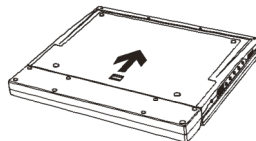

<1>. Slide down the latch.

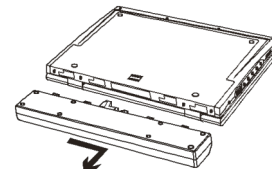

<2>. Slide the battery pack to the right, and remove.

Charging the battery pack

1. Attach the battery pack to the Player.
2. Use the AC adapter to charge the battery pack. Make the connection as illustrated below.
3. Slide **POWER** to **OFF**. (The Player must be turned off to charge the battery).

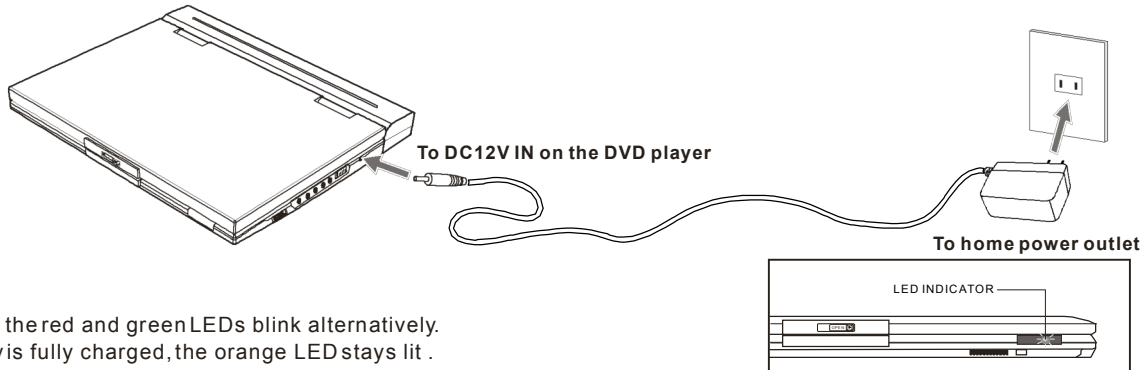

LED Indicator

- During charging, the red and green LEDs blink alternatively.
- When the battery is fully charged, the orange LED stays lit.
- When the Player uses battery for power, steady red LED lights. If the battery power is low, the red LED blinks.

Cautions in Using Battery Pack

Danger!

Strictly follow these safety information when using the battery pack, otherwise, a short circuit, overheating, smoke, fire, or damage to the product may result.

- Never disassemble or modify the battery pack in anyway. Do not touch the terminal of the battery pack with a metal object.
- Do not place the battery pack in direct sunlight, dashboard of a vehicle, or high temperature place. It can cause explosion or fire.
- Do not expose the battery pack to water, fire, or heat.
- Always use the included AC adaptor when charging the battery pack.
- This battery pack is designed exclusively for your portable DVD player. Do not use it with other devices.

Warning!

1. Do not drop or subject to strong vibration.
2. Keep out of reach of children.
3. The battery pack may leak fluid that is harmful to your eyes.

If this fluid gets in your eyes, wash eyes immediately with large amounts of running water and get medical attention immediately.
If the fluid gets on your skin or clothing, wash immediately with water.

Caution!

1. When not using the battery pack, remove it and store in a cool place.
2. Keep the battery pack free from smoke, steam, moisture, and dust.
3. Using the battery pack under 0 °C (32 °F) or over 40 °C (104 °F) can cause reduced battery life.

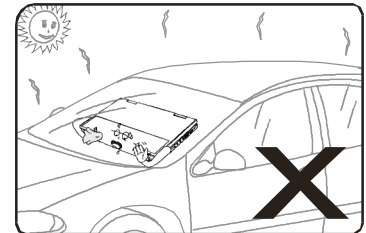

Playing a Disc

Preparation for Playback

1. Make sure the Player has the power either from the battery pack or the AC adaptor.
2. Load a disc, following these steps:
 - Open the top cover.
 - Press the **OPEN** button to open the disc cover.
 - Place a disc into the tray with the label side facing up.
 - Close the disc cover.
3. Slide **POWER** to **ON** to turn on the power.

Play

Press **▶/⏪** (on the remote control) or **▶** (on the player) to start play.

Resume

There are two ways to resume your playback when interrupted.

Method 1: for short time interruption

1. Press **STOP** (**■**), the Player remembers where you stopped.
2. To resume, press **PLAY**, the Player will play from where you stopped.

Method 2: for longer time interruption

1. Press **OPEN** to open the disc compartment door
2. You can turn off the power, and even remove the disc from the desk, when you turn on the power and replace the disc, the Player will play from where you stopped.

Stop

1. Press **■** (on the remote or on the player) to temporarily stop the playback, "**⏸**" appears on the screen.
2. Press **■** again to stop the playback.

Adjusting volume

Press **VOL+** or **VOL-** to change volume.

Skip

You can skip chapters on DVD-Video, tracks on CDs, and Video CDs.

1. To skip forward, press **▶▶** during play, it skips to the next chapter or track. Each press increases the numbers of skips.
2. To skip to previous chapter or track, press **◀◀**.

Fast Forward and Reverse

1. During playback, to fast forward, press and hold **▶▶** (on the player) to increase the fast forward speed 2x, then repeatedly press **▶▶** to increase to 4x, 8x, 16x, 32x. You can also simply repeatedly press **▶▶** on the remote control to increase the fast forward speed.
2. During playback, to fast reverse, press and hold **◀◀** (on the player) to increase the fast reverse speed 2x, then repeatedly press **◀◀** to increase to 4x, 8x, 16x, 32x. You can also simply repeatedly press **◀◀** on the remote control to increase the fast reverse speed.
3. To resume normal playback, press **▶/⏪**.

Playing a Disc

Slow Motion

1. During playback, repeatedly press **SLOW** to play at 1/2, 1/4, 1/8, 1/16, 1/32 speeds.
 2. To resume normal playback, press ▶/⏪.
- You can only perform slow motion play in the forward direction.

Repeat Playback

You can play a chapter, a track, a title, a file or the entire disc repeatedly.

1. During playback, repeatedly press **REPEAT** to choose a Repeat option. Depending on the type of disc, the Repeat options may be different.
2. To cancel repeat playback, repeatedly press **REPEAT** until "⏮ off" appears on the screen.

Mark (Bookmark)

The Mark function lets you "bookmark" points on the disc for playback at a later time. You can store up to 20 bookmark locations.

Follow these steps to set up marker playback:

1. During playback, press **MARK** on the remote control.
2. Use ▲▼ to select a bookmark location.
3. When you reach the scene you want to mark, press ▶/⏪ to confirm.
4. Repeat the above procedure for a new scene. You can have up to 20 bookmarks.

You can perform marker playback at any time by pressing **MARK**, and using ▲▼ to select one of the bookmarks, then

pressing ▶/⏪ to start playing the bookmarked scene. The Playback continues until the end of the disc. Repeat the above to play the other marked scenes.

GOTO

You can go directly to a desired chapter and play, or play at a desired point of time. Follow these steps:

(A) To play a specific chapter

1. Press **GOTO**, use ▲▼ to select title (TT) and chapter (CH) and enter the desired number.
2. Press **ENTER** to confirm and start play.

(B) To play from a specific point of time.

1. Press **GOTO** twice to move to the time display and it changes 00:00:00.
2. Fill in the time (hour: minute: second).
3. Press **ENTER** to confirm and start play.

ZOOM

ZOOM lets you enlarge the video image during playback and pan through the enlarged image.

1. Press **ZOOM** repeatedly during video playback to enlarge the image to 2 or 4 times of the normal size.
 2. Press **ZOOM** repeatedly while displaying JPEG file and Picture CD disc to zoom in the picture at 150% or 200% and zoom out the picture at 25% or 50%.
- Use direction keys (▲▼ and ◀▶) to move around (pan and scan) the enlarged video or picture.

Playing a Disc

Mute

Press **MUTE** to silence the audio, press **MUTE** again to restore it.

Menu/PBC

During DVD playback, press **MENU/PBC** to return to the disc's Start Menu. If the disc does not have the Start Menu, or discs that refuse MENU function,  appears.

For VCD playback, press **MENU/PBC** to turn on/off PBC (Playback Control). If PBC is enabled, menu of scene's thumbnails appears, you can make selection for playback.

LANGUAGE

Repeatedly press **LANGUAGE** during DVD playback to change the language of the voice if the disc has multiple languages. This function is only valid for DVDs.

Subtitle

Repeatedly press **SUBTITLE** during DVD playback to change the subtitle's language if the disc has multiple subtitle's languages. This function is only valid for DVDs.

Angle

Repeatedly press **ANGLE** during DVD playback to change the camera angle if the disc has different camera angles. This function is only valid for DVDs.

TITLE

Press **TITLE**, it takes you to the very beginning of the title and play, or to the **MENU** if it has title menu.

DISPLAY

Repeatedly press **DISPLAY** during playback to display various playback information such as current title, chapter, track elapsed time, languages etc.

L/R

This function is mostly used for karaoke (sing along) discs, by repeatedly pressing L/R, you can select STEREO, MONO (Left), MONO (Right), MIX MONO etc.

P/N

This is used when you connect the Player to a TV and watch video on the TV. Repeatedly press P/N to select NTSC, PAL and AUTO to match that of your TV. The LCD screen does not have NTSC or PAL, so if you watch video on the Player's screen, it is recommended to set to NTSC which will give a better video quality. The player will play both PAL or NTSC DVD's titles even when the Player is set to NTSC.

Playing Mp3 and Regular Audio CD

Valid MP3 CD

Your MP3 files should be ISO 9660 or JOLIET format.

Play

In most cases, when a MP3 or audio disc is placed into the player, the first song file of the first folder plays.

In other cases, the file manager appears. Use direction keys (▲▼ and ◀ ▶) to select the song file and press ▶/↵ to play.

Playing Picture CD

Valid Picture

The player can play both Kodak Picture CD that you order from photo processing store, and home-made CD by burning JPEG files onto a CD-R or CD-RW disc.

Play

In most cases, after the disc is placed into the player, the first file will be shown.

In other cases, the file manager appears. Use direction keys (▲▼ and ◀▶) to select the picture and press **PLAY ▶** on the Player or ▶/↵ on the remote control to start the slide show (plays photos automatically).

- To return to file manager, press MENU/PBC.
- To display thumbnail, press "■" during playback of images.
- To start slide show, press "▶" during playback of images.

Press **ZOOM** to enlarge the photo and use ▲▼ and ◀▶ to move around the enlarged photo. The slide show function stops when you press **ZOOM**.

Next/Previous

You can manually skip to the next picture by pressing ▶▶, and to skip to the previous picture by pressing ◀◀.

Rotate

The picture can be rotated and flipped.

1. During playback, use direction keys (◀▶ and ▲▼) to rotate right 90 degrees, left 90 degrees, flip vertically and horizontally respectively.

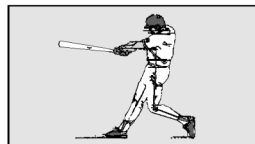

Original

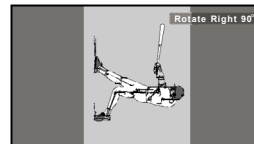

Rotate right 90 degrees

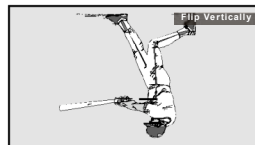

Flip vertically

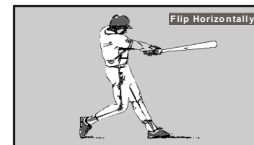

Flip horizontally

Displaying and Sorting Files

Displaying files

When a disc or USB device contains multiple filetypes, you can select and display only certain file types.

1. Press **STOP** ■ and select **FILE TYPE** and press "►/←" to confirm.
2. Select the file type you do not want to display and repeatedly press "►/←" so the check mark disappears.
3. Repeat STEP 2 to hide the other filetype.
4. Select **EXIT** and press "►/←" to get out.

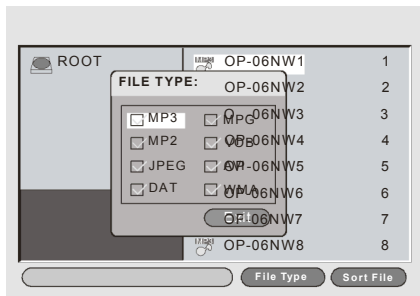

Sorting files

You can list the file in the order according to its type, name or date.

1. Press **STOP** ■ and select **SORT FILE**, press "►/←" to confirm.
2. Select one of the sorting criteria (by type, by name and by date).
3. Select Ascending or Descending order for listing the files, press "►/←" to confirm.
4. Select **EXIT** and press "►/←" to get out.

NOTE: If the file is listed by name, It will first list the file names with capital letter in alphabetical order, then files with lower case.

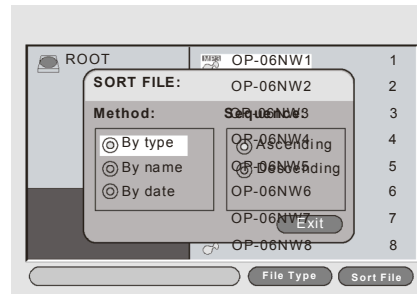

Setting Language for OSD, Menu, Audio, Subtitle

1. Press **SETUP** on the remote control.
2. Use the direction keys (◀▶) to select **Language Setup** and its sub-menu.
3. Press ▶/↵ to confirm your selection.
4. Press **SETUP** to exit.

Changing OSD language

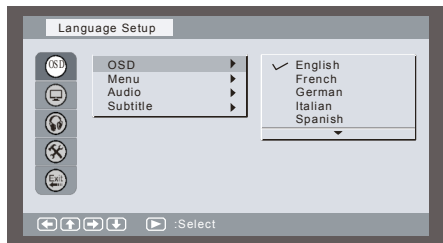

Changing menu language

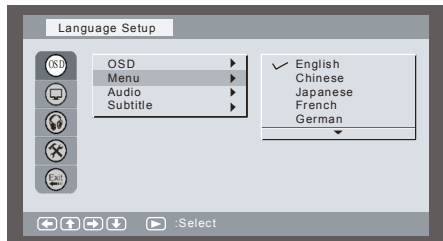

Changing voice language

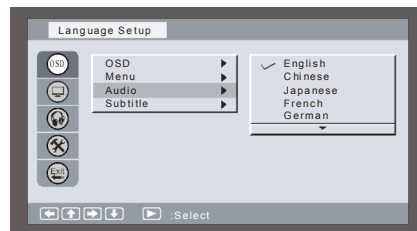

Changing subtitle language



Setting Screen for Display Format, Screen Saver, TV System

1. Press **SETUP** on the remote control.
2. Use the direction keys (◀▶▶▶) to select **Screen Setup** and its sub-menu.
3. Press ▶/↵ to confirm your selection.
4. Press **SETUP** to exit.

Adjusting the Aspect Ratio

- **4:3 LB (LetterBox)**
Displays the content of the DVD title in 16:9 aspect ratio.
The black bars will appear at the top and bottom of the screen.
- **4:3 PS (PanScan)**
The left and right of the screen are cut off and displays the central portion of the 16:9 screen.

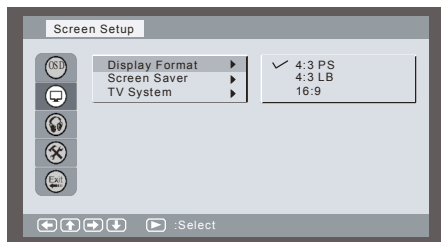

Turning on/off screen saver

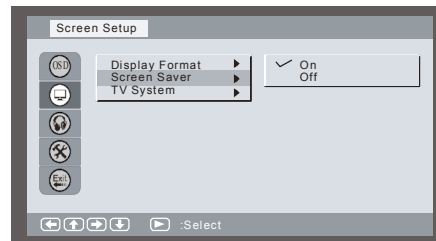

Selecting TV system

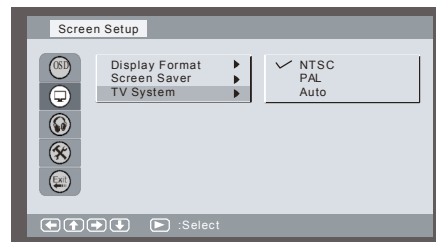

Setting Audio for Downmix

1. Press **SETUP** on the remote control.
2. Use the direction keys (◀▲▼▶) to select **Audio Setup** and its sub-menu.
3. Press ▶/↵ to confirm your selection.
4. Press **SETUP** to exit.

Changing Digital Out

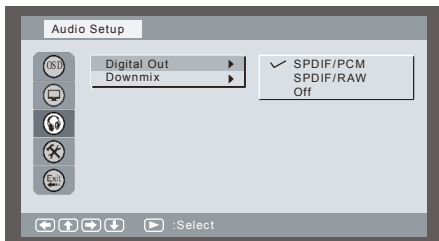

Note:

SPDIF/OFF:select this when you do not want to have digital audio signal output.

SPDIF/RAW:select this when the digital audio output is connected to an external amplifier with Dolby Digital or DTS decoder which gives 5.1 channel sound.

SPDIF/PCM:select this when the external amplifier has no decoder.

Changing Downmix

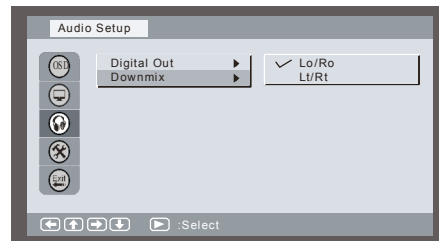

Setting Parental Control, Password, Camera Angle, Default

1. Press **SETUP** on the remote control.
2. Use the direction keys (◀▲▼▶) to select **Custom Setup** and its sub-menu.
3. Press ▶/↵ to confirm your selection.
4. Press **SETUP** to exit.

Setting parental control

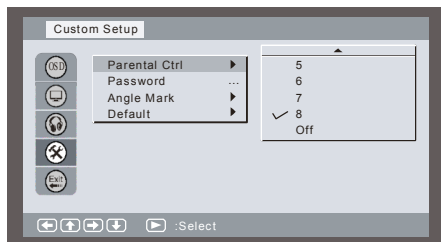

Turning on/off camera angle

When ON is selected, the player will display multi-angle mark on the screen if the disc has multi-angle shot.

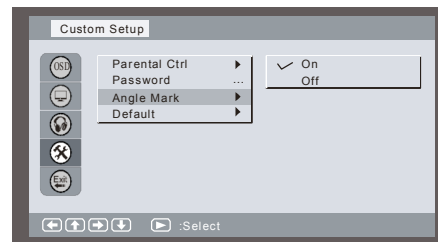

Changing password

1. Use directionkeys (◀▲▼▶) to select Password and press **ENTER** to confirm.
2. Key in your old password (8888 if this is the first use).
3. Key in new password and again to verify.

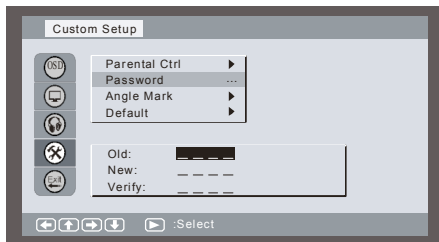

Returning to default setting

All settings will revert to the original factory settings when Reset is selected.

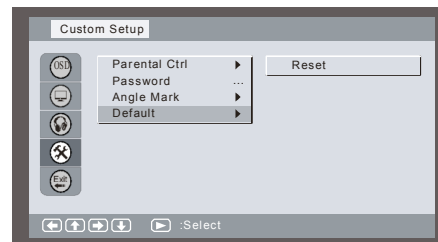

Adjusting LCD Screen

You can adjust screen's Brightness, Contrast, Color, as well as to reverse the screen image 180 degrees.

Adjusting Brightness, Contrast and Color

1. Press and hold **MENU/PBC/LCD adj.** for a few seconds to display the adjustment menu.
2. Use **▲▼** to select the Brightness (☼), Contrast (◆), Color (RGB), and use **◀▶** to make the adjustment, Press **ENTER** to confirm.

Choosing the aspect ratio

1. Press and hold **MENU/PBC/LCD adj.** for a few seconds to display the Adjustment Menu.
2. Select **16:9/4:3** and press **ENTER** to confirm.

Reversing the screen

1. Press and hold **MENU/PBC/LCD adj.** for a few seconds to display the adjustment menu.
2. Select **REVERSE** and press **ENTER** to confirm.

Resetting screen setting to default value

1. Press and hold **MENU/PBC/LCD adj.** for a few seconds to display the adjustment menu.
2. Select **RESET** and press **ENTER** to confirm.

Note: If no key is pressed for 3~4 seconds, the Menu disappears.

Troubleshooting

If your DVD player does not seem to be functioning properly, check the items below before you contact a service center.

Symptom	Check
Power does not turn on or suddenly turns off	Make sure the AC Power cord is securely plugged into an AC outlet. Turn the power off and then back on.
Battery pack is in place but the power does not turn on or suddenly turns off	Check that the battery pack is charged. If not, recharge it.
Remote control does not work	Check that the battery is inserted in the "+" and "-" directions properly. The batteries may be dead. Replace them with new batteries. Check that the signal transmission is directed at the remote control sensor on the DVD player.
Disc does not play	Check that the disc is a DVD, DVD-RW, VIDEO CD, or AUDIO CD. Do not use a disc that has scratches or dirt. Check that the label-side of the disc is facing up. The pick-up lens of the DVD player may be dirty. Contact the service center for lens cleaning.
No picture	Check if the LCD on/off switch is stuck, and cannot move freely when the top cover is open.
No sound	Check the volume setting. If set to zero, turn up volume level. Check that the headphones are plugged into the PHONES and Audiojack. Speakers cannot be used with the headphones.

Troubleshooting

Symptom	Check
While in the input mode, no picture is output from the external component to the DVD player	Check that the video or audio cable is securely connected.
Battery pack won't charge	Check that the DVD player is turned on. You cannot charge the battery pack with the player turned off. A hot battery pack may take longer to charge. Wait until the battery pack is sufficiently cooled down.
Charging LED indicator does not light	Check with another fully charged pack if the LED lights. Check that the AC adaptor is securely plugged in. If DVD or battery pack is overheated, you will not be able to charge the battery pack.
On charging the depleted battery, the red and green LED charging indicators quickly light, indicating battery is fully charged, but in fact it is not	Disconnect the AC adaptor and reconnect to make sure the connection is OK. Use another battery pack, if the same symptom occurs, the AC adaptor may be defective. If the second battery pack charges without any problem, your first battery pack may be defective.

Specifications

General	Power Requirements	Input AC 100V~240V, 50/60 Hz, Output DC 12V
	Power Consumption	≤ 15 W
	Weight	1041g (without battery pack)
	Dimensions	255mm (W) x 179mm (D) x 32.2mm (H)
	Operating Temperature Range	+10° C~ +40° C
Readable Disc	DVD, DVD-R, DVD+R, DVD-RW, DVD+RW, VCD, CD, HDCD, Picture CD, CD-R, CD-RW, MPEG4, MP3, WMA.	
Readable USB	DSC, Camcorder, U-drive, MP3 player, and other USB storage devices	
Video Output	Composite Video	1 channel : 1.0 Vp-p (75 Ω load)
Audio Output	2 Channel	L(1/L), R(2/R)
	Frequency Response	20Hz - 20 kHz ± 2.5dB
	S/N Ratio	≥ 85 dB
	Dynamic Range	≥ 80 dB

Battery Specifications

ITEM	SPECIFICATION
Nominal Voltage	7.4V
Max Charge Current	1A
Use Time	~2.5HR
Charging time to Full capacity	2.5HR

Operating environment

Charge	0° C~ +45
C Discharge	-20° C~ +60
C Store less than 1 month	-20° C~ +60
C Store less than 3 months	-20° C~ +45
C Store less than 1 year	-20° C~ +25

C

-
- The specifications are subject to change without notice.
- Weight and dimensions are approximate.

Due to continued product improvements, if there is any discrepancy in this user manual, the actual unit prevails.

Call Element Electronics Toll Free Tech support # at 1 888-319-9464

LIMITED WARRANTY

The Manufacturer warrants that this product is free of defects in both workmanship and material. This warranty lasts for ninety days from purchase of the product. The Manufacturer will replace the defective product with the same or a model with substantially the same features and function. In order to be eligible for service, you must return the defective product to the store where it was purchased. Proof of purchase is required.



If at anytime in the future you should need to dispose of this product please note that: Waste electrical products should not be disposed of with household waste. Please recycle where facilities exist. Check with your Local Authority or retailer for recycling advice. (Waste Electrical and Electronic Equipment Directive)