

6. DVD VIDEO SYSTEM

DVD video is a high-quality digital video source that provides crisp and clear images. One 12 cm disc contains either one film or four hours of music.

DVD Video Features

This unit provides the following functions in addition to the high image quality and sound quality of DVD video.

Notes:

- The functions described in the section, "Features", for example, the recorded language, subtitles, angles, etc. differ with the DVD video disc. Refer to the instructions provided with the DVD video.
- Some disc functions may operate differently than described in this manual.

Multi-sound function

DVD video can store up to 8 languages for one film; select the language of your preference.

- The languages stored on the disc are indicated by the icon shown below.



Multi-angle function

A DVD video that is filmed from multiple angles allows you to select the angle of choice.

- The number of recorded angles are indicated by the icon shown below.

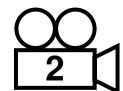

Subpicture (subtitles) function

A DVD video can record subtitles for up to 32 languages and you can select the language of the subtitles you wish to see.

- The number of recorded subtitle languages are indicated by the icon shown below.



Multi-story function

When a DVD video contains more than one story for a film, you can select the story you wish to enjoy. The operation procedures vary with the disc; observe the instructions for selecting a story provided during playback.

Dolby digital

Dolby digital enables up to 5.1 independent multi-channel audio reproduction, the same type of surround system that is also used in movie theaters.

DTS

DTS (Digital Theater System) is a sound system that differs from the Dolby digital system. DTS provides a larger amount of data than Dolby digital enabling high-quality surround playback and incorporates a DTS-CD software for music like a DVD software allows 5.1 channel independent multi-channel audio reproduction.

Menu screens

Menus can be called up during DVD video playback to perform menu setting.

- Example showing menu display

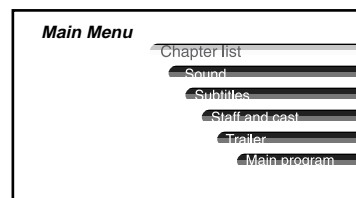

2. PRECAUTIONS

WARNING

For your safety, the driver should not watch the TV or operate the controls while driving. Please note that watching and operating the TV while driving are prohibited by law in some countries. Also, while driving, keep the volume to a level at which external sounds can be heard.

1. When the inside of the car is very cold and the player is used soon after switching on the heater, moisture may form on the disc or the optical parts of the player and proper playback may not be possible. If moisture forms on the disc, wipe it off with a soft cloth. If moisture forms on the optical parts of the player, do not use the player for about one hour. The condensation will disappear naturally allowing normal operation.
2. Driving on extremely bumpy roads which cause severe vibration may cause the sound to skip.
3. This unit uses a precision mechanism. Even in the event that trouble arises, never open the case, disassemble the unit, or lubricate the rotating parts.

This equipment has been tested and found to comply with the limits for a Class B digital device, pursuant to Part 15 of the FCC Rules. These limits are designed to provide reasonable protection against harmful interference in a residential installation. This equipment generates, uses, and can radiate radio frequency energy and, if not installed and used in accordance with the instructions, may cause harmful interference to radio communications. However, there is no guarantee that interference will not occur in a particular installation. If this equipment does cause harmful interference to radio or television reception, which can be determined by turning the equipment off and on, the user is encouraged to consult the dealer or an experienced radio/TV technician for help.

MODEL **clarion**

12V GROUND

Apparatus Claims of U.S. Patent Nos. 4,631,603, 4,577,216, 4,819,098 and 4,907,093 licensed for limited viewing uses only.

Manufactured under license from Dolby Laboratories, "Dolby" and the double-D symbol are trademarks of Dolby Laboratories, Confidential unpublished works, © 1992-1997 Dolby Laboratories. All rights reserved.

CAUTION

1. Be sure to use the screws, etc., included in the package for installation. Using other screws could damage the set.
2. Set the selectors on both side panels to the "H" Position when installing the set horizontally, to the "V" position when installing the set vertically. When installing at the angle of 45°, set the selectors to the center click position. The set may be damaged if the selectors are not set to the proper positions.

THIS DEVICE COMPLIES WITH PART 15 OF THE FCC RULES. OPERATION IS SUBJECT TO THE FOLLOWING TWO CONDITIONS: (1) THIS DEVICE MAY NOT CAUSE HARMFUL INTERFERENCE, AND (2) THIS DEVICE MUST ACCEPT ANY INTERFERENCE RECEIVED, INCLUDING INTERFERENCE THAT MAY CAUSE UNDESIRABLE OPERATION.

THIS PRODUCTION COMPLIES WITH DHHS RULES 21 CFR SUBCHAPTER J APPLICABLE AT DATE OF MANUFACTURE.

CLARION CO., LTD. 50 KAMITODA, TODA-SHI, SAITAMA-KEN, JAPAN.

MANUFACTURED:

SERIAL No.
PE-

29C-
Clarion Co., Ltd.
MADE IN

INFORMATION FOR USERS:

CHANGES OR MODIFICATIONS TO THIS PRODUCT NOT APPROVED BY THE MANUFACTURER WILL VOID THE WARRANTY AND WILL VIOLATE FCC APPROVAL.

3. HANDLING DISCS

To remove the disc from its storage case, press down on the centre of the case and lift the disc out, holding it carefully by the edges.

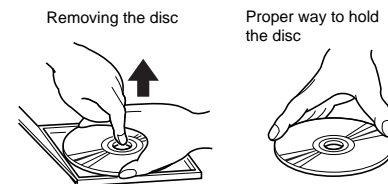

Always handle the disc by the edges. Never touch the surface.

To remove fingermarks and dust, use a soft cloth, and wipe in a straight line from the centre of the disc to the circumference.

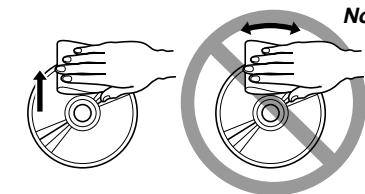

New discs may have some roughness around the edges. The unit may not work or the sound may skip if such discs are used. Use a ball-point pen, etc. to remove roughness from the edge of the disc.

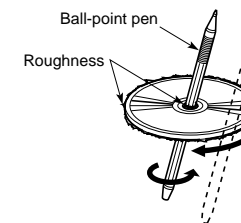

Note on Discs

Never stick labels on the surface of the disc or mark the surface with a pencil or pen.

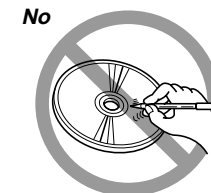

Do not use any solvents such as commercially available cleaners, anti-static spray, or thinner to clean discs.

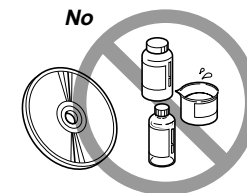

Do not use discs that have large scratches, are misshapen, or cracked, etc. Use of such discs will cause misoperation or damage.

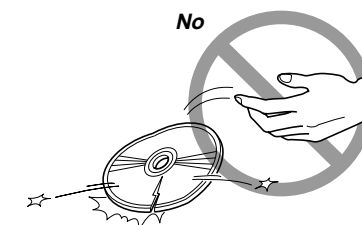

Do not expose discs to direct sunlight or any heat source.

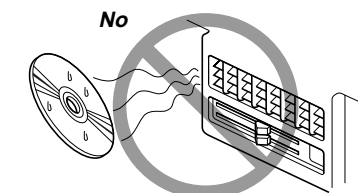

Note:

- Do not use commercially available disc protection sheets or discs equipped with stabilizers, etc. These may get caught in the internal mechanism and damage the disc.

Be sure to unfold and read the next page. / Veuillez déplier et vous référer à la page suivante. / Cerciórese de desplegar y de leer la página siguiente.

4. REMOTE CONTROL / TÉLÉCOMMANDE / CONTROLADOR REMOTO

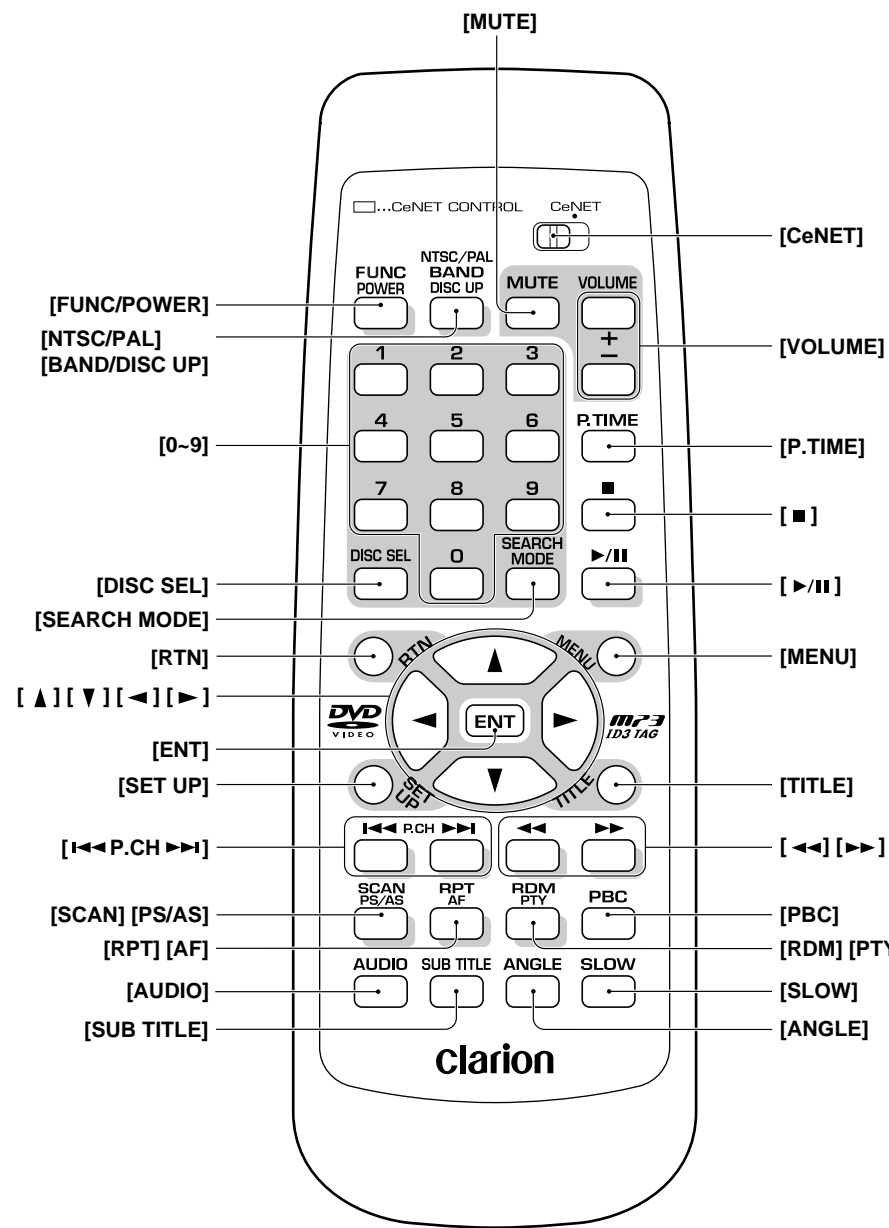

5. COMPONENTS AND FUNCTIONS

Remote control unit

[FUNC/POWER] button*
(Used for CeNET only)

[NTSC/PAL] [BAND/DISC UP] button*
(Video output select button)
Used to switch among NTSC, PAL, and MULTI by pressing the button for 1 second or longer.

*When a disc is changed, initial setting is returned.

[CeNET] switch (Mode select switch)
Set this switch to the left side for standalone mode or right side for CeNET connection.

[MUTE] button*
Turns mute on and off.

[VOLUME] buttons*
Press "+" button to increase the volume.
Press "-" button to decrease the volume.

[P. TIME] button
Used to switch among play time displays.

[■] button (STOP button)
Stops video and audio playback.

[▶/II] button (Play/pause button)*
Press this button to play or pause a disc

[0~9] buttons (Ten-key buttons)
Used to input numbers.

[DISC SEL] button
Used to change the disc.
Enter with this key and numeric keys.

[MENU] button
V-CD (with PBC): Displays the PBC menu.
MP3: Returns the cursor to the default position and displays the track select screen.
DVD VIDEO: Displays the menu screen.

[RTN] button
Returns to the previous menu.

[◀][▶][▲][▼] buttons (cursor buttons)
When selecting the menu items shown in the monitor screen, use the cursor buttons to move the cursor up and down, left and right.

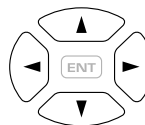

[ENT] button
Press this button to enter the setup item.

[TITLE] button
DVD VIDEO: Displays the title screen.

[SET UP] button
Displays the setup screen of the unit.

[◀◀ P.CH ▶▶] buttons*
Used to search for a scene or track.

[▶▶] [◀◀] buttons (Fast forward and Fast rewind buttons)*
While the button is kept pressed, fast forward/fast rewind is performed.

[SCAN] [PS/AS] button*
Turns on/off scan playback.

[RPT] [AF] button*
Turns on/off repeat playback.

[RDM] [PTY] button*
Turns on/off random playback.

[PBC] button
Turns on/off the playback control (PBC) function for V-CDs equipped with it

[AUDIO] button
DVD VIDEO: Switches among languages for audio (for DVDs with two or more languages).
V-CD: Switches among audio output methods.

[SUB TITLE] button
Switches among languages for the subtitle.

[ANGLE] button
Switches among angles while in DVD playback.
(This button is available only on multiple angles DVDs.)

[SLOW] button
While the button is kept pressed, slow play is performed.

[SEARCH MODE] button
After this button is pressed, enter numbers using Ten-key buttons.

DVD VIDEO: Performs searching with a title/chapter number.
MP3: FOLDER/TRACK number.
V-CD (key inputs are accepted only when the PBC is turned off.): TRACK number
CD: TRACK number.

* When the unit is connected to the center unit and the [CeNET] switch is set to the CeNET position, some functions of the center unit can be controlled from this unit.

Operating button	Function
[FUNC/POWER] button ([FNC] button)	Mode Switching/Power On/off
[BAND/DISC UP] button ([BND] button)	Band Switching/Disc up
[MUTE] button ([MUTE] button)	Mute On/off
[VOLUME] button ([ROTARY] Knob)	Volume Adjustment
[▶/II] button ([▶II] button)	Play/Pause
[SCAN] [PS/AS] button ([SC] button)	Auto Store/Preset Scan
[RPT] [AF] button ([RP] button)	Repeat/AF On/off
[RDM] [PTY] button ([RD] button)	Random/PTY On/off
[◀◀ P.CH ▶▶] buttons ([◀◀], [▶▶] buttons)	Search Up/Down
[▶▶], [◀◀] buttons (Press and hold the [◀◀], [▶▶] buttons for 1 second or longer)	Fast Forward/Fast Rewind

• For a detailed information, refer to the Owner's Manual provided with the center unit.

Source unit

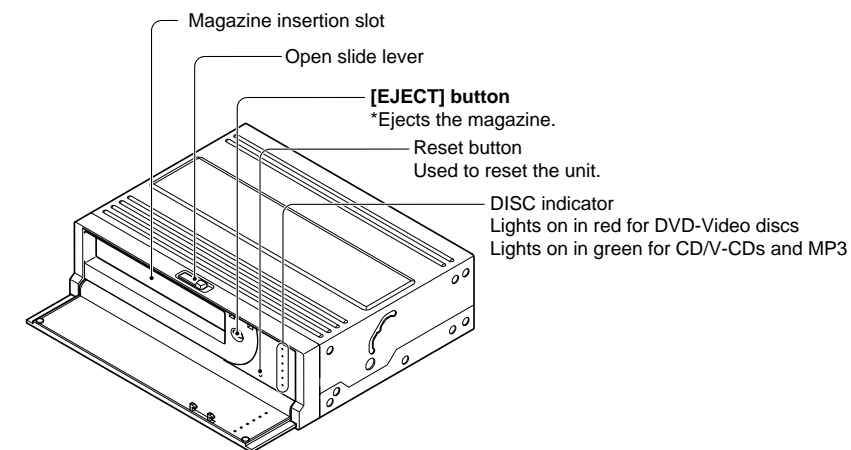

Remote control receiver

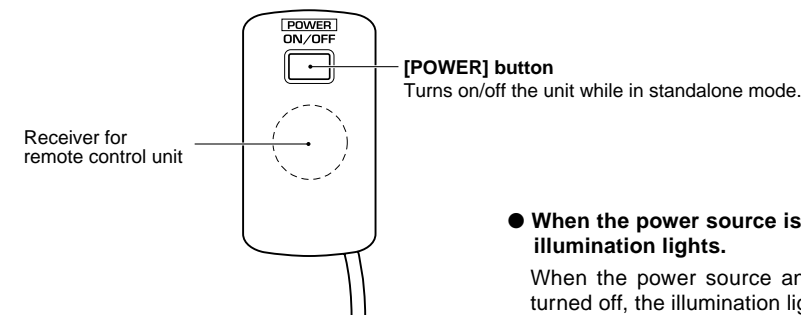



● When the power source is turned on, the illumination lights.

When the power source and the ACC are turned off, the illumination lights for a while.

Discs

Playable discs

This DVD video player can play the following discs.

Playable disc		
DVD video discs	video CDs	Audio CDs
		

Note:

- When you play a CD Extra disc, only the first session will be recognized.

About CD Extra discs

A CD Extra disc is a disc in which a total of two sessions have been recorded. The first session is Audio session and the second session Data session.

Your personally-created CDs with more than 2 data sessions recorded cannot be played on this DVD video player.

About playing a CD-R/CD-RW disc

This player can play CD-R/CD-RW discs previously recorded in music CD format or video CD format.

Discs that cannot be played back

This DVD video player cannot play back DVD-R, DVD-RAM, Photo CDs, etc.

Notes:

- It may also not be possible to play back CDs recorded on a CD-R unit and CD-RW unit.
(Cause: disc characteristics, cracks, dust/dirt, dust/dirt on player's lens, etc.)
- If a CD-R or CD-RW disc that has not been finalized is played, it will take a long time to start playing. Also, it may not be possible to play depending on its recording conditions.

Note on region numbers

The DVD video system assigns a region number to DVD video players and DVD discs by sales area. DVD video players sold in the United States can play back DVD discs with the region number "ALL", "1" or any combination of numbers that also incorporate a "1".

The DVD video region number is marked on the disc jacket as shown below.



NTSC



NTSC



NTSC

TV color system

This DVD player plays NTSC discs and PAL discs only and cannot be used for playback of SECAM discs.

About MP3 playback

This unit can play back CD-R/CD-RW discs on which MP3 music data have been recorded.

For a detailed information, see the page entitled "Listening to an MP3"

Auto disc change

This unit auto disc changes only audio CDs.

For example:

If an audio CD is loaded in the DISC 1 slot, a DVD disc in the DISC 2 slot and an audio CD in the DISC 3 slot, disc change is performed shown below.

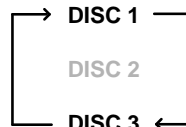

About the registered marks etc.

• This product incorporates copyright protection technology that is protected by method claims of certain U.S. patents and other intellectual property rights owned by Macrovision Corporation and other rights owners. Use of this copyright protection technology must be authorized by Macrovision Corporation, and is intended for home and other limited viewing uses only unless otherwise authorized by Macrovision Corporation. Reverse engineering or disassembly is prohibited.

• Manufactured under license from Dolby Laboratories.

“Dolby” and the double-D symbol are trademarks of Dolby Laboratories. Confidential Unpublished Works. ©1992-1997 Dolby Laboratories, Inc. All rights reserved.

• Manufactured under license from Digital Theater Systems, Inc. US Pat. No. 5,451,942, 5,956,674, 5,974,380, 5,978,762 and other world-wide patents issued and pending.

Remote control

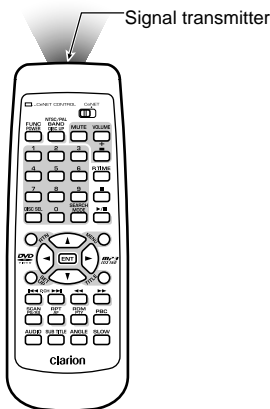
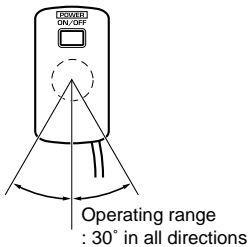

Replacing the batteries

1. Open the rear battery cover.

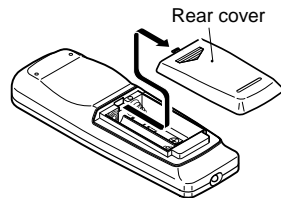

2. Insert the two supplied size AA batteries orienting the plus and minus poles of the batteries as shown by the ⊕ and ⊖ symbols inside the battery compartment. Close the battery cover.

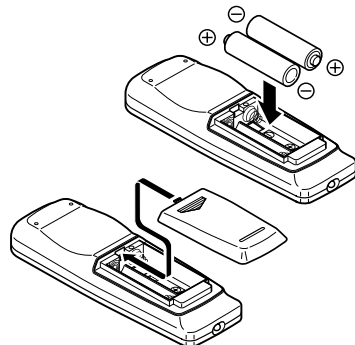

Notes:

Using batteries improperly can cause them to explode. Take note of the following points:

- When replacing batteries, replace both batteries with new ones.
- Do not short-circuit, disassemble or heat batteries.
- Do not dispose of batteries into fire or flames.
- Dispose of spent batteries properly.

7. PREPARATION (Setting a Disc)

Setting a disc into the magazine

Inserting the disc

1. Put your finger on the disc holder release knob and draw out the disc holder.

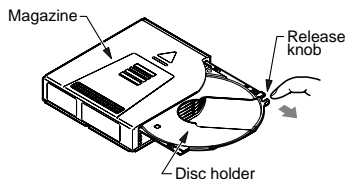

2. Insert a disc into the concave portion of the disc holder with its label side (printed side with a title, etc.) facing up.

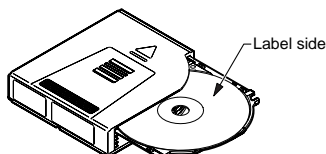

3. Press in on the disc holder until it locks securely into the magazine. After loading a disc, make sure that it is correctly loaded.

CAUTION

Look through the magazine opening and check whether or not the disc is tilted.

If the disc holder does not slide in fully, or slides with difficulty, it is possible that the disc is not correctly loaded. Reload in such cases.

CAUTION

Pulling strongly on the disc holder may cause it to come out of the magazine. In such cases, press in on the disc holder tabs and re-insert into the magazine. Be sure that the disc holder is correctly inserted.

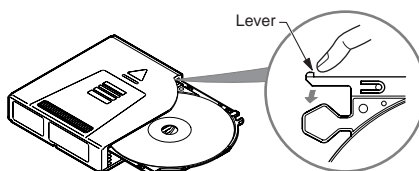
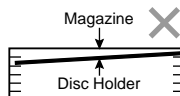

Extracting the disc

Take out the disc after pulling out the disc holder.

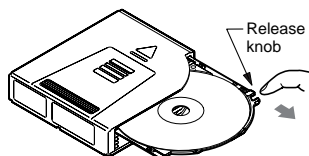

Note:

- When taking out the disc do not let your fingers touch the signal side of the disc.

■ Setting the Magazine into the Unit

Inserting the Magazine

1. Slide the open slide lever to right (to open the front door).
2. When using the unit in a vertical position, open the front door completely by hand.

Setting a disc into the magazine

3. Insert the magazine (facing up as shown below) into the unit with the disc load/unload side on the right. Press the magazine into the unit until it locks securely.

(After the presence of the disc is checked, playback of the disc starts.)

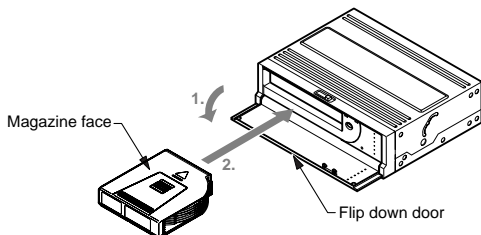

4. Close the front door.

Extracting the Magazine

1. Press the [EJECT] button and take out the magazine.
2. Close the front door.

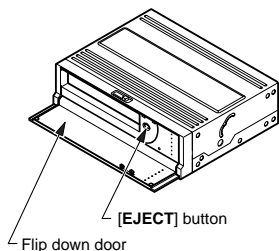

⚠ CAUTION

Dust and other objects may cause malfunctions if they get into the unit.

Always be sure to shut the front door once finished with loading or unloading the magazine.

8. OPERATION

Basic Operations

■ Using the unit separately

Confirm that the CeNET/STANDALONE select switch on the backside of the unit is set to the STANDALONE side.

Confirm that the CeNET/STANDALONE select switch on the remote control unit is set to the STANDALONE side.

Turning on the power

Note:

- To prevent the car battery from running out, perform operations on the unit with the car engine running.

Press the [POWER] buttons on the remote control receiver.

When the message "NO MAGAZINE" is displayed in the screen, load a magazine into the main unit.

After disc checking operation, playback of the disc starts.

When the message "NO DISC" is displayed in the screen, remove the magazine and load a disc into the magazine.

This may take time as the unit performs detailed disc checking to light on the disc indicator.

● To turn off the power

Press the [POWER] button.

The unit is turned off and the indicator on the receiver for remote control unit goes off.

Selecting a disc

Press the [DISC SEL] button on the remote control unit.

Press the numeric button for the disc number (1 to 6) that you want to select.

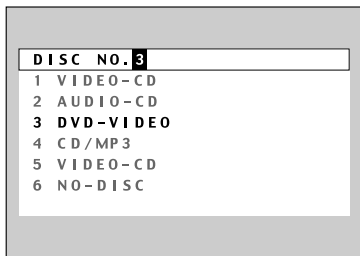

When a disc is switched to some other disc, the newly-selected disc plays automatically.

If you want to return to the original mode, press the [DISC SEL] button again.

Adjusting the volume

⚠ WARNING

DVD-Videos may be played back with particularly loud sound. Increase the volume gradually from the minimum after the video images are displayed.

Press the [VOLUME] button on the remote control unit.

[+] : Increases the volume.

[-] : Decreases the volume.

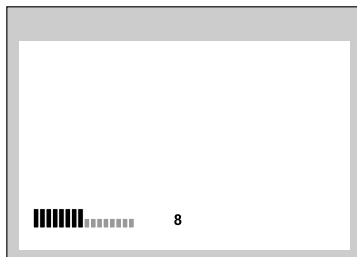

Turning off the sound (mute)

Press the [MUTE] button on the remote control unit.

The monitor displays "MUTE".

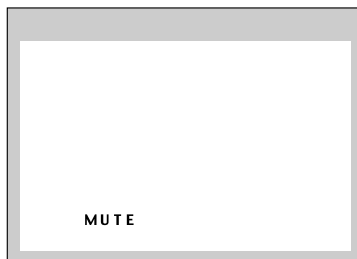

● To restore the volume

Press the [MUTE] button again.

DVD-Video Operations

Watching a DVD-Video

After disc selection, the play mode is automatically engaged.

- Button operation may not be allowed depending on the story of the disc.

■ After the menu screen is displayed

For normal DVD-Video discs, the menu screen appears.

After the menu screen is displayed, select an item in the following operations and play it back.

Selecting the DVD menu

1. Press the [MENU] button during playback.

→The DVD menus appears.

The displayed contents may differ, depending on the DVD software.

- Example showing menu display

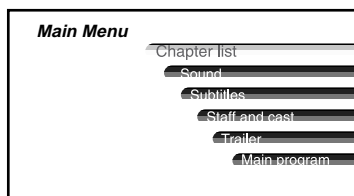

2. Select an item by pressing “▲” and “▼” buttons and press the [ENT] button to enter.

Otherwise, select an item with the ten-key buttons on the remote control unit and press the [ENT] button to enter.

→The video images of the selected item are played back.

- Depending on the disc, items cannot be selected with the ten-key buttons.

Stopping playback

Press the Stop [■] button during playback.

→Playback stops.

■ To resume playback

- Press the Play/pause [▶/||] button, and playback resumes from the scene where playback is stopped.

Pausing playback

Press the Play/pause [▶/||] button during playback.

→Playback pauses.

■ To resume playback

- Press the Play/pause [▶/||] button, and playback resumes.

Slow playback

Press and hold [SLOW] button.

→While the button is being pressed, slow playback continues at the speed 1/2 times the normal playback.

- Slow playback cannot be performed in the backward direction. In addition, audio cannot be reproduced during slow playback.

Skipping a chapter (searching)

About chapter

Chapter means a small segment to divide the data area of the disc.

Press the Chapter up [▶▶|] button or Chapter down [|◀◀] button during playback.

→Chapters are skipped, as many as the times the button is pressed, and playback starts.

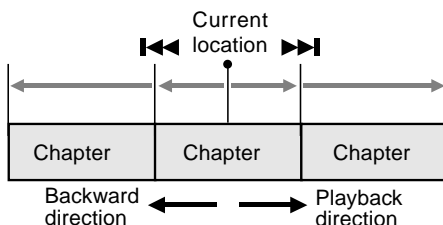

- Press the [▶▶|] button, and playback starts from the beginning of the next chapter.
- Press the [|◀◀] button, and playback starts from the beginning of the current chapter. When this button is pressed again within about 2 seconds, playback starts from the beginning of the previous chapter.
- The unit may return to the menu screen when the [▶▶|] button or [|◀◀] button is pressed.

Fast forward and fast rewind

Press and hold the Fast forward [▶▶] button or Fast rewind [◀◀] button during playback.

- Press and hold the button, and the playback speed becomes 4-time faster first and then 16-time faster 3 seconds later. Release the button, and the normal speed is restored.
- No audio is reproduced during fast forward and fast rewind operation.
- The fast forward and fast rewind speed may differ depending on the disc.
- The menu screen may appear when the button is pressed.

Searching with a chapter/title number

You can locate the beginning of the scene using the chapter numbers or title numbers recorded on the DVD-Video disc.

1. Press the [SEARCH MODE] button during playback and select “[C**]”.

→ Each time you press the button, you can switch between title number input “[T**]” and chapter number input “[C**]”.

• Title

A large segment to divide the data area of the disc.

• Chapter

A small segment to divide the data area of the disc.

2. Input the number of the title that you want to play back with the ten-key buttons (0 to 9).
 - To input the title number “12”, press “1” of then key buttons and then “2”.

Press “1”.

Press “2”.

3. Press the [ENT] button.

- Playback starts from the scene of the input title number or chapter number.
- If the input title number does not exist or searching with a title number is not allowed, the following message appears to invalidate the input.

 INVALID

Scan playback

Scans and plays back all chapters recorded on the DVD-Video, the first 10 seconds for each.

Press the [SCAN] button.

After scan playback of all chapters on the disc, chapter scanning through the same disc is performed again.

Depending on the disc, the menu may appear again after scan playback of all chapters within the title.

Press the [SCAN] button again, and scan playback is turned off.

Depending on a chapter previously set, SCAN may be cancelled.

Repeat playback

This operation plays back chapters/titles recorded on the DVD-Video repeatedly.

Press the [RPT] button for chapter repeat.

Press the [RPT] button for 1 second or longer for title repeat.

● Chapter repeat:

Plays back one chapter repeatedly.

● Title repeat:

Plays back all chapters within the title repeatedly.

Press the [RPT] button again, and repeat playback is turned off.

Using the title menu

On DVD discs containing two or more titles, you can select from the title menu for playback.

1. Press the [TITLE] button during playback.

→ The title menu screen appears.

- Press the [MENU] button, and playback resumes from the scene played back before [TITLE] button is pressed.
- Depending on the disc, the title menu cannot be called with [TITLE] button.

2. Press the “▲” and “▼” button or use the ten-key buttons to select an item.

- Movement of the selected item with the jog differs depending on the disc. Selection using the ten-key buttons also differs depending on the disc.
- Depending on the disc, items cannot be selected with the ten-key buttons.

3. Press the [ENT] button.

Switching among languages

On discs in which two or more audios or audio languages have been recorded, you can switch among the audio languages during playback.

Press the **[AUDIO]** button during playback.

- Each time you press the button, you can switch among audio languages.
- Depending on the disc, up to 8 audios may be recorded. For details, see the mark of the disc (8): Indicates that 8 audios have been recorded).
- When the power is turned on and when the disc is changed with a new one, the language set at the time of factory shipment is selected. If that language has not been recorded, the language specified on the disc.
- Depending on the disc, switching may be completely impossible or impossible on some scenes.
- It may take time to switch among audios.

Switching subtitles

On DVD discs in which two or more subtitle languages have been recorded, you can switch among the subtitle languages during playback.

Press the **[SUB TITLE]** button during playback.

- Each time you press the button, you can switch among subtitles.
- Depending on the disc, up to 32 kinds of subtitles may be recorded. For details, see the mark of the disc (32): Indicates that 8 kinds of subtitles have been recorded).
- Depending on the disc, switching may be completely impossible or impossible on some scenes.
- It may take time to switch among subtitles.

● To turn off subtitles

Press the **[SUB TITLE]** button several times, and subtitles are turned off.

In initial setting:

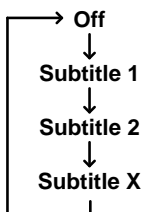

Switching angles

On DVD discs in which video images have been recorded in two or more angles, you can switch among the angles during playback.

Press the **[ANGLE]** button during playback.

- Each time you press the button, you can switch among angles.
- Depending on the disc, up to 9 angles may be recorded. For details, see the mark of the disc (9): Indicates multi-angle).
- Depending on the disc, angles may switch smoothly or switch with a momentary still image.
- Depending on the disc, switching may be completely impossible or impossible on some scenes.
- It may take time to switch among angles.
- Depending on the disc, scenes recorded in two or more angles may be played back.

Displaying the playback status

Press the [P. TIME] button during playback.

→When pressing the [P. TIME] button.

Each time you press the button, you can switch between display (ON) and non-display (OFF) of the playback status.

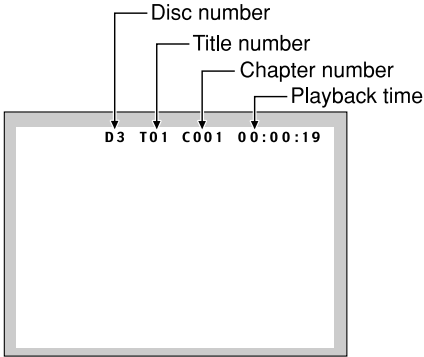

- Even when display of the playback status is OFF, you can display the playback status by operating the button.

By pressing the button for 1 second or longer while the playback status is displayed, you can switch among time displays.

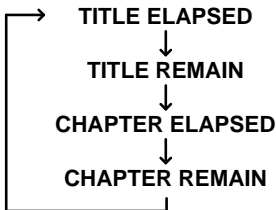
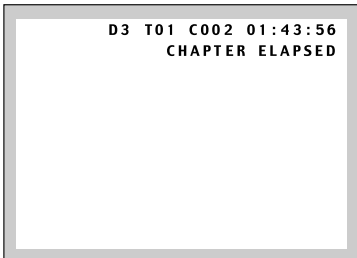

- **TITLE ELAPSED:**
Elapsed time of the title
- **TITLE REMAIN:**
Remaining time of the title
- **CHAPTER ELAPSED:**
Elapsed time of the chapter
- **CHAPTER REMAIN:**
Remaining time of the chapter

Watching a video CD

After disc selection, the play mode is automatically engaged.

- Button operation may not be allowed depending on the story of the disc.

■ After the menu screen is displayed

For V-CD discs equipped with the PBC (Play Back Control) function, the menu screen appears. After the menu screen is displayed, select an item in the following operations and play it back.

Selecting the V-CD menu (for V-CD discs with PBC)

This key does not function on some discs.

1. Press the [MENU] button during playback.

→The V-CD menu appears.

The displayed contents may differ, depending on the V-CD software.

- Example showing menu display

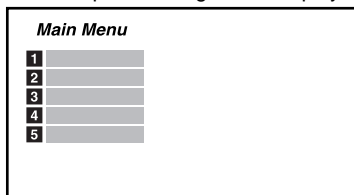

The menu screen can be switched depending on a disc being played.

2. Otherwise, select an item with the ten-key buttons on the remote control unit and press the [ENT] button to enter.

→The video images of the selected item are played back.

Stopping playback

Press the Stop [■] button during playback.

→Playback stops.

When the PBC is turned on

- When the Play/pause [▶/||] button is pressed, the disc plays from the beginning. If the unit is CeNET connected and the function is switched, the disc plays from the beginning.

When the PBC is turned off

■ To resume playback

- Press the Play/pause [▶/||] button, and playback resumes from the scene where playback is stopped.

Pausing playback

Press the Play/pause [▶/||] button during playback.

→Playback pauses.

■ To resume playback

- Press the Play/pause [▶/||] button, and playback resumes.

Slow playback

Press and hold the [SLOW] button.

→While the button is being pressed, slow playback continues at the speed 1/2 times the normal playback.

- Slow playback cannot be performed in the backward direction. In addition, audio cannot be reproduced during slow playback.

Skipping a track (searching)

Press the TRACK up [▶▶|] / TRACK down [||◀◀] button during playback.

→The track is skipped and playback starts.

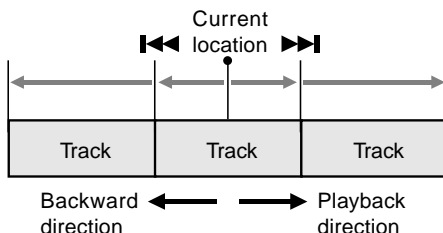

- Press the [▶▶|] button, and playback starts from the beginning of the next track.
- Press the [||◀◀] button, and playback starts from the beginning of the current track. When this button is pressed again within about 2 seconds, playback starts from the beginning of the previous track.

This operation cannot be performed on some discs with PBC.

Fast forward and fast rewind

Press and hold the Fast forward [▶▶] button or Fast rewind [◀◀] button during playback.

- Press and hold the button, and the playback speed becomes 4-time faster first and then 16-time faster 3 seconds later. Release the button, and the normal speed is restored.
- No audio is reproduced during fast forward and fast rewind operation.
- The unit may return to the menu screen when the button is pressed.

Searching with a track number

This operation allows searching with the track numbers recorded on the video CDs.

1. Press the [SEARCH MODE] button during playback.
2. Input the number of the track that you want to play back with the ten-key buttons (0 to 9).
 - To input the track number "12", press "1" of the ten-key buttons and then "2".

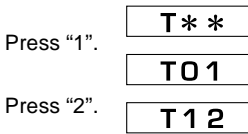

3. Press the [ENT] button.
 - Playback starts from the scene of the input track number.
 - If the input track number does not exist or searching with a track number is not allowed, the following message appears to invalidate the input.



If you are playing a disc with PBC and the PBC function is engaged, this operation may not be performed.

Changing audio output

You can change the audio output method.

Press the [AUDIO] button during playback.

- Each time you press the button, you can switch among audio output methods.

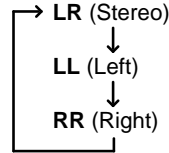

Scan playback

This operation scans and plays back all tracks on the disc, the first 10 seconds for each.

Press the [SCAN] button.

- Press the [SCAN] button again, and scan playback is turned off.

If you are playing a disc with PBC and the PBC function is engaged, this operation may not be performed.

Repeat playback

This operation plays back one track recorded on the video CD repeatedly.

Press the [RPT] button

Press the [RPT] button again, and repeat playback is turned off.

If you are playing a disc with PBC and the PBC function is engaged, this operation may not be performed.

Random playback

This operation plays back all tracks on the disc in no particular order.

Press the [RDM] button.

- Press the [RDM] button again, and random playback is turned off.

If you are playing a disc with PBC and the PBC function is engaged, this operation may not be performed.

Displaying the playback status

Press the [P.TIME] button during playback.

→When pressing the [P.TIME] button.

Each time you press the button, you can switch between display (ON) and non-display (OFF) of the playback status.

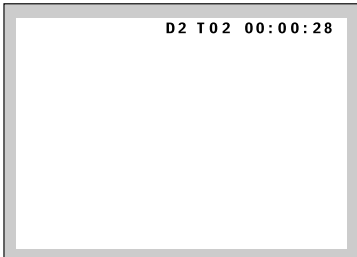

- Even when display of the playback status is OFF, you can display the playback status by operating the button.
- Depending on the playback status or disc, the following indication may appear.

By pressing the button for 1 second or longer, you can switch among time displays.

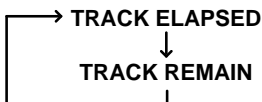
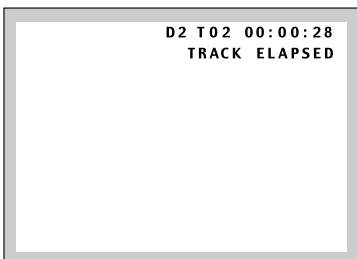

Note:

- Depending on some discs, the [P.TIME] indication may not be displayed on some scenes. Also, it may occur that the P.TIME operation does not work. When this happens, the indication "INVALID" will appear.

On/off of Play Back Control

On video CDs equipped with Play Back Control function, you can turn it on/off.

Press the [PBC] button.

→Each time you press the button, you can switch between on and off.

When the PBC is turned on or off, the disc plays from the beginning.

The factory default setting of PBC is "ON".

Playback control (PBC)

This control signal is recorded on a Video CD for version 2.0 and used to control playback. Using pre-recorded menu screens in the Video CD with PBC, you can enjoy playback of software with a simplified dialog function or software with search function. You can also enjoy a still picture at high or standard resolution.

When the PBC is turned on

The beginning of a disc is played if one of the operations such as "SET UP", "DISC SEL", "STOP" or "ACC ON/OFF" is performed.

Listening to a CD

*This unit is a CD TEXT compatible model.

This unit supports the display of the DISC TITLE, TRACK TITLE and ARTIST of the CD TEXT.

Note:

- This unit supports only CD TEXT in English. Also, some character data may not be reproduced properly on the display.

After disc selection, the play mode is automatically engaged.

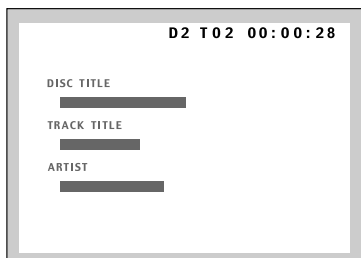

CD TEXT display

Stopping playback

Press the Stop [■] button during playback.

→ Playback stops.

■ To resume playback

- Press the Play/pause [▶/||] button, and playback resumes from the scene where playback is stopped.

Pausing playback

Press the Play/pause [▶/||] button during playback.

→ Playback pauses.

■ To resume playback

- Press the Play/pause [▶/||] button again, and playback resumes.

Skipping a track (searching)

Press the TRACK up [▶▶I] / TRACK down [I◀◀] buttons.

- Tracks are skipped, as many as the times the button is pressed, and playback starts.
- Press the [▶▶I] button, and playback starts from the beginning of the next track.
- Press the [I◀◀] button, and playback starts from the beginning of the current track. When this button is pressed again within about 2 seconds, playback starts from the beginning of the previous track.

Fast forward and fast rewind

Press and hold the Fast forward [▶▶▶] button or Fast rewind [◀◀◀] button during playback.

- Press and hold the button, and the playback speed becomes 4-time faster first and then 8-time faster 3 seconds later. Release the button, and the normal speed is restored.

Searching with a track number

This operation allows searching using the track numbers recorded on the CDs.

1. Press the [SEARCH MODE] button during playback.
2. Input the number of the track that you want to play back with the ten-key buttons (0 to 9).
 - To input the track number "12", press "1" of the ten-key buttons and then "2".

Press "1".

Press "2".

3. Press the [ENT] button.

- Playback starts from the scene of the input track number.
- If the input track number does not exist or searching with a track number is not allowed, the following message appears to invalidate the input.

Scan playback

This operation scans and plays back all tracks recorded on the disc, the first 10 seconds for each.

Press the [SCAN] button.

- Press the [SCAN] button again, and scan playback is turned off.

Listening to a CD

Repeat playback

This operation plays back tracks recorded on the CD repeatedly.

Press the [RPT] button for track repeat.

Press the [RPT] button 1 second or longer for disc repeat.

- **Track repeat:**

Plays back one track repeatedly.

- **Disc repeat:**

Plays back all tracks on the disc repeatedly.

Press the [RPT] button again, and repeat playback is turned off.

Random playback

This operation plays back all tracks on the disc in no particular order.

Press the [RDM] button.

→ Press the [RDM] button again, and random playback is turned off.

Changing the display of the playback status

By pressing the [P.TIME] button longly, you can switch among time displays.

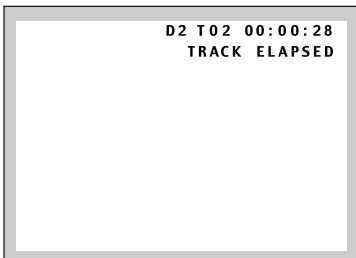

Listening to an MP3

This unit is a ID3 Tag compatible model.

This unit supports the title, artist and album display of the ID3 Tag versions 1 and 1.1.

MP3

What is MP3?

MP3 is an audio compression method and classified into audio layer 3 of MPEG standards. This audio compression method has penetrated into PC users and become a standard format.

This MP3 features the original audio data compression to about 10 percent of its initial size with a high sound quality. This means that about 10 music CDs can be recorded on a CD-R disc or CD-RW disc to allow a long listening time without having to change CDs.

Precautions when creating an MP3 disc

● File extensions

1. Always add a file extension “.MP3” or “.mp3” to an MP3 file by using single byte letters. If you add a file extension other than specified or forget to add the file extension “.MP3” or “.mp3”, the file cannot be played. In addition, if you use upper case and lower case letters (capital and small letters) mixedly for file extensions, normal play may not be possible.
2. Files without MP3 data will not play.

● Logical format (File system)

1. When writing an MP3 file on a CD-R disc or CD-RW disc, please select “ISO9660 level 1 or level 2 (without including expansion format)” as the writing software format. Normal playback may not be possible if the disc is recorded on another format.
2. The folder name and filename can be displayed as the title during MP3 play but the title must be within 31 and 27 single byte alphabetical letters and numerals for the folder name and filename, respectively (without including an extension). Entering more letters or numerals than specified may cause an incorrect display.

● Folder structure

1. A disc with a folder having more than 8 hierarchical levels will conflict with the ISO9660 and playback will be impossible.

● Number of files or folders

1. A total of 255 files and folders are allowed. (However, the maximum number of folders must be within 254.) When the number of files and folders is more than 256, playback of tracks in excess of that number is impossible.
2. Tracks are played in the order that they were recorded onto a disc. (Tracks might not always be played in the order displayed on the PC.)

- Some noise may occur depending on the type of encoder software used while recording.
- Files created using LAME (Lame Aint MP3 Encoder) may not be played properly.
- In case of a track recorded at VBR (variable bit rate), the display for the play time of the track may be slightly different from the actual play time.
Also, the recommended value of VBR ranges from 64 kbps to 320 kbps.
- Depending on the damage conditions of a file, it may occur that the file is not played and the next file is played instead.
Also, if the damage is in a severe condition, play stops showing the “DISC ERROR” display.

After disc selection, the play mode is automatically engaged.

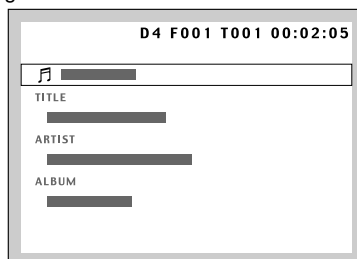

ID3 Tag display example

Note:

- If ID3 Tag information was entered with 2-byte characters, it may occur that the characters are not reproduced properly on the display.

Stopping playback

Press the Stop [■] button during playback.

→ Playback stops.

■ To resume playback

- Press the Play/pause [►/||] button, and playback resumes from the scene where playback is stopped.

Pausing playback

Press the Play/pause [▶/||] button during playback.

→ Playback pauses.

■ To resume playback

- Press the Play/pause [▶/||] button again, and playback resumes.

Skipping a track (searching)

Press the TRACK up [▶▶] / TRACK down [◀◀] buttons.

- Tracks are skipped, as many as the times the button is pressed, and playback starts.
- Press the [▶▶] button, and playback starts from the beginning of the next track.
- Press the [◀◀] button, and playback starts from the beginning of the current track. When this button is pressed again within about 2 seconds, playback starts from the beginning of the previous track.

This operation skips the track over the folder.

Fast forward and fast rewind

Press and hold the Fast forward [▶▶▶] button or Fast rewind [◀◀◀] button during playback.

- Press the button, and the playback speed becomes 4-time faster first and then 8-time faster 3 seconds later. Release the button, and the normal speed is restored.

Selecting a track on the screen

Select a desired file with the Cursor button (“▼” and “▲”) and press the [ENT] button.

→ Play starts.

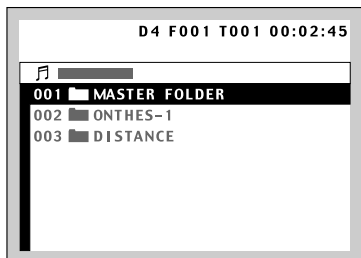

FOLDER list display

Screen selection flow

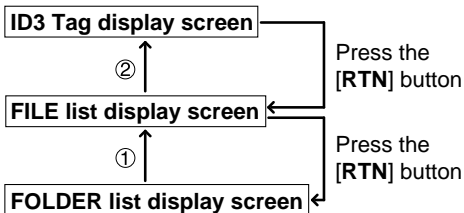

- ① Select with the Cursor button (“▲” and “▼”) and determine with the [ENT] button.
- ② In case of a file on which ID3 Tag information data have been recorded...
If any cursor button input was not made for a specified period of time after file selection, ID3 Tag screen is displayed.

Playback by selecting a folder and track (Direct select mode)

This operation allows searching using the folder and track numbers recorded on the MP3 disc.

1. Press the [SEARCH MODE] button during playback.
 - Each time you press the button, you can switch between “T000” for track number input and “F000” for folder number input.
2. Input the number for the track or folder that you want to play back with the ten-key buttons (0 to 9).
3. Press the [ENT] button.

When you select the folder number playback starts from Track 1 of the input folder number.

When you are searching for some other folder and track while a file is being played, pressing the [MENU] button will return to the file being played.

Searching a desired track (Track scan playback)

● About track scan playback

This operation plays back all tracks recorded on the disc, about 10 seconds for each.

Press the [SCAN] button.

- The monitor displays “TRACK SCN”.
- Scan playback starts from the next track.

■ To cancel track scan playback

Press the [SCAN] button again.

- The playback status indication “TRACK SCN” goes off from the monitor and the track currently being played back continues.

Searching for a desired folder (Folder scan playback)

● About folder scan playback

This operation plays back the first tracks of all folders on the MP3 disc, about 10 seconds for each.

Press the [SCAN] button for 1 second or longer.

- The monitor displays “FOLDER SCN” and folder scan playback starts.
- Scan playback starts from the first track of the next folder to the one currently being played back.

■ To cancel folder scan playback

Press the [SCAN] button again.

- The playback status indication “FOLDER SCN” goes off from the monitor and the track currently being played back continues.

Listening to one track repeatedly (Track repeat playback)

● About track repeat playback

This operation plays back the track currently being played back repeatedly.

Press the [RPT] button.

- The monitor displays “TRACK RPT” and track repeat playback starts.

■ To cancel track repeat playback

Press the [RPT] button again.

- The playback status indication “TRACK RPT” goes off from the monitor and the track currently being played back continues in normal playback.

Listening to tracks in a folder repeatedly (Folder repeat playback)

● About folder repeat playback

This operation plays back tracks in an MP3 folder repeatedly.

Press the [RPT] button for 1 second or longer.

- The monitor displays “FOLDER RPT” and folder repeat playback starts.

■ To cancel folder repeat playback

Press the [RPT] button again.

- The playback status indication “FOLDER RPT” goes off from the monitor and the track currently being played back continues in normal playback.

Listening to tracks in a random order

(Track random playback)

● About track random playback

This operation plays the tracks in the folder in a random order.

Press the [RDM] button.

- The monitor displays “TRACK RDM” and random playback starts.

■ To cancel track random playback

Press the [RDM] button again.

- The playback status indication “TRACK RDM” goes off from the monitor and the track currently being played back continues in normal playback.

Listening to tracks in a random order

(Folder random playback)

● About folder random playback

This operation plays back tracks recorded on the disc in no particular order.

Press the [RDM] button for 1 second or longer.

- The monitor displays “FOLDER RDM” and folder random playback starts.

■ To cancel folder random playback

Press the [RDM] button again.

- The playback status indication “FOLDER RDM” goes off from the monitor and the track currently being played back continues in normal playback.

Changing the display of the playback status

By pressing the [P.TIME] button for 1 second or longer, you can switch among time displays.

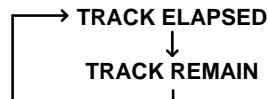
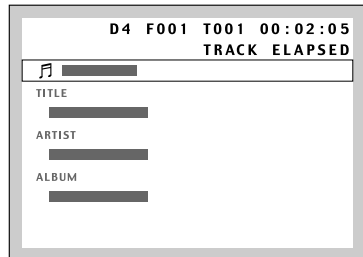

DVD changer operation on the source unit after the CeNET connection has been made

When performing this operation, set the **MODE switch to the CeNET position.**

Consult your store of purchase with regard to the CeNET connection-compatible source units to which this unit can be connected.

The operation and display available using the CeNET connection are a simplified function, and do not provide you with the full functions available on the DVD changer. If you want to use the full functions of the DVD changer, you must operate them using the remote control unit in the same manner as the DVD changer is used in the stand-alone mode. More than 2 DVD changers cannot be connected simultaneously. You must connect only one DVD changer to this unit.

To operate the DVD changer

Press the **[FNC]** (FUNC) button to select the DVD changer mode.

The operation and display of the DVD changer differ depending on types of DVD discs to be played.

The following table describes the operation and operating buttons concerning each of DVD, VCD and MP3 discs.

There are some operating buttons which do not correspond with those available on the source unit.

For CD operation, please refer to operating manual provided with the source unit.

Operating button	DVD	VCD	MP-3
[▶/II] button	Play/still	Play/still	Play/pause
[BND] button ([BAND] button)	Disc up	Disc up	Disc up
[DIRECT] button (P.ch1-6)	Disc select	Disc select	Disc select
[◀◀], [▶▶] button	Chapter up/down When Pressed and held for 1 second or longer; Fast-forward/Fast-rewind	Track up/down When Pressed and held for 1 second or longer; Fast-forward/Fast-rewind	Track up/down When Pressed and held for 1 second or longer; Fast-forward/Fast-rewind
[RPT] button ([RP] button)	Chapter repeat When Pressed and held for 1 second or longer; title repeat.	Track repeat When Pressed and held (PBC turned off)	Track repeat When Pressed and held for 1 second or longer; Folder repeat.
[SCN] button ([SC] button)	Chapter scan.	Track scan. (PBC turned off)	Track scan. When Pressed and held for 1 second or longer; Folder scan.
[RDM] button ([RD] button)	_____	Track random. (PBC turned off)	Track random. When Pressed and held for 1 second or longer; Folder random.
After pressing the [▶/II] button, press the [▶▶] button for 1 second or longer. press the [◀◀] button for 1 second or longer.	Slow play Reverse slow play	Slow play	_____

Changing Initial Settings such as Menu Language, etc.

Menu settings described in this section are displayed on the monitor and can be selected by operating the remote control unit.

If the set language has not been recorded on the disc, the language specified on the disc is used for display.

Selecting the monitor menu

1. Press the [SET UP] button to display the main menu.
2. Select **GENERAL SETUP** or **PREFERENCES** with the “▲” or “▼” button and press the [ENT] to enter.
3. Press the “▲” or “▼” button to select the left menu item.
4. Press the “▶” button to go to the option list.
5. Press the “◀” button to go to the left menu item.
6. Press the [RTN] button to display the main menu.
7. Press the [SET UP] button to return to the original mode from the set-up mode engaged.

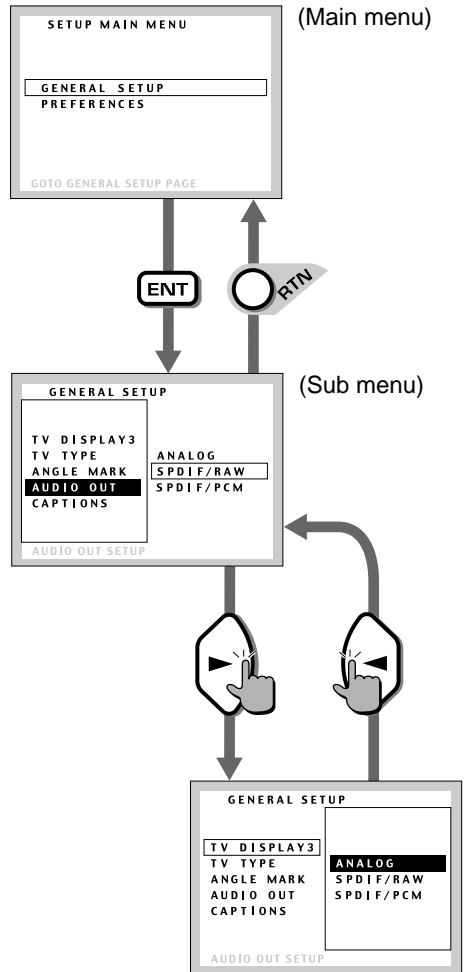

Setting up the screen size

Set up the screen size according to the TV monitor to which the unit is connected.

- Following the steps 1 to 4 in “**Selecting the monitor menu**”, select “**TV DISPLAY**” from “**GENERAL SETUP**”.

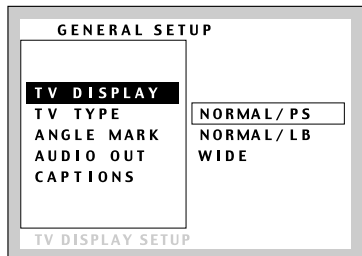

- Press the “▲” or “▼” button to select a screen size.

→The color of the selected item changes.

- When watching through a conventional TV monitor (4:3)
 - NORMAL/PS** : The leftmost and rightmost areas of the screen are cut off.

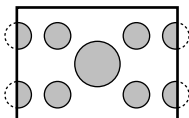

This function allows displaying the important part of image fully on the screen. In some cases, image is displayed while being panned (scrolled).

- NORMAL/LB** : A black zone is created in the top and bottom areas of the screen.

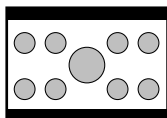

This method displays Cinema Scope and Vista Vision images without cutting them off by creating a black zone on the top and bottom gaps.

- When watching through a wide TV monitor (16:9)

- WIDE**:

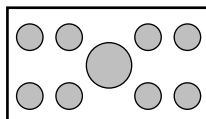

- Press the [ENT] button to enter.

The factory default setting is NORMAL/PS.

Setting up the TV type

Set the TV type to NTSC, PAL, MULTI.

- Following the steps 1 to 4 in “**Selecting the monitor menu**”, select “**TV TYPE**” from “**GENERAL SETUP**”.

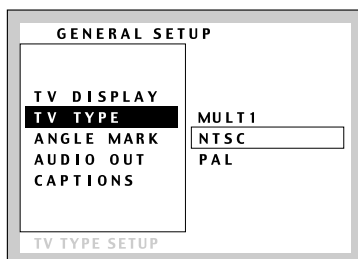

- Press the “▲” or “▼” button to select MULTI, NTSC, or PAL.

- Press the [ENT] button.

The factory default setting is NTSC.

* This setting can be changed with the [NTSC/PAL] button on the remote control unit. For a detailed information, see pages on which the sections entitled “**4. REMOTE CONTROL**” and “**5. COMPONENTS AND FUNCTIONS**” are found.

Setting up the angle mark display

You can set up so that the angle mark appears on scenes where the angles can be switched.

1. Following the steps 1 to 4 in “**Selecting the monitor menu**”, select “**ANGLE MARK**” from “**GENERAL SETUP**”.

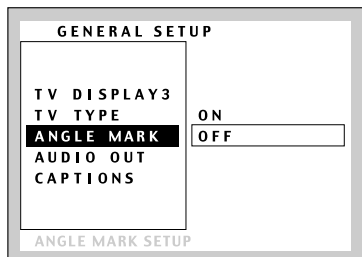

2. Press the “▲” or “▼” button to select ON or OFF.
3. Press the [ENT] button.
The factory default setting is OFF.

Setting up the output mode for audio signals

1. Following the steps 1 to 4 in “**Selecting the monitor menu**”, select “**AUDIO OUT**” from “**GENERAL SETUP**”.

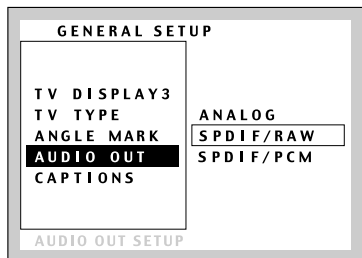

2. Press the “▲” or “▼” button to select ANALOG, SPDIF/RAW, or SPDIF/PCM.

● ANALOG:

Outputs analog audio signals through RCA connection.

● SPDIF/RAW:

Outputs 5.1ch digital signals through optical connection.

PCM audio signals are output downsampling the signal from 96 KHz to the lower sampling rate, 48 KHz.

● SPDIF/PCM:

Outputs 2ch digital signals through optical connection.

PCM audio signals are output downsampling the signal from 96 KHz to the lower sampling rate, 48 KHz.

3. Press the [ENT] button.

The factory default setting is ANALOG.

Setting up the subtitle display

1. Following the steps 1 to 4 in “**Selecting the monitor menu**”, select “**CAPTIONS**” from “**GENERAL SETUP**”.

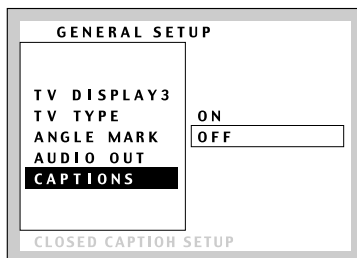

2. Press the “▲” or “▼” button to select ON or OFF.

3. Press the [ENT] button.

The factory default setting is OFF.

Changing Initial Settings such as Menu Language, etc.

Setting up the audio language

1. Following the steps 1 to 4 in "Selecting the monitor menu", select "AUDIO" from "PREFERENCES".
2. Press the "▲" or "▼" button to select a language to be used.

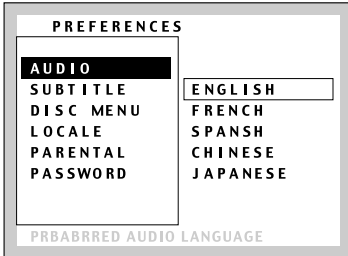

Setting up the subtitle language.

1. Following the steps 1 to 4 in "Selecting the monitor menu", select "SUBTITLE" from "PREFERENCES".
2. Press the "▲" or "▼" button to select a language to be used.

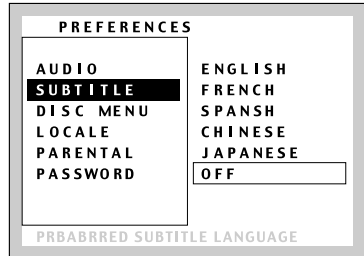

Languages SELECT in the order

ENGLISH
↕
FRENCH
↕
SPANISH
↕
CHINESE
↕
JAPANESE

3. Press the [ENT] button.
The factory default setting is ENGLISH.

Languages SELECT in the order

ENGLISH
↕
FRENCH
↕
SPANISH
↕
CHINESE
↕
JAPANESE
↕
OFF

3. Press the [ENT] button.
The factory default setting is OFF.

Setting up the disc menu language.

1. Following the steps 1 to 4 in “Selecting the monitor menu”, select “DISC MENU” from “PREFERENCES”.
2. Press the “▲” or “▼” button to select a language to be used.

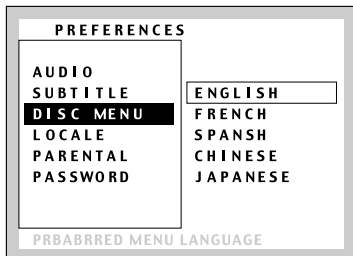

Languages SELECT in the order

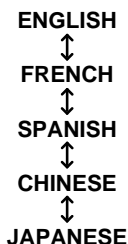

3. Press the [ENT] button.
The factory default setting is ENGLISH.

Setting up the country code

Set up the country number for setting up of the parental level.

1. Following the steps 1 to 4 in “Selecting the monitor menu”, select “LOCALE” from “PREFERENCES”.

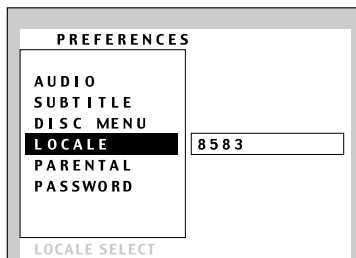

2. Press the [ENT] button to display the input screen.
 3. Press the ten-key buttons to input a 4-digit country number.
 4. Press the [ENT] button.
- The default setting is 8583 (US).

Country code list

Country	Input code
CANADA	6765
UNITED STATES	8583
AMERICAN SAMOA	6583
BERMUDA	6677
PUERTO RICO	8082
ST. PIERRE AND MIQUELON	8077
VIRGIN ISLANDS (U.S)	8673

Setting up the parental level

You can change the level of parental lock (audio-visual restriction).

This function allows cutting scenes that are unfavorable for children or replacing them automatically with other scenes prepared in advance. For example, by replacing scenes of radical violence or portrayals of sex with safe scenes, you can make a trouble-free story as if it were so from the beginning.

1. Following the steps 1 to 4 in “**Selecting the monitor menu**”, select “**PARENTAL**” from “**PREFERENCES**”.

2. Press the “▲” or “▼” button to select a parental level.

You can select from 1 to 8 or NO PARENTAL.

The factory default setting is level 8.

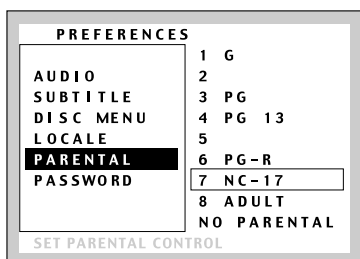

3. Press the [ENT] button to display the PASSWORD VERIFY screen.

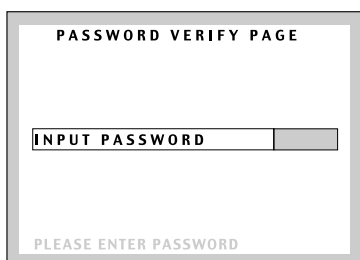

4. Press the ten-key buttons to input a 4-digit password.

*Factory default setting is [0000].

Setting up the password for setting up of the parental level

1. Following the steps 1 to 4 in “**Selecting the monitor menu**”, select “**PASSWORD**” from “**PREFERENCES**”.

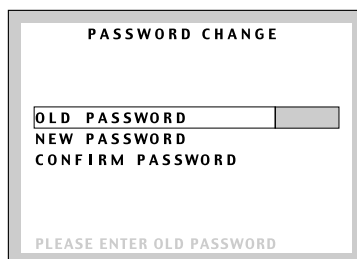
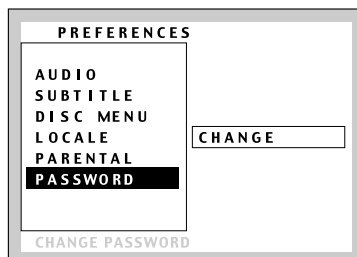

2. Press the [ENT] button to display the PASSWORD CHANGE screen.

3. Input a old password.

4. Input a new password.

5. Input a confirm password.

It is recommended that you take down a memo about the password and keep it safely to avoid forgetting it.

Note:

When a disc with view limited is played

When a disc with view limited is played, the input screen requiring you to input the password may appear. When this happens, enter the correct password, otherwise play does not start.

9. IN CASE OF DIFFICULTY

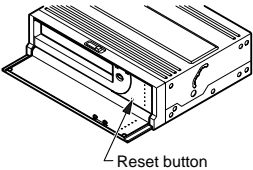
Problem	Cause	Measure
Power does not turn on. (No sound is produced.)	Fuse is blown.	Replace with a fuse 3A of the same amperage. If the fuse blows again, consult your store of purchase.
	Incorrect wiring.	Consult your store of purchase.
	The setting of the CeNET/STAND ALONE select switch is not correct.	Set the switch to the correct position.
	The microprocessor has malfunctioned due to noise, etc.	Press the reset button with a thin rod. Note; When the reset button is pressed, turn off the ACC power.
		
Nothing happens when buttons are pressed.	The microprocessor has malfunctioned due to noise, etc.	Press the reset button with a thin rod. Note; When the reset button is pressed, turn off the ACC power.
The remote control unit does not work.	The batteries are dead.	Replace them with new ones.
	The remote control receiver connector is not deeply inserted.	Insert the connector deeply.
Sound is bad directly after power is turned on.	Water droplets may form on the internal lens when the car is parked in a humid place.	Let dry for about 1 hour with the power on.
Magazine cannot be loaded.	Magazine inserted wrongly.	Insert correctly.
	A magazine is already in the player.	Eject the magazine and insert the other.
	Distorted magazine.	Buy New Magazine CAA-397.
"No Disc" sign appears when searching for discs.	Disc inserted upside-down.	Read the section on "Inserting The Disc" carefully and reinsert the Disc correctly.
	Moisture or dirt on disc.	Wipe disc free of moisture and dirt.
Sound skipped.	Lock screw left attached.	Remove the lock screw.

Problem	Cause	Measure
Noise, skipping	The installation selector levers are set to different positions on both sides.	Set the installation selector levers to the same position on both sides.
	The unit installation direction and the installation selector lever positions do not match.	Set the unit installation direction and the installation selector lever positions to match each other. When installed at an angle, change the installation selector lever to a position (H, 45°, V) not prone to noise or sound loss.
	Disc bent or badly damaged.	Compare with another disc. If bad, discard the damaged disc.
	Disc is very dirty.	Clean the disc.
Mechanism does not function.	Mechanical error.	<ol style="list-style-type: none"> 1. Reading the section "INSTALLATION" of Installation Manual thoroughly, check the three angle of installation selector levers are properly set. If not, set them at the proper position for the angle of installation. 2. Check whether The magazine can be ejected by pressing the magazine eject button, then insert a new magazine.

If the same phenomenon still occurs after checking the above, or it is impossible to remove the magazine, please consult your local dealer.

10. ERROR DISPLAYS

If an error occurs, one of the following displays is displayed.

Take the measures described below to eliminate the problem.

Error	Cause	Measure
MECHA ERROR	The failure of the changer itself considered.	Consult your store of your purchase or the Clarion repair window.
DISC ERROR (ERROR6)	<ol style="list-style-type: none"> 1. A DVD/CD cannot be played due to scratches, etc. 2. A DVD/CD cannot be played due to the defective pick-up part. 3. The disc is placed up side down. 	Replace with a non-scratched, non-warped-disc. Replace the disc with face up.
WRONG REGION	Disc region code incorrect.	Use a disc with the correct region code.
PARENTAL VIOLATION	The view is limited.	Release the view limitation or change the parental level. (See the subsection "Setting up the parental level".

If an error display other than the ones described above appears, press the reset button. When the reset button is pressed, frequencies of TV/radio stations, titles, etc. stored in the memory are cleared.

If the problem persists, turn off the power and consult your store of purchase.

11. SPECIFICATIONS

DVD player section

System: Digital Versatile Disc System with CDDA Capable

Usable Discs: DVD Video Disc, Compact Disc
Frequency Response: 20 Hz to 20 kHz (± 1 dB)
Signal to Noise Ratio: 90 dB
Distortion: 0.02%
Channel Separation: 80 dB
Analog audio output 1.8 Vrms

General

Source unit

Power Supply Voltage:
14.4 V DC (10.8 to 15.6 V allowable)
Ground: Negative
Current Consumption : Less than 1.5 A
Weight: 3.5lb. (2.2 kg)
Dimensions:
9-1/16" Width X 3-1/4" Hight X 7-3/16" Depth
(230 mm Width X 83 mm Hight 183 mm Depth)

Remote control unit

Weight: 1oz. (130 g) (including battery)
Dimensions:
2-1/8" Width X 1-1/16" Hight X 6-1/8" Depth
(54 mm Width X 27.2 mm Hight 155 mm Depth)

Remote control receiver section

External dimensions:
7/8" Width X 1-5/8" Hight X 1/2" Depth
(22 mm Width X 41.5 mm Hight 13.3 mm Depth)
Mass: 33 g

Note:

- Specifications and design are subject to change without notice for further improvement.

List of accessories

VCZ625	1
Owner's manual	1
Installation instructions	1
Warranty	1
Ce-NET cable (5 m)	1
Power cord (5 m)	1
Parts bag	
• Installation nut (M5)	4
• Installation bolt (M5 x 8)	4
• Clamping band	2
Bracket with bolt	2
Bracket for installing the main unit	
(for vertical installation)	2
(for horizontal installation)	2
Batteries for remote control unit (type AA)	2
Remote control unit	1
Double sided tape for securing brackets	2
Magazine (CAA-397)	1
Remote control receiver	1
RCA pin cord (audio), 5 m	1
RCA pin cord (video), 5 m	1
Ferrite core	1

