

COBY®

TF-DVD450

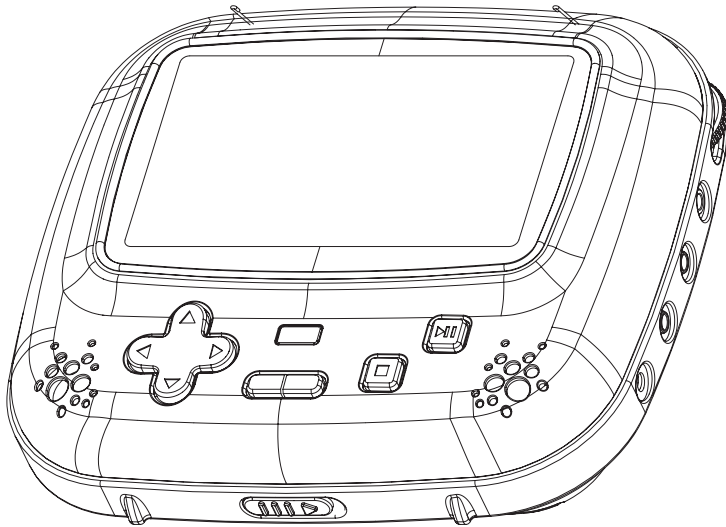

4.5" Widescreen TFT LCD Portable DVD/CD/MP3 Player



Instruction Manual

Please read this manual carefully before operation.

PRECAUTIONS

	CAUTION RISK OF ELECTRIC SHOCK DO NOT OPEN	
CAUTION: TO REDUCE THE RISK OF FIRE AND ELECTRIC SHOCK, DO NOT REMOVE THE COVER (OR BACK) OF THE UNIT. REFER SERVICING ONLY TO QUALIFIED SERVICE PERSONNEL.		

For Customer Use:

Enter below the serial number that is located on the bottom of the unit. Retain this information for future reference.

Model No. TF-DVD450

Serial No. _____



The lightning flash with arrowhead symbol within an equilateral triangle is intended to alert the user to the presence of uninsulated "dangerous voltage" within the product's enclosure that may be of sufficient magnitude to constitute a risk of electric shock.



The exclamation point within an equilateral triangle is intended to alert the user to the presence of important operation and servicing instructions in the literature accompanying the appliance.

WARNING:

To prevent fire or shock hazard, do not expose this device to rain or moisture. Dangerous high voltage is present inside the enclosure. Do not open the cabinet.

CAUTION:

This Digital Video Disc player employs a laser system. To prevent direct exposure to the laser beam, do not try to open the enclosure or defeat the safety interlocks. When open and the interlocks are defeated, visible laser radiation is present.

Use of controls, adjustments, or performance of procedures other than those specified herein may result in hazardous radiation exposure. **DO NOT STARE INTO THE BEAM.**

FCC Notice:

This equipment has been tested and found to comply with the limits for a Class B digital device pursuant with the FCC Rules, Part 15. These limits are designed to provide reasonable protection against harmful interference in a residential installation. This equipment generates, uses, and can radiate radio frequency energy, and if not installed and used in accordance with the instructions may cause harmful interference to radio communication.

WARNING:

Handling the cords on this product will expose you to lead, a chemical known to the State of California to cause cancer, and birth defects or other reproductive harm. **Wash hands after handling.**

CAUTION:

To prevent electric shock, match wide blade of plug to wide slot of outlet and fully insert.

NOTICE:

This product incorporates copyright protection technology that is protected by U.S. patents and other intellectual property rights. Use of this copyright protection technology must be authorized by Macrovision, and is intended for home and other limited viewing uses only unless otherwise authorized by Macrovision. Reverse engineering or disassembly is prohibited.



For recycling or disposal information about this product, please contact your local authorities or the Electronics Industries Alliance: www.eiae.org.

IMPORTANT SAFETY INSTRUCTIONS

1. Read these instructions carefully. Keep these instructions for future reference.
2. Heed all warnings and follow all instructions.
3. Do not expose to water or moisture.
4. Clean only with a dry cloth.
5. Keep objects away from ventilation openings. Do not block ventilation openings at any time.
6. Do not install near any apparatus that produces heat such as stoves, radiators, amplifiers, etc.
7. Do not force the power plug into a wall outlet. If the plug provided does not fit into your outlet, consult an electrician for replacement of the obsolete outlet. (A polarized plug has two blades where one is wider than the other; the wide blade is provided for your safety.)
8. Do not place heavy objects on the power cord. Protect the cord from being walked on, pinched by objects, or torn and exposed to liquids (especially at plugs, convenience receptacles, and the point at which they exit from the device).
9. Use only with attachments/accessories specified by the manufacturer. Use of attachments/accessories not recommended by the product manufacturer may be hazardous.
10. Unplug the device during lightning storms. Unplug the device and remove any batteries when the device will be unused for long periods of time.
11. Do not use this device near water. Do not place objects filled with liquids (e.g., vases) on the device. Never spill liquid of any kind on the device.
12. Never push objects of any kind into this device through openings as they may touch dangerous voltage points or short out parts that could result in a fire or electric shock.
13. Do not use headphones/earphones while cycling, driving, or operating a motorized vehicle.
14. Do not use headphones/earphones at high volume.
15. Do not drop or otherwise subject the device to impact.
16. Do not open or attempt to repair this device. Refer all repairs to authorized service personnel.
17. When replacements parts are required, be sure the service technician has used replacement parts specified by the manufacturer or that have the same characteristics as the original part. Unauthorized substitutions may result in fire, electric shock, or other hazards.
18. Upon completion of any service or repairs to this device, ask the service technician to perform safety checks to determine that the device is in proper operating condition.

Note:

The main plug is used to disconnect the device. It should remain within reach and should not be obstructed during intended use.

The rating label is located on the bottom enclosure of the device.

TABLE OF CONTENTS

PRECAUTIONS	2
IMPORTANT SAFETY INSTRUCTIONS	3
TABLE OF CONTENTS	4
ABOUT OPTICAL DISCS	6
Disc Requirements	6
Disc Care and Maintenance	6
Handling a Disc	6
Cleaning a Disc	6
PACKAGE CONTENTS	7
LOCATION OF CONTROLS	8
Main Unit	8
Left View	8
Front View	8
Right View	8
Remote Control	9
CONNECTIONS	10
Standard AV Connection to a TV	10
Optical Audio (5.1-Channel) Connection	11
Headphone Connection	11
GETTING STARTED	12
Remote Control	12
Power Supply	12
Using the AC Adapter	12
Using the Battery Pack (DC)	12
Power Management	14
LCD On/Off Button	14
Using the Integrated Stand	14
BASIC OPERATIONS	15
Basic Playback	15
Play/Pause/Stop	15
Next/Previous (Skip)	15
Forward/Reverse (Scan)	15
Slow	15
Menu Navigation	16
Numeric Keypad	16
Adjusting the Volume	16
Disc Error Messages	16



TABLE OF CONTENTS

DISC FUNCTIONS	17
LCD Mode	17
Setup	17
Display	17
Clear	17
Menu / Title	17
Search	18
DVD Chapter/Title Search:	18
DVD Time Search (within a specified title):	18
CD Time Search:	18
Repeat Mode.....	18
Repeat A-B Mode	19
Multi-Angle/Subtitle/Audio	19
Zoom	19
Program	19
DVD Program Mode.....	19
CD Program Mode.....	20
MP3 Program Mode.....	20
SETUP	21
Language Setup.....	21
Screen Setup	21
Audio Setup.....	22
Custom Setup	22
TROUBLESHOOTING	23
SPECIFICATIONS.....	25

ABOUT OPTICAL DISCS

Disc Requirements

This DVD player supports playback of the following discs.

Type	Disc Mark	Content Type	Disc Size	Max. Playback Time
DVD-Video Discs		Audio + Video (moving picture)	12 cm	133 min (SS-SL)
				242 min (SS-DL)
				266 min (DS-SL)
				484 min (DS-DL)
Audio Compact Discs (CDs)		Audio	12 cm	74 min
MP3 CDs	 (CD-R, CD-RW)	Audio	12 cm	~14 hours
JPEG CDs	--	Still Picture	12 cm	--

This unit can play back CD-R and CD-RW discs that contain audio titles, MP3 files, or JPEG picture files. Discs not listed above are not supported by this unit (e.g., PC CD-ROM, CD-Extra, CD-G, CD-I, etc.)

Disc Care and Maintenance

Optical discs (DVDs, CDs) contain high-density compressed data and need proper handling.

Handling a Disc

- Hold a DVD/CD by its edges. Avoid touching the recorded side of the disc. To remove a DVD/CD from its storage case, press down on the center retention mechanism of the case and lift the disc out.
- Do not subject discs to prolonged exposure to direct sunlight, high humidity, or high temperatures.
- Do not bend or press discs.
- To reduce the risk of scratches, always put discs back in their case after use. Store discs vertically in a cabinet.
- Do not place stickers or labels on either side of a disc.



Cleaning a Disc

Use a dry, soft cloth to wipe off any fingerprints and dusts from the playing surface of the disc. Wipe in a straight line radially from the center to the outside edge of the disc. Small dust particles and light stains will not affect playback quality.

- Never use chemicals such as record sprays, anti-static sprays, benzene, or thinners to clean a disc. Doing so will damage the surface of the disc permanently.

PACKAGE CONTENTS

Please make sure that the following items are included in the package with your DVD player. Should any of these items be missing, please contact your local dealer.

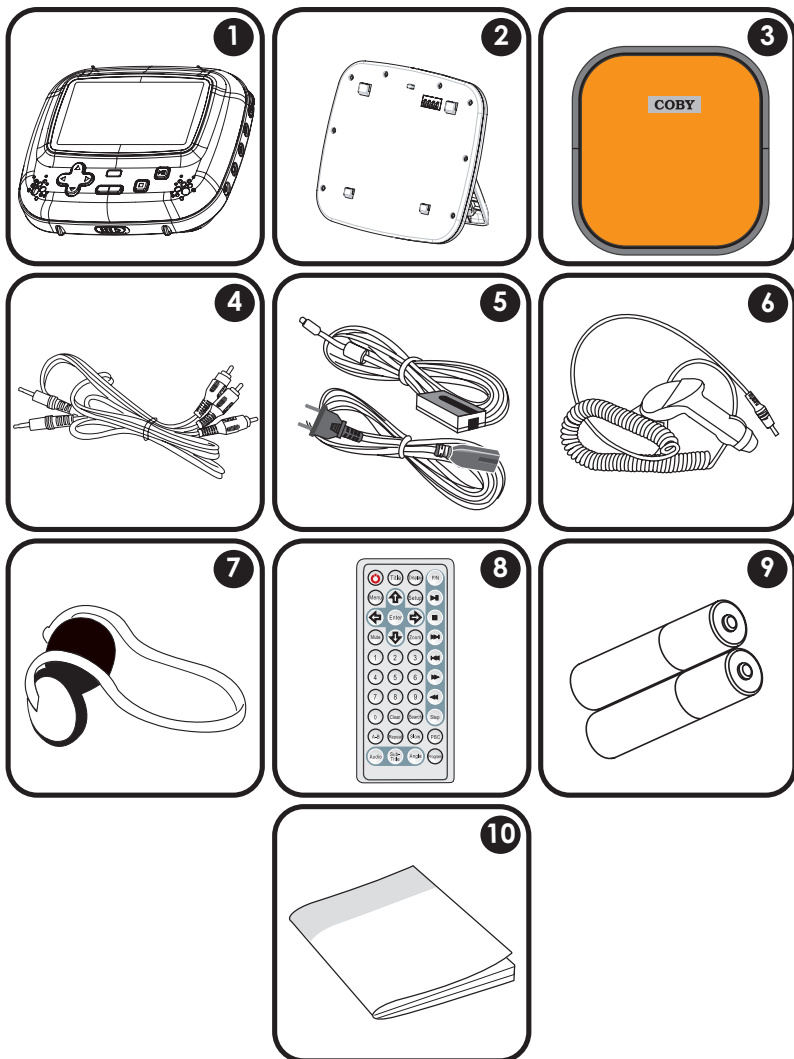

- | | | |
|------------------|----------------------|------------------------|
| 1. TF-DVD450 | 5. AC Adapter + Cord | 9. 2 x "AAA" Batteries |
| 2. Battery Pack | 6. DC Car Adapter | 10. Instruction Manual |
| 3. Carrying Case | 7. Headphones | |
| 4. AV Cable | 8. Remote Control | |

LOCATION OF CONTROLS

Main Unit

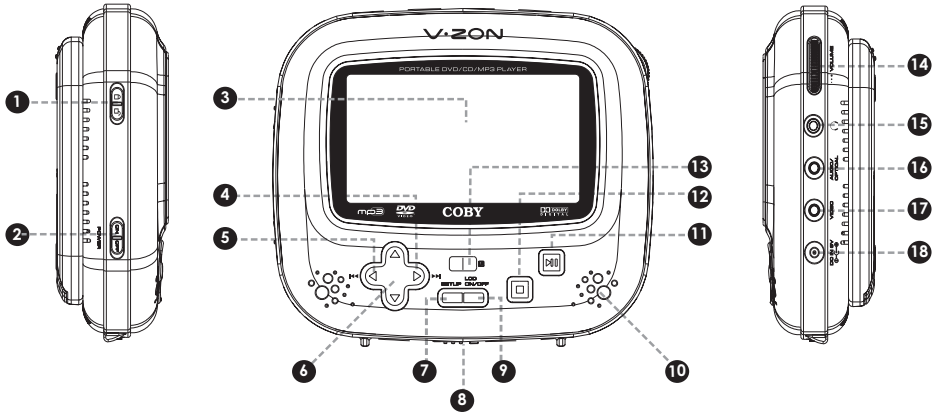

Left View

1. Hold Switch (Lock/Unlock)
2. Power Switch (On/Off)

Front View

3. LCD Display
4. Next/Forward
5. Previous/Reverse
6. Navigation Keypad (Up/Down/Left/Right)
7. Setup
8. Disc Compartment Latch
9. LCD On/Off
10. Stereo Speaker (Right)
11. Play/Pause
12. Stop
13. Remote Sensor

Right View

14. Volume Control Dial
15. Headphone Jack
16. 3.5 mm Stereo Audio Out Jack / Optical Audio Out Jack
17. Composite Video Out Jack
18. DC 9V Power In Jack

Note:

The Battery Charge Indicator lights red while the battery is charging, and green when the battery has been fully charged..

LOCATION OF CONTROLS

Remote Control

The keys on the remote control that are also on the main unit control the same functions.

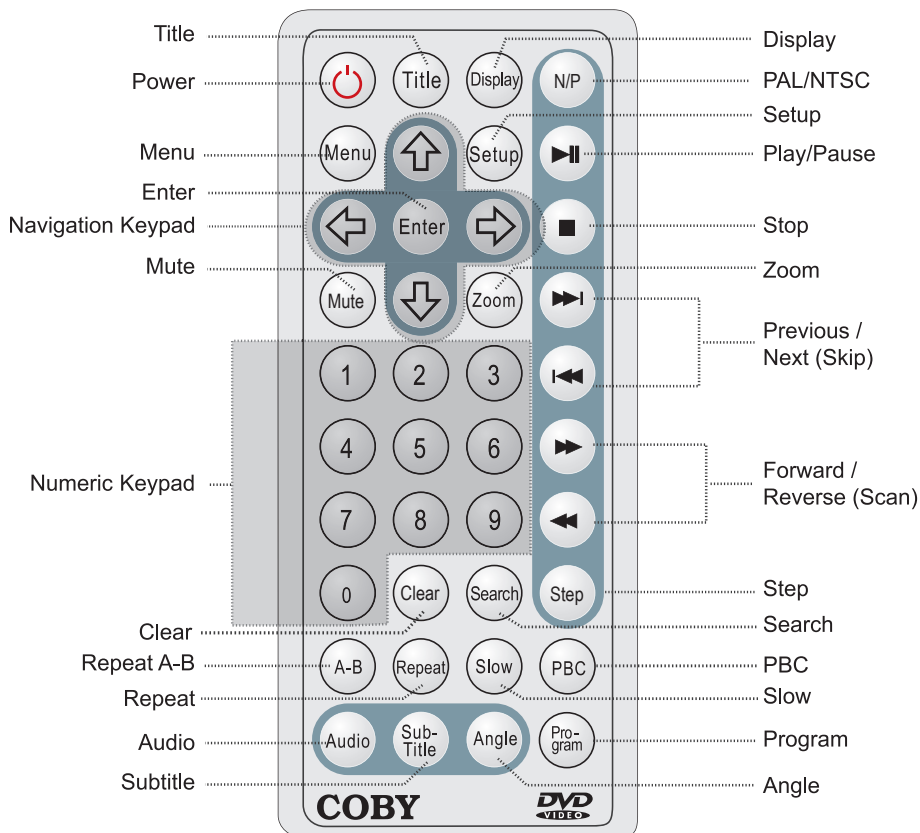

CONNECTIONS

Standard AV Connection to a TV

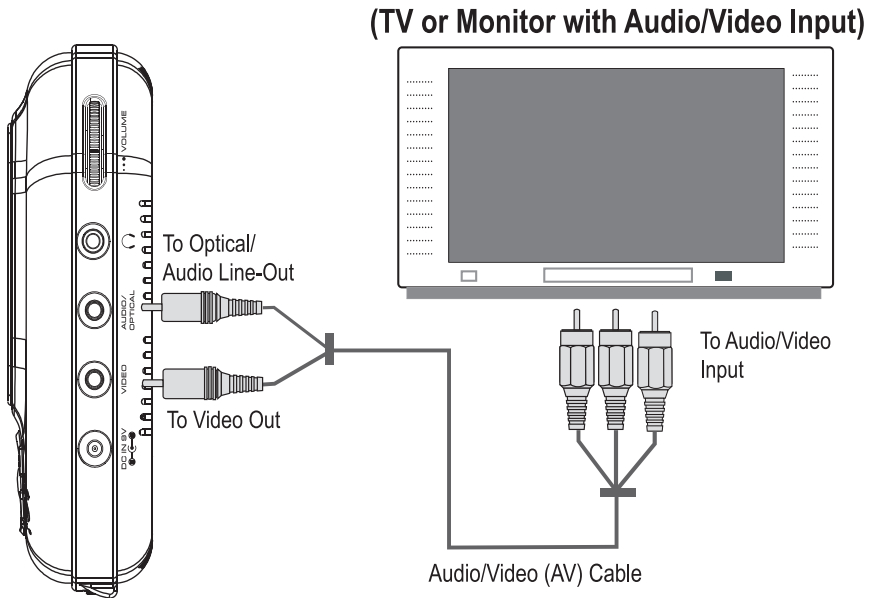

NOTE:

- Refer to your TV's instruction manual for more information on setting it to the proper AV mode.
- Be sure to turn off and unplug your player and TV before making these connections.

CONNECTIONS

Optical Audio (5.1-Channel) Connection

Your player can output 5.1-channel surround sound audio through the Optical/Audio jack. You will need a Dolby Pro Logic Surround amplifier and an optical cable to use this feature.

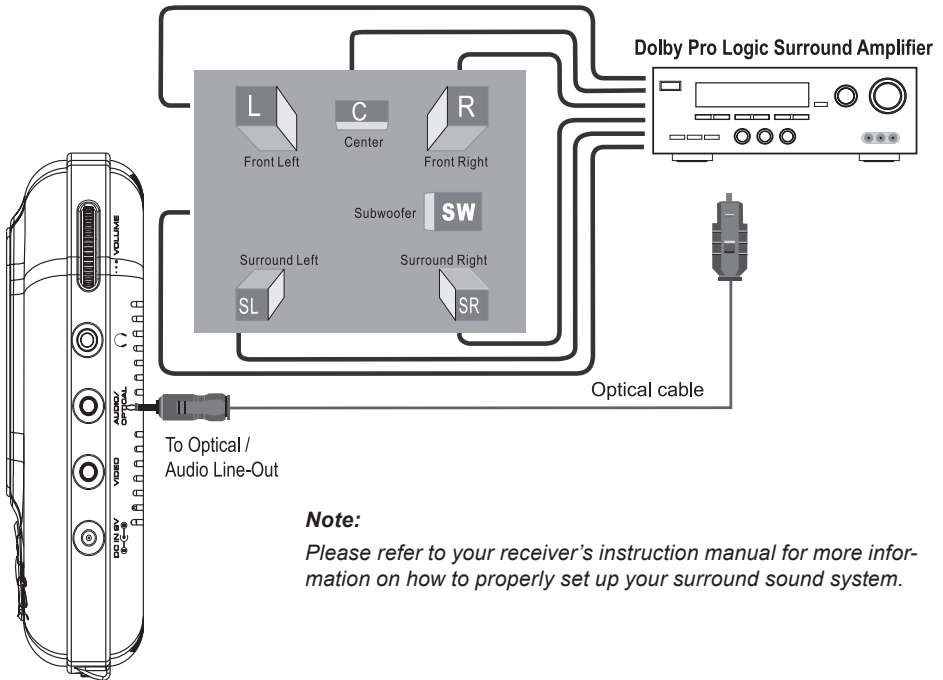

Note:

Please refer to your receiver's instruction manual for more information on how to properly set up your surround sound system.

Headphone Connection

Connect headphones to the headphone jacks for private listening.

- Lower the volume level before connecting headphones, then gradually increase the volume for comfortable listening.
- Hearing experts advise against the constant use of personal stereos played at high volume.
- Constant high-volume use can lead to hearing loss. If you experience ringing in your ears or hearing loss, discontinue use immediately and seek medical advice.

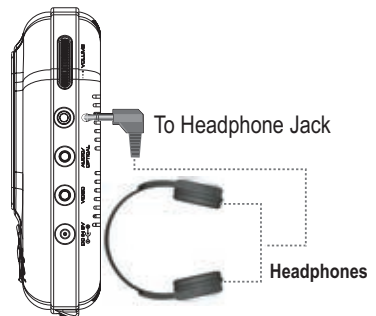

GETTING STARTED

Remote Control

- Refer to the diagram. Remove the battery compartment cover located on the rear of the remote control. Insert batteries, making sure to match their polarities (+/-) to the markings on the inside of the compartment. Replace the cover.
- To use the remote, point it at the remote sensor of the player. Operate the remote within 15 feet of the sensor and at an angle of +/- 60 degrees.
- Batteries in the remote will last for approximately 1 year. Replace the batteries if the remote control does not work. Do not mix old with new batteries, or different types of batteries.
- Remove the batteries from the remote if it will not be used for a long period of time.

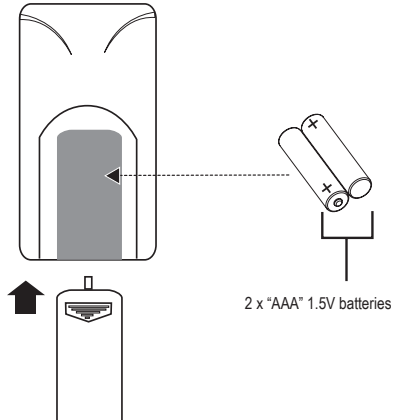

WARNING

- The battery used in this device may present a fire or chemical burn if mistreated. Do not recharge, disassemble, incinerate, or heat the battery (~212°F).
- Keep batteries away from children.

Power Supply

Using the AC Adapter

This AC adapter should be used with 100-240V 50/60Hz AC wall outlets.

- DC Out: 9V
- DC Current: 2.0A max.

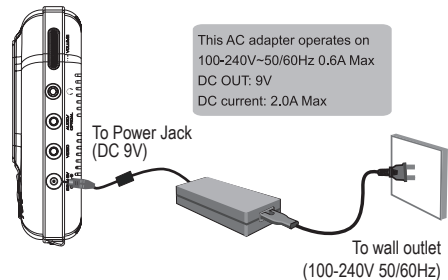

Caution:

- *Do not connect the power plug to a power outlet other than that which is indicated here and on the label as this may result in the risk of fire or electric shock.*
- *Do not handle the power plug with wet hands. Doing so may cause electric shock.*
- *Only use AC adapters of the type specified here. Failure to do so may cause a fire or damage the player.*

Using the Battery Pack (DC)

The rechargeable battery pack can be used for approximately 300 charge-cycles without any noticeable change in performance.

Important: The battery should be charged fully (minimum 4 hours) before its initial use to ensure optimum lifetime performance.

GETTING STARTED

To install the battery pack:

1. Match and insert the Retention Clips on the battery pack to the Retention Slots on the bottom of the player.
2. Press and slide the battery pack up and into place (the retention clips will click).

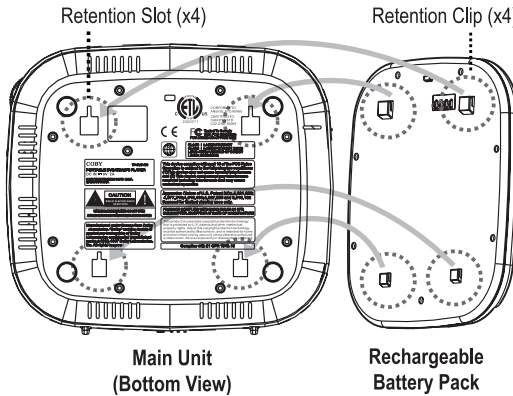

3. To release the battery, press the "OPEN" battery release button and slide the battery pack down and out.

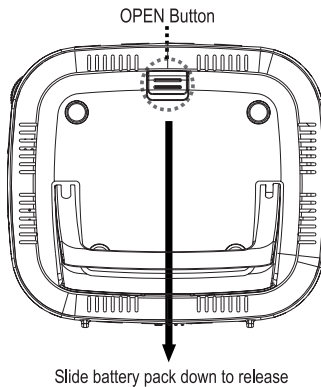

To charge the battery pack:

1. Install the battery in the manner described above.
2. Connect the player's DC 9V Power In jack to an AC power source with the AC/DC adapter as described previously. (The Battery Charge indicator will light red while it is charging; it will light green when the battery is fully charged.)

When the battery charge level is low, the unit will enter *STANDBY* mode automatically.

It is important to charge the battery fully (minimum 4 hours) before it's initial use.

GETTING STARTED

Power Management

If the player will not be in use for a long period of time, set the Power Switch to the OFF position, remove the battery, and unplug the player.

LCD On/Off Button

When you are listening to a CD or MP3-CD and do not need to use the LCD display, you can extend the player's battery-life significantly by turning off the LCD screen.

- Press LCD ON/OFF to turn the screen off. Press the button again to turn the screen back on.

Using the Integrated Stand

There is a Stand built into the back of the battery pack. You can use the stand to position the player in an upright position for easy tabletop/desktop viewing.

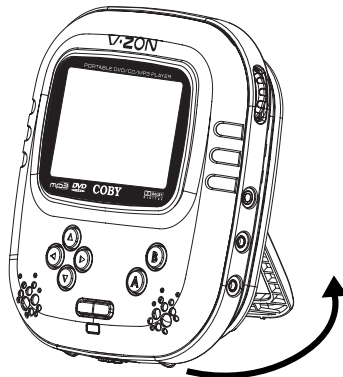







Lift stand up and out of its groove

BASIC OPERATIONS



Basic Playback

1. Turn the player on .
Set the Power Switch to the ON position to turn the player on.
2. Load a disc.
Slide the Disc Compartment Latch to the right to open the compartment lid. Insert a disc with the label-side up. Close the lid by hand (the lid will click into place).
 - If a single-sided disc is inserted upside-down, the player will display "NO DISC" or "BAD DISC".
3. Start playback.
Press PLAY to start playback (some discs may start playing automatically).

Play/Pause/Stop





- Press  to play the disc for the first time.
- Press  during playback to pause. Press  again to resume playback.
- Press  during playback to stop the disc ("Pre-Stop"). Press  to resume playback at the time-point at which the disc was stopped.
- Press  when the disc is "Pre-Stopped" to stop playback completely. (When  is pressed, the disc will start playing from the beginning.)

Next/Previous (Skip)

- Press  to skip forward one track (DVD, CD, MP3, etc).
- Press  to skip back one track (DVD, CD, MP3, etc).



Forward/Reverse (Scan)

Normal → x2 → x4 → x8 → x16 → x32

- Press  to scan forward through the disc. Each successive press of  will change the rate of forward scanning.
- Press  to scan through the disc in reverse. Each successive press of  will change the rate of reverse scanning.

Slow

Normal → x1/2 → x1/4 → x1/8 → x1/16 → x1/32

- Press SLOW for slow-motion playback. Each successive press of SLOW will change the rate of slow-motion playback. Press  to resume normal playback.
- Press STEP frame-by-frame playback. Each successive press of STEP will advance the video one frame. Press  to resume normal playback.

Note:

Audio will be muted during fast-forward, fast-reverse, and slow-motion playback.

BASIC OPERATIONS

Menu Navigation

To navigate DVD disc menus or the player's setup menus:

- Press the NAVIGATION keypads to select a desired feature or option in the menu.
- Press ENTER to confirm a selection in the menu.
 - For some menu options, you may be able to use the numeric keypad to input data.
- Press  to cancel an entry.

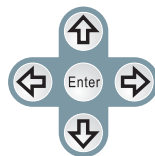

Numeric Keypad

- Use the numeric keypad to skip directly to a DVD chapter or CD track while a disc is playing.
- Use the numeric keypad to input numeric data in menu option fields when possible.

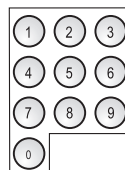

Adjusting the Volume

- Turn the Volume Control dial to adjust the volume level up or down.
- Press MUTE to turn the volume off completely; press mute again to restore the volume to its previous level.

Disc Error Messages

The following messages will be displayed on-screen if there is a problem with the format of the loaded disc.

- **WRONG REGIONAL DISC.** The region code of the disc does not match the player's region code (Region 1).
- **WRONG PASSWORD.** The parental rating level of the disc is higher than the parental rating level setting of the player. The player will not play the disc.
- **WRONG DISC.** The player is equipped with automatic disc quality detection software. If the player detects a disc that is damaged or has a format problem, it may play the disc at a lower quality or stop play completely, depending on how damaged the disc is.

Note:

DVD disc production quality may vary; some discs may deviate from the industry standard. Some incorrectly-formatted discs may still play, however, the playback and operational quality of the disc may be substandard.

DISC FUNCTIONS

LCD Mode

Press the SETUP button once to adjust the brightness and contrast of the LCD screen.

1. Press the up/down NAVIGATION keys to select the desired setting to adjust. From top to bottom, the settings are: Brightness, Contrast, and Reset.
2. Press the left/right NAVIGATION keys to adjust the selected setting.
 - Use the BRIGHTNESS adjustment to make the screen brighter or darker.
 - Use the CONTRAST adjustment to display a picture with higher or lower contrast.
 - Select RESET to return the LCD mode adjustments to their factory-default settings.



Setup

Press the SETUP button twice to enter the player's setup menu. Enter the Setup menu to adjust the player's internal settings; please see the [SETUP](#) section for more details.

Display

Press the DISPLAY button:

- 1x: Title Elapsed time is shown on-screen;
- 2x: Title Remaining time is shown on-screen;
- 3x: Chapter Elapsed time is shown on-screen;
- 4x: Chapter Remaining time is shown on-screen;
- 5x: Status Information is show on-screen;
- 6x: Cancel on-screen display.

Clear

Press the CTRL/CLEAR button to reset (clear) an input field if you have made a mistake (e.g., a Time Search field).

Menu / Title

- Press the MENU button during DVD playback to return to the DVD's Main menu.
- Press the TITLE button during DVD playback to return to the DVD's Title menu. (Some discs may not have a title screen.)

DISC FUNCTIONS

Search



Press SEARCH to go directly to a desired point of a disc (e.g., Title, Chapter, Time).

DVD Chapter/Title Search:

- Press SEARCH once to display the Chapter/Title Search Bar shown to the right.
- Press the left/right NAVIGATION keys to select (highlight) an entry field.
- Use the Numeric keypad to input the desired chapter/title number, or press the up/down NAVIGATION keys to increase/decrease the chapter/title number.
- Press  to confirm and execute the search or press SEARCH to exit search mode.



DVD Time Search (within a specified title):

- Press SEARCH twice to display the Time Search Bar shown to the right.
- Use the Numeric keypad to input the desired time (hours, minutes, seconds).
- Press  to cancel any input errors.
- Press  to confirm and execute the search or press SEARCH to exit search mode.



CD Time Search:

- Press SEARCH once to display the CD Time Search Bar shown to the right.
- Use the Numeric keypad to input the desired time (hours, minutes, seconds).
- Press  to cancel any input errors.
- Press ENTER to confirm and execute the search or press SEARCH to exit search mode.



Repeat Mode

Press REPEAT to change the repeat mode of the player. Each successive press of REPEAT will change the mode as follows:

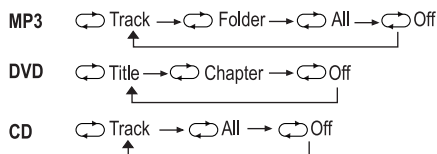

Note:

Some DVD discs do not allow Repeat mode.

DISC FUNCTIONS

Repeat A-B Mode

To repeat playback of a specific section of a disc (loop):

1. Press A-B to set the desired start point (“A”) of the section to be repeated.
2. Press A-B again to set the desired end point (“B”) of the section to be repeated.
3. The section “A-B” will now play repeatedly as a loop. Press A-B again to resume normal playback.

Multi-Angle/Subtitle/Audio

- During playback of a DVD that has been mastered with multiple angles, press ANGLE to view the available alternate camera angles. (A DVD may have up to 9 selectable angles.)
- During playback of a DVD that has been mastered with subtitles, press SUBTITLE to view the available subtitle tracks. (A DVD may have up to 32 selectable subtitles.)
- During playback of a DVD that has been mastered with alternate language/audio tracks, press AUDIO to hear the alternate tracks. (A DVD may have up to 8 selectable audio tracks.)

Zoom

Press ZOOM to change the magnification level of the picture.

- During DVD playback, each successive press of ZOOM will change the level of magnification to: Zoom 2x, Zoom 4x, Normal.
- During JPEG CD playback, each successive press of ZOOM will change the level of magnification to: 25%, 50%, 100%, 150%, 200%.

When the magnification level is greater than Normal/100%, use the NAVIGATION keypad to pan around the magnified picture.

Note: The picture quality will decrease as the zoom level increases.

Program

Enter Program mode to create a custom sequence of tracks to be played.

(Program mode is available only when the player is in NAVIGATE OFF mode. Press the PBC key to set the player to NAVIGATE OFF mode.)

Note: You can also use the numeric keypad to enter numbers directly in the fields. Use the navigation keys to move between entry fields.

DVD Program Mode

1. Load a DVD and press PROGRAM.
2. Press the RIGHT navigation key to select the “Title” column; press the UP/DOWN navigation keys to select a title.
3. Press RIGHT to select the “Chapter” column; press UP/DOWN to select a chapter.
4. Press ENTER to confirm the selection.

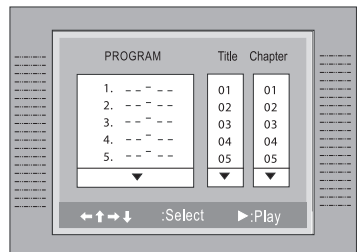

DISC FUNCTIONS

- Repeat steps 2-4 until you have finished programming your selections or when you have programmed the maximum 20 tracks.
- Press PLAY to start playback. Press PROGRAM to cancel.

CD Program Mode

- Load a CD and press PROGRAM.
- Press the RIGHT navigation key to select the "Track" column; press the UP/DOWN navigation keys to select a track.
- Press ENTER to confirm the selection.
- Repeat steps 2-3 until you have finished programming your selections or when you have programmed the maximum 20 tracks.
- Press PLAY to start playback. Press PROGRAM to cancel.

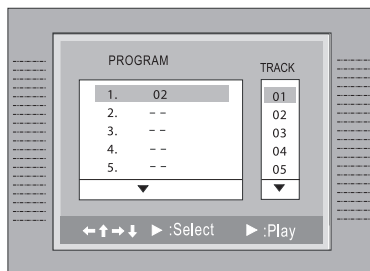

MP3 Program Mode

- Load an MP3-CD and press PROGRAM.
- Use the navigation keys to select the desired file.
 - To navigate through subfolders: press the LEFT/RIGHT navigation keys to enter/exit a folder.
- Press RIGHT to confirm. The confirmed file will be marked as a programmed file.
- Repeat steps 2-3 until you have finished programming your selections or when you have programmed the maximum 20 tracks.
- Press ENTER to confirm the selection.
- Press PLAY to start playback. Press PROGRAM to cancel.

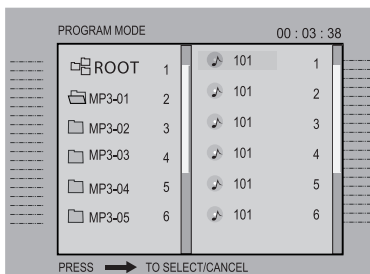

SETUP

Enter Setup mode to adjust the various internal settings of the player. Make sure the player has been completely stopped before entering Setup mode.

1. Press **SETUP** to enter Setup mode.
2. Use the Navigation Keypad to select a desired item.
3. Press **ENTER** to confirm a selection.
4. Press **SETUP** to exit Setup mode (or select **EXIT** and press **ENTER**).

Language Setup

Use the Navigation Keypad to highlight the desired language selection and press **ENTER** to confirm.

Item	Description	Options (Default is in Bold)
OSD	Sets the language of the player's on-screen display.	English , French, German, Italian, Spanish, Portuguese, Dutch, Polish
Menu	Sets the default menu language of loaded DVDs.	English , Chinese, Japanese, French, German, Italian, Spanish, Portuguese, Hindi, Thai, Russian, Korean, Others
Audio	Sets the default language audio track of loaded DVDs.	English , Chinese, Japanese, French, German, Italian, Spanish, Portuguese, Hindi, Thai, Russian, Korean, Others
Subtitle	Sets the default subtitle track of loaded DVDs.	English , Chinese, Japanese, French, German, Italian, Spanish, Portuguese, Hindi, Thai, Russian, Korean, Others

Screen Setup

Use the Navigation Keypad to highlight the desired screen selection and press **ENTER** to confirm.

Item	Description	Options (Default is in Bold)
TV Type	Sets the aspect ratio of the display.	4:3 PS, 4:3 LB, 16:9
Screen Saver	The screensaver prevents burn-in damage to the player's screen.	On, Off
TV System	Sets the player's Video Out signal type. Set this to correspond with your TV.	NTSC , PAL, Auto

SETUP

Audio Setup

Use the Navigation Keypad to highlight the desired audio selection and press ENTER to confirm.

Item	Description	Options (Default is in Bold)
Digital Out	Sets the player's Optical Out (audio) signal. For use with 5.1-channel receivers (see your receiver's manuals for more details).	SPDIF/PCM, SPDIF/RAW , Off

Custom Setup

Use the Navigation Keypad to highlight the desired Custom Setup selection and press ENTER to confirm.

Item	Description	Options (Default is in Bold)
Parental Ctrl	Sets the maturity rating level of the player. The player will not play any discs rated higher than this setting. <u>This setting is password protected (the default password is: 8888).</u>	Levels 1 to 8. (8: ADULT is default)
Password	Change the Parental Ctrl password. Enter the old password, the new password, and then the new password again to verify. DO NOT FORGET THE PASSWORD; this password cannot be reset.	
Angle Mark	Displays an on-screen prompt whenever an alternate angle becomes available for viewing (press ANGLE to view).	On , Off
Default	Resets all settings to their factory-default state. This will not reset the Parental Ctrl password.	Read

TROUBLESHOOTING

If you have a problem with this player, please read the troubleshooting guide below and check our website at www.cobyusa.com for Frequently Asked Questions (FAQs) and firmware updates. If these resources do not resolve the problem, please contact Technical Support.

COBY Electronics Technical Support

56-65 Rust St.
Maspeth, NY 11378

Hours: Monday to Friday, 8:30 AM–11:00 PM EST
Saturday to Sunday, 9:00 AM–11:00 PM EST

Email: techsupport@cobyusa.com

Phone: 800-681-2629 or 718-416-3197

Web: www.cobyusa.com

There is no power to the device.

- Ensure that the Power Switch is physically set to the ON position.
- Ensure that the AC adapter cord is securely connected to the player and the proper wall outlet.
- Ensure that the battery pack is fully charged.

The device does not play.

- Ensure that a supported disc is loaded in the player label-side up.
- Ensure that the disc's rating level does not exceed the player's.
- Ensure that the disc is not damaged or too dirty. Clean the disc or try another disc.
- Ensure that the disc type is compatible with the player.
- Moisture may have condensed inside the player. Remove the disc and leave the player on for 1-2 hours and then try again.

There is no picture.

- Ensure that the TV set has been powered on and is set to the correct AV mode.
- Ensure that the connections between the player and the TV are secure and correct.
- Check if the connection cables are damaged.

The picture is noisy or distorted.

- The disc may be damaged or dirty. Clean the disc or try another one.
- Reset your TV's color system.
- Ensure that the player is connected directly to the TV (and not through a VCR, cable box, satellite receiver, etc.)

There is no sound or distorted sound.

- Ensure that the TV and/or amplifier have been turned on and properly set up.
- Ensure that the TV and/or amplifier connections are secure and correct.
- Try a different Audio track of the DVD by pressing AUDIO.
- Ensure that the MUTE function of the TV, Amplifier, or Player is not engaged.

TROUBLESHOOTING

The remote control doesn't work.

- Ensure that the Power Switch has been physically set to the ON position.
- Ensure that there are no obstacles between the remote and the player.
- Point the remote at the remote sensor on the main unit.
- Ensure that the batteries in the remote retain a charge and have been installed correctly.
- Try replacing the remote's batteries.

The player has malfunctioned.

- Unplug the player and remove the battery pack for 30 minutes. After that, reinstall the battery and plug in the player. Power on the player -- the restore function should reset the player.

SPECIFICATIONS

Power Supply	DC: 9V, 2A AC: 100-240V UL Listed Adapter Rechargeable Battery
Power Consumption	≤ 9W
Video Signal System	NTSC
Video Output	Composite Video
Audio Output	3.5mm Headphone 3.5mm Optical / Audio Line-Out
S/N Ratio	90dB Typical
Dynamic Range (Audio)	90dB Typical
Display Type	4.5" Widescreen TFT LCD
Display Resolution	480 x 240
Unit Dimensions	6.30" x 5.43" x 1.57" (WHD) (Main Unit + Battery)
Weight	1.48 lbs (Main Unit + Battery)

Specifications and manual are subject to change without notice.

NOTES

NOTES

COBY Electronics Corp.

56-65 Rust Street
Maspeth, NY 11378

www.cobyusa.com
www.ecoby.com