

# DVD Player

---

Operating Instructions \_\_\_\_\_

US

## Owner's Record

The model and serial numbers are located on the bottom of the unit.

Record these numbers in the space provided below.

Refer to these numbers whenever you call upon your Sony dealer regarding this product.

Model No. MV-101 Serial No. \_\_\_\_\_

For installation and connections, see the supplied installation/connections manual.



## MV-101

## Warning

You are cautioned that any changes or modifications not expressly approved in this manual could void your authority to operate this equipment.

### CAUTION

The use of optical instruments with this product will increase eye hazard.

### CAUTION

Use of controls or adjustments or performance of procedures other than those specified herein may result in hazardous radiation exposure.

**DANGER — INVISIBLE LASER RADIATION WHEN OPEN.  
AVOID DIRECT EXPOSURE TO BEAM.**

This is located on the drive unit's internal chassis.

## Welcome !

Thank you for purchasing this Sony DVD Player. You can enjoy its various features even more with:

- DVD/Video CD/Audio CD playback.
- Support DTS/Dolby digital through optical digital output terminal.
- MP3 file playback.
- CD-R/CD-RW which can have a session added can be played (page 5).
- **Supplied controller accessory**  
Card remote commander  
RM-X135

## Copyrights

This product incorporates copyright protection technology that is protected by method claims of certain U.S. patents, other intellectual property rights owned by Macrovision Corporation, and other rights owners. Use of this copyright protection technology must be authorized by Macrovision Corporation, and is intended for home and other limited viewing uses only unless otherwise authorized by Macrovision Corporation. Reverse engineering or disassembly is prohibited.

Manufactured under license from Dolby Laboratories. "Dolby", "Pro Logic", and the double-D symbol are trademarks of Dolby Laboratories. Confidential unpublished works. Copyright 1998-1999 Dolby Laboratories. All rights reserved.

"DTS," "DTS Digital Surround" and "DTS Digital Out" are trademarks of Digital Theater Systems, Inc.



---

# Table of Contents

Precautions .....	4
About this manual .....	4
About discs this player can play .....	5
Notes on discs .....	7
About MP3 files .....	8
Location of controls .....	10

## Getting Started

Resetting the player .....	12
----------------------------	----

## DVD/Video CD/

### CD Player

Playing a disc .....	13
Searching a chapter/title/track directly .....	14
Resume playback .....	14
Turning off this player .....	14
MP3 file playback with the menu display .....	15
Displaying running time .....	15
Changing the subtitle language .....	16
Using a DVD menu .....	17
Using the TOP MENU button .....	17
Using the MENU button .....	17
Changing the audio language .....	18
Changing angles .....	18
Changing the audio output .....	19
Using the PBC (playback control) function ....	19

## Changing Setup Changing the audio language

## Precautions

To avoid the risk of injury or accident, read the following precautions before installing and operating the player.

### For driver's safety

Comply with your local traffic rules and regulations.

- While driving
  - The driver must not watch or operate the player. It may lead to distraction and cause an accident. Park your car in a safe place to watch and operate the player.
- While operating
  - Do not insert your hands, fingers or foreign object into the player. It may cause injury or damage to the player.
  - Keep small articles out of the reach of children.
- If the player does not work, check the connections first. If everything is in order, check the fuse.
- If your car was parked in direct sunlight, allow the player to cool off before operating it.
- Avoid installing the player in places:
  - subject to temperature below  $-30\text{ }^{\circ}\text{C}$  ( $-22\text{ }^{\circ}\text{F}$ ) or above  $65\text{ }^{\circ}\text{C}$  ( $113\text{ }^{\circ}\text{F}$ ).
  - subject to direct sunlight.
  - near heat sources (such as heaters).
  - exposed to rain or moisture.
  - exposed to excessive dust or dirt.
  - subject to excessive vibration.
  - subject to heat:
    - Keep all products away from nearby hot vehicle components that heat up over time such as hoses, high current wires, and braking systems components. Make sure to leave enough room for ventilation on openings and slots to protect from over heating.

If you have any questions or problems concerning this player, please consult your nearest Sony dealer.

### Moisture condensation

On a rainy day or in a very damp area, moisture condensation may occur inside the lenses. Should this occur, the player will not operate properly. In such a case, remove the disc and wait for about an hour until the moisture has evaporated.





### To maintain high sound quality

Be careful not to splash juice or other soft drinks onto the player or discs.

## About this manual

### Conventions

- Instructions in this manual describe how to use this player by using the controls on the supplied wireless remote commander.
- The icons below are used in this manual:

Icon	Meaning
	Indicates a DVD function.
	Indicates a Video CD function.
	Indicates an Audio CD function.
	Indicates the function of a CD containing MP3 file.

---

# About discs this player can play

This player can play 12 cm (4 7/10 in) disc only.

- DVD
- Video CD
- Audio CD
- CD-R/CD-RW

---

Disc type	Label on the disc
DVD Videos	

---

Video CDs

---

Audio CDs	
-----------	---

---

MP3 files



## Notes on CD-Rs (recordable CDs)/ CD-RWs (rewritable CDs)

- Some CD-Rs/CD-RWs (depending on the equipment used for its recording or the condition of the disc) may not play on this unit.
- You cannot play a CD-R/CD-RW that is not finalized\*.
- You can play MP3 files recorded on CD-ROMs, CD-Rs, and CD-RWs.

\* A process necessary for a recorded CD-R/CD-RW disc to be played on the audio CD player.

**Note on PBC (Playback Control) (Video CDs)**  
 This player conforms to Ver. 1.1 and Ver. 2.0 of Video CD standards. You can enjoy two kinds of playback according to the disc type.

Disc type	You can
Video CDs without PBC functions (Ver. 1.1 discs)	Video playback (moving pictures) as well as music.
Video CDs with PBC functions (Ver. 2.0 discs)	<ul style="list-style-type: none"> <li>• Interactive software with menu screens displayed on the monitor (PBC Playback)</li> <li>• Video playback functions</li> <li>• High-resolution still pictures if they are included on the disc.</li> </ul>

**Note on DTS-encoded CDs**

When playing DTS\*-encoded CDs, excessive noise will be heard from the analog stereo outputs. To avoid possible damage to the audio system, the consumer should take proper precautions when the analogue stereo outputs of this player is connected to an amplification system. To enjoy DTS Digital Surround™ playback, an external 5.1-channel DTS Digital Surround™ decoder system must be connected to the digital output of this player.

\* "DTS," "DTS Digital Surround" and "DTS Digital Out" are trademarks of Digital Theater Systems, Inc.

**Terms for discs**

**DVD structure**

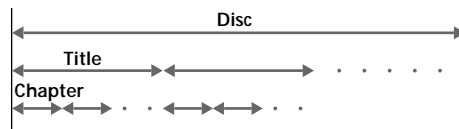

**Video CD/Audio CD structure**

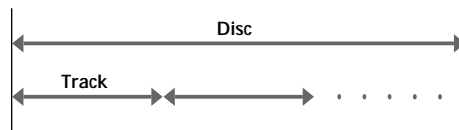

- **Title**  
 The longest section of a picture or music feature on a DVD, e.g., a movie for video software, or an album for audio software, etc.
- **Chapter**  
 Sections of a picture or a music feature that are smaller than titles. A title is composed of several chapters. Each chapter is assigned a chapter number enabling you to locate the chapter you want. Depending on the disc, chapters may not be recorded.
- **Track**  
 Sections of a picture or a music feature on a Video CD/Audio CD. Each track is assigned a track number enabling you to locate the track you want.
- **Scene**  
 On a Video CD with PBC (playback control) functions, the menu screens, moving pictures and still pictures are divided into sections called "scenes." Each scene is assigned a scene number enabling you to locate the scene you want.

## Notes on discs

- To keep the disc clean, do not touch the surface. Handle the disc by its edge.
- Keep your discs in their cases or disc magazines when not in use. Do not subject the discs to heat/high temperature. Avoid leaving them in parked cars or on dashboards/rear trays.

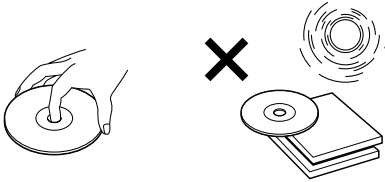

- Do not attach labels, or use discs with sticky ink/residue. Such discs may stop spinning when used, causing a malfunction, or may ruin the disc.

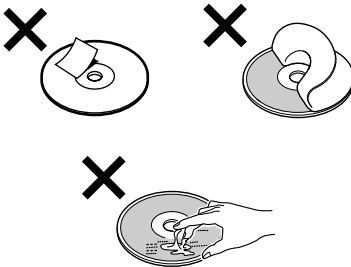

- Do not use any discs with labels or stickers attached.  
The following malfunctions may result from using such discs:
  - Inability to eject a disc (due to a label or sticker peeling off and jamming the eject mechanism).
  - Inability to read audio data correctly (e.g., playback skipping, or no playback) due to heat shrinking of a sticker or label causing a disc to warp.
- Discs with non-standard shapes (e.g., heart, square, star) cannot be played on this unit. Attempting to do so may damage the unit. Do not use such discs.

- You cannot play 8 cm (3 in) CDs.
- Before playing, clean the discs with a commercially available cleaning cloth. Wipe each disc from the center out. Do not use solvents such as benzine, thinner, commercially available cleaners, or antistatic spray intended for analog discs.



## Music discs encoded with copyright protection

This product is designed to play back discs that conform to the Compact Disc (CD) standard. Recently, various music discs encoded with copyright protection are marketed by some record companies. Please be aware that among those discs, there are some that do not conform to the CD standard and may not be playable by this product.

---

# About MP3 files

MP3 (MPEG 1 Audio Layer-3) is a standard technology and format for compressing a sound sequence. The file is compressed to about 1/10 of its original size. Sounds outside the range of human hearing are compressed while the sounds we can hear are not compressed.

---

## Recommended MP3 file format

---

Sampling frequency (Hz)	32k, 44.1k, 48k
Bitrate (bps)	32k to 256k

---

## Notes on discs

You can play MP3 files recorded on CD-ROMs, CD-Rs, and CD-RWs.

The disc must be in the ISO 9660\* level 1 or level 2 format, or Joliet or Romeo in the expansion format.

### \* ISO 9660 Format

The most common international standard for the logical format of files and folders on a CD-ROM.

There are several specification levels. In Level 1, file names must be in the 8.3 format (no more than 8 characters in the name, no more than 3 characters in the extension “.MP3”) and in capital letters. Folder names can be no longer than 8 characters. There can be no more than 8 nested folder levels. Level 2 specifications allow file names up to 31 characters long.

Each folder can have up to 8 trees.

For Joliet or Romeo in the expansion format, make sure of the contents of the writing software, etc.

## Notes

- With formats other than ISO 9660 level 1 and level 2, folder names or file names may not be displayed correctly.
- When naming, be sure to add the file extension “.MP3” to the file name.
- If you put the extension “.MP3” to a file other than MP3, the player cannot recognize the file properly and will generate random noise that could damage your speakers.
- The following discs take a longer time to start playback.
  - a disc recorded with complicated tree structure.
  - a disc to which data can be added.
- If you play a high-bit rate MP3 file such as 320 kbps, sound may be intermittent.



# The playback order of the MP3 files

The playback order of the folders and files is as follows:

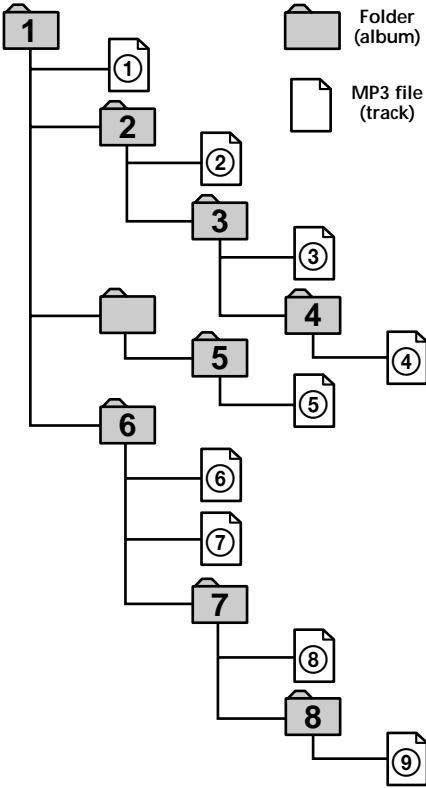

Tree 1 (root)    Tree 2    Tree 3    Tree 4    Tree 5

**Tip**  
To specify a desired playback order, before the folder or file name, input the order by number (e.g., "01," "02"), then record contents onto a disc (The order differs depending on the writing software).

# Location of controls

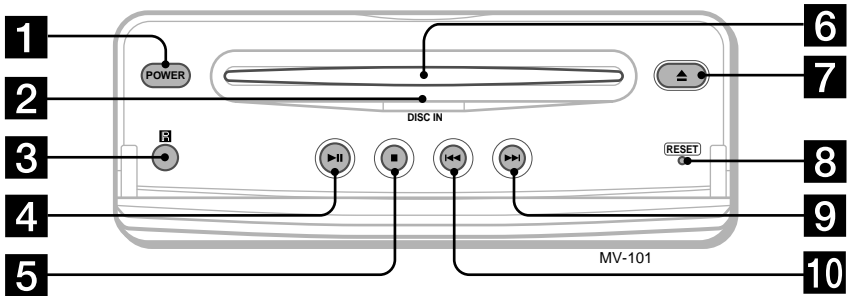
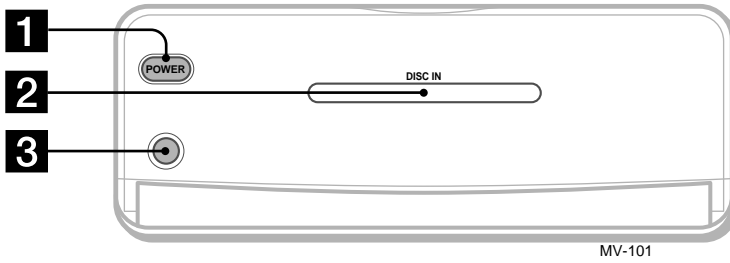

Refer to the pages listed for details.

- 1** POWER (on/off) button\*  
To turn on/off the player, press and hold the POWER button until the green light of the button is turned on/off.
- 2** DISC IN light  
When a disc is in the player, the DISC IN light glows orange.
- 3** Receptor for the card remote commander
- 4** ►|| (play/pause) button 13
- 5** ■ (stop) button 13
- 6** Disc slot
- 7** ▲ (eject) button 13  
Available to eject a disc from the player even when the player is turned off.
- 8** RESET button 12
- 9** ►► (next) button 13
- 10** ◀◀ (previous) button 13

\* **Warning when installing in a car without an ACC (accessory) position on the ignition key switch**  
Be sure to press and hold the POWER button (1) on the player until the green light of the button is turned off. Otherwise, the player is not turned off and this causes battery drain.

**Note**  
Even when the player is turned off, you can eject a disc from the player, though you cannot insert a disc.

## Card remote commander RM-X135

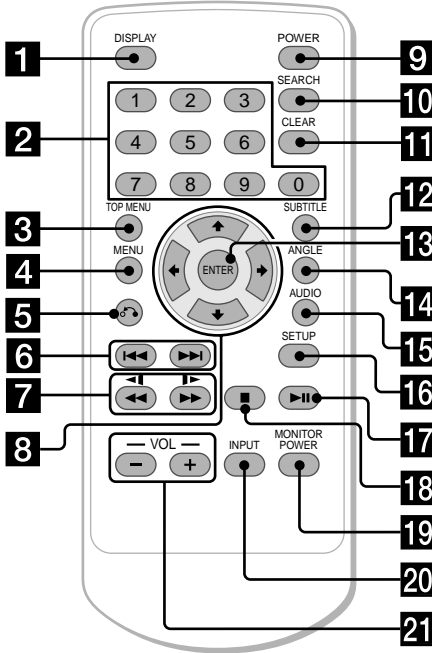

The corresponding buttons of the card remote commander control the same functions as those on the player.

Instructions in this manual describe how to use the player by mainly using the card remote commander.

### Tip

Refer to "Replacing the lithium battery" for details on how to replace the battery (page 29).

### Cautions about the POWER (on/off) button (9)

- To turn off the player, press and hold the POWER button for more than 2 seconds. The player is completely turned off. If your car has no ACC position, make sure that the green light of the POWER button (1) on the player (page 10) is turned off. Otherwise it may cause battery drain.
- To turn on the player again, be sure to press and hold the POWER button (1) (page 10) on the player until the green light of the button is turned on.

Refer to the pages listed for details.

- 1** DISPLAY button 15  
To display a running time.
- 2** Number buttons 19
- 3** TOP MENU button 17, 19  
To display the top menu of a recorded DVD or to turn on/off the PBC (Playback control) menu of a Video CD.
- 4** MENU button 17  
To display the recorded DVD menu.
- 5** ↶ (return) button 19
- 6** ⏮/⏭ (previous/next) buttons
- 7** ⏪/⏩ (fast/slow reverse)/  
⏩/⏪ (fast/slow forward) buttons
- 8** ⏶/⏷/⏸/⏵ buttons
- 9** POWER (on/off) button 13  
For details, refer to "Cautions about the POWER (on/off) button (9)."
- 10** SEARCH button 13  
To specify a desired point on a disc by chapter, title, or track.
- 11** CLEAR button

- 12** SUBTITLE button 16  
To change the subtitle language while playing a DVD
- 13** ENTER button  
To enter a setting.
- 14** ANGLE button 18  
To select the multiple angles of view while playing or pausing a DVD.
- 15** AUDIO button 18, 19  
To change the audio output/audio language.
- 16** SETUP buttons 20  
To enter or quit the setup menu.
- 17** ▶|| (play/pause) button
- 18** ■ (stop) button

### 19 MONITOR POWER (on/off) button\*

To turn on/off the monitor.

### 20 INPUT button\*

To select the input source.

### 21 VOL (-/+) buttons\*

To turn up or down the volume.

\* These buttons work for optional Sony monitors other than XVM-R75 and XVM-H6.

# Getting Started

## Resetting the player

Before operating the player for the first time, or after replacing the car battery, or after changing the connections, you must reset the player.

Open the front panel and press the RESET button with a pointed object, such as a ball-point pen.

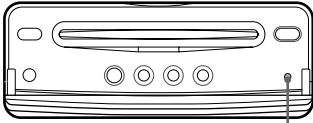

RESET button

# DVD/Video CD/ CD Player

This chapter describes how to play a disc.

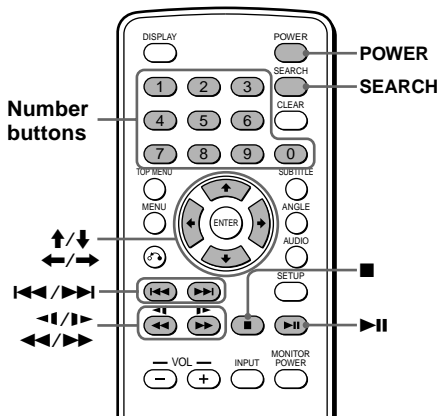

To	Do this
Stop playback	Press <b>■</b> *1
Eject the disc	Open the front panel, then press <b>▲</b> on the player.
Pause	Press <b>▶  </b> *2
Resume playback after pause	Press <b>▶▶</b>
Go to the next chapter, track, or scene in continuous play mode	Press <b>▶▶▶</b>
Go back to the preceding chapter, track, or scene in continuous play mode	Press <b>◀◀◀</b>
Fast forward	Press <b>▶▶▶/▶▶</b> while playing*3 *4
Fast reverse	Press <b>◀◀◀/◀◀</b> while playing*3 *4
Slow forward (DVD/Video CD only)	Press <b>▶▶▶/▶▶</b> in pause*4
Slow reverse (DVD only)	Press <b>◀◀◀/◀◀</b> in pause

## Playing a disc

- 1 Press **POWER** to turn on the player.
- 2 Open the front panel.
- 3 Insert the disc (labeled side up or the surface you want to play down if the disc is a DVD).

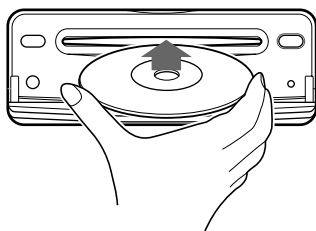

If a disc is already inserted, press **▶▶** to start playback.

### Note

Even when the player is turned off, you can eject a disc from the player, though you cannot insert a disc.

\*1 If the resume playback function is activated, you can resume playback later by pressing **▶▶**. For details, see "Resume playback."

\*2 DVD/Video CD

Both the picture and sound stop during pause and "PAUSE" is displayed on the screen.

Audio CD

The sound stops and "PAUSE" is displayed on the screen.

\*3 DVD/Video CD/Audio CD

Playback increases to 4 times the speed with no sound.

\*4 A disc other than a DVD returns to normal playback when a track/MP3 file finishes.

### Notes

- Depending on the recording method used on the disc, it may take a minute or more before playing.
- Depending on the condition of the disc, it may not play back (page 7).
- If you play a high-bit rate MP3 file such as 320 kbps, sound may be intermittent.

continue to next page →

## Searching a chapter/title/track directly

- 1 During playback or pause, press **(SEARCH)** to display search screen.
  - DVD  
Each time you press **(SEARCH)**, the search screen toggles between Title and Chapter.
  - Video CD (only when PBC is off)/Audio CD  
The track search screen appears.
- 2 Press the number buttons to enter the desired chapter/title/track number.
- 3 Press **(ENTER)**.

### Note

You cannot set "0."

## Resume playback

- 1 During playback, press **■** to stop.  
The player memorizes the point where playback is stopped.
  - DVD/Video CD/Audio CD  
"PRESS PLAY TO CONTINUE" flashes on the screen.
- 2 Press **▶||** to start playback.  
When resume playback is activated, playback starts from the point where playback is stopped. When resume playback is deactivated, playback starts from the beginning.
  - MP3  
When resume playback is activated, playback starts from the beginning of the MP3 file (track) during which you stopped playback.

### Notes

- To deactivate the resume function, press **■** again while playback is stopped or eject the disc from the player.
- The player stores the point where you stopped playback for the disc currently in the player.
- The resume function will be deactivated:
  - when the disc is ejected.
- If the resume function is activated during fast/slow forward or fast/slow reverse playback, normal playback starts when you press **▶||**.

## Turning off this player

Press **(POWER)** to turn off this player.

## MP3 file playback with the menu display

If you have set “SMART NAV” to “WITH MENU” (page 28) and play a CD containing MP3 files, the menu display for folder names and MP3 file names will appear. You can easily search the desired MP3 file with the “SMART NAV” menu display.

- 1 Insert a CD containing MP3 files in this player.  
The “SMART NAV” menu display appears.

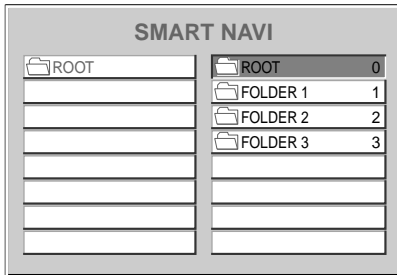

- 2 Press the number buttons to select the desired folder.  
 ↑/→/↓/← buttons are also available to select the desired folder.  
 If you select the folder 1, the MP3 file names in the folder 1 appear.

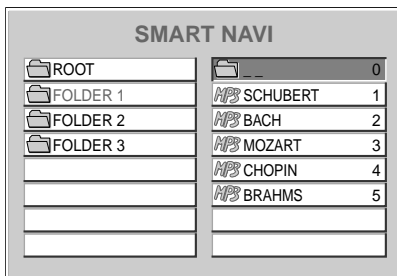

- 3 Press the number buttons to select the desired MP3 file.  
 ↑/→/↓/← buttons are also available to select the desired MP3 file.  
 Playback starts.

To turn off the menu display for MP3 files, set “SMART NAV” to “NO MENU” (page 28).

### Note

To deactivate the resume function, press  again while playback is stopped or eject the disc from the player.

## Displaying running time



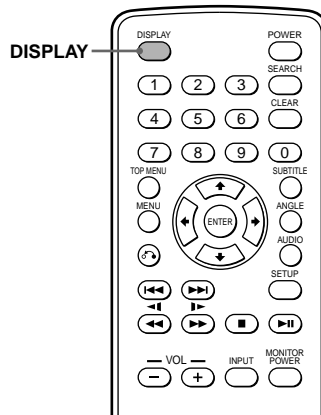

You can display the running time of DVDs, Video CDs and Audio CDs.

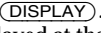

During playback, press . The running time is displayed at the upper left.

### • DVD

- 1 Press  while the running time is displayed.
- 2 Each time you press , the display changes as follows:

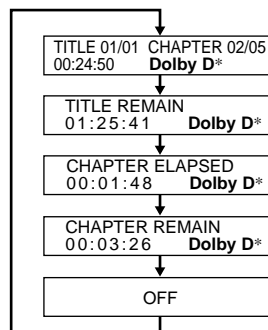

\* The format of the sound source (Dolby D, DTS, or LPCM) may appear.

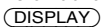
To exit the display for running time, press  repeatedly to select “OFF.”

continue to next page →

- Video CD (when PBC is set to OFF)/CD
  - ➊ Press **(DISPLAY)** while the running time is displayed.
  - ➋ Each time you press **(DISPLAY)**, the display changes as follows:

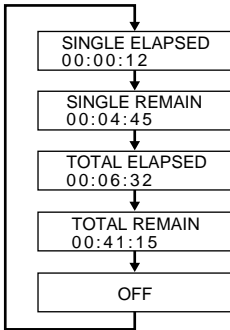

To exit the display for running time, press **(DISPLAY)** repeatedly to select “OFF.”

## Changing the subtitle language

Some DVDs have recorded subtitles in one or more languages. You can turn the subtitles on or off, or change the subtitle language on such DVDs.

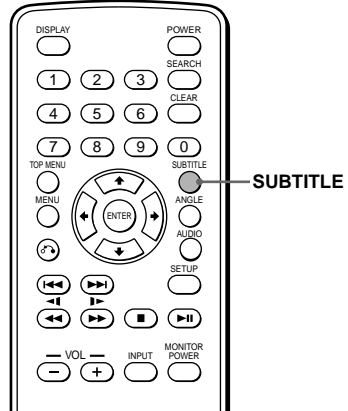

Press **(SUBTITLE)**, during playback. The subtitle language is displayed at the upper left.

Example: a subtitle language display

SUBTITLE 02/32 : ENGLISH

Each time you press **(SUBTITLE)**, the language switches within the list of subtitle languages recorded on the disc. When the display for the language code appears, input the language code corresponding to the desired language (page 34).

### Notes

- You can also change the subtitle languages by changing Setup\*. See “Displaying the subtitles for DVD — SUBTITLE” (page 25).
- \* You can change to a specific subtitle language using a setup menu, only if the language is included in both the disc and the setup screen.
- If you want to hide the subtitles, press **(SUBTITLE)** repeatedly to select “OFF.”
- This function varies or may not work, depending on the DVD.



## Using a DVD menu

With some DVDs you can use the original menu such as Title menu and DVD menu. You can play your favorite scene or song by selecting titles of songs and scenes during a DVD playback. You can select an item, subtitle language, audio language etc. by selecting a DVD menu. The contents of title menus and DVD menus differ, depending on the DVD. There may be some DVDs which have no recorded menus.

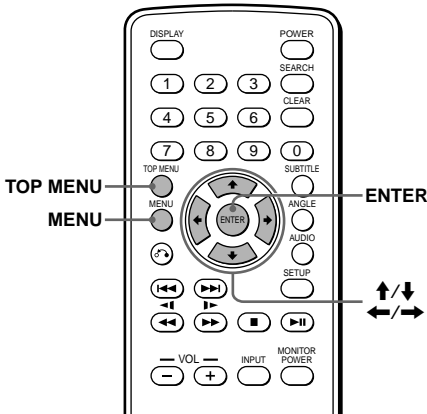

### Using the TOP MENU button

Some DVDs have a title menu. From the title menu you can select a title for playback. Titles are the longest sections of a picture or music feature on a DVD, e.g., a movie, or an album for audio software, etc. The TOP MENU button is available to display the initial menu screen.

- 1 During DVD playback, press **TOP MENU**.  
The top menu\* (titles) is displayed.  
*\* The contents of the top menu differ, depending on the DVD.*
- 2 Press **↑/→/↓/←** to select the desired title.
- 3 Press **ENTER**.  
The title you selected starts to play.

## Changing the audio language

Some DVDs have multiple audio languages you can choose from.

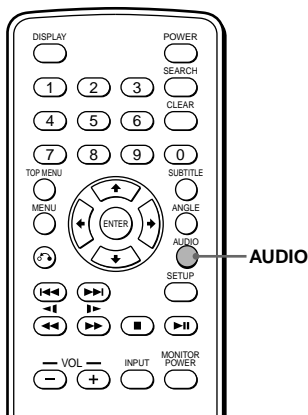

During playback, press **AUDIO** repeatedly to select the desired audio language.

The current audio language is displayed at the upper left.

Example: an audio language display

AUDIO 1/2: Dolby D 5.1 ENGLISH

The format of the sound source (Dolby D, DTS, or LPCM) may appear.

When the display for the language code appears, input the language code corresponding to the desired language (page 34).

### Notes

- You can switch the audio language only if multiple audio languages are recorded on the DVD.
- You can also change the audio languages by using the DVD menu (page 17) or the setup screen\* (page 24).
- \* You can change to a specific audio language using a setup screen, only if the language is included in both the disc and the setup screen.
- This function varies or may not work, depending on the DVD.

## Changing angles

Some DVDs have multiple alternative angles recorded for certain scenes. If you have set “ANGLE MARK” to “ON” (page 21), a notice appears for 3 seconds at the scene. If “ANGLE MARK” is not set to “ON,” the notice does not appear at the scene.

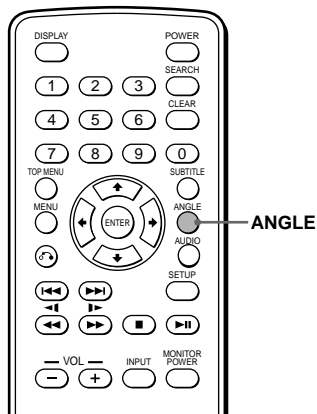

- 1 During playback of a DVD having multiple alternative angles recorded, press **ANGLE** when a notice appears. The number of the currently selected angle is displayed at the upper right.

- 2 Press **ANGLE** repeatedly to select your favorite angle number, while the angle number is displayed. Each time you press **ANGLE**, the angle number switches.



The angle number you have currently selected/the total number of multiple alternative angles

### Notes

- You can switch the angle only if multiple angles are recorded on the DVD.
- The total number of recorded angles differs depending on the DVD and scene.
- You can only switch the angle during normal playback. You cannot switch the angle during fast forward/reverse playback.
- When the selected scene with multi angles appears, the angle is automatically switched to the angle number you selected in step 2.

## Changing the audio output



You can select the desired audio output from "STEREO," "L-MONO," "R-MONO," or "MIX-MONO" during Video CD or Audio CD playback.

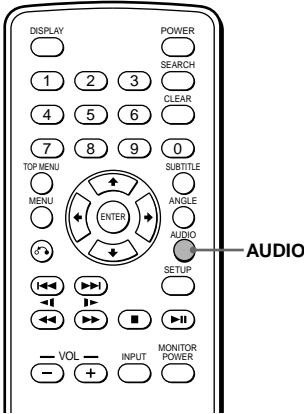

- 1 During playback, press **(AUDIO)**.  
The current output is displayed at the upper left.

Example: an audio output display

**L-MONO**

- 2 Press **(AUDIO)** to select the desired output from "STEREO," "L-MONO," "R-MONO," or "MIX-MONO" while the output is displayed.  
Each time you press **(AUDIO)**, the output switches.

## Using the PBC (playback control) function



During playback of a PBC compatible Video CD, you can display the PBC menu and select the item from the menu.

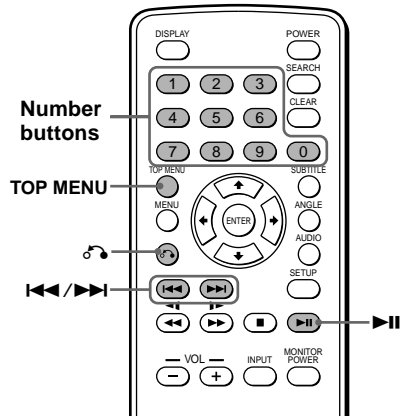

- 1 Insert a Video CD, then press **(TOP MENU)** repeatedly to select "PBC ON."  
Depending on the Video CD, the PBC menu may be displayed automatically after inserting a Video CD.  
Each time you press **(TOP MENU)**, the PBC menu function turns on or off.
- 2 Press **▶▶**.  
The PBC menu is displayed.
- 3 While the PBC menu screen is displayed;
  - press the number buttons to select the number of the desired item.
  - press **◀◀/▶▶** to go to the previous/next page.
 Button functions vary or may not work, depending on the Video CD.

### Notes

- To display the PBC menu during playback of a Video CD, press **(TOP MENU)** repeatedly to select "PBC ON," then press **▶▶**.
- During playback of a Video CD with "PBC ON," press the number buttons or **◀◀/▶▶** to change the item. The PBC menu is not displayed but the item you selected starts to play.
- During playback of a Video CD with "PBC ON," press **⏸** to display the PBC menu.
- The PBC menus differ, depending on the Video CD. Read the instruction manual supplied with the Video CD.

# Changing Setup

You can set up and adjust this player using the on-screen setup menu. Most settings need to be set when you first use this player.

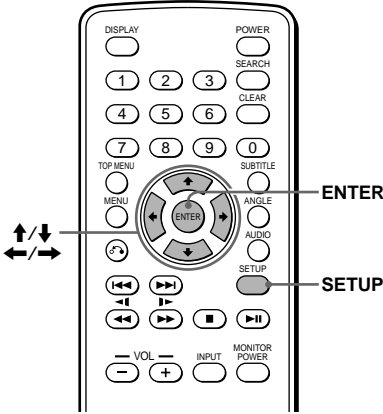

- 3 Press **↑** or **↓** repeatedly to select "ANGLE MARK," then press **→**.

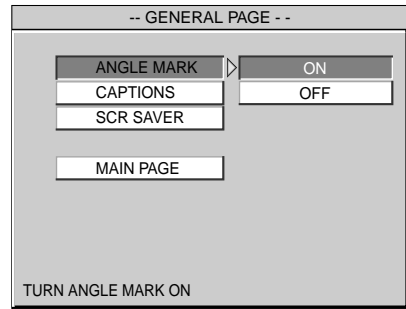

- 4 Press **↑** or **↓** repeatedly to select "ON."

- 5 Press **(ENTER)**.  
"ANGLE MARK ON" is displayed at the lower left on the monitor.

To turn off the multi-angle notice, select "OFF" in step 4.

To return to normal play screen, press **(SETUP)** anytime.

### Note

To return to the main page for setup, press **↑/↓/←** repeatedly to select "MAIN PAGE," then press **(ENTER)**.

## Displaying the multi-angle notice — ANGLE MARK

If various angles (multi-angles) for a scene are recorded on the DVD and you have set the "ANGLE MARK" to "ON," a notice appears at the scene.

- 1 Press **(SETUP)**.  
The main page for setup appears.  
"PREFERENCES" is only available when playback is stopped.

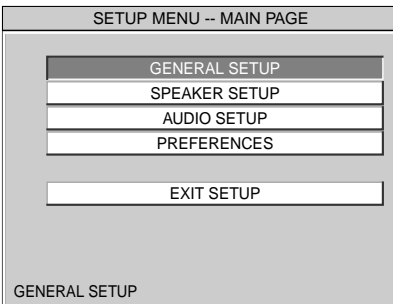

- 2 Press **↑** or **↓** repeatedly to select "GENERAL SETUP," then press **(ENTER)**.

# Displaying captions for viewers with hearing difficulties — CAPTIONS

## Note

To return to the main page for setup, press **↑/↓/←** repeatedly to select "MAIN PAGE," then press **(ENTER)**.

Captions are the words displayed on the monitor that describe the audio or sound portion of a DVD. Captions allow viewers with hearing difficulties to follow the dialog and the action of a scene simultaneously. This function is only available when a DVD containing captions is played.

### 1 Press **(SETUP)**.

The main page for setup appears. "PREFERENCES" is only available when playback is stopped.

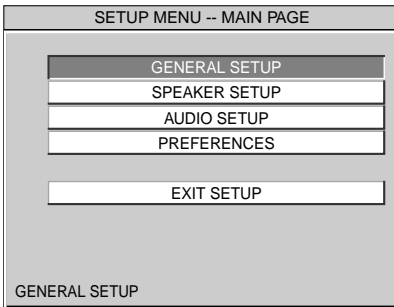

### 2 Press **↑** or **↓** repeatedly to select "GENERAL SETUP," then press **(ENTER)**.

### 3 Press **↑** or **↓** repeatedly to select "CAPTIONS," then press **→**.

### 4 Press **↑** or **↓** repeatedly to select "ON."

### 5 Press **(ENTER)**.

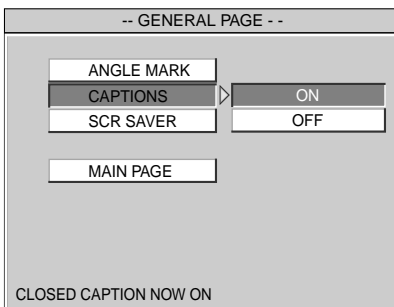

To turn off the captions, select "OFF" in step 4.

To return to normal play screen, press **(SETUP)** anytime.

# Setting the screen saver

— SCR SAVER

If you set the “SCR SAVER” setting to “ON,” the screen saver image appears when you leave the player in pause or stop mode for more than 15 minutes. The screen saver will help prevent the monitor from becoming damaged.

- 1 Press **(SETUP)**.  
The main page for setup appears.
- 2 Press **↑** or **↓** repeatedly to select “GENERAL SETUP,” then press **(ENTER)**.
- 3 Press **↑** or **↓** repeatedly to select “SCR SAVER,” then press **→**.
- 4 Press **↑** or **↓** repeatedly to select “ON.”
- 5 Press **(ENTER)**.

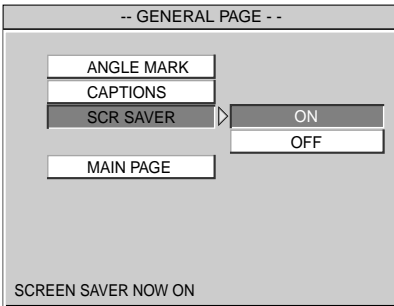

To turn off the screen saver setting, select “OFF” in step 4.

To return to normal play screen, press **(SETUP)** anytime.

### Note

To return to the main page for setup, press **↑/↓/←** repeatedly to select “MAIN PAGE,” then press **(ENTER)**.

# Selecting the speaker mode

— SPEAKER SETUP 

You can select the speaker mode setting from “LT-RT” or “STEREO.” The downmix function is used to create stereo (2-channel) signals from more than 5 separated digital signals of a source.

LT-RT: theater downmix mode.

STEREO: stereo downmix mode.

- 1 Press **(SETUP)**.  
The main page for setup appears.
- 2 Press **↑** or **↓** repeatedly to select “SPEAKER SETUP,” then press **(ENTER)**.
- 3 Press **↑** or **↓** repeatedly to select “DOWNMIX,” then press **→**.

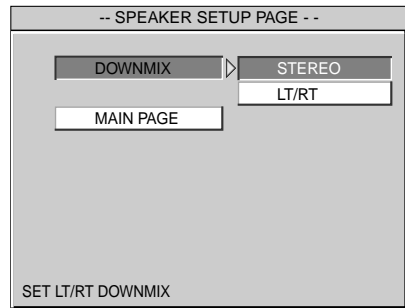

- 4 Press **↑** or **↓** repeatedly to select the desired item from “LT/RT” or “STEREO.”
- 5 Press **(ENTER)**.  
“LT/RT DOWNMIX” is displayed at the lower left on the monitor, for example if you select “LT/RT” in step 4.

To return to normal play screen, press **(SETUP)** anytime.

### Note

To return to the main page for setup, press **↑/↓/←** repeatedly to select “MAIN PAGE,” then press **(ENTER)**.

## Selecting the audio output mode — AUDIO OUT

You can select the audio output setting from “SPDIF/RAW” or “SPDIF/PCM.”

SPDIF (Sony/Philips Digital Interface) is a standard of audio transfer file format. SPDIF allows the transfer of audio, however, signal quality may be degraded.

**SPDIF/RAW:** outputs the original audio data in SPDIF format.

**SPDIF/PCM:** outputs the sampling of the original audio data in SPDIF format.

- 1 Press **(SETUP)**.  
The main page for setup appears.
- 2 Press **↑** or **↓** repeatedly to select “AUDIO SETUP,” then press **(ENTER)**.
- 3 Press **↑** or **↓** repeatedly to select “AUDIO OUT,” then press **→**.

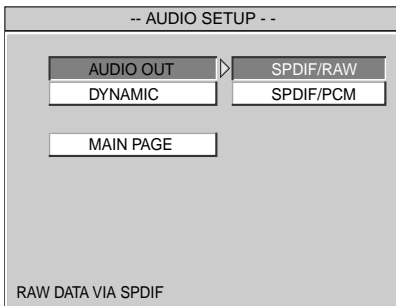

- 4 Press **↑** or **↓** repeatedly to select the desired item from “SPDIF/RAW” or “SPDIF/PCM.”
- 5 Press **(ENTER)**.  
“SPDIF/RAW OUTPUT” is displayed at the lower left on the screen, for example if you select “SPDIF/RAW” in step 4.

To return to normal play screen, press **(SETUP)** anytime.

### Note

To return to the main page for setup, press **↑/↓/←** repeatedly to select “MAIN PAGE,” then press **(ENTER)**.

## Selecting the compression setting for the sound

### — DYNAMIC

You can select the compression setting for the sound. If you set the DYNAMIC setting to “OFF” and watch an exciting movie, you can enjoy dynamic sound to its best effect.

However, for example, if the sound is too dynamic and loud to hear low level sound such as human voices, try adjusting the dynamic range.

- 1 Press **(SETUP)**.  
The main page for setup appears.
- 2 Press **↑** or **↓** repeatedly to select “AUDIO SETUP,” then press **(ENTER)**.
- 3 Press **↑** or **↓** repeatedly to select “DYNAMIC,” then press **→**.

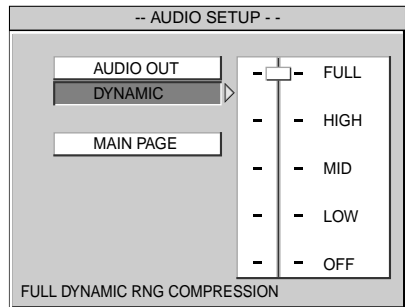

- 4 Press **↑** or **↓** repeatedly to select the desired item from “FULL,” “HIGH,” “MID” or “LOW.”
- 5 Press **(ENTER)**.

To turn off the dynamic range of sound volume, select “OFF” in step 4.

To return to normal play screen, press **(SETUP)** anytime.

### Note

To return to the main page for setup, press **↑/↓/←** repeatedly to select “MAIN PAGE,” then press **(ENTER)**.

## Selecting the TV color system — COLOR SYSTEM



The color system differs, depending on your country. You can change the TV color system for the monitor.

- 1 Press **SETUP**.  
The main page for setup appears.
- 2 Press **↑** or **↓** repeatedly to select "PREFERENCES," then press **ENTER**.
- 3 Press **↑** or **↓** repeatedly to select "COLOR SYSTEM," then press **→**.

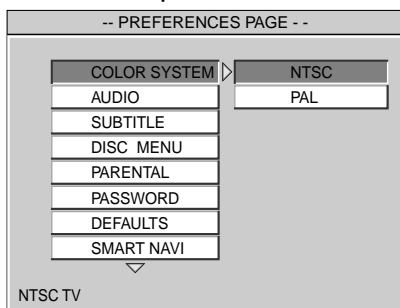

- 4 Press **↑** or **↓** repeatedly to select the desired item from "NTSC" or "PAL."
- 5 Press **ENTER**.  
"SET TO NTSC" is displayed at the lower left on the screen, for example if you select "NTSC" in step 4.

To return to normal play screen, press **SETUP** anytime.

### Notes

- To return to the main page for setup, press **↑/↓/←** repeatedly to select "MAIN PAGE," then press **ENTER**.
- If your connected monitor is not PAL compatible, do not set "COLOR SYSTEM" to "PAL," as your monitor will not display, and operations will not be possible.

## Selecting the audio language for DVD



Some DVDs have multiple audio languages you can select from.

- 1 Press **SETUP**.  
The main page for setup appears.
- 2 Press **↑** or **↓** repeatedly to select "PREFERENCES," then press **ENTER**.
- 3 Press **↑** or **↓** repeatedly to select "AUDIO," then press **→**.

- 4 Press **↑** or **↓** repeatedly to select the desired item from "ENGLISH," "FRENCH," "SPANISH," "JAPANESE."  
If you select "OTHERS," select and enter a language code from "Language Code List" (page 34).

- 5 Press **ENTER**.  
"PREFERENCE SET TO ENGLISH" is displayed at the lower left on the screen, for example if you select "ENGLISH" in step 4.

To return to normal play screen, press **SETUP** anytime.

### Notes

- To return to the main page for setup, press **↑/↓/←** repeatedly to select "MAIN PAGE," then press **ENTER**.
- Regardless of setting to the desired language, other language may be automatically activated, depending on the DVD.



## Displaying the subtitles for DVD — SUBTITLE

If subtitles are recorded on the discs, you can change the subtitles or turn the subtitles on and off when playback is stopped or the disc is ejected.

- 1 Press **(SETUP)**.  
The main page for setup appears.
- 2 Press **↑** or **↓** repeatedly to select "PREFERENCES," then press **(ENTER)**.
- 3 Press **↑** or **↓** repeatedly to select "SUBTITLE," then press **→**.

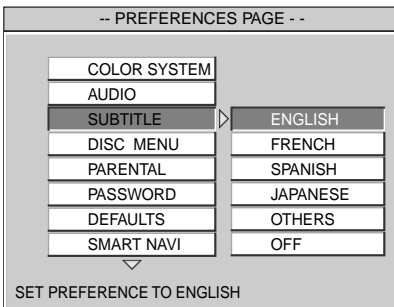

- 4 Press **↑** or **↓** repeatedly to select the desired item from "ENGLISH," "FRENCH," "SPANISH," "JAPANESE."  
If you select "OTHERS," select and enter a language code from "Language Code List" (page 34).
- 5 Press **(ENTER)**.  
"REFERENCE SET TO ENGLISH" is displayed at the lower left on the screen, for example if you select "ENGLISH" in step 4.

To turn off the subtitle select "OFF" in step 4.

To return to normal play screen, press **(SETUP)** anytime.

### Notes

- To return to the main page for setup, press **↑/↓/←** repeatedly to select "MAIN PAGE," then press **(ENTER)**.
- Regardless of setting to the desired language, other language may be automatically activated, depending on the DVD.

## Selecting the DVD menu language — DISC MENU

You can select the display language for the DVD menu.

- 1 Press **(SETUP)**.  
The main page for setup appears.
- 2 Press **↑** or **↓** repeatedly to select "PREFERENCES," then press **(ENTER)**.
- 3 Press **↑** or **↓** repeatedly to select "DISC MENU," then press **→**.

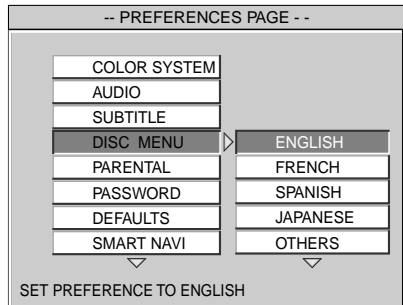

- 4 Press **↑** or **↓** repeatedly to select the desired item from "ENGLISH," "FRENCH," "SPANISH," or "JAPANESE."  
If you select "OTHERS," select and enter a language code from "Language Code List" (page 34).
- 5 Press **(ENTER)**.  
"REFERENCE SET TO ENGLISH" is displayed at the lower left on the screen, for example if you select "ENGLISH" in step 4.

To return to normal play screen, press **(SETUP)** anytime.

### Notes

- To return to the main page for setup, press **↑/↓/←** repeatedly to select "MAIN PAGE," then press **(ENTER)**.
- Regardless of setting to the desired language, other language may be automatically activated, depending on the DVD.

# Preparing for the initial parental setting

Playback of some DVDs can be limited according to a predetermined level, such as the age of the viewer. The Parental control function allows you to set a playback limitation level. When you use the unit for the first time, set a password and parental level as described below.

## Setting the password

- 1 Press **(SETUP)**.  
The main page for setup appears.
- 2 Press **↑** or **↓** repeatedly to select "PREFERENCES," then press **(ENTER)**.
- 3 Press **↑** or **↓** repeatedly to select "PASSWORD," then press **→**.

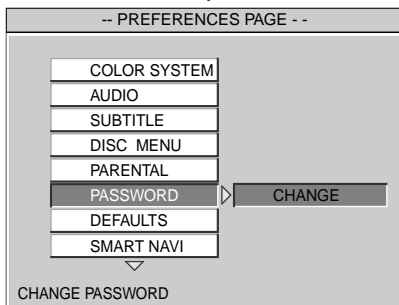

- 4 Press **(ENTER)**.  
The setup screen for setting your password is displayed.

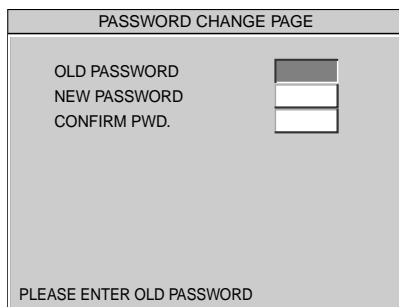

- 5 Press the number buttons to enter 5370 at "OLD PASSWORD."
- 6 Press the number buttons to enter your desired 4-digit number at "NEW PASSWORD."

- 7 Press the number buttons to enter your password\* (the same 4-digit number in step 6) again at "CONFIRM PWD."

\* If you enter a wrong number, press **(ENTER)**.  
All the numbers are cleared.

- 8 Press **(ENTER)**.

## Selecting the desired parental setting — PARENTAL

- 1 Press **(SETUP)**.  
The main page for setup appears.
- 2 Press **↑** or **↓** repeatedly to select "PREFERENCES," then press **(ENTER)**.
- 3 Press **↑** or **↓** repeatedly to select "PARENTAL," then press **→**.

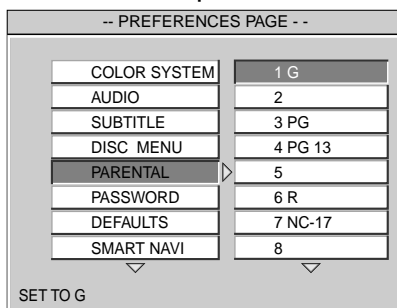

- 4 Press **↑** or **↓** repeatedly to select the desired item from "1 G," "2," "3 PG," "4 PG-13," "5," "6 PG-R," "7 NC-17," "8," or "OFF."

- 5 Press **(ENTER)**.  
The screen for password appears.

- 6 Press the number buttons to enter your 4-digit password number.  
The parental setting is completed.

**Note**  
If you forget your registered 4-digit password number, press 5370.

Refer to the following table. Parental levels of the table are on the MPAA (Motion Picture Association of America) rating system. If you set this player to level “4” for example, DVDs with levels “5,” “6,” and “7” cannot be played.

This Player	MPAA Rating System
“OFF*”	
“8”	
“7”	“NC-17”: No one 17 and under admitted
“6”	“R”: Restricted
“5”	“—”:
“4”	“PG-13”: Parents strongly cautioned
“3”	“PG”: Parental guidance suggested
“2”	“—”:
“1”	“G”: General audience

\* If you select level “OFF,” you can play all discs.

## Changing your password — PASSWORD

You can change your password for parental setting here. Follow the steps below.

- 1 Press **(SETUP)**.  
The main page for setup appears.
- 2 Press **↑** or **↓** repeatedly to select “PREFERENCES,” then press **(ENTER)**.
- 3 Press **↑** or **↓** repeatedly to select “PASSWORD,” then press **→**.

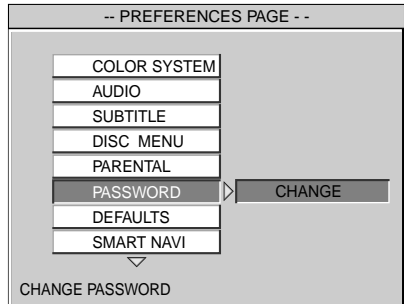

- 4 Press **→** to select “CHANGE,” and press **(ENTER)**.
- 5 Press the number buttons to enter your old password, new password, then new password again to confirm it.

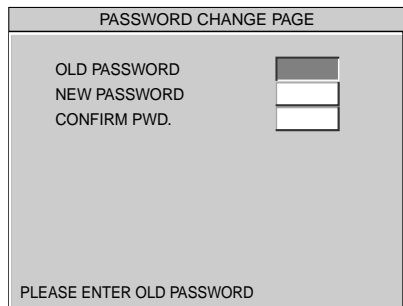

- 6 Press **(ENTER)**.

To return to normal play screen, press **(SETUP)** anytime.

### Note

If you forget your registered 4-digit password number, press 5370.

# Returning this player to the factory setting

## — DEFAULTS

You can return this player to the factory setting except your password (page 26, 27) and parental setting (page 26). Follow the steps below.

- 1 Press **(SETUP)**.  
The main page for setup appears.
- 2 Press **↑** or **↓** repeatedly to select "PREFERENCES," then press **(ENTER)**.
- 3 Press **↑** or **↓** repeatedly to select "DEFAULTS," then press **→**.

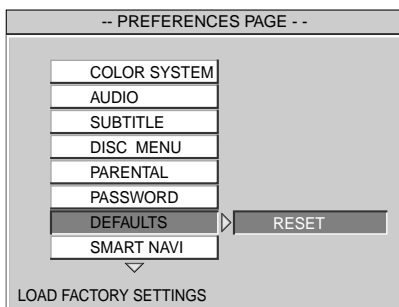

- 4 Press **→** to select "RESET."
- 5 Press **(ENTER)**.  
"FACTORY SETTINGS LOADED" is displayed at the lower left on the screen.

To return to normal play screen, press **(SETUP)** anytime.

**Note**  
To return to the main page for setup, press **↑/↓/←** repeatedly to select "MAIN PAGE," then press **(ENTER)**.

# Setting the menu display for MP3 files

## — SMART NAV

If you have set "SMART NAV" to "WITH MENU" and play a CD containing MP3 files, the menu display for folder names and MP3 file names appear. You can easily search the desired MP3 file with the "SMART NAV" menu display.

- 1 Press **(SETUP)**.  
The main page for setup appears.
- 2 Press **↑** or **↓** repeatedly to select "PREFERENCES," then press **(ENTER)**.
- 3 Press **↑** or **↓** repeatedly to select "SMART NAV," then press **→**.

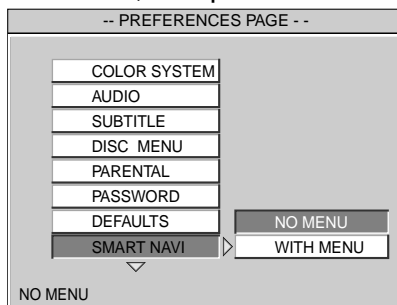

- 4 Press **→** to select "WITH MENU."
- 5 Press **(ENTER)**.  
"WITH MENU" is displayed at the lower left on the screen.

To turn off the menu display for MP3 files, select "NO MENU" in step 4.

To return to normal play screen, press **(SETUP)** anytime.

**Note**  
To return to the main page for setup, press **↑/↓/←** repeatedly to select "MAIN PAGE," then press **(ENTER)**.

# Additional Information

## Maintenance

### Fuse replacement

When replacing the fuse, be sure to use one matching the amperage rating stated on the original fuse. If the fuse blows, check the power connection and replace the fuse. If the fuse blows again after replacement, there may be an internal malfunction. In such a case, consult your nearest Sony dealer.

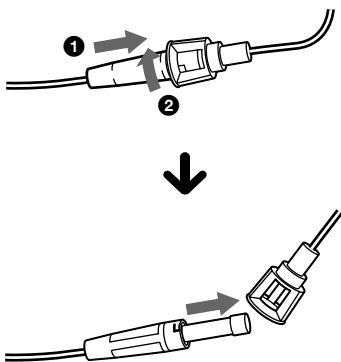

### Warning

Never use a fuse with an amperage rating exceeding the one supplied with the unit as this could damage the unit.

### Replacing the lithium battery

When the battery becomes weak, the range of the card remote commander becomes shorter. Replace the battery with a new CR2025 lithium battery. Use of any other battery may present a risk of fire or explosion.

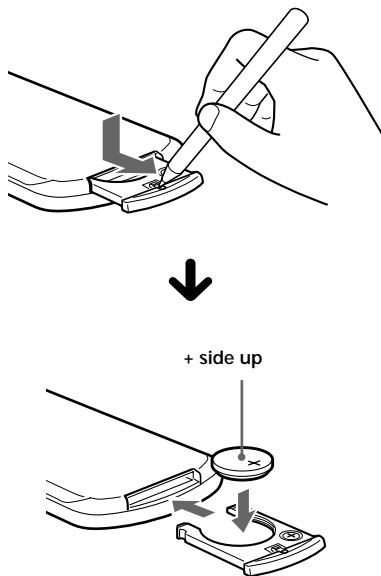

### Notes on lithium battery

- Keep the lithium battery out of the reach of children. Should the battery be swallowed, immediately consult a doctor.
- Wipe the battery with a dry cloth to assure good contact.
- Be sure to observe the correct polarity when installing the battery.
- Do not hold the battery with metallic tweezers, otherwise a short-circuit may occur.

### WARNING

Battery may explode if mistreated. Do not recharge, disassemble, or dispose of in fire.

# Specifications

## System

Laser	Semiconductor laser
Signal format system	NTSC

## Audio characteristics

Frequency response	20 Hz to 20 kHz
Signal to noise ratio	90dB (A)
Hermonic distortion	0.03 %
Dynamic range	90dB
Wow and flutter	below measurable limits (±0.001% W PEAK)

## General

Outputs	Audio output Video output Optical output
Inputs	IR input DV 12V input
Power requirements	12 V DC car battery (negative ground)
Dimensions	Approx. 189 × 70 × 243 mm (7 <sup>1</sup> / <sub>2</sub> × 2 <sup>7</sup> / <sub>8</sub> × 9 <sup>5</sup> / <sub>8</sub> in) (w/h/d)
Mass	Approx. 2.1kg (4 lb 11 oz)
Operating temperature	0 °C to 45 °C (32 °F to 113 °F)
Supplied accessories	Parts for installation and connections (1 set) Card remote commander RM-X135 Operating Instructions (1 set)
Optional equipment	Monitor XVM-R70, XVM-H65

*Design and specifications are subject to change without notice.*

---

# Troubleshooting

The following checklist will help you remedy problems you may encounter with the player. Before going through the checklist below, check the connection and operating procedures.

---

## General

---

### This player is not turned on.

- Check the connections.
- If you find the connections in order, check the fuse.  
If the fuse is blown, replace it with a correctly rated fuse.  
→ If the fuse blows again, consult your nearest Sony dealer.
- Press and hold the POWER button on the player until the POWER button lights up in green.
- The player may be overheated.  
→ Make sure that the player is completely turned off. Wait until the player cools off, then press the POWER button on the player until the POWER button lights up in green.

---

### The contents of the memory have been erased.

- The power cord or battery has been disconnected.
- The power connecting cord is not connected properly.

---

### Stored settings are erased. The fuse has blown. Makes noise when the ignition key is in the ON, ACC, or OFF position.

The leads are not matched correctly with the car's accessory power connector.

---

### No power is being supplied to the unit.

- Check the connection. If everything is in order, check the fuse.
- The car does not have an ACC position.  
→ Press and hold the POWER button on the player until the POWER button lights up in green.

---

### The power is continuously supplied to the unit.

The car does not have an ACC position.  
→ Press and hold the POWER button on the player until the green light of the POWER button is turned off.

---

---

## Disc playback

---

### A disc cannot be loaded.

- Another disc is already loaded.
- The disc is forcibly inserted upside down or in the wrong way.

---

### MP3 files cannot be played back.

- Recording was not performed according to the ISO 9660 level 1 or level 2 format, or the Joliet or Romeo convention in the expansion format.
- The file extension “.MP3” is not added to the file name.
- Files are not stored in MP3 format.

---

### MP3 files take longer to play back than others.

The following discs take a longer time to start playback.

- a disc recorded with a complicated tree structure.
- a disc to which data can be added.

---

### The sound skips due to vibration.

- The player is installed at an angle of more than 15°.
- The player is not installed in a sturdy part of the car.

---

### Playback functions such as pause are deactivated.

- The RESET button has been pressed.
- The disc is ejected.

---

### The sound skips.

Dirty or defective disc.

---

continue to next page →

## Picture

### There is no picture.

- Check that the player is connected securely.
- The connecting cord to the monitor is damaged. Replace it with a new one.
- Make sure the monitor is turned on.
- Make sure the video input is selected on the monitor to view pictures from the player.

### Picture noise appears.

Clean the disc.

## Operation

### The remote commander does not function.

- Remove any obstacles between the remote commander and the player.
- Use the remote commander closer to the remote control sensor.
- Point the light emitter of the commander at the remote control sensor of the player.
- Replace the battery in the remote if it is weak.

### The player does not play from the beginning when playing a disc.

- Resume Playback may be activated.  
→ Press ■ again or eject the disc.
- Depending on the DVD, a TOP menu or a DVD menu may automatically appear on the monitor during playback.  
→ Select the desired menu (page 19).
- Depending on the Video CD, the PBC menu display automatically appears on the monitor during playback.  
→ Select the desired menu (page 19).

### Playback stops automatically.

The disc may contain an auto pause signal. While playing such a disc, this player stops playback at the signal.

### You cannot perform certain functions, such as Stop or Search Playback.

With some discs, you cannot activate these functions.

### The language for the sound track cannot be changed during playback of a DVD.

- Multilingual tracks are not recorded on the DVD.
- Changing the language for the track is prohibited on the DVD.

### The subtitle language cannot be changed during playback of a DVD.

- Multilingual subtitles are not recorded on the DVD.
- Changing the language for the subtitles is prohibited on the DVD.

### The subtitles cannot be turned off during playback of a DVD.

Depending on the DVD, you may not be able to turn the subtitles off.

### The angles cannot be changed during playback of a DVD.

- Multi-angles are not recorded on the DVD.
- Change the angles at a scene recorded with multiple angles (page 18).
- Changing the angles is prohibited on the DVD.

### The player does not operate properly.

Static electricity, etc., may affect the player's operation.

→ Make sure that the player is completely turned off. Wait until the player cools off, then press the POWER button on the player until the POWER button lights up in green.



---

# Error display

## Error displays

The following indications will be displayed for about 8 seconds.

---

### POWER OFF OVERHEAT

The player may be overheated.

→ Allow the unit to cool off, then press

**(POWER)** on the player again.

---

### WRONG REGION

The region code of the DVD currently in the player does not conform to the player.

→ Make sure the region code of the DVD and the player (page 5).

---



The operation cannot be done.

---

# Language Code List

The language spellings conform to the ISO 639: 1988 (E/F) standard.

Code Language	Code Language	Code Language	Code Language
1027 Afar	1183 Irish	1347 Maori	1507 Samoan
1028 Abkhazian	1186 Scots Gaelic	1349 Macedonian	1508 Shona
1032 Afrikaans	1194 Galician	1350 Malayalam	1509 Somali
1039 Amharic	1196 Guarani	1352 Mongolian	1511 Albanian
1044 Arabic	1203 Gujarati	1353 Moldavian	1512 Serbian
1045 Assamese	1209 Hausa	1356 Marathi	1513 Siswati
1051 Aymara	1217 Hindi	1357 Malay	1514 Sesotho
1052 Azerbaijani	1226 Croatian	1358 Maltese	1515 Sundanese
1053 Bashkir	1229 Hungarian	1363 Burmese	1516 Swedish
1057 Byelorussian	1233 Armenian	1365 Nauru	1517 Swahili
1059 Bulgarian	1235 Interlingua	1369 Nepali	1521 Tamil
1060 Bihari	1239 Interlingue	1376 Dutch	1525 Telugu
1061 Bislama	1245 Inupiak	1379 Norwegian	1527 Tajik
1066 Bengali; Bangla	1248 Indonesian	1393 Occitan	1528 Thai
1067 Tibetan	1253 Icelandic	1403 (Afan)Oromo	1529 Tigrinya
1070 Breton	1254 Italian	1408 Oriya	1531 Turkmen
1079 Catalan	1257 Hebrew	1417 Punjabi	1532 Tagalog
1093 Corsican	1261 Japanese	1428 Polish	1534 Setswana
1097 Czech	1269 Yiddish	1435 Pashto; Pushto	1535 Tonga
1103 Welsh	1283 Javanese	1436 Portuguese	1538 Turkish
1105 Danish	1287 Georgian	1463 Quechua	1539 Tsonga
1109 German	1297 Kazakh	1481 Rhaeto-Romance	1540 Tatar
1130 Bhutani	1298 Greenlandic	1482 Kirundi	1543 Twi
1142 Greek	1299 Cambodian	1483 Romanian	1557 Ukrainian
1144 English	1300 Kannada	1489 Russian	1564 Urdu
1145 Esperanto	1301 Korean	1491 Kinyarwanda	1572 Uzbek
1149 Spanish	1305 Kashmiri	1495 Sanskrit	1581 Vietnamese
1150 Estonian	1307 Kurdish	1498 Sindhi	1587 Volapük
1151 Basque	1311 Kirghiz	1501 Sangho	1613 Wolof
1157 Persian	1313 Latin	1502 Serbo-Croatian	1632 Xhosa
1165 Finnish	1326 Lingala	1503 Singhalese	1665 Yoruba
1166 Fiji	1327 Laothian	1505 Slovak	1684 Chinese
1171 Faroese	1332 Lithuanian	1506 Slovenian	1697 Zulu
1174 French	1334 Latvian; Lettish		
1181 Frisian	1345 Malagasy		1703 Not specified



<http://www.sony.net/>

Sony Corporation Printed in Korea