

Portable CD/DVD Player

Operating Instructions _____ **US**

Manual de instrucciones _____ **ES**



DVP-FX970

WARNING

To reduce the risk of fire or electric shock, do not expose this apparatus to rain or moisture.

To avoid electrical shock, do not open the cabinet. Refer servicing to qualified personnel only.

The AC power cord must be changed only at a qualified service shop.

Batteries or batteries installed apparatus shall not be exposed to excessive heat such as sunshine, fire or the like.

CAUTION

The use of optical instruments with this product will increase eye hazard. As the laser beam used in this CD/DVD player is harmful to eyes, do not attempt to disassemble the cabinet. Refer servicing to qualified personnel only.

CAUTION CLASS 1M VISIBLE AND INVISIBLE LASER RADIATION WHEN OPEN AND INTERLOCKS DEFEATED. DO NOT VIEW DIRECTLY WITH OPTICAL INSTRUMENTS.

This label is located on the bottom of the unit.



 This symbol is intended to alert the user to the presence of “dangerous voltage” within the product’s enclosure that may be of sufficient magnitude to constitute a risk of electric shock to persons.



This symbol is intended to alert the user to the presence of important operating and maintenance (servicing) instructions in the literature accompanying the appliance.

Precautions

- Install this system so that the AC power cord can be unplugged from the wall socket immediately in the event of trouble.
- The player is not disconnected from the AC power source as long as it is connected to the wall outlet, even if the player itself has been turned off.
- To prevent fire or shock hazard, do not place objects filled with liquids, such as vases, on the apparatus.

For customers in the U.S.A. Owner's Record

The model and serial numbers are located at the bottom of the unit. Record the serial number in the space provided below. Refer to them whenever you call upon your Sony dealer regarding this product. Model No. DVP-FX970
Serial No. _____

CAUTION

You are cautioned that any changes or modifications not expressly approved in this manual could void your authority to operate this equipment.



This equipment has been tested and found to comply with the limits for a Class B digital device, pursuant to Part 15 of the FCC Rules. These limits are designed to provide reasonable protection against harmful interference in a residential installation. This equipment generates, uses, and can radiate radio frequency energy and, if not installed and used in accordance with the instructions, may cause harmful interference to radio communications.

However, there is no guarantee that interference will not occur in a particular installation. If this equipment does cause harmful interference to radio or television reception, which can be determined by turning the equipment off and on, the user is encouraged to try to correct the interference by one or more of the following measures:

- Reorient or relocate the receiving antenna.
- Increase the separation between the equipment and receiver.
- Connect the equipment into an outlet on a circuit different from that to which the receiver is connected.
- Consult the dealer or an experienced radio/TV technician for help.

IMPORTANT SAFETY INSTRUCTIONS

- 1) Read these instructions.
- 2) Keep these instructions.
- 3) Heed all warnings.
- 4) Follow all instructions.
- 5) Do not use this apparatus near water.
- 6) Clean only with dry cloth.
- 7) Do not block any ventilation openings. Install in accordance with the manufacturer's instructions.
- 8) Do not install near any heat sources such as radiators, heat registers, stoves, or other apparatus (including amplifiers) that produce heat.
- 9) Do not defeat the safety purpose of the polarized or grounding-type plug. A polarized plug has two blades with one wider than the other. A grounding type plug has two blades and a third grounding prong. The wide blade or the third prong are provided for your safety. If the provided plug does not fit into your

outlet, consult an electrician for replacement of the obsolete outlet.

- 10) Protect the power cord from being walked on or pinched particularly at plugs, convenience receptacles, and the point where they exit from the apparatus.
- 11) Only use attachments/accessories specified by the manufacturer.
- 12) Use only with the cart, stand, tripod, bracket, or table specified by the manufacturer, or sold with the apparatus. When a cart is used, use caution when moving the cart/apparatus combination to avoid injury from tip-over.



- 13) Unplug this apparatus during lightning storms or when unused for long periods of time.
- 14) Refer all servicing to qualified service personnel. Servicing is required when the apparatus has been damaged in any way, such as power-supply cord or plug is damaged, liquid has been spilled or objects have fallen into the apparatus, the apparatus has been exposed to rain or moisture, does not operate normally, or has been dropped.

Do not take apart or remodel the player. Doing so can result in electric shock. Consult your nearest Sony dealer or Sony Service Center for exchange of rechargeable batteries, internal checks or repair.

IMPORTANT NOTICE

Caution: This player is capable of holding a still video image or on-screen display image on your television screen indefinitely. If you leave the still video image or on-screen display image on your TV for an extended period of time you risk permanent damage to your television screen. Plasma display panel televisions and projection televisions are susceptible to this.

If you have any questions or problems concerning your player, please consult your nearest Sony dealer.

Copyrights and trademarks

- Manufactured under license from Dolby Laboratories. Dolby and the double-D symbol are trademarks of Dolby Laboratories.
- “DVD+RW,” “DVD-RW,” “DVD+R,” “DVD+R DL,” “DVD-R,” “DVD VIDEO,” and “CD” logos are trademarks.
- MPEG Layer-3 audio coding technology and patents licensed from Fraunhofer IIS and Thomson.
- THIS PRODUCT IS LICENSED UNDER THE MPEG-4 VISUAL PATENT PORTFOLIO LICENSE FOR THE PERSONAL AND NONCOMMERCIAL USE OF A CONSUMER FOR DECODING VIDEO IN COMPLIANCE WITH THE MPEG-4 VISUAL STANDARD (“MPEG-4 VIDEO”) THAT WAS ENCODED BY A CONSUMER ENGAGED IN A PERSONAL AND NONCOMMERCIAL ACTIVITY AND/OR WAS OBTAINED FROM A VIDEO PROVIDER LICENSED BY

MPEG LA TO PROVIDE MPEG-4 VIDEO. NO LICENSE IS GRANTED OR SHALL BE IMPLIED FOR ANY OTHER USE. ADDITIONAL INFORMATION INCLUDING THAT RELATING TO PROMOTIONAL, INTERNAL AND COMMERCIAL USES AND LICENSING MAY BE OBTAINED FROM MPEG LA, LLC. SEE [HTTP://WWW.MPEGLA.COM](http://WWW.MPEGLA.COM)

About this manual



- In this manual, “disc” is used as a general reference for the DVDs or CDs unless otherwise specified by the text or illustrations.
- Icons, such as , listed at the top of each explanation indicate what kind of media can be used with the function being explained. For details, see “Playable Media” (page 23).
- NEED-to-know information (to prevent incorrect operation) is listed under the  icon. NICE-to-know information (tips and other useful information) is listed under the .

Table of Contents

WARNING	2
Guide to Parts and Controls	5
<hr/>	
Preparations	8
Checking the Accessories	8
Charging the Battery	8
Using the Car Battery Adaptor	9
Connecting to Other Equipment	10
<hr/>	
Playback	11
Playing Discs	11
Playing MP3, JPEG, and Video Files	13
Adjusting the Picture Size and Quality	15
<hr/>	
Settings and Adjustments	16
Using the Setup Display	16
<hr/>	
Additional Information	19
Troubleshooting	19
Precautions	21
Playable Media	23
Specifications	25
Index	26

Guide to Parts and Controls

The available functions of the player and remote differ depending on the disc or the situation.

Player

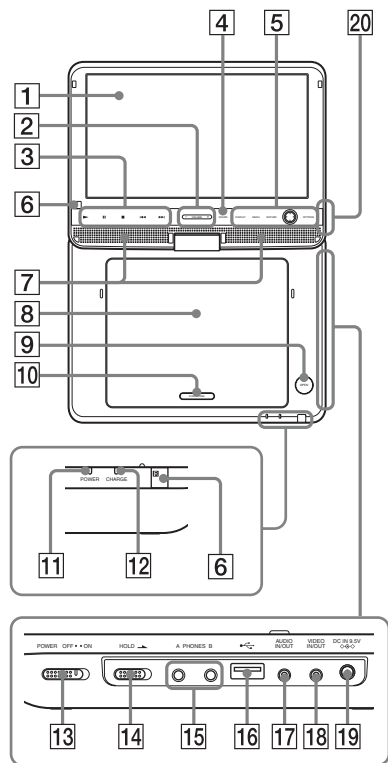

The VOL+ and ► (play) buttons have a tactile dot. Use the tactile dot as a reference when operating the player.

1 LCD panel (page 7)

2 VOL (sound volume) +/-

Adjusts the volume.

3 ► (play) (page 11)

Starts or re-starts playback.

■ (pause) (page 11)

Pauses or re-starts playback.

■ (stop) (page 11)

Stops playback.

◀◀/▶▶ (previous/next)

Skips to the previous/next chapter, track, or file.

4 SOUND

Switches among 4 different sound modes each time pressed.

This function is available only for the sound output from the player's speaker.

5 DISPLAY

Displays the playback information.

- When playing a DVD, changes the playback mode (page 12).

MENU

Displays the DVD VIDEO's menu.

- When playing a CD or VIDEO CD (PBC function is off), switches to Repeat Play (page 12) or Random Play.
- When playing a JPEG file, plays a slideshow (page 14).

RETURN

Returns to the previous display.

←/↑/↓/→

Moves the highlight to select a displayed item.

- \leftarrow/\rightarrow on the player works the same as \leftarrow/\rightarrow on the remote.

Center button (ENTER)

Enters the selected item.

- ENTER on the player works the same as \blacktriangleright .

OPTIONS

Displays the menu for adjusting the LCD screen (page 15) and using the setup display (page 16).

6 (remote sensor)

7 Speaker

8 Disc Lid (page 11)

9 OPEN button (page 11)

Opens the disc lid.

10 PUSH CLOSE (page 11)

Closes the disc lid.

11 POWER indicator

12 CHARGE indicator (page 8)

13 POWER switch (page 11)

Turns the player on or off.

14 HOLD switch

To avoid accidental button operation of the player, set the HOLD switch to the direction of the arrow.

All the buttons on the player are locked, while the buttons on the remote remain operable.

15 PHONES (headphone) jack A, B

16 USB jack (type A) (page 14)

Connect a USB device to this jack.

17 AUDIO IN/OUT jack (page 10)

18 VIDEO IN/OUT jack (page 10)

19 DC IN 9.5V jack (page 8, 9)

Connect the AC adaptor or car battery adaptor.

20 INPUT SELECT button (page 10)

Each time you press the button, the LCD screen image switches as follows:

- Disc (default)
- USB (page 14)
- Line In (page 10)

Remote

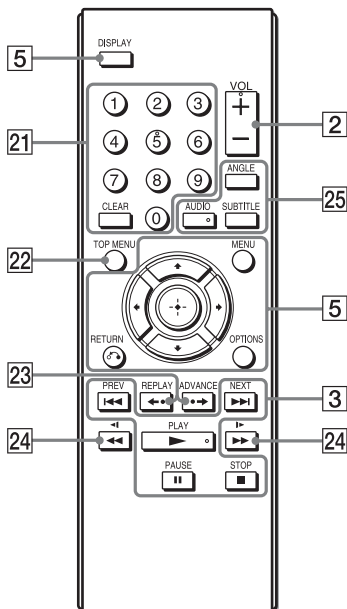

The VOL +, number 5, \blacktriangleright and AUDIO buttons have a tactile dot. Use the tactile

dot as a reference when operating the player.

21 Number buttons

Enters the title/chapter numbers, etc.

CLEAR button

Clears the entry field.

22 TOP MENU button

Displays the DVD VIDEO's top menu.

- When playing a DVD VR, switches between "Original" and "Play List."

23 ◀◀-REPLAY/▶▶-ADVANCE buttons

Replays the scene/briefly fast forward the current scene (DVD only).

24 ◀◀◀◀/▶▶▶▶ (scan/slow) buttons

- Fast reverses/fast forwards when pressed during playback. Press repeatedly to change the speed.
- Slow reverses/slow forwards when pressed during pause. Press repeatedly to change the speed. (Slow reverse play is available for DVD only. Slow forward play is available for DVD, VIDEO CD and video files.)

25 ANGLE button

Changes the angles recorded on a DVD VIDEO.

AUDIO button

Changes the audio signal each time pressed.

- When playing a DVD VIDEO, switches the recorded language.
- When playing a CD or VIDEO CD, switches between stereo and monaural.

SUBTITLE button

Changes the subtitles recorded on a DVD VIDEO each time pressed.

Rotating and Folding Down the LCD Panel

Open the LCD panel to the vertical position and rotate it 180 degrees clockwise slowly.

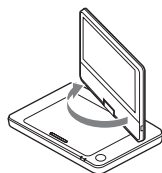

After rotating the LCD panel 180 degrees clockwise, push the LCD panel down onto the main body of the player. In this position the panel is facing up.

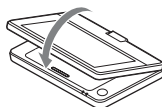

To return the LCD panel to its original position

Open the LCD panel to the vertical position and rotate it counter-clockwise slowly.



Return the LCD panel to its original positions after use, so the LCD panel will not be damaged by sudden shocks or rough treatment.

Checking the Accessories

Check that you have the following items:

- AC adaptor (1)
- Car battery adaptor (1)
- Audio/video cable (mini plug × 2 ↔ phono plug × 3) (1)
- Remote commander (remote) (1)
- Size AA (R6) batteries (2)

Preparing the remote

Insert two Size AA (R6) batteries by matching the ⊕ and ⊖ ends on the batteries to the markings inside the compartment.

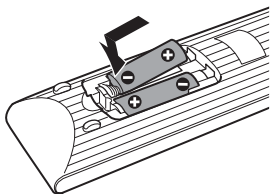

Charging the Battery

Charge the rechargeable battery before using the player for the first time, or when the battery is depleted.

1 Connect the AC adaptor.

When charging begins, the CHARGE indicator lights up in orange.

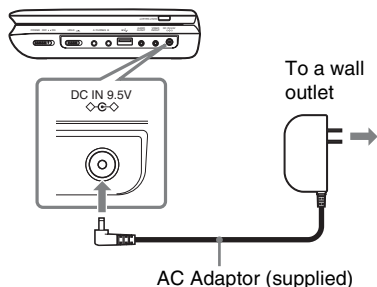

When charging ends, the CHARGE indicator lights off.
Disconnect the AC adaptor.



Charging takes longer if the player is turned on. When you only want to charge the battery, turn off the player.



Charge the battery in an ambient temperature of between 5 °C (41 °F) to 35 °C (95 °F).

Charging time and playing time

Charging time: approx. 6 hours

Playing time: approx. 6 hours

Times indicated are under the following conditions:

- Charging time
 - moderate temperature (20 °C (68 °F))
 - power-off
- Playing time
 - moderate temperature (20 °C (68 °F))
 - headphone use
 - backlight set to minimum

Depending on the ambient temperature or rechargeable battery condition, charging time may be longer, or playing time may be reduced.

To check the battery level

When the player is stopped, the battery indicator is displayed. When the battery is empty,  is displayed or the CHARGE indicator flashes.



Using the Car Battery Adaptor

The car battery adaptor (supplied) is for a 12 V car battery, negative earth (do not use it with a 24 V car battery, positive earth).

1 Connect the car battery adaptor.

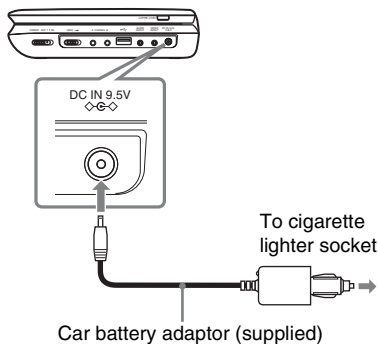

After using the player in a car

Disconnect the car battery adaptor from a cigarette lighter socket.



- The driver should not connect or disconnect the car battery adaptor while driving.
- Arrange the cord so as not to interfere with the driver. Also, do not place the LCD panel where the driver can watch.
- Clean the cigarette lighter socket. If it is dirty, it may cause contact failure or malfunction.
- Use the car battery adaptor with the car engine running. If it is used with the car engine off, the car battery may become depleted.
- Do not leave the player or accessories in the car.

Connecting to Other Equipment

By connecting the player to your TV or other equipment, you can increase your viewing options.



- Refer to the instructions supplied with the equipment to be connected.
- Before connecting, turn off the player and the equipment to be connected, then unplug from their wall sockets.

Enjoying images on a connected TV

- 1 Connect the player to your TV or monitor using the audio/video cable (supplied).

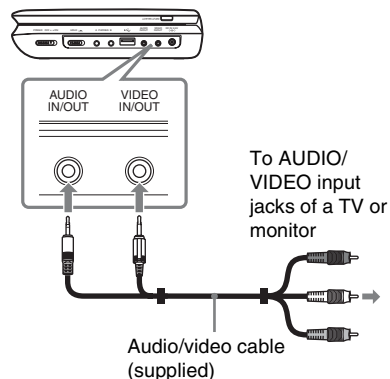

The player can connect to an AV amplifier in the same way as a TV.

Enjoying images on other equipment

- 1 Connect the player to your video player or camcorder using the audio/video cable (supplied).

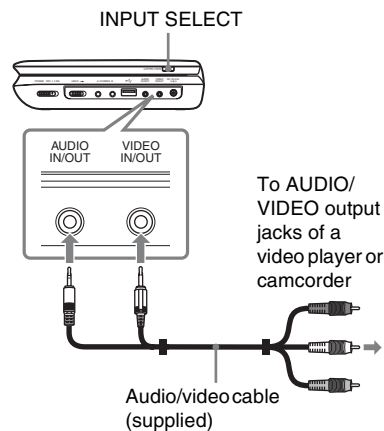

- 2 Turn on the player and press **INPUT SELECT** repeatedly to select "Line In."

Playing Discs

DVDVideo DVDVR VCD CD

DATA

Depending on the disc, some operations may be different or restricted. Refer to the operating instructions supplied with the disc.

Charge the battery in advance or connect the AC adaptor.

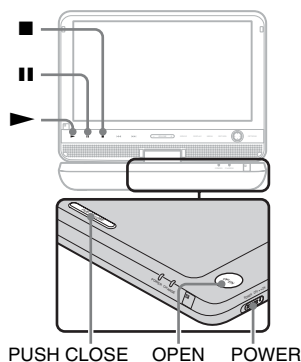

- 1** Open the LCD panel.
- 2** Slide the **POWER** switch to "ON."
- 3** Press **OPEN** to open the disc lid.

4 Insert the disc.

Place with the playback side down and push gently until it clicks. Do not touch the lens surface.

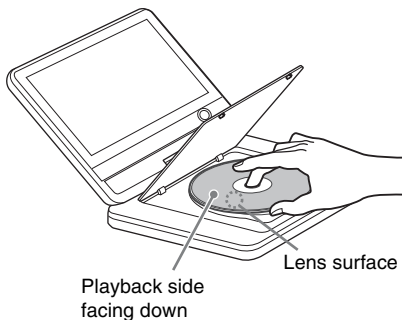

5 Push the **PUSH CLOSE** on the disc lid to shut the disc lid.

6 Press **▶**.

The player starts playback. Depending on the disc, a menu may appear. Press **←/↑/↓/→** to select the item, and press **ENTER**.



When you change the LCD picture size, press **OPTIONS** to select "LCD Mode" (page 15).



- Discs created on DVD recorders must be correctly finalized to play on the player. For more information about finalizing, refer to the operating instructions supplied with the DVD recorder.
- The disc may be still spinning when the disc lid is opened. Wait until the spinning stops before removing the disc.

Notes on the screen saver

- A screen saver image appears when you leave the player in pause or stop mode without operation for more than 15 minutes. The image disappears when you press ►. For the setup of “Screen Saver,” see page 17.
- The player goes to standby, 15 minutes after starting the screen saver function. Press ► to come out of standby mode.

To resume playback from the point where you stopped the disc (Resume Play) **DVDVideo** **DVDVr** **VCD** **CD**

When you press ► again after you stop playback, the player starts playback from the point when you pressed ■.



- To play from the beginning of the disc, press ■ twice, and press ►.
- When turning power on again after power off, resume play starts automatically.



- Depending on the stop point, Resume play may not start from exactly the same point.
- The resume point is cleared when:
 - you open the disc lid.
 - you press INPUT SELECT.

To play repeatedly (Repeat Play)

DVDVideo **VCD** **CD**

- When playing a DVD VIDEO, press DISPLAY to select “Repeat” (page 13).
- When playing a CD or VIDEO CD (PBC function is off), press MENU repeatedly (page 5).

To play VIDEO CDs with PBC Functions (PBC Playback) **VCD**

PBC (Playback Control) allows you to play VIDEO CDs interactively using a menu. When you start playing a VIDEO CD with PBC functions, the menu appears. Select an item using the number buttons on the remote, and press ENTER. Then, follow the instructions in the menu (press ► when “Press SELECT.” appears).

Using the Playback Information Display

DVDVideo **DVDVr**

While playing a DVD, you can check the playback information. The playback information display also allows you to set a title/chapter or change sound/subtitle, and so on.

When you enter the numbers, use the remote.

1 Press DISPLAY while playing a DVD.

Example: When playing a DVD VIDEO

Items

Menu	
Title	02/07 *1
Chapter	03/20
Audio	01 5.1CH English
Subtitle	01 English
▶ Title Elapsed 00:12:01	

2 Select and adjust each of the following items by pressing ↑/↓ and ENTER.

- Title: Select the title number.*2
- Chapter: Select the chapter number.*2
- Audio: Select the sound.
- Subtitle: Select the subtitle.
- Angle: Select the angle.

- **T.Time:** Time appears while playing a title. “00:00:00” will appear by pressing ENTER. Enter the desired time code number.
- **C.Time:** Time appears while playing a chapter. “00:00:00” will appear by pressing ENTER. Enter the desired time code number.
- **Repeat:** Select the Repeat mode.
- **A-B Repeat:** Select “Set” by pressing \uparrow/\downarrow , and press ENTER. Select point A and point B by pressing ENTER.
- **Time Disp.:** Select the time information displayed.

*1 When a DVD (VR mode) is played, “PL” (playlist) or “ORG” (original) is displayed next to the title number.

*2 To select the number, use \uparrow/\downarrow or the number buttons.

To turn off the display

Press DISPLAY or RETURN.



Depending on the disc, you may not be able to see some items.

Playing MP3, JPEG, and Video Files **DATA**

You can play MP3, JPEG, and video files. For details on playable files, see “Playable Media” (page 23).

When you set a DATA media, a list of albums appears. Depending on the disc, playback starts automatically.

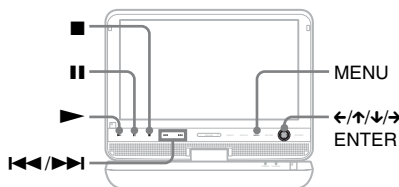

1 Press \uparrow/\downarrow to select the album, and press ENTER.

Example: The list of MP3 files

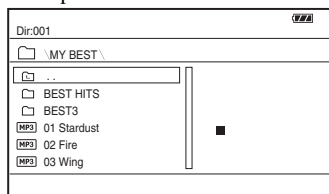

- To go to the next or previous page, press \blacktriangleright or \blacktriangleleft .
- To return to the list of albums, press \uparrow/\downarrow to select \square and press ENTER.

2 Press \uparrow/\downarrow to select the file, and press ENTER or \blacktriangleright .

Playback starts from the selected file.

Selecting a JPEG file

To rotate a JPEG image

Press ←/↑/↓/→ while viewing the image file. Rotate every file.

→: Rotates the image 90 degrees clockwise.

←: Rotates the image 90 degrees counter clockwise.

↑: Reverses the image vertically (up and down).

↓: Reverses the image horizontally (left and right).

To display the list of thumbnails

Press MENU.

The image files in the album appear in 12 sub-screens.

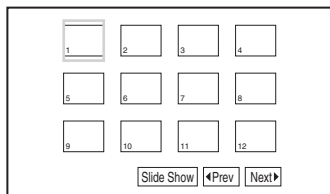

- To go to the previous or next list of thumbnails, select “◀Prev” or “Next▶” at the bottom of the screen, and press ENTER.
- To exit the list of thumbnails, press MENU.

Playing a Slide Show

1 Press MENU.

The list of thumbnails appears.

2 Press ←/↑/↓/→ to select “Slide Show” at the bottom of the screen, and press ENTER.

A slideshow starts.

Playing data on a USB device

You can play back DATA files on a USB device.

1 Press INPUT SELECT repeatedly to select “USB.”

2 Connect a USB device to the USB jack.

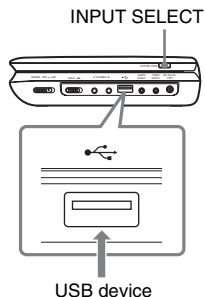

To disconnect a USB device

1 Press INPUT SELECT to deselect “USB.”

2 Disconnect the USB device.

About supported Sony USB devices

The following Sony USB flash drive “Micro Vault” and Digital Camera (released after 2008) are supported: USM-J/B series, USM-L series, and USM-LX series, DSC-T series, DSC-W series, DSC-H series, DSC-S series, and DSLR-A series.



- Do not disconnect the USB device while its access indicator is flashing. Doing so may cause data corruption or loss of data.
- USB devices which can connect to the player are flash memory and digital still camera. Other devices (USB hub, etc.) cannot be connected. When an unsupported device is connected, an error message appears.

Adjusting the Picture Size and Quality

DVDVideo DVDVR VCD DATA

You can adjust the picture displayed on the LCD screen.

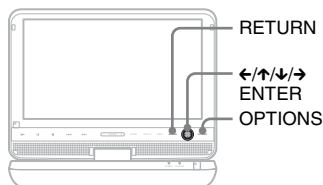

- 1 Press OPTIONS.**
- 2 Press \uparrow/\downarrow to select “LCD Mode” and press ENTER.**
- 3 Select and adjust each of the following items by pressing \leftarrow/\rightarrow and ENTER.**
 - LCD Aspect: Change the picture size.
 - Backlight: Adjust the brightness.
 - Contrast: Adjust the difference between light and dark areas.
 - Hue: Adjust the red and green color balance.
 - Color: Adjust the richness of colors.
 - Default: Return all settings to the factory defaults.

To turn off the menu display

Press OPTIONS or RETURN.



Depending on the disc, the screen size you can select differs.

Using the Setup Display

Some discs have stored playback settings, which take priority.

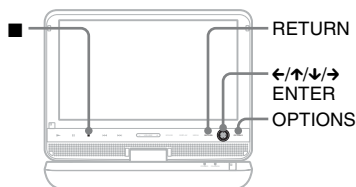

1 Press **OPTIONS** when the player is in stop mode.

During Resume Play, you cannot use the setup display. Press ■ twice and press **OPTIONS**.

2 Press **↑/↓** to select “Setup,” and press **ENTER**.

3 Press **↑/↓** to select the setup category and press **ENTER**.

- 🗑️: General Setup (page 16)
Makes the player-related settings.
- 🔊: Audio Setup (page 17)
Makes the audio settings according to playback conditions.
- 🗨️: Language Setup (page 17)
Makes the language settings for the on-screen display or sound track.
- 🔒: Parental Control (page 18)
Sets the parental control limit.

4 Select and adjust each of the following items by pressing **↑/↓** and **ENTER**.

To turn off the setup display



Press **OPTIONS** or **RETURN**.

🗑️ General Setup

The default settings are underlined.

◆ TV Display (DVD only)

Selects the aspect ratio of the connected TV.

<p>4:3 <u>Pan Scan</u></p>	<p>Select this when you connect a 4:3 screen TV. Automatically displays a wide picture on the entire screen and cuts off the portions that do not fit.</p> 
<p>4:3 <u>Letter Box</u></p>	<p>Select this when you connect a 4:3 screen TV. Displays a wide picture with bands on the upper and lower portions of the screen.</p> 
<p><u>16:9</u></p>	<p>Select this when you connect a wide-screen TV or a TV with a wide mode function.</p> 

⚠️ Depending on the disc, “4:3 Letter Box” may be selected automatically instead of “4:3 Pan Scan” or vice versa.

◆ Angle Mark (DVD VIDEO only)

Displays the angle mark when you can change the viewing angles during playback of DVDs recorded with multi-angles.

<u>On</u>	Displays the angle mark.
Off	Hides the angle mark.

◆ Screen Saver

The screen saver image appears when you leave the player in pause or stop mode for 15 minutes. The screen saver will help prevent your display equipment from becoming damaged (ghosting). Press **▶** to turn off the screen saver.

<u>On</u>	Activates the screen saver function.
Off	Deactivates the screen saver function.

◆ PBC

You can enjoy playing interactive programs using the PBC (Playback Control) function of a VIDEO CD if available (page 12).

<u>On</u>	Activates the PBC function.
Off	Deactivates the PBC function.

◆ Default

Each function returns to its original factory settings. Note that all of your settings will be lost.

🔊) Audio Setup

The default setting is underlined.

◆ Audio DRC (Dynamic Range Control) (DVD only)

Makes low sounds clear when the volume is turned down when playing a DVD that conforms to “Audio DRC.”

<u>On</u>	Activates the Audio DRC function.
Off	Deactivates the Audio DRC function.

Ⓐ Language Setup**◆ OSD (On-Screen Display)**

Switches the display language on the screen.

◆ Disc Menu (DVD VIDEO only)

Switches the language for the disc’s menu. When you select “Original,” the language given priority in the disc is selected.

◆ Subtitle (DVD VIDEO only)

Switches the subtitle language. When you select “Off,” no subtitle is displayed.

◆ Audio (DVD VIDEO only)

Switches the language of the sound track. When you select “Original,” the language given priority in the disc is selected.



If you select a language in “Disc Menu,” “Subtitle,” or “Audio” that is not recorded on the disc, one of the recorded languages will be automatically selected.

Parental Control

You can limit playback of a DVD that has the parental control function.

When you operate this setting, use the remote.

◆ Password (DVD VIDEO only)

Enter or change a password. Set the password for the parental control function. Enter your 4-digit password using the number buttons.

To change the password

- 1 Press **↑/↓** to select “Password,” and press ENTER.
- 2 Check “Change” is selected and press ENTER.
- 3 Enter your current password in “Old Password,” your new password in “New Password” and “Verify Password,” and press ENTER.

If you make a mistake entering your password

Press CLEAR, or press **←** to return one by one before pressing ENTER in step 3, and re-enter the password.

If you forget your password

Enter “1369” in “Old Password,” and enter your new password in “New Password” and “Verify Password.”

◆ Parental Control (DVD VIDEO only)

Set the limitation level. The lower the value, the stricter the limitation.

To set the parental control, you need to set the password first.

To set the parental control (limited playback)

- 1 Press **↑/↓** to select “Parental Control,” and press ENTER.
- 2 Press **↑/↓** to select the limitation level, and press ENTER.
- 3 Enter your password, and press ENTER.

To play a disc for which Parental Control is set

Insert the disc and press **▶**. The display for entering your password appears. Enter your password using the number buttons, and press ENTER.

Troubleshooting

If you experience any of the following difficulties while using the player, use this troubleshooting guide to help remedy the problem before requesting repairs. Should any problem persist, consult your nearest Sony dealer.

Power

The power is not turned on.

- ➔ Check that the AC adaptor is connected securely (page 8).
- ➔ Check that the rechargeable battery is sufficiently charged (page 9).

The battery cannot be charged or charging time is long

- ➔ If the CAHRGE indicator flashes while the AC adaptor is connected, the ambient temperature may not be appropriate. Charge the battery in an ambient temperature of between 5 °C (41 °F) to 35 °C (95 °F).
- ➔ Charging takes longer if the player is turned on. Before charging, turn off the player.
- ➔ If you have not used the player for more than a year, the battery may have been deteriorated. Consult your nearest Sony dealer.

Picture

The black points appear and the red, blue, green points remain on the LCD.

- ➔ This is a structural property of the LCD and not malfunction.

Sound

There is no sound or the sound is not output correctly.

- ➔ The player is in pause mode or in slow play mode.
- ➔ The player is in fast forward or fast reverse mode.
- ➔ The sound mode is fixed to “Standard” when an audio cable is connected to the AUDIO IN/OUT jack. Disconnect the audio cable from the jack for stand-alone use of this player.

Operation

Nothing happens when buttons are pressed.

- ➔ The HOLD switch is set in the direction of the arrow (page 6).

The disc does not play.

- ➔ If the disc is turned over, a “No Disc” or “Cannot play this disc.” message appears. Insert the disc with the playback side facing down (page 11).
- ➔ The disc is not set until it clicks (page 11).
- ➔ The disc is dirty or flawed (page 22).
- ➔ The disc that cannot be played is inserted. Check the region code matches the player, and that the disc has been finalized (page 23).
- ➔ When “USB” or “Line In” is displayed, press INPUT SELECT repeatedly to select the disc mode (page 6).
- ➔ Parental Control has been set. Change the setting (page 18).
- ➔ Moisture has condensed inside the player (page 21).

The disc does not start playing from the beginning.

- ➔ Repeat Play (page 12) or Random Play (page 5) is selected.
- ➔ Resume play has taken effect (page 12).

- ➔ The Playlist of the created disc is automatically played. To play original titles, press ■ twice, and press TOP MENU to set “Original.”

“Ⓞ” appears and the player does not function according to the button.

- ➔ Depending on the disc, you may not be able to perform certain operations. Refer to the operating instructions supplied with the disc.

“Copyright Lock” appears and the screen turns blue when playing a DVD (VR mode) disc.

- ➔ When images that contain copy protection signals are played, a blue screen and the message may appear instead of the images (page 23).

⏪/⏩ does not work on menu display.

- ➔ Depending on the disc, you may not be able to use ⏪/⏩ on the player for the disc menu. In this case, use ⏪/⏩ on the remote.

The remote does not function.

- ➔ Batteries in the remote are weak.
- ➔ The remote is not pointed at the remote sensor [R] on the player.
- ➔ Direct sunlight or strong illumination is striking the remote sensor.

The MP3, JPEG, or video file cannot be played (page 24).

- ➔ The file format does not conform.
- ➔ The extension does not conform.
- ➔ The file is damaged.
- ➔ The file size is too large.
- ➔ When the selected file is not supported, “Data Error” appears and the file will not be played.
- ➔ Because of the compression technology used for video files, playback may take time to start.

The player does not operate properly or the power does not turn off.

- ➔ When static electricity, etc., causes the player to operate abnormally, set the POWER switch to “OFF” and disconnect the adaptor and leave for 30 seconds.

Hookup

There is no picture or sound on the connected equipment (TV or monitor).

- ➔ Re-connect the connecting cable securely (page 10).
- ➔ The connecting cable is damaged.
- ➔ Check the setting of a connected TV or amplifier.

There is no picture or sound from a connected equipment (video player or camcorder).

- ➔ Press INPUT SELECT repeatedly to select “Line In” (page 10).

USB

The player does not recognize a USB device connected to the player.

- ➔ Re-connect the USB device securely (page 14).
- ➔ The USB device is damaged.
- ➔ Press INPUT SELECT repeatedly to select “USB” (page 14).

Precautions

Road safety

Do not use the monitor unit and headphones while driving, cycling, or operating any motorized vehicle. Doing so may create a traffic hazard and is illegal in some areas. It can also be potentially dangerous to play your headsets at high volume while walking, especially at pedestrian crossings. You should exercise extreme caution or discontinue use in potentially hazardous situations.

On safety

Should any solid object or liquid fall into the cabinet, unplug the player and have it checked by qualified personnel before operating it any further.

On power sources

- If you are not going to use the player for a long time, be sure to disconnect the player from the wall outlet. To disconnect the AC adaptor, grasp the plug itself; never pull the cord.
- Do not touch the AC adaptor with wet hands. Doing so may cause shock hazard.
- Use a commercially available AC plug adaptor, if necessary, depending on the design of the wall outlet.

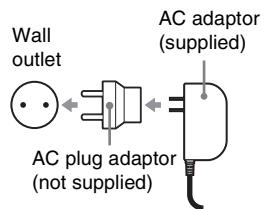

- Do not connect the AC adaptor to a traveler's electric transformer, which may generate heat and cause a malfunction.

On temperature increases

Heat may build up inside the player during charging or if it is being used for a long time. This is not a malfunction.

On placement

- Do not place the player in a confined space such as a bookshelf or similar unit.
- Do not cover the ventilation of the player with newspapers, tablecloths, curtains, etc. And do not place the player on a soft surface, such as a rug.
- Do not place the player and adaptors in a location near heat sources, or in a place subject to direct sunlight, excessive dust, sand, moisture, rain, or mechanical shock, or in a car with its windows closed.
- Do not place the player in an inclined position. It is designed to be operated in a horizontal position only.
- Keep the player and discs away from equipment with strong magnet, such as microwave ovens, or large loudspeakers.
- Do not drop or apply strong shock. Do not place heavy objects on the player and accessories.

On operation

- If the player is brought directly from a cold to a warm location, or is placed in a very damp room, moisture may condense on the lenses inside the player. Should this occur, the player may not operate properly. In this case, remove the disc and leave the player for about half an hour until the moisture evaporates. Wipe off moisture attached to the LCD surface with tissue etc. Turn on the power again later.
- Keep the lens on the player clean and do not touch it. Touching the lens may damage the lens and cause the player to malfunction. Leave the disc lid closed except when you insert or remove discs.

On Liquid Crystal Display

- Although manufactured with high precision technology, the LCD may occasionally display dots of various colors. That is not a malfunction.
- Do not place or drop any object onto the LCD surface. Also, do not apply pressure from hands or elbows.
- Do not damage the LCD surface with a sharp edged tool.

On rechargeable battery

- Because of the battery's limited life, its capacity gradually deteriorates over time and repeated use. Exchange an old one with a new one when the battery holds about only half the normal period.
- To prevent battery deterioration, charge the battery at least once every half a year or every year.
- Certain countries may regulate disposal of the battery used to power this product. Please consult with your local authority.

On AC adaptor and car battery adaptor

- Use the supplied adaptors for the player, as other adaptors may cause a malfunction.
- Do not disassemble or reverse-engineer.
- Do not touch the metal parts, as it may cause a short and damage the adaptors, especially if touched by other metal objects.

On adjusting volume

Do not turn up the volume while listening to a section with very low level inputs or no audio signals. If you do, the speakers may be damaged when a peak level section is played.

On headphones

- Preventing hearing damage: Avoid using headphones at high volumes. Hearing experts advice against continuous, loud, and extended play. If you experience a

ringing in your ears, reduce the volume or discontinue use.

- Showing consideration for others: Keep the volume at a moderate level. This will allow you to hear outside sounds and still be considerate to the people around you.













On cleaning

- Clean the cabinet, panel, and controls with a soft cloth slightly moistened with a mild detergent solution. Do not use any type of abrasive pad, scouring powder or solvent such as alcohol or benzine.
- Wipe the LCD surface with the soft dry cloth lightly. To prevent dirt buildup, wipe it frequently. Do not wipe the LCD surface with a wet cloth. If water enters, a malfunction may result.
- If picture/sound is distorted, the lens may be covered with dust. In this case, use a commercially-available blower brush for camera lenses to clean the lens. Avoid touching the lens directly during cleaning. Do not use cleaning discs or disc/lens cleaners.

Notes About the Discs

- To keep the disc clean, handle the disc by its edge. Do not touch the surface.
- Do not use the following discs:
 - A disc that has a non-standard shape (e.g., card, heart).
 - A disc with a label or sticker on it.
 - A disc that has cellophane tape or sticker adhesive on it.

Playable Media

Type	Disc Logo	Icon	Characteristics
DVD	     		<ul style="list-style-type: none"> • Commercial DVD • DVD+RWs/DVD+Rs/ DVD+R DLs in +VR mode • DVD-RWs/DVD-Rs/ DVD-R DLs in video mode
			DVD-RWs/DVD-Rs/DVD-R DLs in VR (Video Recording) mode
CD			<ul style="list-style-type: none"> • Music CDs • CD-Rs/CD-RWs in music CD format
			<ul style="list-style-type: none"> • VIDEO CDs • CD-Rs/CD-RWs in video CD format
DATA disc or USB	—		DATA CD/DATA DVD or USB devices containing MP3, JPEG, or video files.



Notes about recordable media

Some recordable media cannot be played on the player due to the recording quality or physical condition of the media, or the characteristics of the recording device and authoring software.

The disc will not play if it has not been correctly finalized. For more information, refer to the operating instructions for the recording device. Note that some playback functions may not work with some DVD+RWs/+Rs/+R DLs, even if they have been correctly finalized. In this case, view the disc by normal playback.

For player that cannot play images that contain a copy protection only

Images in DVD (VR mode) with CPRM* protection may not be played if they contain a copy protection signal. "Copyright Lock" appears.

* CPRM (Content Protection for Recordable Media) is a coding technology that protects the copyright of images.

Notes on MP3, JPEG, and video files

The player can play the following files:

- MP3 files with the extension “.mp3”^{*1}.
- JPEG files with the extension “.jpg”^{*2}.
- JPEG image files that conform to the DCF (Design rule for Camera File system) image file format.
- MPEG-4 video files (simple profile) with the extension “.mp4”^{*3}.
- DATA CDs must be recorded according to ISO 9660 Level 1, or its extended format, Joliet.
- DATA DVDs must be recorded according to UDF (Universal Disk Format).

^{*1} Files in mp3PRO format cannot be played.

^{*2} Files with the extension “.jpe” or “.jpeg” can be played by changing the extension to “.jpg.”

^{*3} Files with copyright protection (Digital Right Management) cannot be played. Files in MPEG-4 AVC format cannot be played.



- To play a complex hierarchy of folders may take some time. Create albums as follows:
 - The number of hierarchies in the media should be no more than two.
 - The number of albums in the media should be 50 or less.
 - The number of files in one album should be 100 or less.
 - The total number of albums and files in the media should be 600 or less.
- The player plays the files in an album in the order the media was recorded.



- The player will play any file in the above table, even if the file format differs. Playing such data may generate noise that can result in speaker damage.
- Some DATA discs created in Packet Write format cannot be played.
- Some DATA discs created in multiple sessions may not be playable.
- Some JPEG files cannot be played.

- The player cannot play the JPEG file that is larger than 3078 (width) x 2048 (height) in normal mode, or larger than 2000 (width) x 1200 (height) in progressive JPEG. (Some progressive JPEG files cannot be displayed even if the size is within this specified capacity.)
- The player may not play a combination of two or more video files.
- The player cannot play a video file of size more than 720 (width) x 576 (height)/2 GB.
- The player may not play certain video files that are longer than 3 hours.
- Depending on the video file, normal playback may not be possible. The picture may be unclear, playback may not appear smooth, the sound may skip, etc. You are recommended to create the file at a lower bit rate. If the sound is still noisy, check the audio format. (MPEG-4 video files should be AAC LC.) Note, however, the player does not conform to WMA (Windows Media Audio) format.
- The player may not play the high bit rate video file on the DATA CD smoothly. It is recommended to play the high bit rate video file using the DATA DVD.
- The player can display a file or album name up to 14 characters. Special character appears as “*.”
- The player can display only the currently playing album name. Any album located on the upper layer is displayed as “\.”
- Playback information of some files may not be displayed correctly.

Notes on commercial discs

Region code

It is the system that is used to protect copyrights. The region code is shown on the DVD VIDEO packages according to the region of sale. DVD VIDEOS labeled “ALL” or “1” will play on the player.



DVD and VIDEO CD playback operations

Some playback operations of DVDs and VIDEO CDs may be intentionally set by software producers. Since the player plays DVDs and VIDEO CDs according to the disc contents the software producers designed, some playback features may not be available. Also, refer to the instructions supplied with the DVDs and VIDEO CDs.

Notes on discs

This product is designed to playback discs that conform to the Compact Disc (CD) standard.

DualDiscs and some music discs encoded with copyright protection technologies do not conform to the Compact Disc (CD) standard. Therefore, these discs may not be compatible with this product.

Specifications

System

Laser: Semiconductor laser

Signal format system: NTSC

Inputs/Outputs

VIDEO IN/OUT (video input/output):

Minijack

AUDIO IN/OUT (audio input/output):

Stereo minijack

PHONES (headphones) A/B:

Stereo minijack

USB: USB jack Type A (For connecting USB memory)

Liquid Crystal Display

Panel size: 9 inches wide (diagonal)

Driving system: TFT active matrix

Resolution: 800 × 480

General

Power requirements:

DC 9.5 V 1.2 A (AC Adaptor/Car battery adaptor)

Power consumption (DVD VIDEO Playback):

6.5 W (when used with a headphone)

Dimensions (approx.):

233 × 44 × 173 mm (9 1/4 × 1 3/4 × 6 7/8 inches) (width/height/depth) incl. projecting parts

Mass (approx.): 1.05 kg (2.31 lbs)

Operating temperature: 5 °C to 35 °C (41 °F to 95 °F)

Operating humidity: 25% to 80%

AC Adaptor: 110-240 V AC, 50/60 Hz

Car Battery Adaptor: 12 V DC

Supplied accessories

See page 8.

Specifications and design are subject to change without notice.

Index

Numerics

16:9 16
4:3 Letter Box 16
4:3 Pan Scan 16

A

Angle Mark 7, 17
Audio 7, 17
Audio DRC 17
Audio Setup 17

C

CD 11, 23
Charging time and playing time 9

D

DATA 13, 23
Disc Menu 17
DVD 11, 23

G

General Setup 16

J

JPEG 13, 24

L

Language Setup 17
LCD Aspect 15
LCD Mode 15

M

MP3 13, 24
MPEG-4 (video file) 13, 24

O

OSD (On-Screen Display) 17

P

Parental Control 18
Password 18
PBC 12, 17
Playable Media 23
Playback Information Display 12

R

Random Play 5
Region code 24
Repeat Play 12
Resume Play 12

S

Screen Saver 12, 17
Setup 16
Slide Show 14
Subtitle 7, 17

T

Troubleshooting 19
TV Display 16

U

USB 14

V

VIDEO CD 11, 23
Video file (MPEG-4) 13, 24

Índice

Este manual explica los preparativos y el funcionamiento básico del reproductor portátil de CD/DVD. Para obtener más información, consulte el Manual de Instrucciones en inglés.

Control de accesorios	3
Carga de la batería	3
Reproducción de discos	4
Uso del adaptador para batería de automóvil	5

Control de accesorios

Compruebe que dispone de los siguientes elementos:

- Adaptador de CA (1)
- Adaptador para batería de automóvil (1)
- Cable de audio/video (1)
- Control remoto (1)
- Pilas AA (R6) (2)

Preparación del control remoto

Inserte dos pilas AA (R6) de manera tal que los extremos \oplus y \ominus coincidan con las marcas del interior del compartimiento.

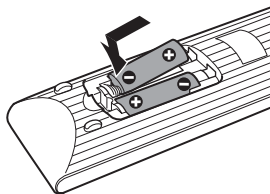

Carga de la batería

Cargue la batería recargable antes de utilizar el reproductor por primera vez o cuando la batería esté agotada.

1 Conecte el adaptador de CA.

Cuando comienza el proceso de carga, se enciende la luz naranja del indicador CHARGE.

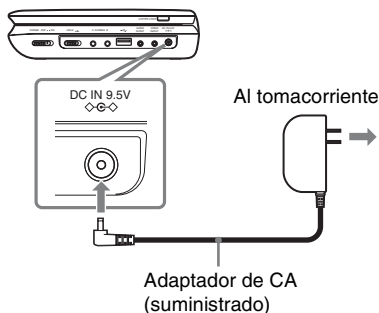

Cuando termina el proceso de carga, el indicador CHARGE se apaga. Desconecte el adaptador de CA.

ES

Tiempo de carga y tiempo de reproducción

Tiempo de carga: aproximadamente 6 horas

Tiempo de reproducción: aproximadamente 6 horas

Para controlar el nivel de batería

El indicador de batería se muestra cuando el reproductor está detenido.



Reproducción de discos

DVDVideo **DVDVR** **VCD** **CD**

DATA

De acuerdo con el disco, algunas operaciones pueden ser diferentes o estar restringidas. Consulte las instrucciones de operación proporcionadas con el disco. Cargue la batería con antelación o conecte el adaptador de CA.

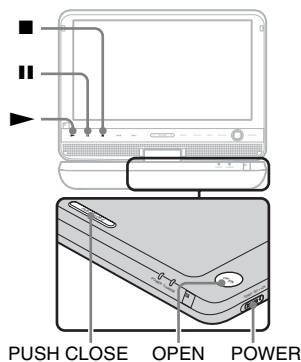

1 Abra el panel LCD.

2 Deslice el interruptor POWER a "ON".

3 Presione OPEN para abrir la tapa del disco.

4 Inserte el disco.

Ubíquelo con la cara de reproducción hacia abajo y empuje suavemente hasta que se ajuste con un clic. No toque la superficie de la lente.

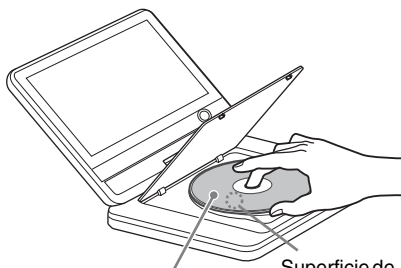

La cara de reproducción debe mirar hacia abajo

Superficie de la lente

5 Presione el PUSH CLOSE en la tapa del disco para cerrarla.

6 Presione ▶.

El reproductor comienza la reproducción.

De acuerdo con el disco, puede aparecer un menú. Presione ◀/▶/↵/→ para seleccionar el elemento y presione ENTER.

Para detener la reproducción

Presione ■.

Para poner en pausa la reproducción

Presione ||.

Para reanudar la reproducción desde donde detuvo el disco (Reanudar reproducción) **DVDVideo** **DVDVR** **VCD** **CD**

Cuando vuelve a presionar ▶ después de detener la reproducción, el reproductor comienza con la reproducción desde donde presionó ■.

Rotación y plegado del panel LCD

Abra el panel LCD en la posición vertical y luego rótelo lentamente 180 grados en el sentido de las agujas del reloj.

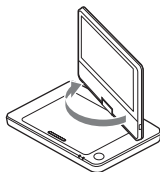

Después de rotar el panel LCD 180 grados en el sentido de las agujas del reloj, empuje el panel LCD hacia abajo sobre la carcasa del reproductor. En esta posición, el panel queda mirando hacia arriba.



Para volver a colocar el panel LCD en su posición original

Abra el panel LCD en la posición vertical y rótelo lentamente en el sentido contrario de las agujas del reloj.

Uso del adaptador para batería de automóvil

El adaptador para batería de automóvil (suministrado) está diseñado para una batería de automóvil de 12 V, con conexión a tierra negativa (no lo utilice con baterías de automóvil de 24 V y conexión a tierra positiva).

1 Conecte el adaptador para batería de automóvil.

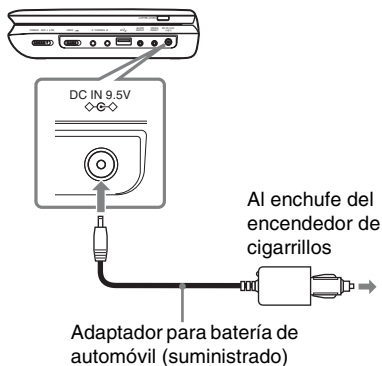

Después de usar el reproductor en el vehículo

Desconecte el adaptador para batería de automóvil del enchufe del encendedor de cigarrillos.

4-266-600-11(1)



* 1 - 4 2 6 6 6 0 0 1 1 . *