

CD/DVD Player

Operating Instructions



DVP-S336
DVP-S335

WARNING

To prevent fire or shock hazard, do not expose the unit to rain or moisture. To avoid electrical shock, do not open the cabinet. Refer servicing to qualified personnel only.

Mains cord must only be changed at qualified service shop.

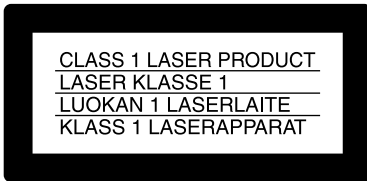

This appliance is classified as a CLASS 1 LASER product. The CLASS 1 LASER PRODUCT MARKING is located on the rear exterior.

CAUTION

The use of optical instruments with this product will increase eye hazard. As the laser beam used in this CD/DVD player is harmful to eyes, do not attempt to disassemble the cabinet.

Refer servicing to qualified personnel only.



This label is located on the Laser protective housing inside the enclosure.

Notice for customers in the United Kingdom and Republic of Ireland

A moulded plug complying with BS1363 is fitted to this equipment for your safety and convenience.

Should the fuse in the plug supplied need to be replaced, a 5 AMP fuse approved by ASTA or BSI to BS1362, (i.e., marked with ⚡ or ⚡ mark) must be used.

Welcome!

Thank you for purchasing the Sony CD/DVD Player. Before operating the unit, please read this manual thoroughly and retain it for future reference.

If the plug supplied with this equipment has a detachable fuse cover, be sure to attach the fuse cover after you change the fuse. Never use the plug without the fuse cover. If you should lose the fuse cover, please contact your nearest Sony service station.

Precautions

Safety

- This unit operates on 220 - 240 V AC, 50/60 Hz. Check that the unit's operating voltage is identical with your local power supply.
- If anything falls into the cabinet, unplug the unit and have it checked by qualified personnel before operating it any further.
- The unit is not disconnected from the mains as long as it is connected to the mains outlet, even if the unit itself has been turned off.
- Unplug the unit from the wall outlet if you do not intend to use it for an extended period of time. To disconnect the cord, pull it out by the plug, never by the cord.

Installing

- Allow adequate air circulation to prevent internal heat buildup.
- Do not place the unit on surfaces (rugs, blankets, etc.) or near materials (curtains, draperies) that may block the ventilation slots.
- Do not install the unit near heat sources such as radiators or air ducts, or in a place subject to direct sunlight, excessive dust, mechanical vibration or shock.
- Do not install the unit in an inclined position. It is designed to be operated in a horizontal position only.
- Keep the unit and discs away from equipment with strong magnets, such as microwave ovens or large loudspeakers.
- Do not place heavy objects on the unit.
- If the unit is brought directly from a cold to a warm location, moisture may condense inside the CD/DVD player and cause damage to the lenses. When you first install the unit, or when you move it from a cold to a warm location, wait for about 30 minutes before operating the unit.

TABLE OF CONTENTS

| | |
|--|---|
| About This Manual | 4 |
| This Player Can Play the Following Discs | 4 |
| Precautions | 6 |
| Notes About the Discs | 6 |

Getting Started 7

| | |
|--|----|
| Unpacking | 7 |
| TV Hookups | 8 |
| Receiver (Amplifier) Hookups | 11 |
| 2+1 Channel Surround Hookups | 13 |
| 5.1 Channel Surround Hookups | 14 |
| Selecting the Language for the On-Screen Display | 16 |
| Operation Sound Effects (Sound Feedback) | 17 |

Playing Discs 18

| | |
|---|----|
| Playing Discs | 18 |
| Searching for a Particular Point on a Disc | 20 |
| Resuming Playback from the Point Where You Stopped the Disc (Resume Play) | 21 |
| Using the DVD's Menu | 22 |
| Playing VIDEO CDs with PBC Functions (PBC Playback) | 23 |
| Using the Front Panel Display | 24 |

Using Various Functions with the Control Menu 26

| | |
|---|----|
| Using the Control Menu Display | 26 |
| Control Menu Item List | 28 |
| Searching for a Title/Chapter/Track/Index/Scene | 29 |
| Checking the Playing Time and Remaining Time | 30 |
| Selecting a Starting Point Using the Time Code | 30 |
| Viewing the Disc Information | 31 |
| Changing the Sounds | 32 |
| Displaying the Subtitles | 34 |
| Changing the Angles | 35 |
| Digital Cinema Sound Settings | 36 |
| Checking the Play Information | 37 |
| Locking Discs (Custom Parental Control) | 38 |
| Creating Your Own Program (Program Play) | 40 |
| Playing in Random Order (Shuffle Play) | 42 |
| Playing Repeatedly (Repeat Play) | 43 |
| Repeating a Specific Portion (A-B Repeat) | 44 |

Settings and Adjustments 46

| | |
|--|----|
| Using the Setup Display | 46 |
| Setup Display Item List | 48 |
| Setting the Display Language or Sound Track (LANGUAGE SETUP) | 49 |
| Settings for the Display (SCREEN SETUP) | 50 |
| Custom Settings (CUSTOM SETUP) | 51 |
| Settings for the Sound (AUDIO SETUP) | 55 |
| Subwoofer Set Up (SPEAKER SETUP) | 57 |





Additional Information 59

| | |
|-----------------------------|----|
| Troubleshooting | 59 |
| Self-diagnosis function | 62 |
| Specifications | 63 |
| Glossary | 64 |
| Language Code List | 66 |
| Index to Parts and Controls | 67 |
| Index | 70 |



About This Manual

Conventions

- Instructions in this manual describe the controls on the player. You can also use the controls on the remote if they have the same or similar names as those on the player.
- The icons on the right are used in this manual:

| Icon | Meaning |
|---|--|
|  | Indicates that you can use only the remote to do the task. |
|  | Indicates tips and hints for making the task easier. |
|  | Indicates that the function is for DVD VIDEOS. |
|  | Indicates that the function is for VIDEO CDs. |
|  | Indicates that the function is for Audio CDs. |

This Player Can Play the Following Discs

| | DVD VIDEOS | | VIDEO CDs | | Audio CDs | |
|-----------|--|--|---|---------|--|------------------|
| Disc logo |  | |  | |  | |
| Contents | Audio + Video | | Audio + Video | | Audio | |
| Disc size | 12 cm | 8 cm | 12 cm | 8 cm | 12 cm | 8 cm (CD single) |
| Play time | About 4 h (for single-sided DVD)/ about 8 h (for double-sided DVD) | About 80 min. (for single-sided DVD)/ about 160 min. (for double-sided DVD) | 74 min. | 20 min. | 74 min. | 20 min. |

The "DVD VIDEO" logo is a trademark.

When you play an NTSC disc, this player outputs the video signal in the NTSC system only. In this case, if your TV uses the PAL system, the picture becomes noisy.

Region code of DVDs you can play on this unit

Your DVD player has a region code printed on the back of the unit and will only play DVDs that are labeled with identical region codes.

DVDs labeled  will also play on this unit.

If you try to play any other DVD, the message "Playback prohibited by area limitations." will appear on the TV screen.

Depending on the DVD, no region code indication may be labeled even though playing the DVD is prohibited by area restrictions.

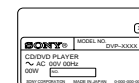

Region code

Note on playback operations of DVDs and VIDEO CDs

Some playback operations of DVDs and VIDEO CDs may be intentionally fixed by software producers. Since this player plays DVDs and VIDEO CDs according to the disc contents the software producers designed, some playback features may not be available. Also refer to the instructions supplied with the DVDs or VIDEO CDs.

Terms for discs

- **Title**
The longest section of a picture or music feature on a DVD, the movie, etc. in video software, or the name of an album in audio software.
- **Chapter**
Sections of a picture or a music feature that are smaller than titles. A title is composed of several chapters. Each chapter is assigned a chapter number enabling you to locate the chapter you want. Depending on the disc, no chapters may be recorded.
- **Track**
Sections of a picture or a music feature on a VIDEO CD or a CD. Each track is assigned a track number enabling you to locate the track you want.

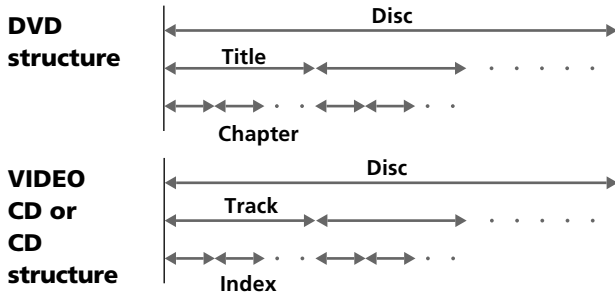

- **Index (CD) / Video Index (VIDEO CD)**
A number that divides a track into sections to easily locate the point you want on a VIDEO CD or a CD. Depending on the disc, no indexes may be recorded.
- **Scene**
On a VIDEO CD with PBC (playback control) functions, the menu screens, moving pictures and still pictures are divided into sections called "scenes." Each scene is assigned a scene number enabling you to locate the scene you want.

Note on PBC (Playback Control) (VIDEO CDs)

This player conforms to Ver. 1.1 and Ver. 2.0 of VIDEO CD standards. You can enjoy two kinds of playback according to the disc type.

| Disc type | You can |
|--|---|
| VIDEO CDs without PBC functions (Ver. 1.1 discs) | Enjoy video playback (moving pictures) as well as music. |
| VIDEO CDs with PBC functions (Ver. 2.0 discs) | Play interactive software using menu screens displayed on the TV screen (PBC Playback), in addition to the video playback functions of Ver 1.1 discs. Moreover, you can play high-resolution still pictures if they are included on the disc. |

Discs that the player cannot play

The player cannot play discs other than the ones listed in the table on page 4. CD-Rs, CD-ROMs including PHOTO CDs, data sections in CD-EXTRAS, DVD-ROMs, DVD-audio, HD (high density) layer of Super Audio CD etc., cannot be played.

When playing DTS*-encoded CDs, excessive noise will be heard from the analog stereo outputs. To avoid possible damage to the audio system, the consumer should take proper precautions when the analog stereo outputs of the DVD player are connected to an amplification system. To enjoy DTS Digital Surround™ playback, an external 5.1-channel DTS Digital Surround™ decoder system must be connected to the digital output of the DVD player.

This product incorporates copyright protection technology that is protected by method claims of certain U.S. patents and other intellectual property rights owned by Macrovision Corporation and other rights owners. Use of this copyright protection technology must be authorized by Macrovision Corporation, and is intended for home and other limited viewing uses only unless otherwise authorized by Macrovision Corporation. Reverse engineering or disassembly is prohibited.

* "DTS" is a trademark of Digital Theater Systems, Inc.

Precautions

On safety

- Caution – The use of optical instruments with this product will increase eye hazard.
- Should any solid object or liquid fall into the cabinet, unplug the player and have it checked by qualified personnel before operating it any further.

On power sources

- The player is not disconnected from the AC power source (mains) as long as it is connected to the wall outlet, even if the player itself has been turned off.
- If you are not going to use the player for a long time, be sure to disconnect the player from the wall outlet. To disconnect the AC power cord (mains lead), grasp the plug itself; never pull the cord.
- Should the AC power cord (mains lead) need to be changed, have it done at a qualified service shop only.

On placement

- Place the player in a location with adequate ventilation to prevent heat build-up in the player.
- Do not place the player on a soft surface such as a rug that might block the ventilation holes on the bottom.
- Do not place the player in a location near heat sources, or in a place subject to direct sunlight, excessive dust or mechanical shock.

On operation

- If the player is brought directly from a cold to a warm location, or is placed in a very damp room, moisture may condense on the lenses inside the player. Should this occur, the player may not operate properly. In this case, remove the disc and leave the player turned on for about half an hour until the moisture evaporates.
- When you move the player, take out any discs. If you don't, the disc may be damaged.

On adjusting volume

- Do not turn up the volume while listening to a portion with very low level inputs or no audio signals. If you do, the speakers may be damaged when a peak level portion is played.

On cleaning

- Clean the cabinet, panel and controls with a soft cloth slightly moistened with a mild detergent solution. Do not use any type of abrasive pad, scouring powder or solvent such as alcohol or benzine.

If you have any questions or problems concerning your player, please consult your nearest Sony dealer.

IMPORTANT NOTICE

Caution: The enclosed DVD player is capable of holding a still video image or on-screen display image on your television screen indefinitely. If you leave the still video image or on-screen display image displayed on your TV for an extended period of time you risk permanent damage to your television screen. Projection televisions are especially susceptible to this.

Notes About the Discs

On handling discs

- To keep the disc clean, handle the disc by its edge. Do not touch the surface.
- Do not stick paper or tape on the disc. If there is glue (or a similar substance) on the disc, remove the glue completely before using the disc.

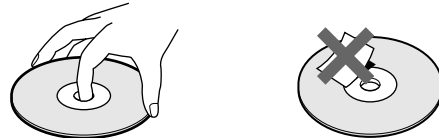

- Do not expose the disc to direct sunlight or heat sources such as hot air ducts, or leave it in a car parked in direct sunlight as the temperature may rise considerably inside the car.
- After playing, store the disc in its case.

On cleaning

- Before playing, clean the disc with a cleaning cloth. Wipe the disc from the center out.

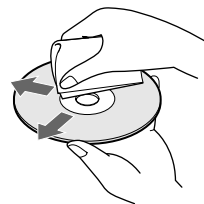

- Do not use solvents such as benzine, thinner, commercially available cleaners or anti-static spray intended for vinyl LPs.

On novelty discs

- Do not use irregularly shaped CDs such as heart- or star-shaped CDs as they may cause the player to malfunction.

Getting Started

This section describes how to hook up the CD/DVD player to a TV (with audio/video input jacks) and/or an AV receiver (amplifier). You cannot connect this player to a TV which does not have a video input connector. Be sure to turn off the power of each component before making the connections.

Unpacking

Check that you have the following items:

- Audio/video connecting cord (1)
- Remote commander (remote) RMT-D115P (1)
- R6 (size AA) batteries (2)

Inserting batteries into the remote

You can control the player using the supplied remote. Insert two R6 (size AA) batteries by matching the + and - ends on the batteries to the markings inside the compartment. When using the remote, point it at the remote sensor  on the player.

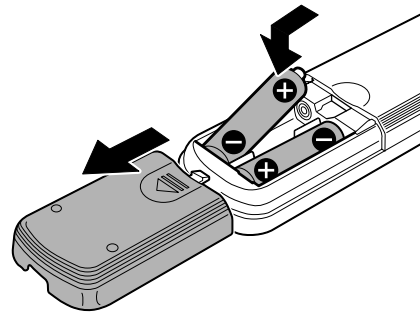

Notes

- Do not leave the remote in an extremely hot or humid place.
- Do not drop any foreign object into the remote casing, particularly when replacing the batteries.
- Do not expose the remote sensor to direct sunlight or lighting apparatuses. Doing so may cause a malfunction.
- If you do not use the remote for an extended period of time, remove the batteries to avoid possible damage from battery leakage and corrosion.

TV Hookups

This connection is for listening to the sound through TV speakers (L:left, R:right). Refer to the instructions supplied with the component to be connected. You cannot connect this player to a TV without a SCART (EURO AV) connector or a video input connector.

 **You can enjoy surround sound with built-in TV speakers only**
You can use 3D sound imaging to create virtual rear speakers from the sound of built-in TV speakers without using actual rear speakers (VES TV: Virtual Enhanced Surround TV). For details, see page 36.

Required cords

SCART (EURO AV) connecting cord (not supplied) (2)

Be sure to make connections firmly to avoid hum and noise. Refer to the instructions supplied with the TV to be connected.



Notes

- When you set "LINE" to "S VIDEO" or "RGB" under "CUSTOM SETUP" in the setup display, use a SCART (EURO AV) connecting cord that conforms to each signal.
- When you connect using the SCART (EURO AV) connecting cord, confirm that the TV corresponds to S VIDEO or RGB. Refer to the instructions supplied with the TV to be connected as well.

CD/DVD player

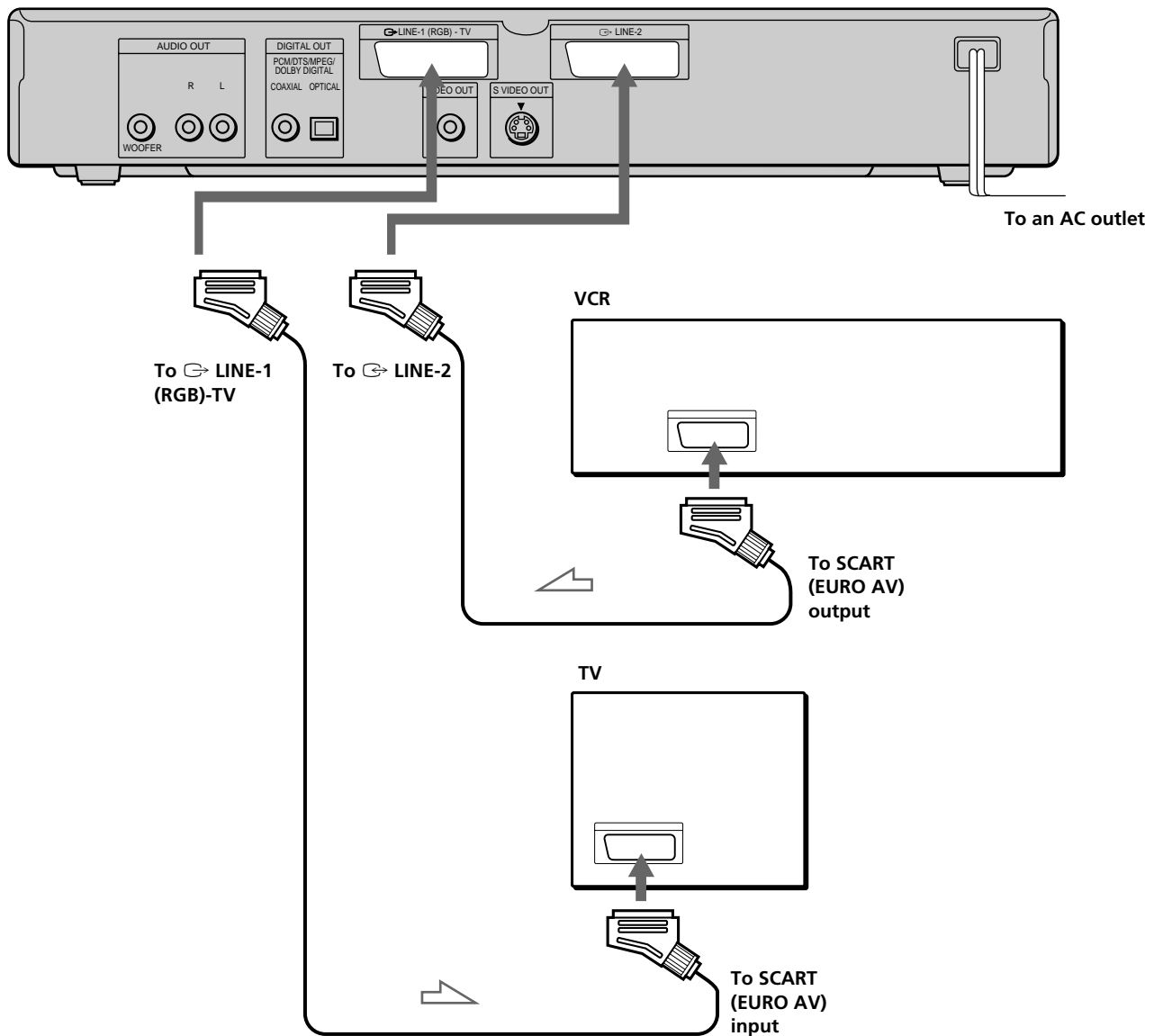

 : Signal flow

If your TV has two SCART (EURO AV) connectors

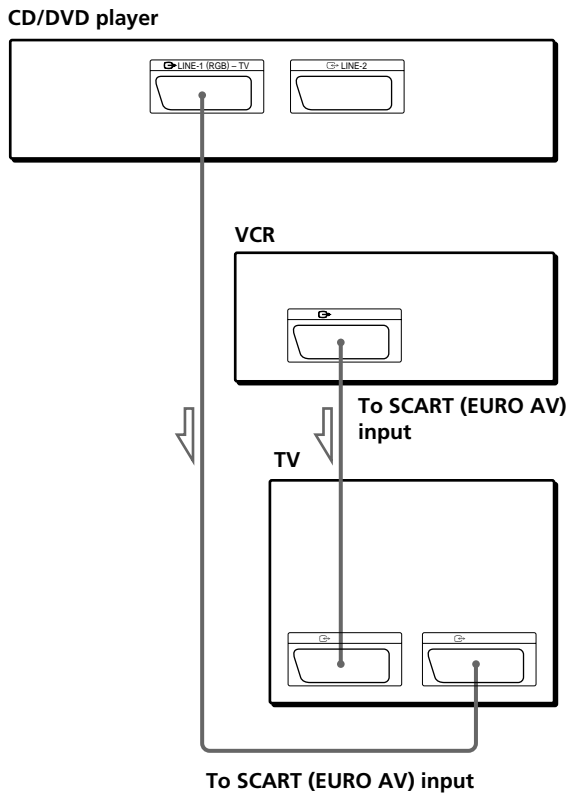

If your TV has no SCART (EURO AV) connectors

You can connect the player to a TV (with audio/video input jacks) using the supplied audio/video connecting cord. If your TV has an S video input connector, connect the component via the S VIDEO OUT connector using an S video cord (not supplied) instead of the video connecting cord. You will get a better picture. When connecting the cords, be sure to match the color-coded cord to the appropriate jacks on the components: Yellow (video) to Yellow, Red (right) to Red and White (left) to White.

Audio/Video connecting cord (supplied) (1)

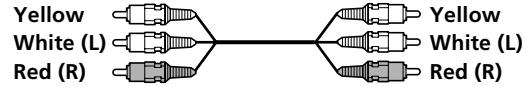

■ To listen to the sound through TV speakers

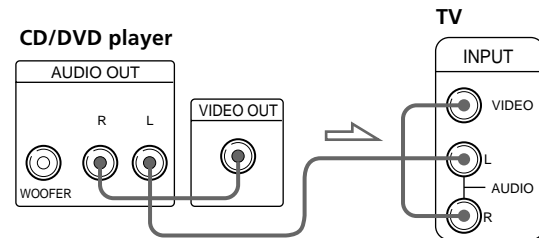

■ If your TV has an S video input connector

S video cord (not supplied) (1)

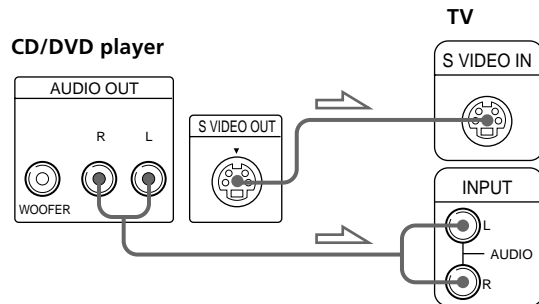

Notes

- Refer to the instructions supplied with the component to be connected.
- Do not connect this player to a video deck. If you do, noise may appear in the picture.

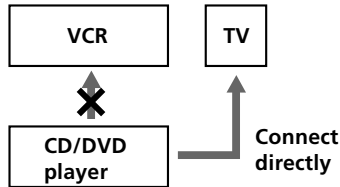

- Depending on the TV or receiver (amplifier), sound distortion may occur because the audio output level is high. In this case, set "AUDIO ATT" in "AUDIO SETUP" to "ON" in the setup display. For details, see page 55.
- If you cannot view the pictures from a VCR through this player which is connected to a TV with RGB component connectors, set to (Audio/Video) on your TV. When you select (RGB), the TV cannot receive the signal from the VCR.
- If you want to use your VCR's SmartLink function, connect the VCR to your TV's SmartLink connector and connect the CD/DVD player to the TV with another connector.
- When you connect the player to your TV via the SCART (EURO AV) connectors, the TV's input source is set to the player automatically when you start playback or press any button except for on the player or on the remote. In this case, press TV/DVD on the remote to return the input to the TV.

Setups for the player

Some setup adjustments are necessary for the player depending on the TV or other components to be connected.

Use the setup display to change the various settings. For details on using the setup display, see page 46.

- **To connect the player to a wide-screen TV**
In the setup display, set "TV TYPE" in "SCREEN SETUP" to "16:9" (default setting). For details, see page 50.
- **To connect the player to a normal TV**
In the setup display, set "TV TYPE" in "SCREEN SETUP" to "4:3 LETTER BOX" or "4:3 PAN SCAN." For details, see page 50.
- **To connect the player to a TV or VCR via a SCART (EURO AV) connector that conforms to the S video signals or RGB signals**
In the setup display, set "LINE" in "CUSTOM SETUP" to "S VIDEO" or "RGB." For details, see page 51.

When you play a disc recorded in the NTSC color system, the player outputs the video signal or the setup display etc. in the NTSC color system and the picture may not appear on PAL color system televisions. In this case, open the disc tray and remove the disc.

Receiver (Amplifier) Hookups

This connection is for listening to the sound through speakers connected to a receiver lacking a built-in DTS, Dolby* Digital or MPEG decoder. Refer to the instructions supplied with the component to be connected as well.

You can enjoy surround sounds even if you connect front speakers only

You can use 3D sound imaging to create virtual rear speakers from the sound of the front speakers (L, R) without using actual rear speakers (VES:Virtual Enhanced Surround). For details, see page 36.

If you have a digital component with a built-in DTS, Dolby Digital or MPEG decoder

You can enjoy multi-channel surround sound by connecting the component via the DIGITAL OUT OPTICAL or COAXIAL connector using an optical or coaxial digital connecting cord (not supplied). For details on hookups and settings, see page 14.

* Manufactured under license from Dolby Laboratories. "Dolby," "Pro Logic" and the double-D symbol are trademarks of Dolby Laboratories. Confidential unpublished works. ©1992-1997 Dolby Laboratories. All rights reserved.

Required cords

Audio connecting cord (not supplied) (1)

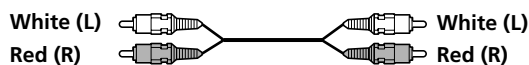

S video cord (not supplied) (1)



When connecting the cords, be sure to match the color-coded cord to the appropriate jacks on the components: Red (right) to Red and White (left) to White. Be sure to make connections firmly to avoid hum and noise.

If you have a digital component such as a receiver (amplifier) with a digital connector, DAT or MD, connect the component via the DIGITAL OUT OPTICAL or COAXIAL connector using an optical or coaxial digital connecting cord (not supplied).

Optical digital connecting cord (not supplied) (1)



Coaxial digital connecting cord (not supplied) (1)

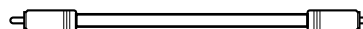

CD/DVD player

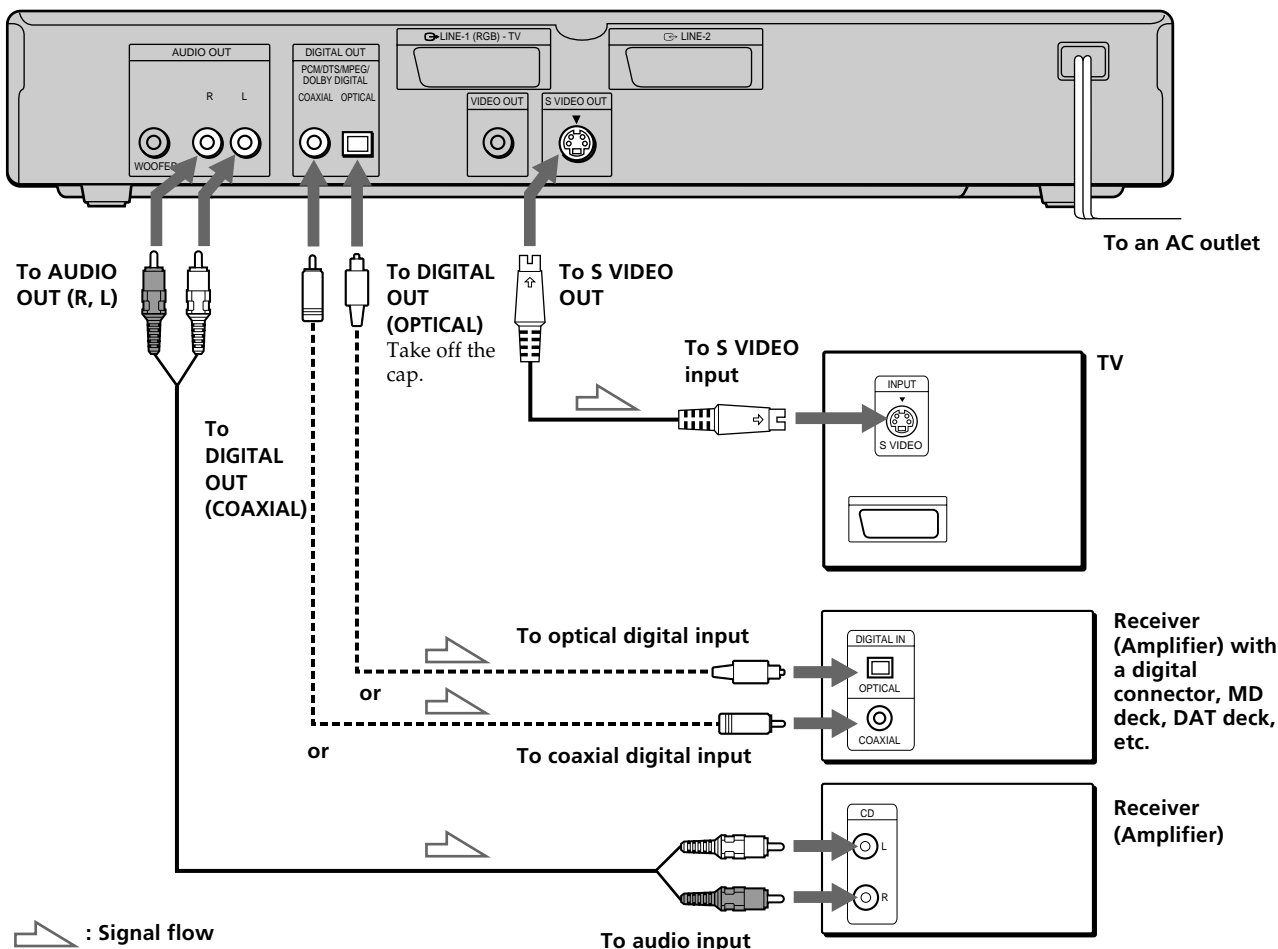

Receiver (Amplifier) Hookups

Notes

- You cannot enjoy a picture with an S video signal if your TV does not conform to the S video signal. When your TV does not have an S VIDEO input, connect the component via the VIDEO INPUT connector using the video connecting cord (not supplied) instead of the S video cord. For details, see page 9. Refer to the instructions supplied with your TV.
- Refer to the instructions supplied with the component to be connected.
- You cannot make digital audio recordings of discs recorded in multi-channel surround format directly using an MD deck or DAT deck.
- When you connect the component via the DIGITAL OUT OPTICAL or COAXIAL connector, set Virtual Enhanced Surround (VES) to "OFF." Otherwise, the player will not output signals from the DIGITAL OUT OPTICAL or COAXIAL connector.

When you have made the connections using an optical or coaxial digital connecting cord, do not set "DOLBY DIGITAL" to "DOLBY DIGITAL," "MPEG" to "MPEG" and "DTS" to "ON." If you do, a loud noise will suddenly come out from the speakers, affecting your ears or causing the speakers to be damaged.

Setups for the player

Some setup adjustments are necessary for the player depending on the components to be connected. Use the setup display to change the various settings. For details on using the setup display, see page 46.

- **To listen to the sound through speakers connected to a receiver (amplifier) which has a digital connector and lacks a built-in DTS, Dolby Digital or MPEG decoder, or to output the sound to a digital component such as a D/A or MD deck**

Set the "AUDIO SETUP" items in the setup display (page 55) as shown in the illustration below. These are the default settings.

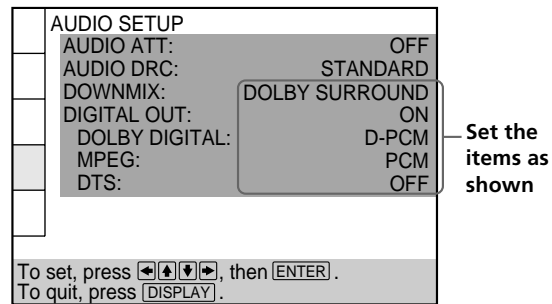

Set "VES" to "OFF" in the Control Menu display (page 36). When you select the VES mode other than "OFF," the Virtual Enhanced Surround (VES) effect cannot be heard.

Note

When you output the signals which do not reproduce the Dolby Surround (Pro Logic) effect from the DIGITAL OUT OPTICAL or COAXIAL connector, set "DOWNMIX" to "NORMAL" in "AUDIO SETUP" in the setup display (page 56).

2+1 Channel Surround Hookups

This connection is for listening to the sound through the left and right speakers of the TV, or speakers connected to a receiver and the subwoofer. You can enjoy rich bass frequencies by connecting a subwoofer. Refer to the instructions supplied with the component to be connected.

Set "SUBWOOFER" in "SPEAKER SETUP" to "YES" in the setup display (page 57). Then set "FRONT SPEAKER SIZE" to "TV" when you use the TV's speakers, or "LARGE," "MIDDLE" or "SMALL" when you use the speakers connected to the receiver.

You can enjoy surround sound with front speakers only

You can use 3D sound imaging to create virtual rear speakers from the sound of the front speakers (L, R) without using actual rear speakers (Virtual Enhanced Surround). For details, see page 36.

Required cords

Audio connecting cord (not supplied) (1)

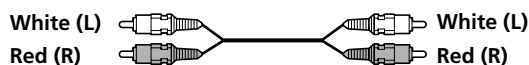

S video cord (not supplied) (1)



When connecting the cords, be sure to match the color-coded cord to the appropriate jacks on the components: Red (right) to Red and White (left) to White. Be sure to make connections firmly to avoid hum and noise.

Monaural audio cord (not supplied) (1)

One for a subwoofer

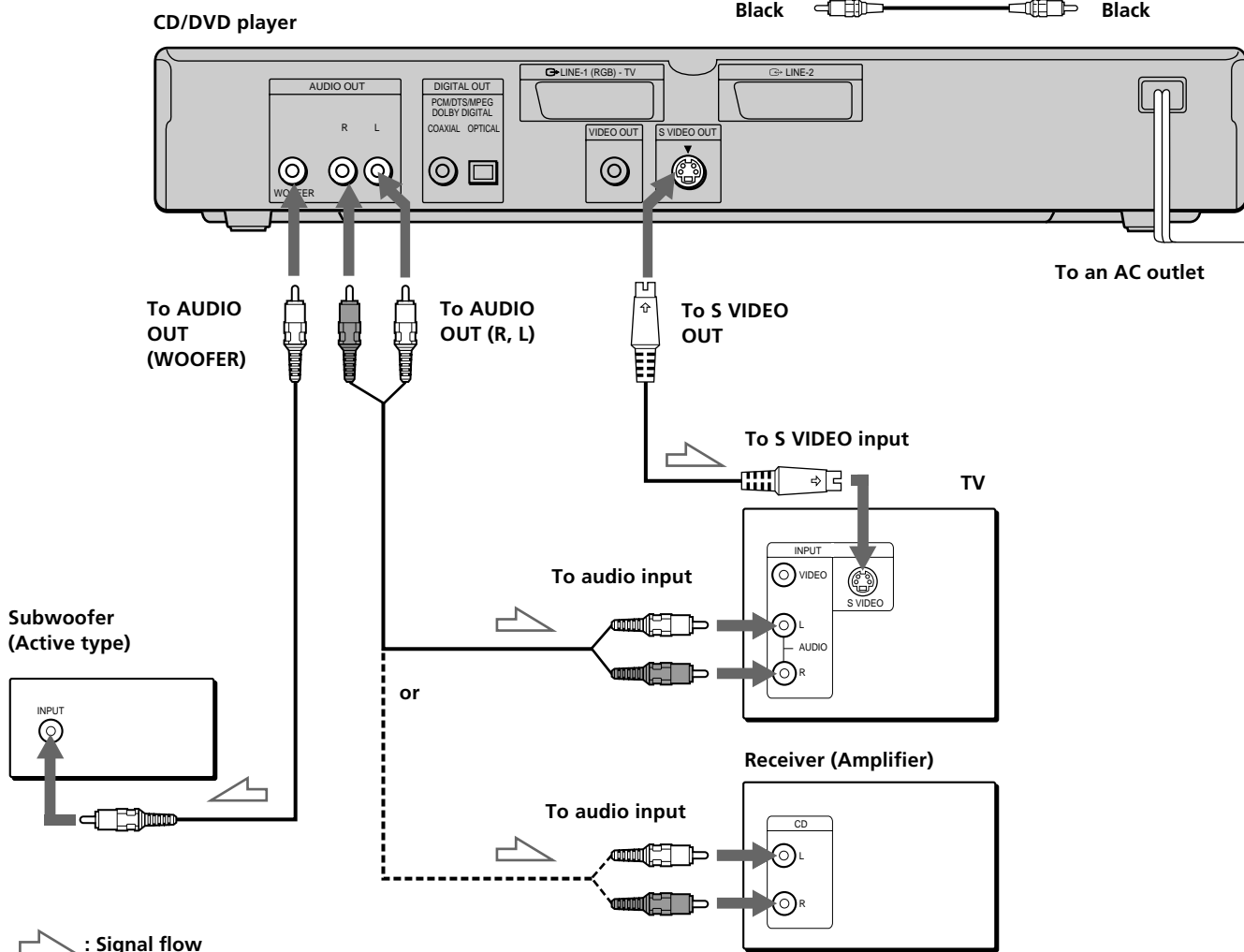

Note

You cannot enjoy a picture with an S video signal if your TV does not conform to the S video signal. When your TV does not have an S VIDEO input, connect the component via the VIDEO INPUT connector using the video connecting cord (not supplied) instead of the S video cord. For details, see page 9. Refer to the instructions supplied with your TV.

5.1 Channel Surround Hookups

With DVDs which contain DTS, Dolby Digital or MPEG AUDIO sound, you can enjoy the surround sound while producing the effect of being in a movie theater or a concert hall using a digital component with a built-in DTS, Dolby Digital or MPEG decoder (not supplied). The player outputs the surround sound signals from the DIGITAL OUT OPTICAL and COAXIAL connectors. Using a receiver (amplifier) having the OPTICAL or COAXIAL connector and 6 speakers, you can enjoy even greater real audio presence in the comfort of your own home.

Note

When a DVD has a sound track with 7.1 channels recorded in MPEG AUDIO format, the output audio signals are mixed down to 5.1 channels.

Required cords

Optical digital connecting cord* (not supplied) (1)



Coaxial digital connecting cord* (not supplied) (1)

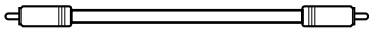

S video cord (not supplied) (1)



* Connect the component via the DIGITAL OUT OPTICAL or COAXIAL connector using an optical or coaxial digital connecting cord (not supplied). You do not need to connect both of these cords. See the figure on the next page.

Notes

- Do not connect the power cord to an AC outlet or press the POWER switch before completing all connections.
- Refer to the instructions supplied with the component to be connected.
- The cord connectors should be fully inserted into the jacks. Loose connection may cause hum and noise.

Setups for the player

Some setup adjustments are necessary for the player depending on the components to be connected. Use the setup display to change the various settings. For details on using the setup display, see page 46.

- **When you connect an audio component with a built-in Dolby Digital decoder^A**

Set "DIGITAL OUT" in "AUDIO SETUP" to "ON" and then set "DOLBY DIGITAL" to "DOLBY DIGITAL" in the setup display. (page 56)

- **When you connect an audio component with a built-in MPEG decoder^B**

Set "DIGITAL OUT" in "AUDIO SETUP" to "ON" and then set "MPEG" to "MPEG" in the setup display. (page 56)

- **When you connect an audio component with a built-in DTS decoder^C**

Set "DIGITAL OUT" in "AUDIO SETUP" to "ON" and then set "DTS" to "ON" in the setup display. (page 56)

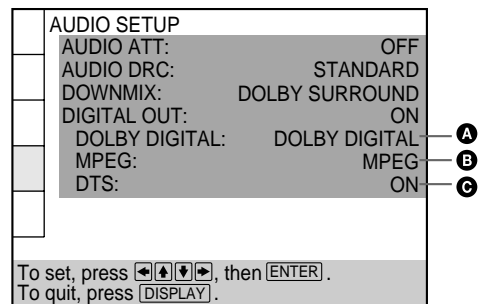

Notes

- When you do not connect an audio component with a built-in Dolby Digital decoder do not set "DOLBY DIGITAL" to "DOLBY DIGITAL."
- When you do not connect an audio component with a built-in MPEG decoder do not set "MPEG" to "MPEG."
- When you do not connect an audio component with a built-in DTS decoder do not set "DTS" to "ON."

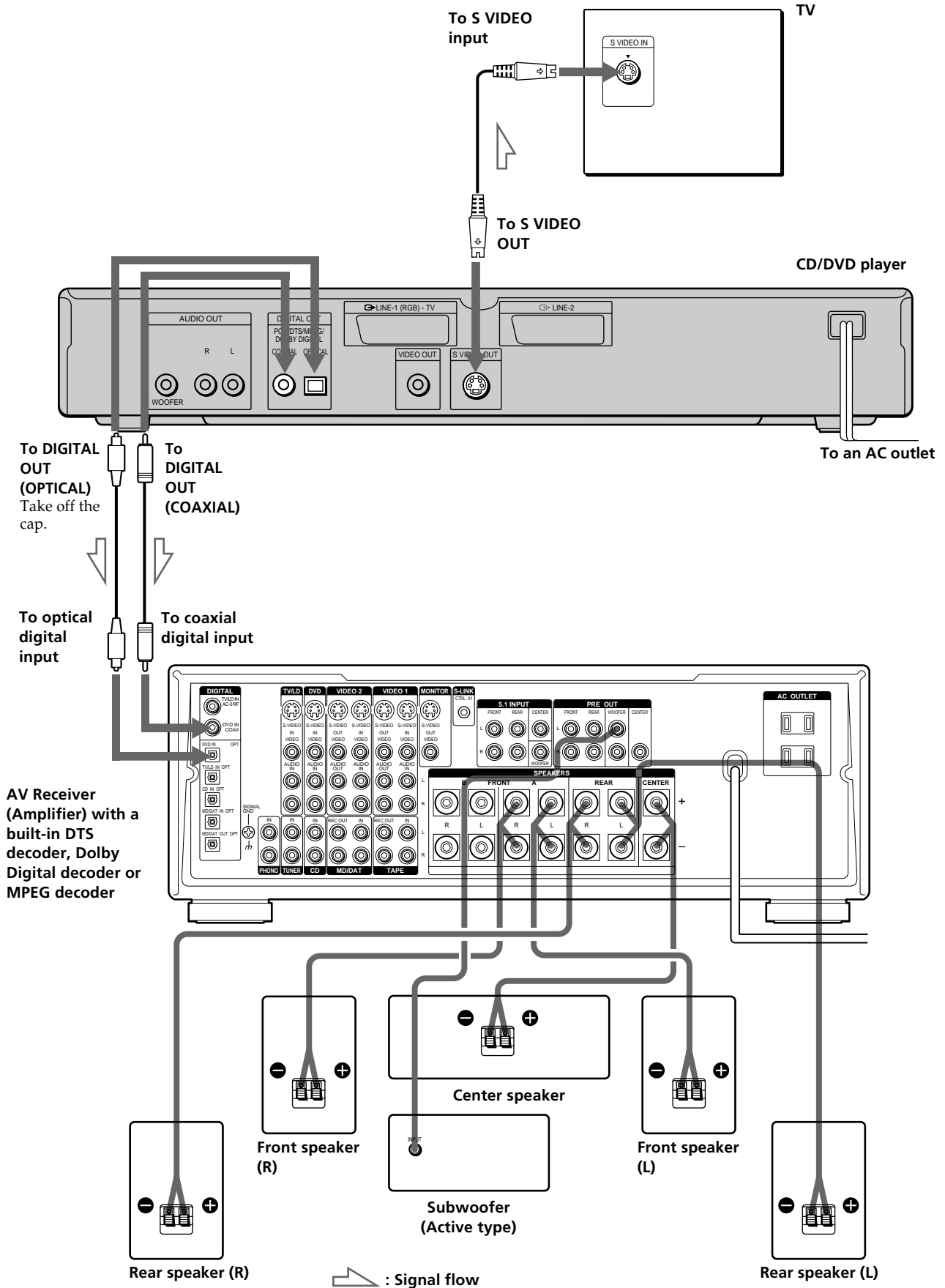

Selecting the Language for the On-Screen Display

You can select the language for the setup display, the Control Menu display or the messages displayed on the screen. The default setting is "ENGLISH."

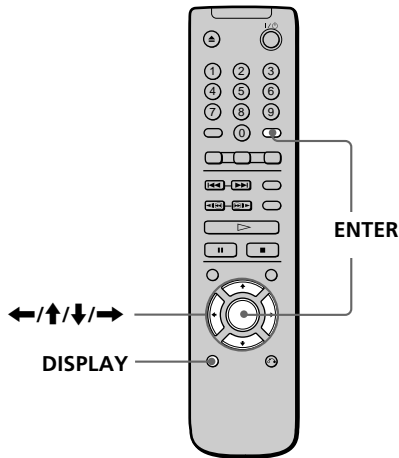

- 1 When the player is in stop mode, press DISPLAY and select "SETUP" using \uparrow/\downarrow .

The on-screen menu items are different depending on whether there is a disc in the player or not.

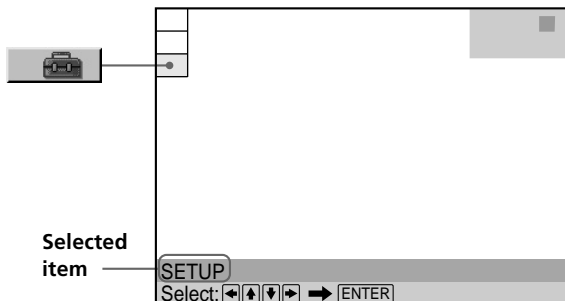

- 2 Press ENTER.

The setup display appears on the TV screen.

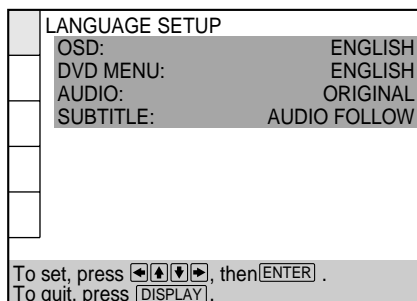

- 3 Select "LANGUAGE SETUP" using \uparrow/\downarrow , and then press ENTER.

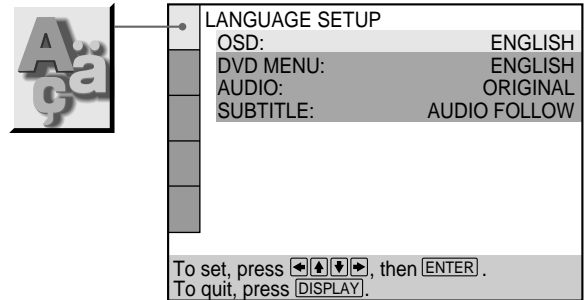

- 4 Select "OSD" using \uparrow/\downarrow , then press \rightarrow or ENTER.

The languages you can select are displayed. These languages are different depending on the player model.

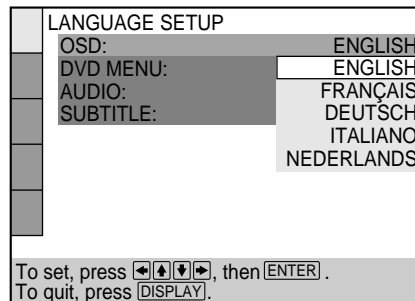

- 5 Select the desired language using \uparrow/\downarrow , then press ENTER.



- 6 Press DISPLAY.

The setup display disappears.

- 7 Press DISPLAY repeatedly to turn off the on-screen menu.

To return to the previous screen

Press  RETURN.

To quit while making a selection

Press DISPLAY.



Note

The languages you can select are the ones displayed in step 4.
For details, see page 49.

Operation Sound Effects (Sound Feedback)

The player beeps when the following operations are performed.

The default setting of the Sound Feedback function is set to off.

| Operation | Operation sound |
|--|-----------------|
| Power is turned on | One beep |
| Power is turned off | Two beeps |
|  is pressed | One beep |
|  is pressed | Two beeps |
| Playback is stopped | One long beep |
| Operation is not possible | Three beeps |

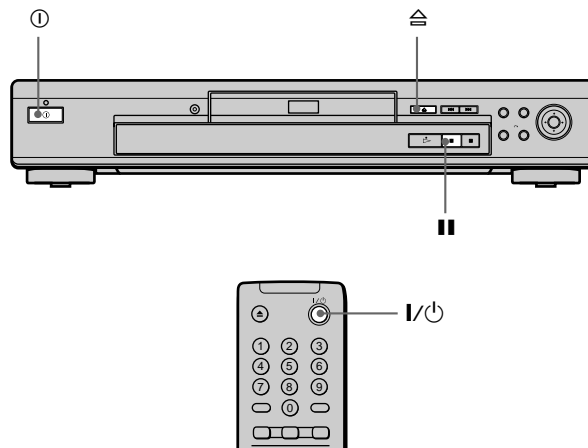

1 Press ① on the player then press I/⏻ on the remote.

The power indicator lights up in green.

When there is a disc in the player, press ② and remove the disc. Then press ② again to close the disc tray.

2 Press and hold  on the player for more than two seconds.

You will hear one beep and the Sound Feedback function is turned on.

To turn off the Sound Feedback Function

When there is no disc in the player, press and hold  on the player for more than two seconds. You will hear two beeps and the Sound Feedback function is turned off.

Playing Discs

This chapter describes how to play a DVD/CD/VIDEO CD.

When you play a disc recorded in the NTSC color system, the player outputs the video signal or the setup display etc. in the NTSC color system and the picture may not appear on PAL color system televisions. In this case, open the disc tray and remove the disc.

Playing Discs

Depending on the DVD or VIDEO CD, some operations may be different or restricted. Refer to the instructions supplied with your disc.

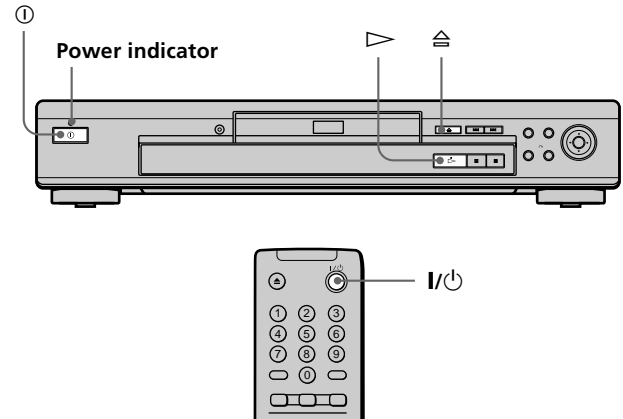

1 Turn on your TV

Turn on the TV and select the video input so that you can view the pictures from this player.

When using a receiver (amplifier)

Turn on the receiver (amplifier) and select the appropriate position so that you can listen to the sound from this player.

2 Press ① on the player

The player enters standby mode and the power indicator lights up in red.

3 Press on the player and place a disc on the disc tray.

The player automatically turns on and the power indicator lights up in green.

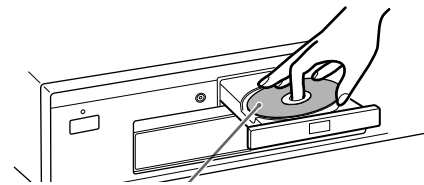

With the playback side facing down

4 Press .

The disc tray closes and the player starts playback (continuous play). Adjust the volume on the TV or the receiver (amplifier).

After following Step 4

■ When playing a DVD

A DVD menu or title menu may appear on the TV screen (see page 22).

■ When playing a VIDEO CD

A menu may appear on the TV screen depending on the VIDEO CD. You can play the disc interactively, following the instructions on the menu. (PBC Playback, see page 23.)

To turn on the player

Press **⏻** on the player. The player enters standby mode and the power indicator lights up in red. Then press **⏻/⏪** on the remote. The player turns on and the power indicator lights up in green. In standby mode, the player also turns on by pressing **⏻** on the player or by pressing **▶**.

To turn off the player

Press **⏻/⏪** on the remote. The player enters standby mode and the power indicator lights up in red. To disconnect the power of the player, press **⏻** on the player.

Notes on playing DTS sound tracks on a CD

- Do not play DTS sound tracks without first connecting the player to an audio component having a built-in DTS decoder. The player outputs the DTS signal via the DIGITAL OUT OPTICAL and COAXIAL connectors even if "DTS" in "AUDIO SETUP" is set to "OFF" in the setup display, and may affect your ears or cause your speakers to be damaged.
- Set the sound to "STEREO" when you play DTS sound tracks on a CD. (See "Changing the Sounds" on page 32.) If you set the sound to "1/L" or "2/R", no sound will come from the DIGITAL OUT OPTICAL and COAXIAL connectors.
- If you play a CD with a DTS sound track, a loud noise may come out from the AUDIO OUT connectors, affecting your ears or causing the speakers to be damaged.

Notes on playing DTS sound tracks on a DVD

- The signals of the DTS sound tracks are output from the DIGITAL OUT OPTICAL and COAXIAL connectors only. No sound will output from the AUDIO OUT connectors.
- If the player is connected to an audio component lacking a built-in DTS decoder, do not set "DTS" in "DIGITAL OUT" to "ON" in the setup display. Otherwise, when you play the DTS sound track, a loud noise will come out from the speakers, affecting your ears or causing the speakers to be damaged.
 - When you set "DTS" in "AUDIO SETUP" to "OFF", no sound will come out from the DIGITAL OUT OPTICAL and COAXIAL connectors even if you play DTS sound tracks on DVDs.

Notes

- If you leave the player or the remote in pause or stop mode for 15 minutes, the screen saver image appears automatically. To make the screen saver image go away, press **▶**. (If you want to set the screen saver function to off, see page 50.)
- If you don't operate the player or the remote for more than 30 minutes when a disc is not being played, the power is automatically turned off. (Auto Power Off function)
- While playing a disc, do not turn off the player by pressing **⏻**. Doing so may cancel the settings of the menu. When you turn off the player, press **■** first to stop playback and then press **⏻/⏪** on the remote. After the power indicator lights up in red and the player enters standby mode, press **⏻** on the player.

Additional operations

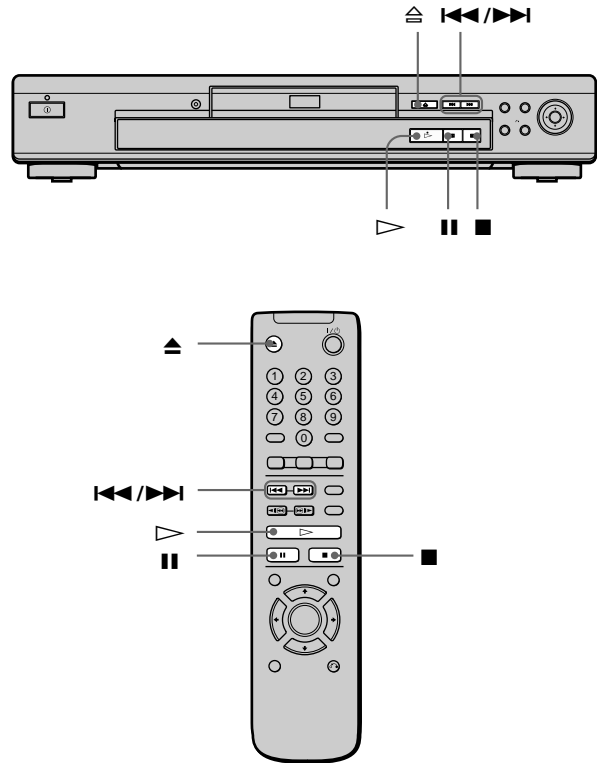

| To | Operation |
|--|------------------------------|
| Stop | Press ■ . |
| Pause | Press ⏪ . |
| Resume play after pause | Press ⏪ or ▶ . |
| Go to the next chapter, track or scene in continuous play mode | Press ▶▶▶ . |
| Go back to the preceding chapter, track or scene in continuous play mode | Press ◀◀◀ . |
| Stop play and remove the disc | Press ▲ . |

You can play discs in various modes such as Program Play using the on-screen menu (Control Menu). For Control Menu operations, see page 26.

Searching for a Particular Point on a Disc



You can locate a particular point on a disc quickly by monitoring the picture or playing back slowly.

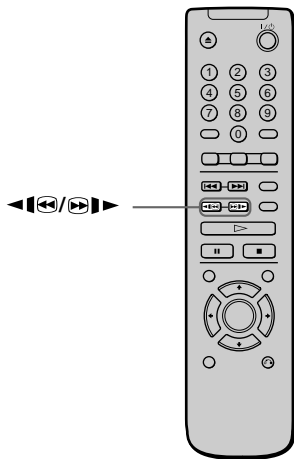

Note

Depending on the DVD/VIDEO CD, you may not be able to do some of the operations described.

Locating a point quickly by playing a disc in fast forward or fast reverse (Scan)

Press or while playing a disc. When you find the point you want, press to return to normal speed. Each time you press the or during Speed scan, the playback speed changes. Three speeds are available. With each press, the indication changes as follows:

Playback direction

x2▶ (DVD/CD only) → 1▶▶ → 2▶▶

Opposite direction

x2◀ (DVD only) → 1◀◀ → 2◀◀

The playback speed of x2▶/x2◀ is about twice the normal speed. The playback speed of 2▶▶/2◀◀ is faster than 1▶▶/1◀◀.

Locating a point slowly by watching the screen (Slow-motion play)



You can use this function only for DVDs or VIDEO CDs. Press or when the player is in the pause mode. When you find the point you want, press to return to the normal speed.

Each time you press the or button during Slow-motion play, the playback speed changes. Two speeds are available. With each press, the indication changes as follows:

Playback direction

1▶▶ ↔ 2▶▶

Opposite direction (DVD only)

1◀◀ ↔ 2◀◀

The playback speed of 2▶▶/2◀◀ is slower than 1▶▶/1◀◀.

Resuming Playback from the Point Where You Stopped the Disc (Resume Play)

The player remembers the point where you stopped the disc, and when “RESUME” appears on the front panel display, you can resume playback from that point. As long as you do not open the disc tray, Resume Play will work even if the player enters standby mode by pressing  on the remote.

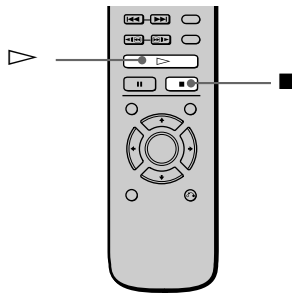
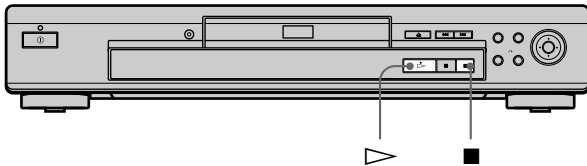

Notes

- Resume Play may not be available on some DVDs.
- Resume Play is not available in Shuffle or Program Play mode.
- Depending on where you stopped the disc, the player may resume playback from a different point.
- The point where you stopped playing is cleared when:
 - you open or close the disc tray
 - you turn the power off by pressing  on the player
 - you change the play mode
 - you start playback after selecting a title, chapter or track
 - you change the settings in the setup display

1 While playing a disc, press to stop playback.

“RESUME” appears on the front panel display and “Disc will restart from current point. To start from beginning, press  again.” appears on the TV screen.

If “RESUME” does not appear, Resume Play is not available.

2 Press .

The player starts playback from the point where you stopped the disc in Step 1.

To play from the beginning of the disc

When the playing time appears on the front panel display before you start playing, press  to reset the playing time, then press

.

Using the DVD's Menu **DVD**

Some DVDs have a title menu or a DVD menu that is provided with DVDs only.

Using the title menu

A DVD is divided into long sections of a picture or a music feature called "titles." When you play a DVD which contains several titles, you can select the title you want using the title menu.

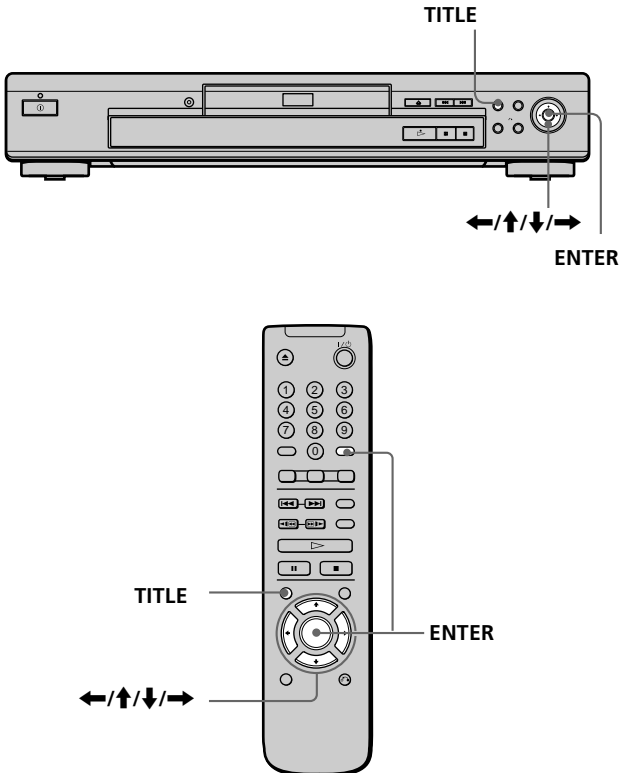

- 1 Press TITLE.**
The title menu appears on the TV screen. The contents of the menu vary from disc to disc.
- 2 Press ←/↑/↓/→ to select the title you want to play.**
Depending on the disc, you can use the number buttons to select the title.
- 3 Press ENTER.**
The player starts playing the selected title.

Notes

- On some DVDs, you may not be able to select the title.
- On some DVDs, a "title menu" may simply be called a "menu" or "title" in the instructions supplied with the disc. "Press ENTER." may also be expressed as "Press SELECT."

Using the DVD menu

Some DVDs allow you to select the disc contents using a menu. When you play these DVDs, you can select the language for the subtitles, the language for the sound, etc., using the DVD menu.

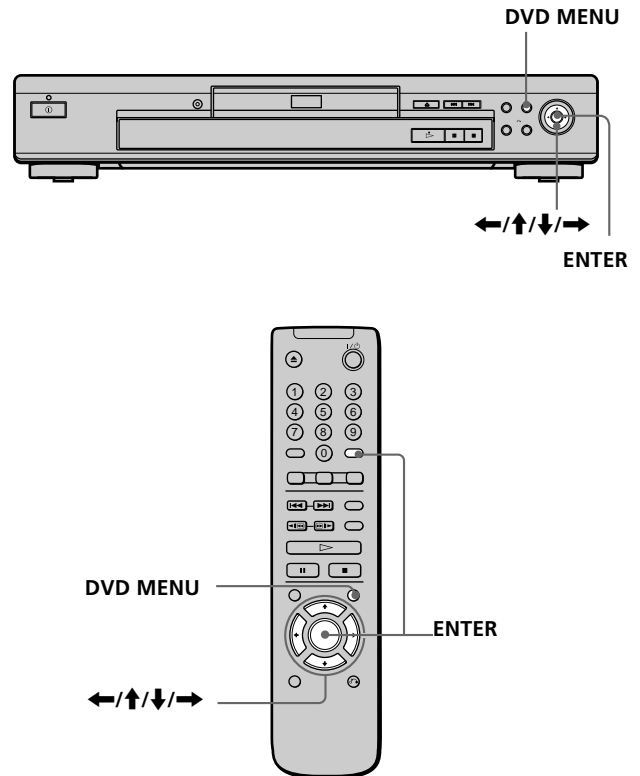

- 1 Press DVD MENU.**
The DVD menu appears on the TV screen. The contents of the menu vary from disc to disc.
- 2 Press ←/↑/↓/→ to select the item you want to change.**
Depending on the disc, you can use the number buttons to select the item.
- 3 To change other items, repeat Step 2.**
- 4 Press ENTER.**

💡 If you want to select the language for the DVD menu
Change the setting using "DVD MENU" in "LANGUAGE SETUP" in the setup display. For details, see page 49.

Note

Depending on the DVD, a "DVD menu" may simply be called a "menu" in the instructions supplied with the disc.

Playing VIDEO CDs with PBC Functions (PBC Playback)



When playing VIDEO CDs with PBC (Play Back Control) functions (Ver. 2.0 discs), you can enjoy simple interactive operations, search functions, and other such operations. PBC Playback allows you to play VIDEO CDs interactively by following the menu on the TV screen. On this player, you can use the number buttons, ENTER, ◀▶, ▶▶, ◀◀, ⬆/⬇ and ⌂RETURN during PBC Playback.

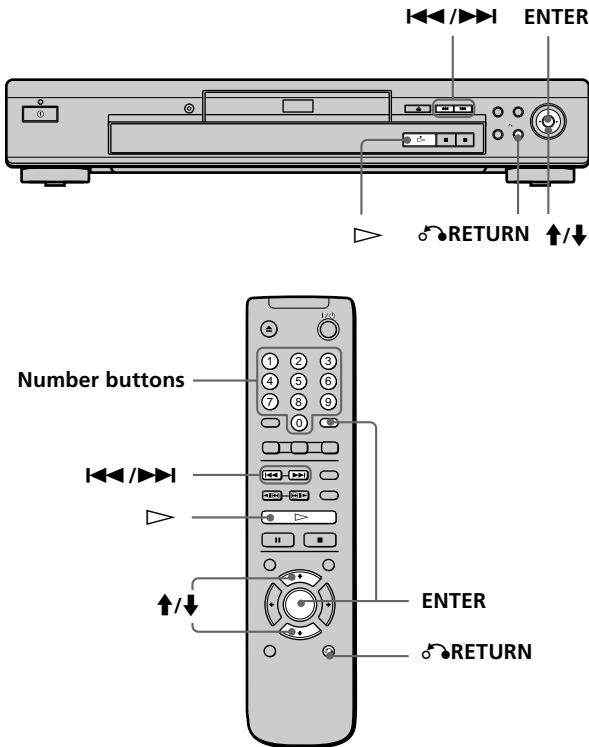

- 1 Start playing a VIDEO CD with PBC functions by following Steps 1 to 4 in "Playing Discs" on page 18.**
- 2 Select the item number you want.**
Press ⬆/⬇ to select the item number.
You can also select the item number with the number buttons on the remote.
- 3 Press ENTER.**
- 4 Follow the instructions in the menu for interactive operations.**
Refer to the instructions supplied with the disc, as the operating procedure may differ according to the VIDEO CD.

To go back to the menu

Press ⌂RETURN, ◀◀, or ▶▶.

💡 To cancel PBC playback of a VIDEO CD with PBC functions and play the disc in continuous play mode

There are two ways.

- Before you start playing, select the track you want using ◀◀ or ▶▶, then press ENTER or ▷.
- Before you start playing, select the track number using the number buttons on the remote, then press ENTER or ▷.
"Play without PBC" appears on the TV screen and the player starts continuous play. You cannot play still pictures such as a menu.
To return to PBC playback, press ■ twice then press ▷.

Note

Depending on the VIDEO CD, "Press ENTER" in Step 3 may be expressed as "Press SELECT" in the instructions supplied with the disc.

Using the Front Panel Display



You can check information about the disc, such as the total number of titles or tracks or remaining time, using the front panel display.

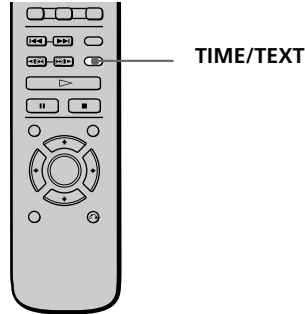

When playing back a DVD

Displaying information while playing the disc

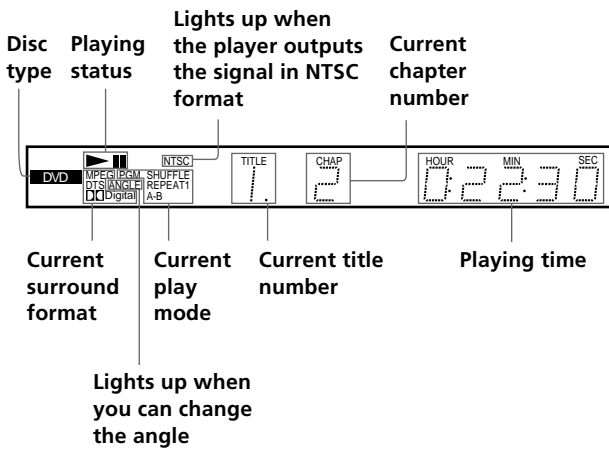

Checking the remaining time

Press TIME/TEXT.

Each time you press TIME/TEXT while playing the disc, the display changes as shown in the following chart.

Playing time and number of the current chapter

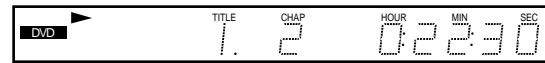

Press TIME/TEXT

Remaining time of the current chapter

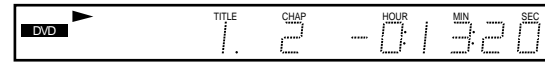

Press TIME/TEXT

Playing time and number of the current title



Press TIME/TEXT

Remaining time of the current title



Press TIME/TEXT

Text

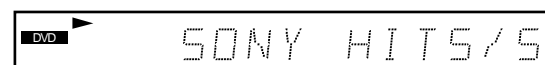

Press TIME/TEXT

Notes

- On some DVDs, the chapter number or time may not appear or you may not be able to change the front panel display.
- While you are doing Shuffle Play or Program Play, the playing time of the title and the remaining time of the title are not displayed.

When playing back a CD/VIDEO CD



Displaying information while playing a disc

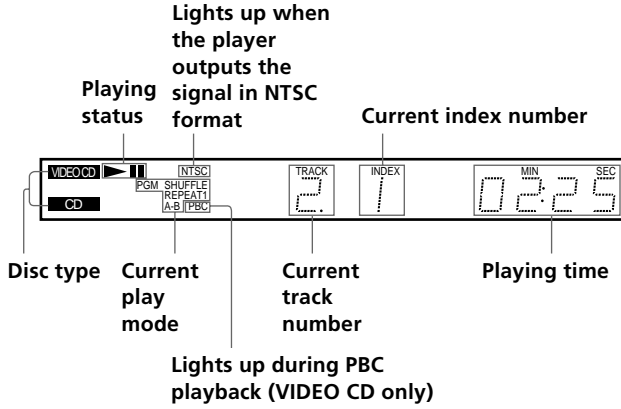

When playing VIDEO CDs with PBC functions

The current scene number is displayed instead of the current track number and the current index number. In this case, the front panel display does not change when you press TIME/TEXT. If TEXT is recorded on the disc, the front panel display changes to Text display when you press TIME/TEXT (see page 31).

Checking the remaining time

Press TIME/TEXT.

Each time you press TIME/TEXT while playing a disc, the display changes as shown in the following chart.

Playing time and current track number



Press TIME/TEXT

Remaining time of the current track



Press TIME/TEXT

Playing time of the disc

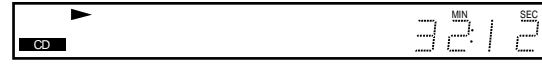

Press TIME/TEXT

Remaining time of the disc

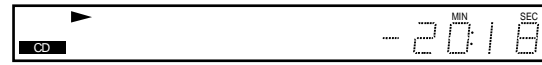

Press TIME/TEXT

Text



Press TIME/TEXT

Note

While you are doing Shuffle Play, or Program Play, the playing time of the disc and the remaining time of the disc are not displayed.

Using Various Functions with the Control Menu

This chapter describes how to play discs in various modes and how to use the convenient features of the on-screen menu (Control Menu).

Using the Control Menu Display

Using the Control Menu display, you can select the start point, play in any order you like, change the angles, make Digital Cinema Sound settings, and other such operations. The possible operations are different depending on the kind of disc.

For details on each Control Menu display item, see pages 28 to 45.

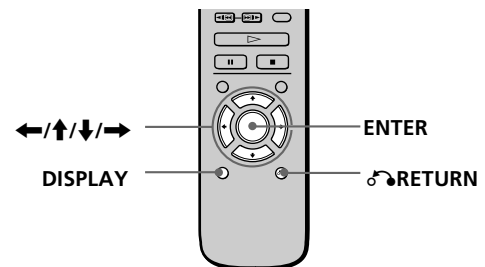
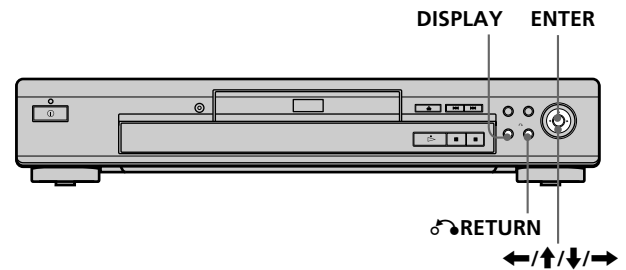

- 1 Press **DISPLAY** to show the Control Menu display on the TV screen.

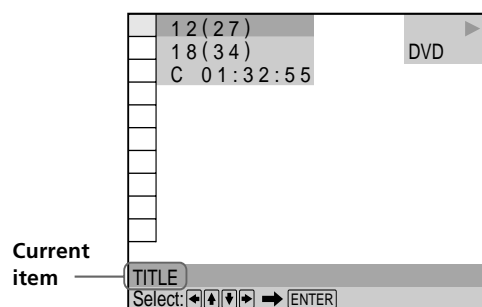

2 Select the item you want using ↑/↓.

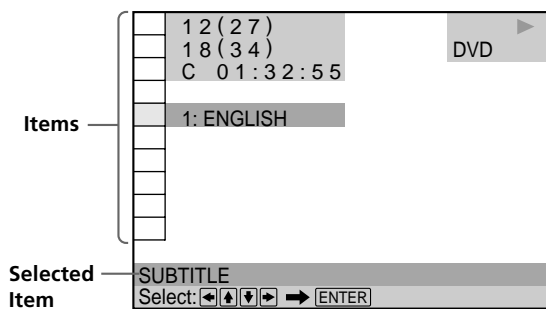

3 Press ENTER.

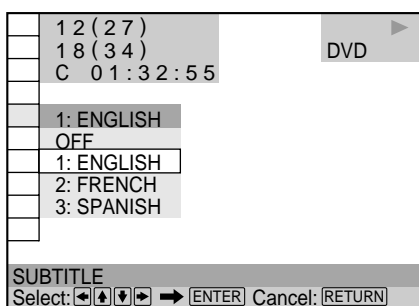

4 Select the item you want using ↑/↓.

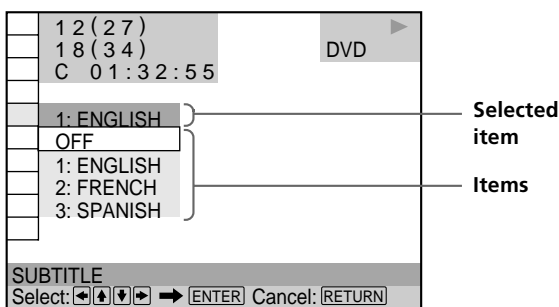

5 Press ENTER.

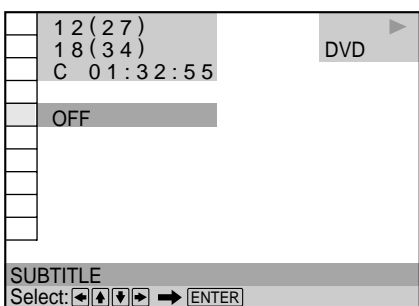

To cancel while making a selection

Press ⏪ RETURN.

To display other items

Each time you press DISPLAY, the Control Menu display changes as follows:

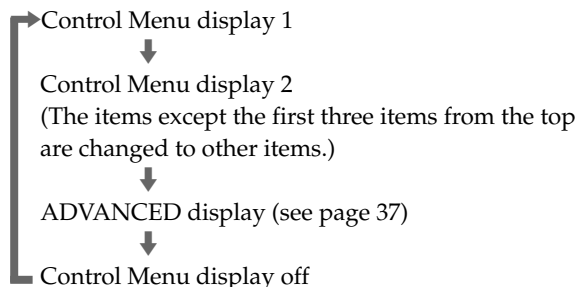

The Control Menu display items are different depending on the disc.

💡 You can select some items directly

Some items can be selected by pressing the corresponding button on the remote. In this case, only the item you selected is displayed. For instructions on using the remote, see the pages of each relevant item.

Note

Some Control Menu display items require operations other than selecting the setting. For details on these items, see the relevant pages.

Control Menu Item List

 **TITLE (DVD only) (page 29)/
SCENE (VIDEO CD during PBC playback
only) (page 29)/**

TRACK (VIDEO CD only) (page 29)

 **CHAPTER (DVD only) (page 29)/**

INDEX (VIDEO CD only) (page 29)

 **TRACK (CD only) (page 29)**

 **INDEX (CD only) (page 29)**

You can search for a point on the DVD by selecting the title, chapter, track, index or scene.

 **TIME/TEXT (pages 30, 31)**

You can check the playing time and remaining time of the current title, chapter, track and the total playing time or remaining time of the disc.

You can also search by inputting the time code.

You can check the DVD TEXT or CD TEXT of the disc on the TV screen and the front panel display.

 **AUDIO (page 32)**

If the DVD is recorded with multilingual tracks, you can select the language you want while playing the DVD.

If the DVD is recorded in multiple audio formats (PCM, Dolby Digital, MPEG or DTS), you can select the audio format you want while playing the DVD.

With multiplex CDs or VIDEO CDs, you can select the sound from the right or left channel and listen to the sound of the selected channel through both the right and left speakers.

 **SUBTITLE (DVD only) (page 34)**

With DVDs on which multilingual subtitles are recorded, you can change the subtitle language whenever you want while playing the DVD, and turn it on or off whenever you want.

 **ANGLE (DVD only) (page 35)**

With DVDs on which various angles (multi-angles) are recorded, you can change the angle of the scene.

 **VES (DVD only) (page 36)**

Select a mode to enjoy multichannel surround sound such as Dolby Digital and MPEG.

Even if you connect only front speakers, Virtual Enhanced Surround (VES) lets you enjoy 3D sound by using 3D sound imaging to create virtual rear speakers from the sound of the front speakers (L, R) without using actual rear speakers.

 **ADVANCED (DVD only) (page 37)**

You can check the play information about the bit rate or the position where the disc is played (layer).

 **CUSTOM PARENTAL CONTROL (page 38)**

Using the registered password, you can set playback restrictions for desired disc.

The same password is used for both Parental Control (page 52) and Custom Parental Control.

 **SETUP (page 46)**

Using the setup display, you can do the initial setup, adjust the picture and sound and set the various outputs. You can also set a language for the subtitles and the setup display, limit playback by children, and so on. For details about the setup display, see page 48.

 **PROGRAM (page 40)**

You can play the contents of the disc in the order you want by arranging the order of the titles, chapters or tracks on the disc to create your own program.

 **SHUFFLE (page 42)**

You can have the player “shuffle” titles, chapters or tracks and play them in a random order. Subsequent “shuffling” may produce a different playing order.

 **REPEAT (page 43)**

You can play all the titles/tracks on a disc or a single title/chapter/track repeatedly.

 **A-B REPEAT (page 44)**

You can play a specific portion of a title, chapter, or track repeatedly.

Searching for a Title/Chapter/Track/Index/Scene



You can search by selecting the title, chapter, track, index or scene.

Select "TITLE," "CHAPTER," "TRACK," "INDEX" or "SCENE" after pressing DISPLAY.

When you play back a DVD, "TITLE" and "CHAPTER" are displayed.

When you play back a VIDEO CD/CD, "TRACK" and "INDEX" are displayed. When you play back a VIDEO CD with PBC functions, "SCENE" is displayed.

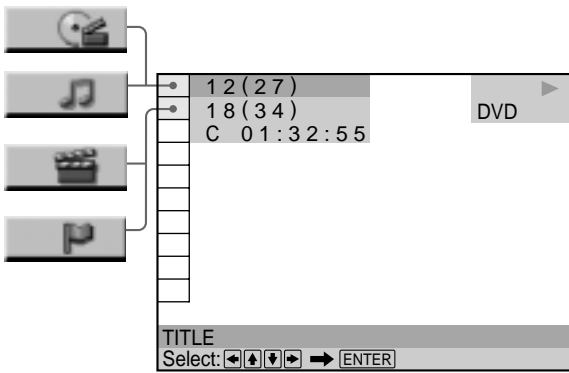

1 Select "TITLE," "CHAPTER," "TRACK," "INDEX" or "SCENE" using ↑/↓.

"** (**)" is highlighted. (** refers to a number)

The number in parentheses indicates the total number of titles, chapters, tracks, indexes or scenes.

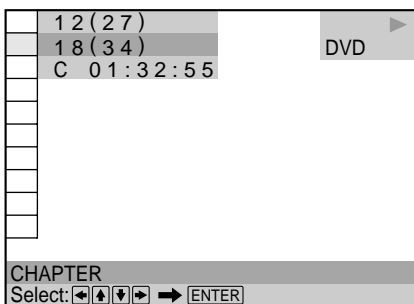

2 Press → or ENTER.

"** (**)" changes to "— — (**)".

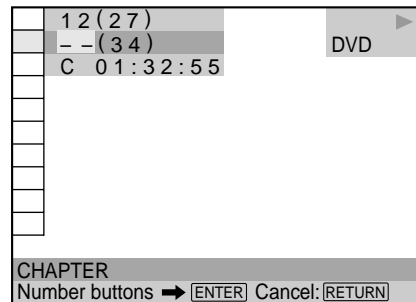

3 Select the number of the title, chapter, track, index or scene you want to search for using the number buttons, then press ENTER.

The player starts searching.

To cancel the number, press CLEAR before pressing ENTER.

To cancel while making a selection

Press ↵RETURN.

Notes

- The title, chapter or track number displayed is the same number recorded on the disc.
- The index numbers are not displayed during PBC playback of VIDEO CDs.

Checking the Playing Time and Remaining Time



DVD



VIDEO CD



CD

You can check the playing time and remaining time of the current title, chapter or track and the total playing time or remaining time of the disc.

Press DISPLAY. Then press TIME/TEXT on the remote to change the time information.

You can also check the DVD TEXT or CD TEXT. See page 31.

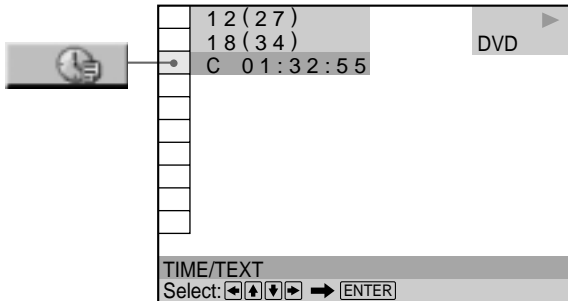

When playing a DVD

■ TIME/TEXT

- C * * * * * : Playing time of the current chapter
- C - * * * * * : Remaining time of the current chapter
- T * * * * * : Playing time of the current title
- T - * * * * * : Remaining time of the current title

When playing a VIDEO CD (during PBC playback)

■ TIME/TEXT

- * * * * * : Playing time of the current scene

When playing a VIDEO CD (in continuous play) or CD

■ TIME/TEXT

- T * * * * * : Playing time of the current track
- T - * * * * * : Remaining time of the current track
- D * * * * * : Playing time of the current disc
- D - * * * * * : Remaining time of the current disc

💡 You can select "TIME/TEXT" directly

Press TIME/TEXT on the remote. Each time you press the button, the time information changes.

Selecting a Starting Point Using the Time Code



DVD

You can search by inputting the time code.

Select "TIME/TEXT" after pressing DISPLAY.

The time code corresponds to the approximate actual playing time. For example, to search for a scene 2 hours 10 minutes 20 seconds past the beginning, input 2:10:20.

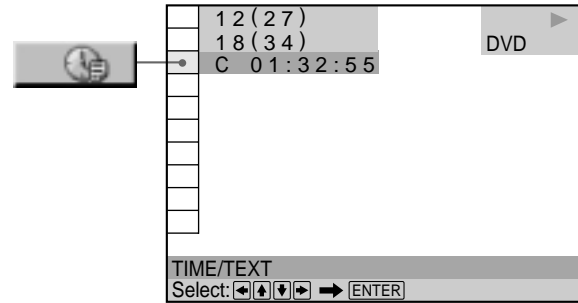

- 1 Select "C * * * * * " (playing time of the current chapter) when playing a DVD.

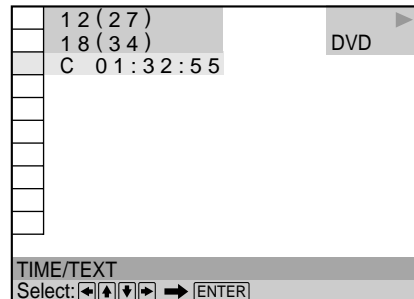

- 2 Press → or ENTER.

Time code changes to "T - - : - - : - -".

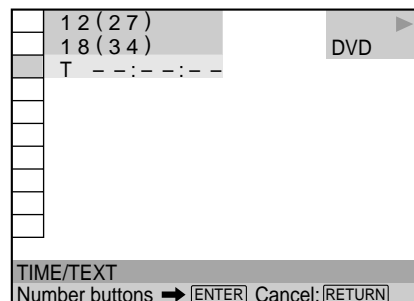

- 3** Input the time code using the number buttons, then press ENTER.

The player starts searching.

To cancel the number, press CLEAR before pressing ENTER.

To cancel while making a selection

Press  RETURN.

Note

When you input the time code, input the playing time of the title not the chapter or track time.

Viewing the Disc Information



You can check the DVD TEXT or CD TEXT of the disc on the TV screen and the front panel display.

DVD TEXT and CD TEXT are information recorded on the disc which you cannot change.

Press DISPLAY. Then press TIME/TEXT on the remote until DVD/CD TEXT is displayed.

The information is displayed at the bottom of the display.

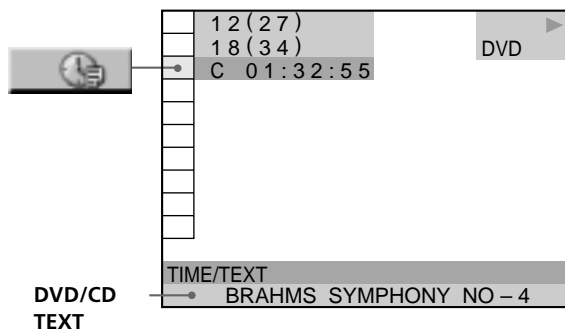

You can select "TIME/TEXT" directly

Press TIME/TEXT on the remote. To display DVD/CD TEXT, press TIME/TEXT until DVD/CD TEXT is displayed.

You can view the entire DVD/CD TEXT recorded on the disc

DVD/CD TEXT is scrolled on the front panel display.

Notes

- DVD TEXT is displayed only in English.
- "NO TEXT" appears when the DVD/CD TEXT is not recorded on the disc.
- This player can only display the first level of DVD/CD TEXT information.

Changing the Sounds

If the DVD is recorded with multilingual tracks, you can select the language you want while playing the DVD. If the DVD is recorded in multiple audio formats (PCM, Dolby Digital, MPEG or DTS), you can select the audio format you want while playing the DVD. With multiplex CDs or VIDEO CDs, you can select the sound from the right or left channel and listen to the sound of the selected channel through both the right and left speakers. In this case, the sound loses its stereo effect. For example, with a disc containing a song, the right channel may output the vocals and the left channel may output the instrumental. If you only want to hear the instrumental, you can select the left channel and hear it from both speakers.

Select "AUDIO" after pressing DISPLAY.

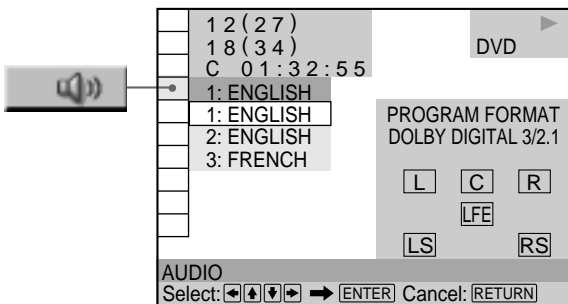

■ AUDIO

When playing a DVD

Select the language. The languages you can select are different depending on the DVD. When 4 digits are displayed, they represent the language code. Select the language code from the list on page 66.

When the same language is displayed two or more times, the DVD is recorded in multiple audio formats. The current audio format is shown on the "PROGRAM FORMAT" display.

When playing a VIDEO CD or a CD

The default setting is underlined.

- STEREO : The standard stereo sound
- 1/L : The sound of the left channel (monaural)
- 2/R : The sound of the right channel (monaural)



You can select "AUDIO" directly

Press AUDIO on the remote. Each time you press the button, the item changes.

Notes

- Depending on the DVD, you may not be able to change the languages even if multilingual tracks are recorded on the DVD.
- While playing the CD/VIDEO CD, standard stereo playback will be resumed when:
 - you open or close the disc tray
 - the player enters standby mode by pressing I/⏻ on the remote
 - you turn the power off by pressing ⏻ on the player
- While playing the DVD, the sound may be changed when:
 - you open or close the disc tray
 - you change the title

Displaying the audio information of the disc **DVD**

When you select "AUDIO," the channels being played are displayed on the screen.

In Dolby Digital format, multiple signals ranging from monaural to 5.1 channel signals can be recorded on a DVD. Depending on the DVD, the number of the recorded channels may be different.

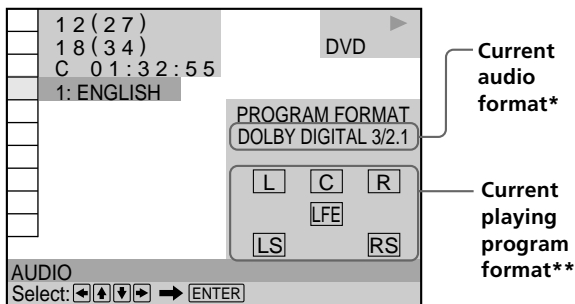

* "PCM," "DTS," "DOLBY DIGITAL" or "MPEG" is displayed. In case of "DOLBY DIGITAL," the channels in the playing track are displayed by numbers as follows:

The case of Dolby Digital 5.1 ch:

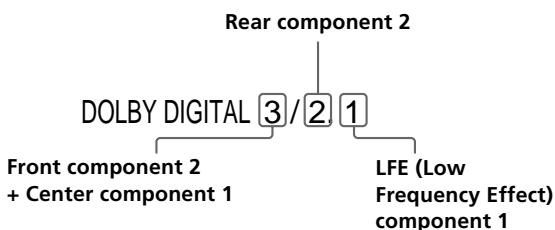

** The letters in the program format display mean the following:

- L: Front (left)
- R: Front (right)
- C: Center (monaural)
- LS: Rear (left)
- RS: Rear (right)
- S: Rear (monaural) – the rear component of the Dolby Surround processed stereo signal and the Dolby Digital signal.
- LFE: – LFE (Low Frequency Effect)

The display examples are as follows:

- PCM (stereo)

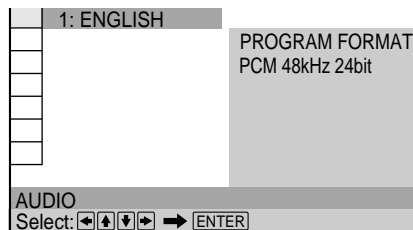

- Dolby Surround

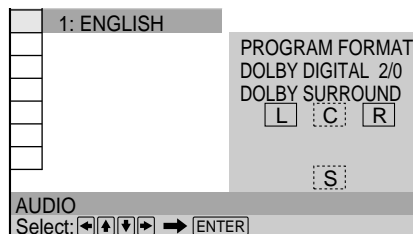

- Dolby Digital 5.1ch

"LFE" appears only when a disc contains an LFE signal component. "LFE" remains on the "PROGRAM FORMAT" display even if the LFE signal component is not being output.

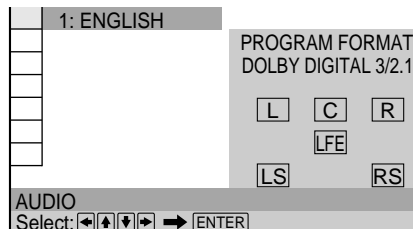

- MPEG

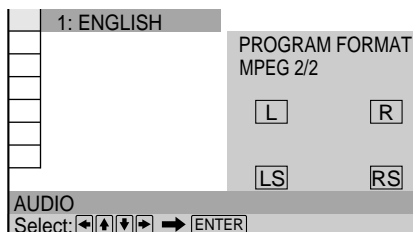

Changing the Sounds

- DTS

“LFE” is always enclosed in a solid line regardless of the LFE signal component output.

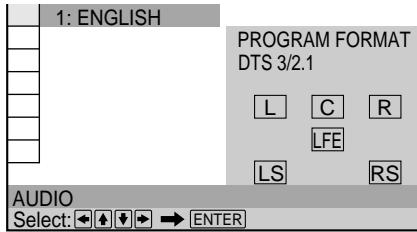

Note

When the signal does not contain rear signal components such as LS, RS or S, the Virtual Enhanced Surround (VES) effect cannot be heard (page 36).

Displaying the Subtitles



With DVDs on which subtitles are recorded, you can turn the subtitles on and off whenever you want while playing the DVD.

With DVDs on which multilingual subtitles are recorded, you can change the subtitle language whenever you want while playing the DVD, and turn it on or off whenever you want. For example, you can select the language you want to practice and turn the subtitles on for better understanding.

Select “SUBTITLE” after pressing DISPLAY.

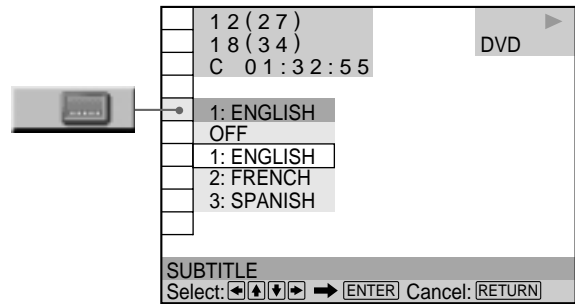

■ SUBTITLE

Select the language. The languages you can select are different depending on the DVD. When 4 digits are displayed, they indicate the language code. Select the language code from the list on page 66.

You can select “SUBTITLE” directly

Press SUBTITLE on the remote. Each time you press the button, the item changes.

Notes

- When playing a DVD on which no subtitles are recorded, no subtitles appear.
- Depending on the DVD, you may not be able to turn the subtitles on even if they are recorded on the DVD.
- Depending on the DVD, you may not be able to turn the subtitles off.
- The type and number of languages for subtitles vary from disc to disc.
- Depending on the DVD, you may not be able to change the subtitles even if multilingual subtitles are recorded on it.
- While playing the DVD, the subtitle may change when:
 - you open or close the disc tray
 - you change the title

Changing the Angles

With DVDs on which various angles (multi-angles) for a scene are recorded, you can change the angles. For example, while playing a scene of a train in motion, you can display the view from either the front of the train, the left window of the train or from the right window without having the train's movement interrupted.

Select "ANGLE" after pressing DISPLAY. When the angles can be changed, the "ANGLE" indicator lights up in green.

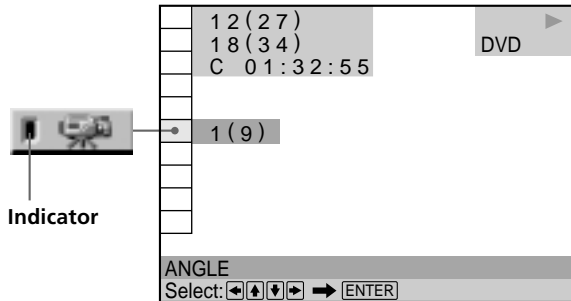

1 Select "ANGLE."

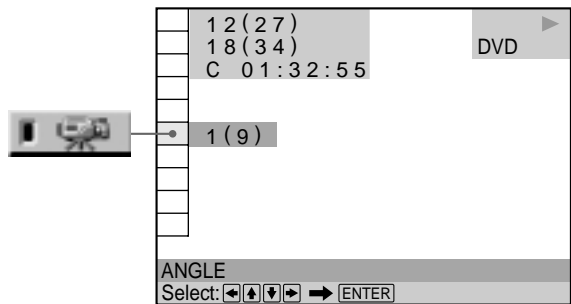

2 Press →.

The number of the angle changes to "-". The number in parentheses indicates the total number of angles.

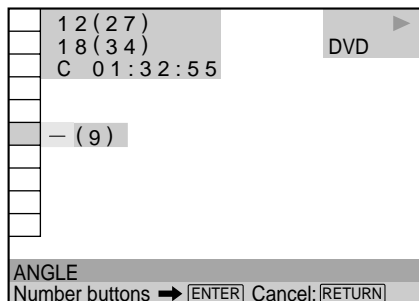

3 Select the number of the angles using the number buttons or ↑/↓, then press ENTER.

The angle is changed to the selected angle.

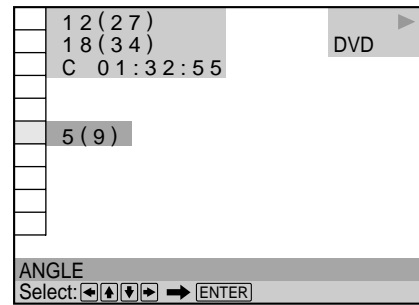

You can select "ANGLE" directly

Press ANGLE on the remote. Each time you press the button, the angle changes.

Notes

- The number of angles varies from disc to disc or from scene to scene. The number of angles that can be changed on a scene is equal to the number of angles recorded for that scene.
- Depending on the DVD, you may not be able to change the angles even if multi-angles are recorded on the DVD.

Digital Cinema Sound Settings

Select a mode to enjoy multichannel surround sound such as Dolby Digital and MPEG.

Even if you connect only a TV, front speakers or use a 2+1 channel connection, Virtual Enhanced Surround (VES) lets you enjoy 3D sound by using 3D sound imaging to create virtual rear speakers from the sound of the front speakers (L:left, R:right) without using actual rear speakers.

The surround sound signals are output from the AUDIO OUT connectors.

When you select a surround mode, the player does not output the following signals from the DIGITAL OUT OPTICAL or COAXIAL connector.

- Dolby Digital signals (when you set "DOLBY DIGITAL" in "AUDIO SETUP" to "D-PCM")
- MPEG AUDIO signals

Select "VES" after pressing DISPLAY. When you select any item except "OFF," the "VES" indicator lights up in green.

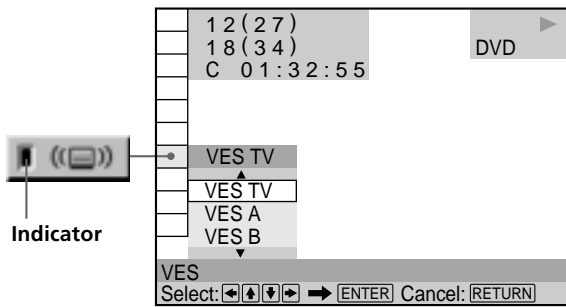

■ VES

Select the desired item. For details on each item, see "Effects of each item."

The default setting is underlined.

- OFF
- VES TV
- VES A
- VES B
- VIRTUAL SEMI MULTI DIMENSION

Effects of each item

OFF

Outputs 2-channel signals for stereo sound. 5-channel signals for Dolby Digital sound of a DVD are mixed down to 2-channels.



VES (Virtual Enhanced Surround) TV

Uses 3D sound imaging to create virtual rear speakers from the sound of the front speakers (L, R) without using actual rear speakers. This mode is effective when the distance between the front L and R speakers is short, such as built-in TV speakers.



VES (Virtual Enhanced Surround) A

Uses 3D sound imaging to create virtual rear speakers from the sound of the front speakers (L, R) without using actual rear speakers. The virtual speakers are reproduced as shown in the illustration below.



VES (Virtual Enhanced Surround) B

Uses 3D sound imaging to create virtual rear speakers from the sound of the front speakers (L, R) without using actual rear speakers. The virtual speakers are reproduced as shown in the illustration below.



VIRTUAL SEMI MULTI DIMENSION

Uses 3D sound imaging to create virtual rear speakers from the sound of the front speakers (L, R) without using actual rear speakers. This mode creates 5 sets of virtual speakers surrounding the listener at a 30° angle of elevation.

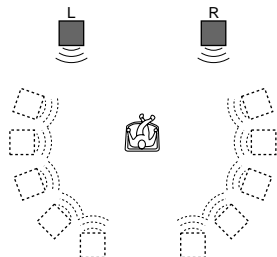

You can select "VES" directly

Press VES on the player. Each time you press the button, the item changes.

Notes

- When you select an item, the sound cuts off for a moment.
- When the playing signal does not contain the surround component, the effects may be difficult to hear even if you select "VES TV," "VES A," "VES B" or "VIRTUAL SEMI MULTI DIMENSION."
- Set the front speakers to form an equilateral triangle with the listening position at the top, or the effects may be difficult to hear even if you select "VES A," "VES B" or "VIRTUAL SEMI MULTI DIMENSION."
- When you select "VES TV," "VES A," "VES B" or "VIRTUAL SEMI MULTI DIMENSION," set the surround settings of the connected units, such as the amplifier, to OFF.

Checking the Play Information

You can check information such as the bit rate or the disc layer that is being played.

While playing a disc, the approximate bit rate of the playback picture is always displayed as Mbps (Mega bit per second) and the audio as kbps (kilo bit per second).

Select "ADVANCED" after pressing DISPLAY.

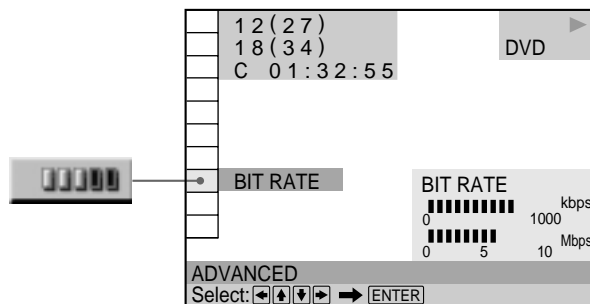

■ ADVANCED

The default setting is underlined.

When playing a DVD

- BIT RATE: displays the bit rate.
- LAYER: displays the layer and the point picked up.
- OFF: turns off ADVANCED display.

Checking the Play Information

Displays of each item

By pressing DISPLAY repeatedly, you can display either "BIT RATE" or "LAYER," whichever was selected in "ADVANCED."

BIT RATE

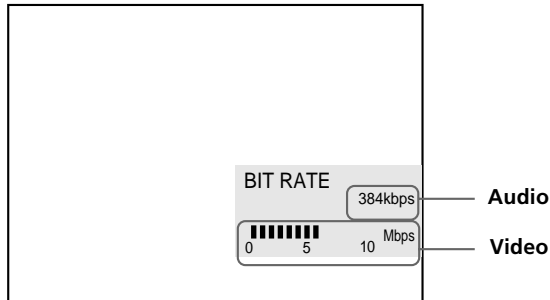

When you play MPEG AUDIO sound tracks

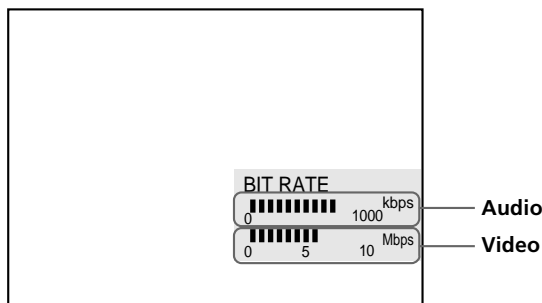

Bit rate refers to the amount of video/audio data per second in a disc. The higher the bit rate, the larger the amount of data. When the bit rate level is high, there is a large amount of data. However, this does not always mean that you can get higher quality pictures or sounds.

LAYER



Appears when the DVD has dual layers

Indicates the approximate point where the disc is playing. If it is a dual-layer DVD, the player indicates which layer is being read ("Layer 0" or "Layer 1"). For details on the layers, see page 64 (DVD).

Locking Discs (Custom Parental Control)



Using the registered password, you can set playback restrictions for desired disc.

You can set the Custom Parental Control up to 50 discs. When you set to the fifty-first disc, the first disc setting is canceled.

The same password is used for both Parental Control (page 52) and Custom Parental Control.

Select "CUSTOM PARENTAL CONTROL" after pressing DISPLAY.

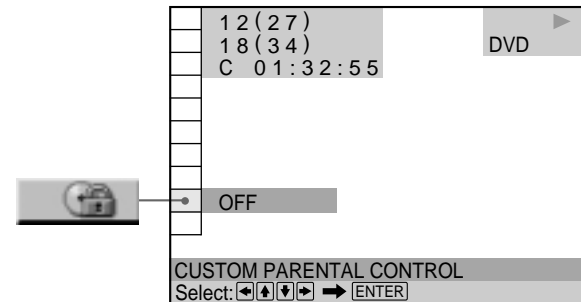

Setting the Custom Parental Control to a disc

- 1 Insert the disc you want to lock.
If a disc is playing, press ■ to stop playback.
- 2 Select "CUSTOM PARENTAL CONTROL" using ↑/↓, then press ENTER.

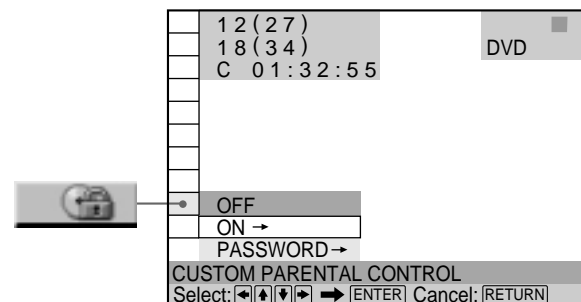

3 Select "ON→" using ↑/↓, then press ENTER.

■ If you have not entered a password

The display for entering a password appears.

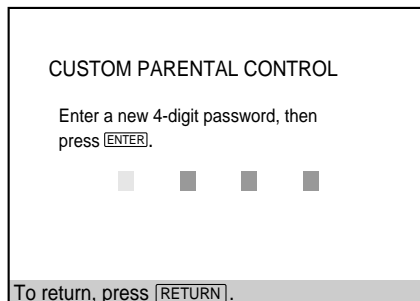

■ When you have already registered a password

The display for confirming the password appears. Skip Step 4.

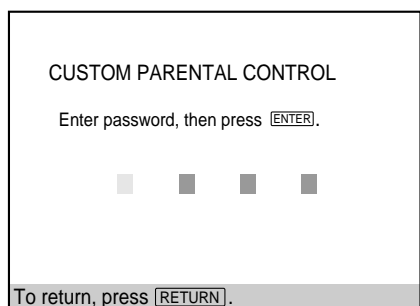

4 Enter a 4-digit password using the number buttons, then press ENTER.

The digits change to asterisks (*), and the display for confirming the password appears.

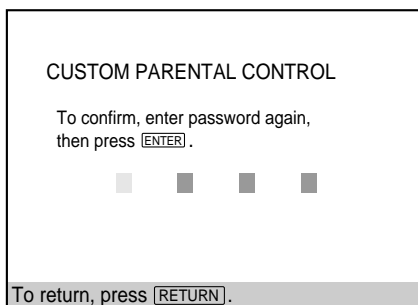

5 Enter the same 4-digit password using the number buttons, then press ENTER.

"Custom parental control is set." appears and then the screen returns to the Control Menu display.

To return to the normal screen

Press ⏪RETURN.

To turn off the Custom Parental Control function

- 1 Select "CUSTOM PARENTAL CONTROL" using ↑/↓, then press ENTER.
- 2 Select "OFF" using ↑/↓, then press ENTER.
- 3 Enter your 4-digit password using the number buttons, then press ENTER.

To change the password

- 1 Select "CUSTOM PARENTAL CONTROL" using ↑/↓, then press ENTER.
- 2 Select "PASSWORD→" using ↑/↓, then press ENTER.
- 3 Enter your 4-digit password using the number buttons, then press ENTER.
The display for changing the password appears.
- 4 Enter a new 4-digit password using the number buttons, then press ENTER.
- 5 To confirm your password, re-enter it using the number buttons, then press ENTER.

Playing the disc on which the Custom Parental Control is set

1 Insert the disc.

The CUSTOM PARENTAL CONTROL display appears.

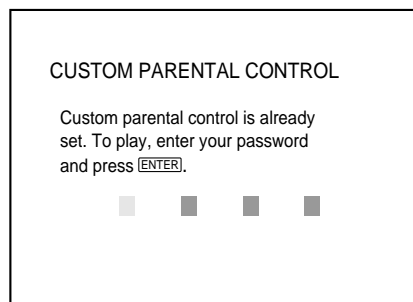

2 Enter your 4-digit password using the number buttons, then press ENTER.

The player starts playback.

💡 If you forget your password

Enter the 6-digit number "199703" in Step 2 to clear the current password. To enter a new password, follow the "Setting the Custom Parental Control to a disc" procedure.

Note

Unless you enter the password, the player cannot play the disc on which the Custom Parental Control is set. When you do not know the password, press ⏪ and remove the disc.

Creating Your Own Program (Program Play)



You can play the contents of the disc in the order you want by arranging the order of the titles, chapters or tracks on the disc and create your own program. One program can be stored in the player and contain up to 99 titles, chapters and tracks.

Select "PROGRAM" after pressing DISPLAY. When you select "ON," the "PROGRAM" indicator lights up in green.

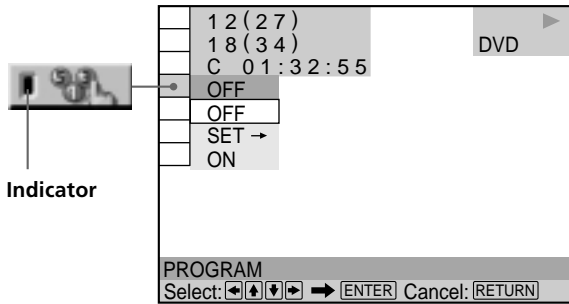

Using Various Functions with the Control Menu

PROGRAM

The default setting is underlined.

- OFF: plays normally.
- SET →: allows you to create your own program.
- ON: plays Program Play.

Creating the program

1 Select "SET →" in "PROGRAM."

The programming display appears.

"TRACK" is displayed when you play a VIDEO CD or a CD.

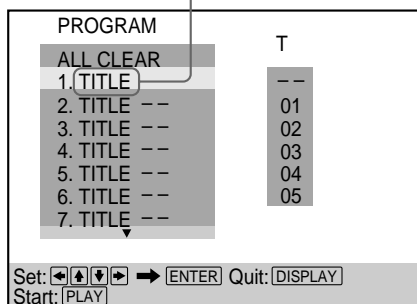

2 Press →.

"01" is highlighted. It is ready to set the first title or track for Program Play.

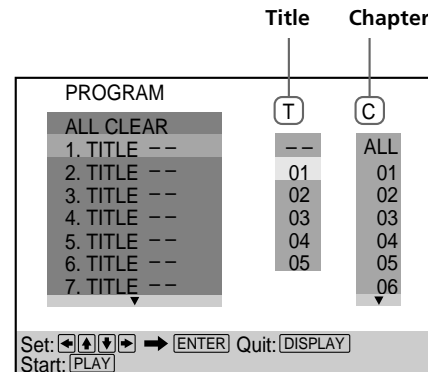

3 Select the title, chapter or track you want to program using ↑/↓, then press ENTER.

For example, select title or track 2.

(You can also use the number buttons and ENTER button to make a selection. In this case, the selected number is displayed on the screen.)

When playing a DVD

When both titles and chapters are recorded on the disc, select the title, then the chapter.

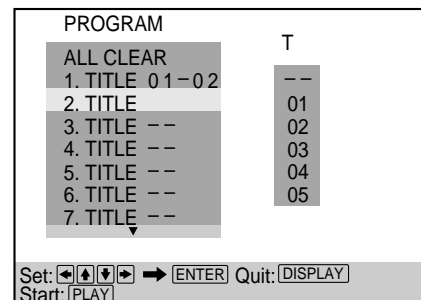
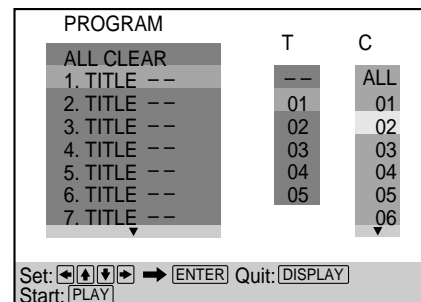

- **When playing a VIDEO CD or CD**
Select the track you want to program.

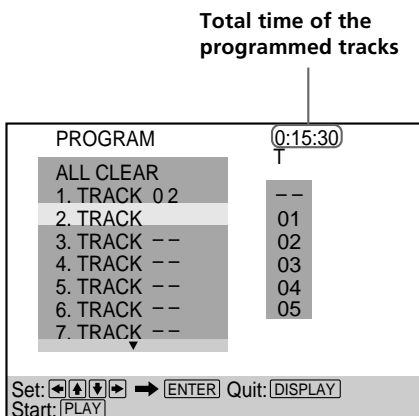

- 4 To program other titles, chapters or tracks, repeat Step 3.**

The programmed titles, chapters or tracks are displayed in the selected order.

- 5 Press \triangleright to start Program Play.**

To stop Program Play

Press CLEAR on the remote.

To change the program

- In Step 2, select the program number of the title, chapter or track you want to change using \uparrow/\downarrow .
- Follow Step 3 for new programming.

To cancel the programmed order

To cancel all the titles, chapters or tracks in the programmed order, select "ALL CLEAR" in Step 2. To cancel the selected program, select the program using \uparrow/\downarrow in Step 2 then press CLEAR, or select "--" in Step 3 then press ENTER.

💡 The program remains even after Program Play ends

When you press \triangleright , you can play the same program again.

💡 You can do Repeat Play or Shuffle Play of the programmed titles, chapters or tracks

During Program Play, set "REPEAT" or "SHUFFLE" to "ON" in the Control Menu display.

💡 You can select discs, titles, chapters and tracks for the program by looking at the front panel display

You can program by looking at the front panel display instead of using the programming display on the TV screen.

When you select Track 3 in a VIDEO CD for Program 1, the front panel display will appear as follows:

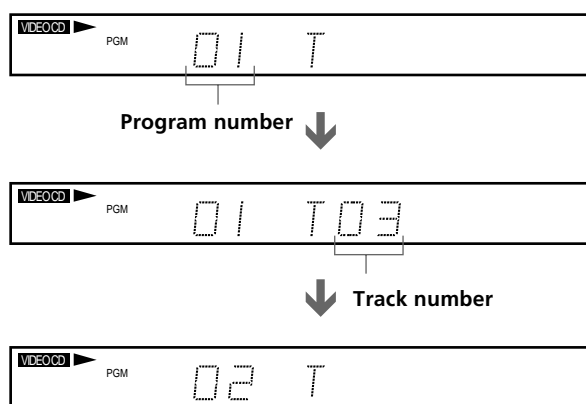

Notes

- The number of titles, chapters or tracks displayed are the same number of titles, chapters or tracks recorded on a disc.
- The program is canceled when:
 - you open or close the disc tray
 - the player enters standby mode by pressing \mathbb{I}/\mathbb{O} on the remote
 - you turn the power off by pressing \mathbb{O} on the player
- You may not be able to perform Program Play depending on the DVD.
- If you are using the PBC playback function, you must first stop the disc before you can set a program.

Playing in Random Order (Shuffle Play)

You can have the player “shuffle” titles or tracks and play them in a random order. The playing order may differ from the previous “shuffling.”

Select “SHUFFLE” after pressing DISPLAY. When you select a shuffle mode other than “OFF,” the “SHUFFLE” indicator lights up in green.

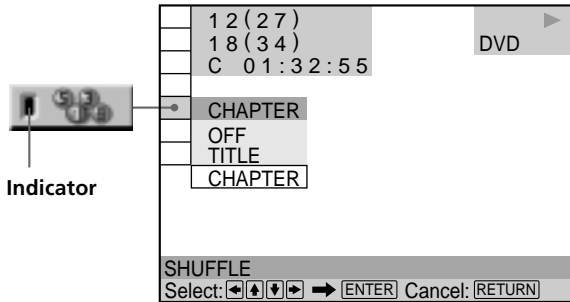

■ SHUFFLE

Selects the Shuffle Play setting.
The default settings are underlined.

When playing a DVD and when Program Play is set to OFF

- OFF: does not play a disc in random order.
- TITLE: has the player “shuffle” titles and play them in a random order.
- CHAPTER: has the player “shuffle” chapters and play them in a random order.

When playing a VIDEO CD, CD or DVD (when Program Play is set to ON)



- OFF: does not play a disc in random order.
- ON: has the player “shuffle” titles or tracks and play them in a random order.

When playing a VIDEO CD or CD (when Program Play is set to OFF)



- OFF: does not play a disc in random order.
- TRACK: has the player “shuffle” tracks and play in a random order.

To stop Shuffle Play

Press CLEAR on the remote.

 **You can set Shuffle Play while the disc is stopped**
After selecting the “SHUFFLE” option, press .
The player starts Shuffle Play.

Notes

- Shuffle Play is canceled when:
 - you open or close the disc tray
 - the player enters standby mode by pressing  on the remote
 - you turn the power off by pressing  on the player
- You may not be able to perform Shuffle Play depending on the DVD.
- Up to 200 chapters in a disc can be played in random order when “CHAPTER” is selected.

Playing Repeatedly (Repeat Play)

You can play all of the titles or tracks on a disc or a single title, chapter or track repeatedly.
In Shuffle or Program Play mode, the player repeats the titles or tracks in the shuffled or programmed order.
You cannot perform Repeat Play during PBC playback of VIDEO CDs (page 23).

Select "REPEAT" after pressing DISPLAY. When you select a repeat mode other than "OFF," the "REPEAT" indicator lights up in green.

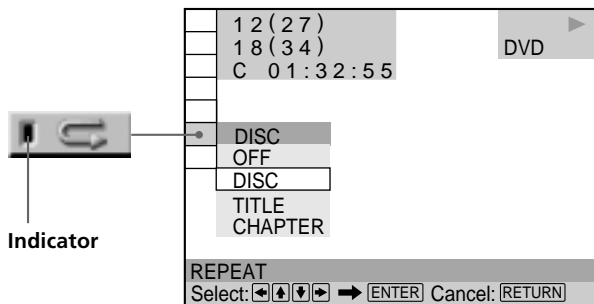

■ REPEAT

Selects the Repeat Play setting.
The default settings are underlined.

When playing a DVD and when Program Play and Shuffle Play are set to OFF

- OFF: does not play repeatedly.
- DISC: repeats all of the titles.
- TITLE: repeats the current title on a disc.
- CHAPTER: repeats the current chapter.

When playing a VIDEO CD/CD and when Program Play and Shuffle Play are set to OFF



- OFF: does not play repeatedly.
- DISC: repeats all of the tracks on a disc.
- TRACK: repeats the current track.

When Program Play or Shuffle Play is set to ON



- OFF: does not play repeatedly.
- ON: repeats Program Play or Shuffle Play.

To stop Repeat Play

Press CLEAR on the remote.

 **You can set Repeat Play while the disc is stopped**
After selecting the "REPEAT" option, press .
The player starts Repeat Play.

Notes

- Repeat play is canceled when:
 - you open or close the disc tray
 - the player enters standby mode by pressing  on the remote
 - you turn the power off by pressing  on the player
- You may not be able to perform Repeat Play depending on the DVD.

Repeating a Specific Portion (A-B Repeat)

You can play a specific portion of a title, chapter or track repeatedly. This function is useful when you want to do such things as memorize lyrics.

During PBC Playback of VIDEO CDs (page 23), this function is available only while playing moving pictures.

Select "A-B REPEAT" after pressing DISPLAY. During A-B Repeat Play, the "A-B REPEAT" indicator lights up in green.

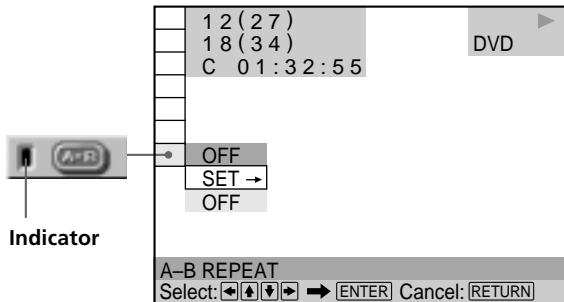

■ A-B REPEAT

The default setting is underlined.

- SET ->: sets the A and B points.
- OFF: does not play a specific portion of a title/chapter/track repeatedly.

Setting a portion for A-B repeat

1 Select "SET ->" in "A-B REPEAT."

The A-B REPEAT setting display appears.

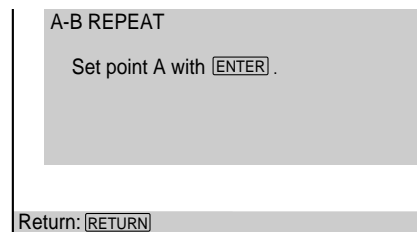
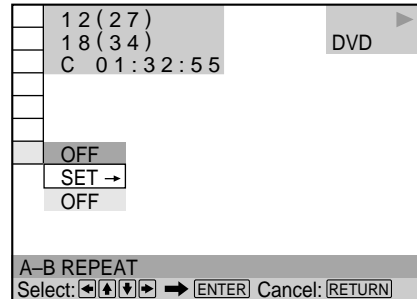

2 During playback, when you find the starting point (point A) of the portion to be played repeatedly, press ENTER.

The starting point (point A) is set.

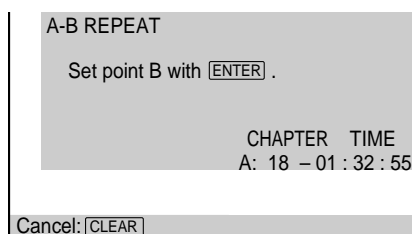

3 When you reach the ending point (point B), press ENTER again.

The set points are displayed and the player starts repeating this specific portion.

“A-B” appears on the front panel display during A-B repeat play.

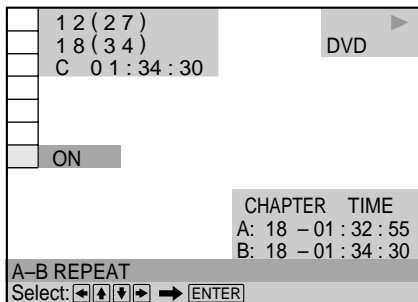

To stop A-B Repeat Play

Press CLEAR on the remote.

Notes

- You can set A-B Repeat for only one specific portion.
- A-B Repeat is canceled when:
 - you open or close the disc tray
 - the player enters standby mode by pressing I/⏻ on the remote
 - you turn the power off by pressing ⏻ on the player
- When you set A-B Repeat, the settings for Shuffle Play and Program Play are canceled.
- You may not be able to set A-B Repeat for some DVD or VIDEO CD scenes.

Settings and Adjustments

This chapter describes how to set and adjust the player using the on-screen setup menu. Most settings and adjustments are required to be set when you first use the player.

Using the Setup Display



Using the setup display, you can do the initial setup, adjust the picture and sound and set the various outputs. You can also set a language for the subtitles and the setup display, limit playback by children, and so on. For details on each setup display item, see pages 48 to 58.

Note

You can display the setup display only when the player is in stop mode.

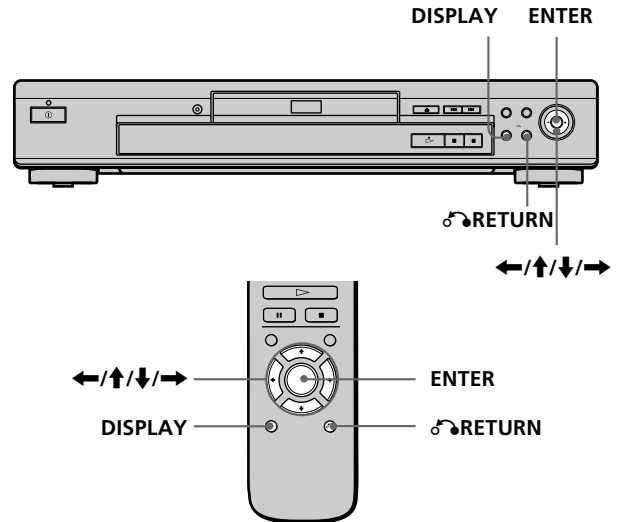

- 1 Press DISPLAY and select "SETUP" using ↑/↓.

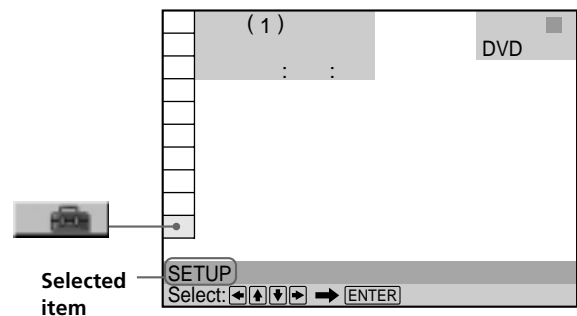

- 2 Press ENTER.

The setup display appears.

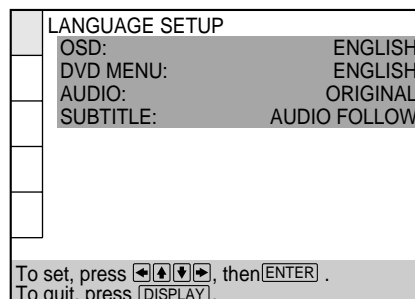

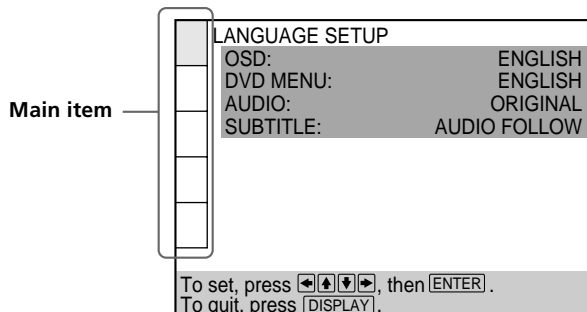
3 Select the main item you want using **↑/↓**.**4** Press **ENTER**.

The selected main item is highlighted.

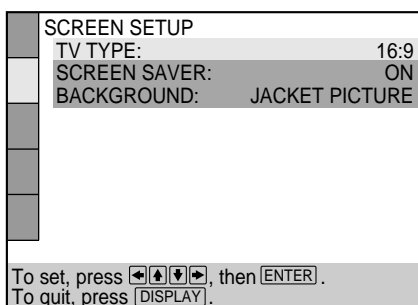
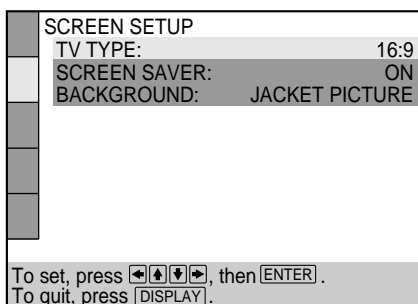
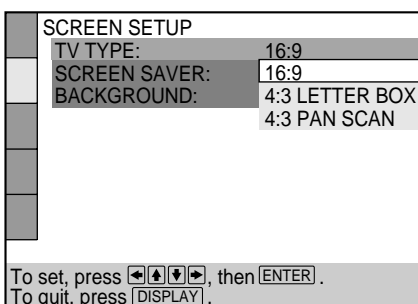
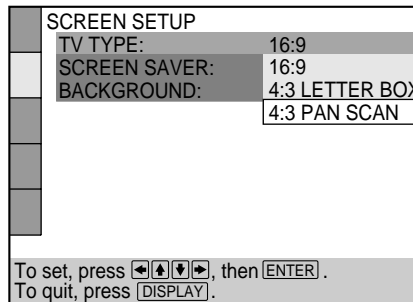
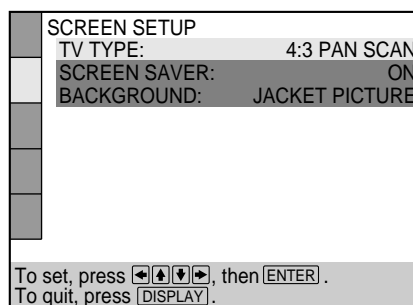
**5** Select the item you want using **↑/↓**.**6** Press **ENTER**.**7** Select the setting you want using **←/↑/↓/→**.**8** Press **ENTER**.**9** Press **DISPLAY**.

The setup display disappears.

10 Press **DISPLAY** repeatedly to turn off the on-screen menu.**To return to the previous screen**

Press **↶** RETURN.

To quit while making a selection

Press **DISPLAY**.

Note

Some setup display items require operations other than selecting the setting. For details on these items, see the relevant pages.

Setup Display Item List

The default settings are underlined.

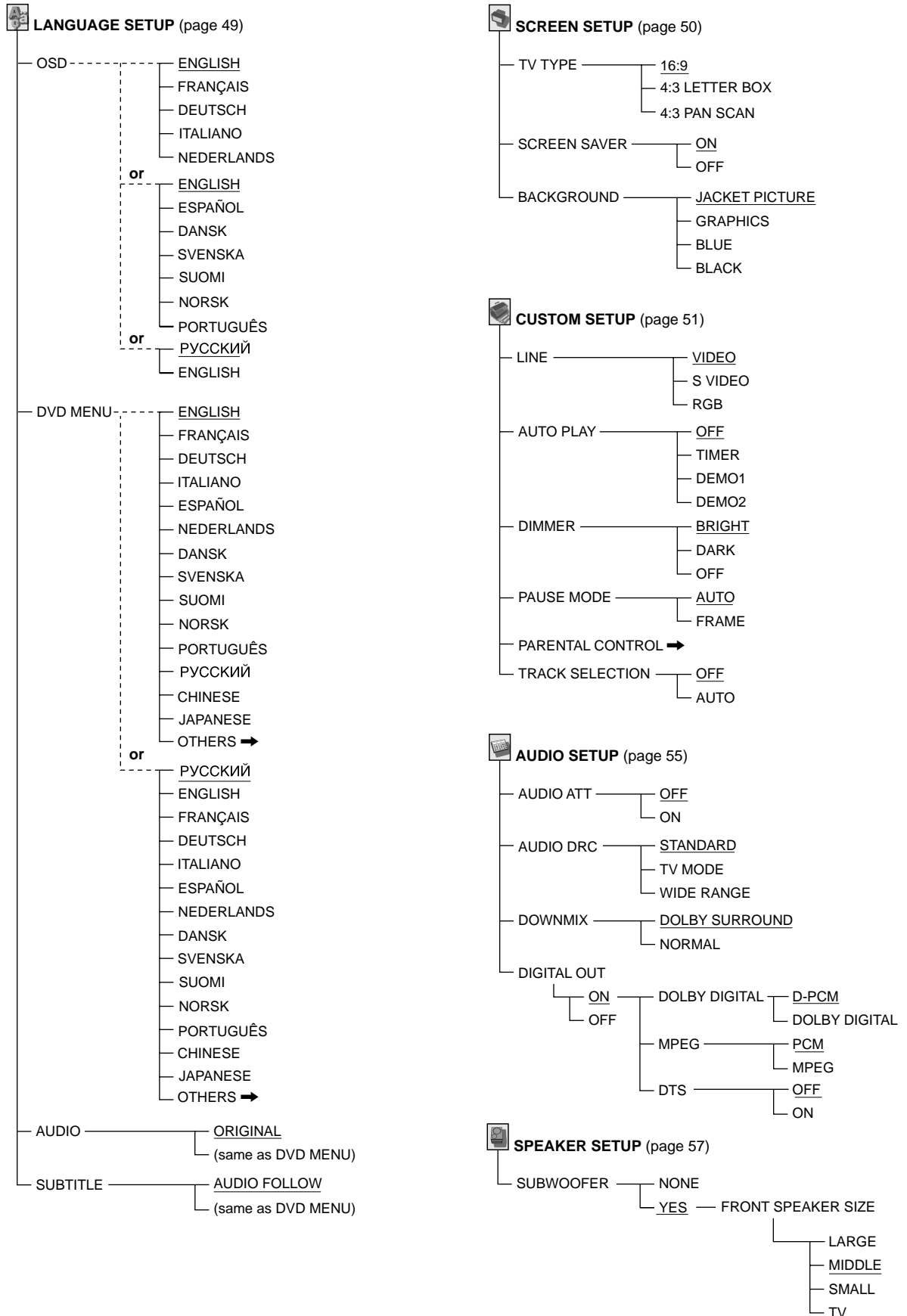

Setting the Display Language or Sound Track (LANGUAGE SETUP)

“LANGUAGE SETUP” allows you to set various languages for the on-screen display or sound track. The default settings are underlined.

Select “LANGUAGE SETUP” in the setup display.

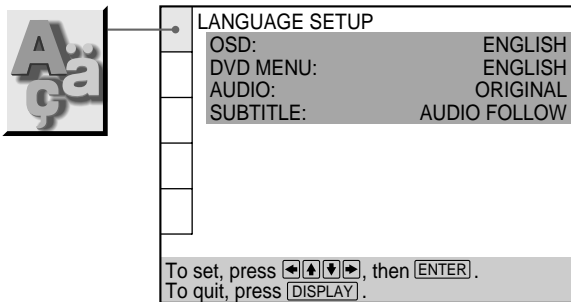

Notes

- When you select a language that is not recorded on the DVD, one of the recorded languages is automatically selected for the “DVD MENU,” “AUDIO” and “SUBTITLE” settings.
- Even when you select a language in “DVD MENU,” “AUDIO” or “SUBTITLE,” the player may not start playing with the selected language depending on the DVD.

■ OSD (On-Screen Display)

Selects the language for the on-screen display. The languages you can select are different depending on the player model.

Type A

- ENGLISH (English)
- FRANÇAIS (French)
- DEUTSCH (German)
- ITALIANO (Italian)
- NEDERLANDS (Dutch)

Type B

- ENGLISH (English)
- ESPAÑOL (Spanish)
- DANSK (Danish)
- SVENSKA (Swedish)
- SUOMI (Finnish)
- NORSK (Norwegian)
- PORTUGUÊS (Portuguese)

Type C

- РУССКИЙ (Russian)
- ENGLISH (English)

■ DVD MENU

Selects the language for the DVD menu. The language order is different depending on the player model. Default setting is “ENGLISH” or “РУССКИЙ.”

- ENGLISH (English)
- FRANÇAIS (French)
- DEUTSCH (German)
- ITALIANO (Italian)
- ESPAÑOL (Spanish)
- NEDERLANDS (Dutch)
- DANSK (Danish)
- SVENSKA (Swedish)
- SUOMI (Finnish)
- NORSK (Norwegian)
- PORTUGUÊS (Portuguese)
- РУССКИЙ (Russian)
- CHINESE (Chinese)
- JAPANESE (Japanese)
- OTHERS➡

When you select “OTHERS➡,” select and enter the language code from the list using the number buttons (page 66). After you have made a selection, the language code (4 digits) is displayed.

■ AUDIO

Selects the language for the sound track. The language order is different depending on the player model.

- ORIGINAL: the language given priority in the disc
- ENGLISH (English)
- FRANÇAIS (French)
- DEUTSCH (German)
- ITALIANO (Italian)
- ESPAÑOL (Spanish)
- NEDERLANDS (Dutch)
- DANSK (Danish)
- SVENSKA (Swedish)
- SUOMI (Finnish)
- NORSK (Norwegian)
- PORTUGUÊS (Portuguese)
- РУССКИЙ (Russian)
- CHINESE (Chinese)
- JAPANESE (Japanese)
- OTHERS➡

When you select “OTHERS➡,” select and enter the language code from the list using the number buttons (page 66). After you have made a selection, the language code (4 digits) is displayed.

Setting the Display Language or Sound Track (LANGUAGE SETUP)

■ SUBTITLE

Selects the language for the subtitles. The language order is different depending on the player model.

- AUDIO FOLLOW*
- ENGLISH (English)
- FRANÇAIS (French)
- DEUTSCH (German)
- ITALIANO (Italian)
- ESPAÑOL (Spanish)
- NEDERLANDS (Dutch)
- DANSK (Danish)
- SVENSKA (Swedish)
- SUOMI (Finnish)
- NORSK (Norwegian)
- PORTUGUÊS (Portuguese)
- РУССКИЙ (Russian)
- CHINESE (Chinese)
- JAPANESE (Japanese)
- OTHERS →

When you select "OTHERS →," select and enter the language code from the list using the number buttons (page 66).

After you have made a selection, the language code (4 digits) is displayed.

- * When you select "AUDIO FOLLOW," the language for the subtitles changes according to the language for the setting you selected in "AUDIO."

Settings for the Display (SCREEN SETUP)



"SCREEN SETUP" allows you to set the display according to the playback conditions.

The default settings are underlined.

Select "SCREEN SETUP" in the setup display.

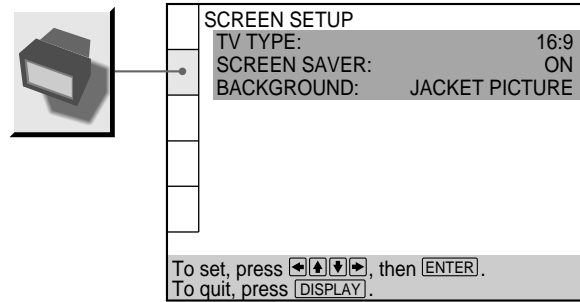

■ TV TYPE

Selects the aspect ratio of the TV to be connected.

- 16:9: select this when you connect a wide-screen TV to the player.
- 4:3 LETTER BOX: select this when you connect a normal TV to the player. Displays a wide picture with bands on the upper and lower portions of the screen.
- 4:3 PAN SCAN: select this when you connect a normal TV to the player. Displays the wide picture on the whole screen automatically and cuts off the portions that do not fit.

16:9

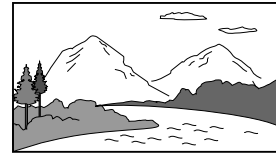

4:3 LETTER BOX



4:3 PAN SCAN

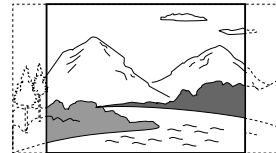

Note

Depending on the DVD, "4:3 LETTER BOX" may be selected automatically instead of "4:3 PAN SCAN" and vice versa.

■ SCREEN SAVER

Turns on and off the screen saver. If you turn on the screen saver, the screen saver image appears when you leave the player or the remote in pause or stop mode for 15 minutes or when you play back a CD for more than 15 minutes. The screen saver will help prevent your display device from becoming damaged.

- ON: turns on the screen saver.
- OFF: turns off the screen saver.

■ BACKGROUND

Selects the background color or picture of the TV screen in stop mode or while playing a CD.

- JACKET PICTURE: The jacket picture appears in the background, but only when the jacket picture is already recorded on the disc.
- GRAPHICS: A preset picture stored in the player appears in the background.
- BLUE: The background color is blue.
- BLACK: The background color is black.

Note

If a disc which does not contain the jacket picture is played while "BACKGROUND" is set to "JACKET PICTURE," the picture stored in the player will automatically appear in the background.

Custom Settings (CUSTOM SETUP)



"CUSTOM SETUP" allows you to set the playback conditions.

The default settings are underlined.

Select "CUSTOM SETUP" in the setup display.

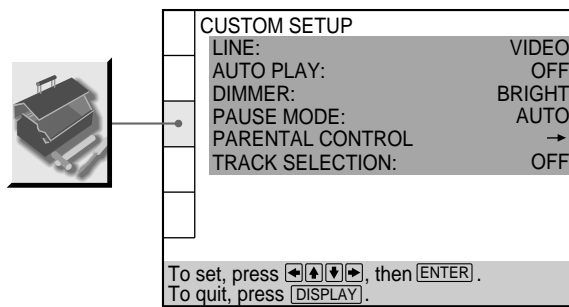

■ LINE

Selects the methods of outputting video signals from the LINE-1(RGB)-TV connector on the rear panel of the player.

- VIDEO: outputs the video signals.
- S VIDEO: outputs the S video signals.
- RGB: outputs the RGB signals.

Notes

- If your TV does not conform to the S video or the RGB signals, no picture appears on the TV screen even if you select "S VIDEO" or "RGB." Refer to the instructions supplied with your TV.
- If your TV has only one SCART (EURO AV) connector, do not select "S VIDEO."

■ AUTO PLAY

Selects the Auto Play setting when you connect the AC power cord to the AC outlet.

- OFF: does not use "TIMER," "DEMO1" or "DEMO2" to start playback.
- TIMER: starts playing at any time you want by connecting a timer (not supplied). Set a timer when the player is in standby mode (the power indicator lights up in red).
- DEMO1: starts playing the first demonstration automatically.
- DEMO2: starts playing the second demonstration automatically.

Custom Settings (CUSTOM SETUP)

■ DIMMER

Adjusts the lighting of the front panel display.

- **BRIGHT**: makes the front panel display bright.
- **DARK**: makes the front panel display dark.
- **OFF**: turns off the lighting of the front panel display.

■ PAUSE MODE (DVD only)

Selects the picture in pause mode.

- **AUTO**: A picture, including subjects that move dynamically, is output with no jitter. Normally select this position.
- **FRAME**: A picture including subjects that do not move dynamically is output with high resolution.

■ PARENTAL CONTROL →

Sets a password and playback limitation level when you play DVDs with playback limitation for children.

The same password is used for both Parental Control and Custom Parental Control (page 38).

For details, see "Limiting Playback by Children (Parental Control) ."

Limiting Playback by Children (Parental Control) **DVD**

Playback of some DVDs can be limited depending on the age of the users. The "Parental Control" function allows you to set a playback limitation level.

Select "CUSTOM SETUP" in the setup display.

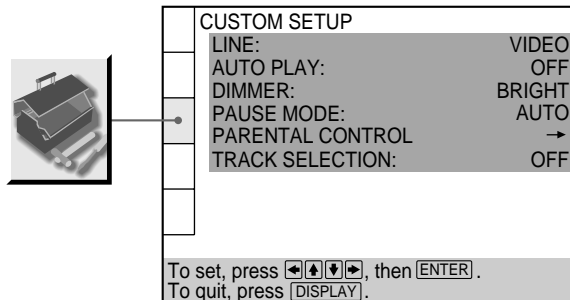

- 1 Select "PARENTAL CONTROL" using ↑/↓, then press ENTER.

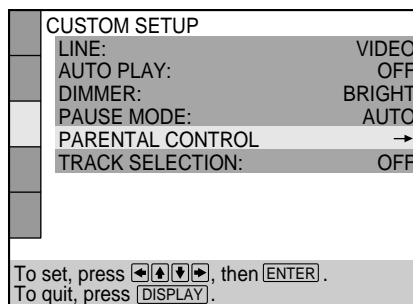

■ When you have not entered a password

The display for entering a password appears.

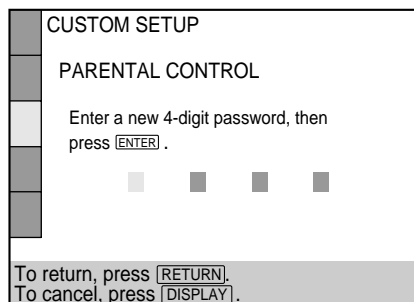

■ When you have already registered a password

The display for confirming the password appears. Skip Step 2.

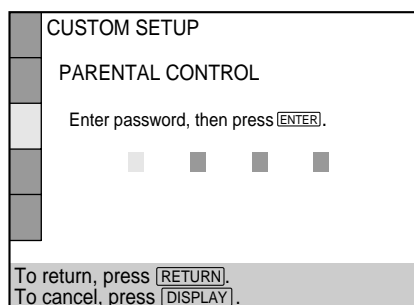

2 Enter a password in 4 digits using the number buttons, then press ENTER.

The digits change to asterisks (*), and the display for confirming the password appears.

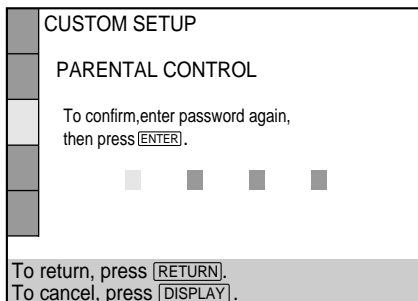

3 To confirm your password, enter it again using the number buttons, then press ENTER.

The display for setting the playback limitation level and changing the password appears.

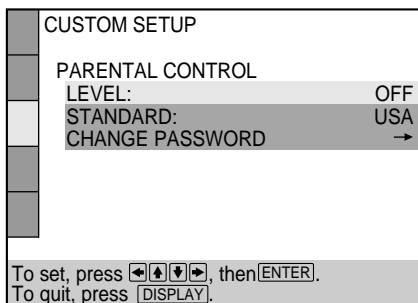

4 Select "STANDARD" using ↑/↓, then press →.

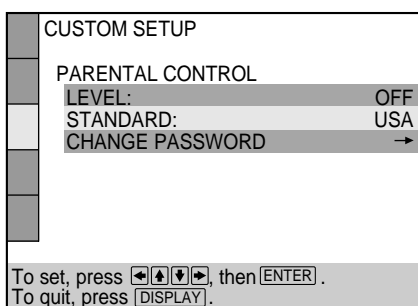

5 Select a geographic area as the playback limitation level standard using ↑/↓, then press →.

When you select "OTHERS→," select and enter the standard code in the table on the next page using the number buttons.

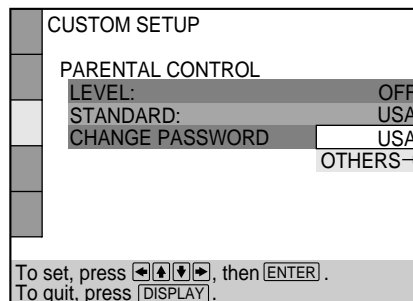

6 Select "LEVEL" using ↑/↓, then press →.

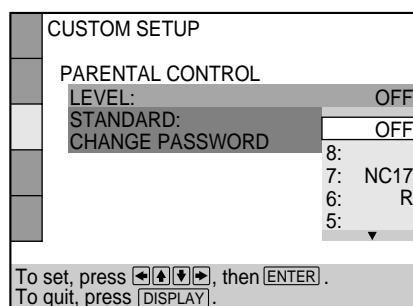

7 Select the level you want using ↑/↓, then press ENTER.

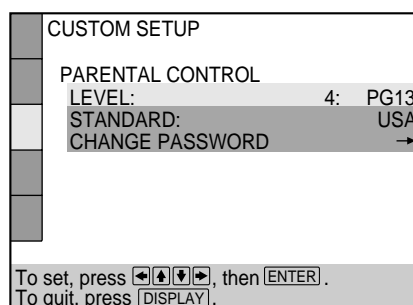

The lower the value, the more strict the limitation.

To return to the normal screen

Press DISPLAY.

To turn off the Parental Control function and play the DVD after entering your password

Set "LEVEL" to "OFF" in Step 7, then press ▷.

Custom Settings (CUSTOM SETUP)

To change the password

1 After Step 3, select "CHANGE PASSWORD" using **↑/↓**, then press **→** or ENTER.

The display for changing the password appears.

2 Follow Steps 2 and 3 to enter a new password.

Playing a disc which is blocked by the playback limitation level

1 Insert the disc and press **▷**.

The PARENTAL CONTROL display appears.

2 Enter a 4-digit password using the number buttons, then press ENTER.

The player starts playback.

When you stop playing the DVD, the level returns to the original level.



If you forget your password

Enter the 6-digit number "199703" in Step 2 to clear the current password. To enter a new password, follow the procedure from Step 2 again.

Notes

- When you play DVDs which do not have the Parental Control function, playback cannot be limited on this player.
- If you do not set a password, you cannot change the settings for playback limitation.
- Depending on the DVD, you may be asked to change the parental control level while playing the disc. In this case, enter the password, then change the level. When you stop playing the DVD, the level returns to the original level.
- The same password is used for both Parental Control and Custom Parental Control (page 38).

| Standard | Code number |
|----------------|-------------|
| Argentina | 2044 |
| Australia | 2047 |
| Austria | 2046 |
| Belgium | 2057 |
| Brazil | 2070 |
| Canada | 2079 |
| Chile | 2090 |
| China | 2092 |
| Denmark | 2115 |
| Finland | 2165 |
| France | 2174 |
| Germany | 2109 |
| Hong Kong | 2219 |
| India | 2248 |
| Indonesia | 2238 |
| Italy | 2254 |
| Japan | 2276 |
| Korea | 2304 |
| Malaysia | 2363 |
| Mexico | 2362 |
| Netherlands | 2376 |
| New Zealand | 2390 |
| Norway | 2379 |
| Pakistan | 2427 |
| Philippines | 2424 |
| Portugal | 2436 |
| Russia | 2489 |
| Singapore | 2501 |
| Spain | 2149 |
| Sweden | 2499 |
| Switzerland | 2086 |
| Taiwan | 2543 |
| Thailand | 2528 |
| United Kingdom | 2184 |

■ TRACK SELECTION

Gives the sound track which contains the highest number of channels priority when you play a DVD on which multiple audio formats (PCM, DTS, MPEG AUDIO or Dolby Digital format) are recorded.

- OFF : No priority given.
- AUTO : Priority given.

Notes

- When you set this item to "AUTO", the language may change depending on the "AUDIO" settings in "LANGUAGE SETUP." The "TRACK SELECTION" setting has higher priority than the "AUDIO" settings in "LANGUAGE SETUP" (page 49).
- If you set "DTS" in "AUDIO SETUP" to "OFF", the DTS sound track is not played even if you set this item to "AUTO" and the highest-numbered channel audio is recorded in DTS format.
- If PCM, DTS, MPEG AUDIO and Dolby Digital sound tracks have the same number of channels, the player selects PCM, DTS, Dolby Digital and MPEG AUDIO sound tracks in this order.
- Depending on the DVD, the audio channel with priority may be predetermined. In this case, you cannot give priority to the DTS, MPEG AUDIO or Dolby Digital format by selecting "AUTO."

Settings for the Sound (AUDIO SETUP)

"AUDIO SETUP" allows you to set the sound according to the playback conditions.

The default settings are underlined.

Select "AUDIO SETUP" in the setup display.

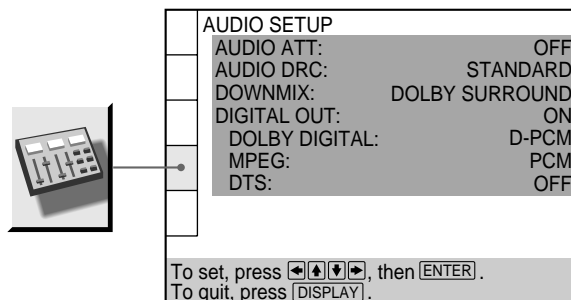

■ AUDIO ATT (attenuation)

If the playback sound is distorted, set this item to "ON."

The player reduces the audio output level.

Selects the setting of the output from the AUDIO OUT and LINE-1, 2 connectors according to the audio equipment to be connected.

- OFF: turns off the audio attenuation. Normally select this position.
- ON: reduces the audio output level so that no sound distortion occurs. Select this when the playback sound from the built-in TV speakers is distorted.

Note

The setting does not affect the output from the DIGITAL OUT OPTICAL and COAXIAL connectors.

■ AUDIO DRC (Dynamic Range Control)

Makes the sound clear when the volume is turned down when playing a DVD. This function works only when you play a DVD which has the AUDIO DRC function. This affects the output from the DIGITAL OUT connectors only when "DOLBY DIGITAL" is set to "D-PCM" and "MPEG" is set to "PCM" in "DIGITAL OUT," and it affects the output from the AUDIO OUT and LINE-1, 2 connectors.

- STANDARD: Normally select this position.
- TV MODE: makes the low sounds clear even if you turn the volume down. It is especially recommended when you listen to the sound using the speakers of the TV.
- WIDE RANGE: It gives you the feeling of being at a live performance. When you use high quality speakers, it is more effective.

Note

When you play DVDs without the AUDIO DRC function, there may be no effect on the sound.

Settings for the Sound (AUDIO SETUP)

■ DOWNMIX

Switches the mixing down methods when you play a DVD on which rear signal components such as LS, RS or S in Dolby Digital format are recorded. For details on the rear signal components, see "Displaying the audio information of the disc" (page 33).

The "DOWNMIX" setting affects the following connectors:

- AUDIO OUT connectors
- DIGITAL OUT OPTICAL and COAXIAL connectors (when you set "DOLBY DIGITAL" to "D-PCM" in "AUDIO SETUP" in the setup display)
- **DOLBY SURROUND**: when the player is connected to an audio component that conforms to Dolby Surround (Pro Logic). The output signals which reproduce the Dolby Surround (Pro Logic) effect are mixed down to 2 channels.
- **NORMAL**: when the player is connected to an audio component that does not conform to Dolby Surround (Pro Logic). The signals without Dolby Surround (Pro Logic) effect are output.

■ DIGITAL OUT

Selects output signals via the DIGITAL OUT OPTICAL and COAXIAL connectors.

- **ON**: Normally select this position. When you select "ON," set "DOLBY DIGITAL," "MPEG" and "DTS." For details on setting these items, see "Setting the Digital Output Signal."
- **OFF**: when the player does not output the sound signals via the DIGITAL OUT OPTICAL and COAXIAL connectors, the influence of the digital circuit upon the analog circuit is at a minimum.

Notes

- When you play sound tracks with a 96 kHz sampling frequency, the output signals from the DIGITAL OUT (OPTICAL, COAXIAL) are converted to 48 kHz (sampling frequency). When the signals are output from the AUDIO OUT connectors, sampling frequency stays at 96kHz and the output signals are converted to analog signals.
- When you select "OFF," you cannot set "DOLBY DIGITAL," "MPEG" and "DTS."

Setting the Digital Output Signal

Switches the methods of outputting audio signals when you, 1. connect a digital component such as a receiver (amplifier) having a digital connector, 2. an audio component having a built-in decoder (Dolby Digital, MPEG or DTS), 3. a DAT or MD via the DIGITAL OUT OPTICAL or COAXIAL connector using an optical or coaxial digital connecting cord. For details on the connection, see pages 12 and 14.

When you select "ON," set "DOLBY DIGITAL," "MPEG" and "DTS."

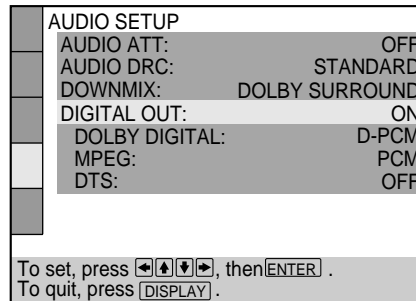

■ DOLBY DIGITAL

Selects the Dolby Digital signals to be output via the DIGITAL OUT OPTICAL and COAXIAL connectors. You cannot select this item when you set "DIGITAL OUT" to "OFF."

- **D-PCM** (Downmix PCM): when you play Dolby Digital sound tracks, the output audio signals are mixed down to 2 channels. You can select whether the signals conform to Dolby Surround (Pro Logic) or not by making adjustments to the "DOWNMIX" item in "AUDIO SETUP."
- **DOLBY DIGITAL**: when the player is connected to an audio component with a built-in Dolby Digital decoder. If the player is connected to an audio component lacking a built-in Dolby Digital decoder, do not set this. Otherwise, when you play the Dolby Digital sound track, a loud noise or no sound will come out from the speakers, affecting your ears or causing the speakers to be damaged.

Note

When you select "D-PCM," set Virtual Enhanced Surround (VES) to "OFF." Otherwise, the player will not output signals from the DIGITAL OUT OPTICAL or COAXIAL connector.

■ MPEG

Selects the MPEG AUDIO signals to be output via the DIGITAL OUT OPTICAL and COAXIAL connectors. You cannot select this item when you set "DIGITAL OUT" to "OFF."

- **PCM**: when the player is connected to an audio component lacking a built-in MPEG decoder. If you play MPEG AUDIO sound tracks, the player outputs stereo signals via the DIGITAL OUT OPTICAL and COAXIAL connectors.
- **MPEG**: when the player is connected to an audio component having a built-in MPEG decoder. If the player is connected to an audio component lacking a built-in MPEG decoder, do not set this. Otherwise, when you play the MPEG AUDIO sound track, a loud noise will come out from the speakers, affecting your ears or causing the speakers to be damaged.

Note

The player outputs the MPEG analog audio sound only from the front speakers when you set "DIGITAL OUT" in "AUDIO SETUP" to "ON" and then set "MPEG" to "MPEG."

■ DTS

Selects the DTS signals to be output via the DIGITAL OUT OPTICAL and COAXIAL connectors. You cannot select this item when you set "DIGITAL OUT" to "OFF."

- **OFF**: when the player is connected to an audio component lacking a built-in DTS decoder.
- **ON**: when the player is connected to an audio component having a built-in DTS decoder. If the player is connected to an audio component lacking a built-in DTS decoder, do not set this. Otherwise, when you play the DTS sound track, a loud noise will come out from the speakers, affecting your ears or causing the speakers to be damaged.

Note

Select the setting correctly. Otherwise, no sound or a strange sound will come out from the speakers, affecting your ears or causing the speakers to be damaged.

Subwoofer Set Up (SPEAKER SETUP)

When you have connected a subwoofer, specify the size of the front speakers you have connected to change the frequency range output from the subwoofer so that you can obtain the best possible surround sound.

Even if you change the "SUBWOOFER" setting, the sound output from the front speakers do not change. For the speaker hookups, see pages 12 and 13. The default settings are underlined.

Select "SPEAKER SETUP" in the setup display.

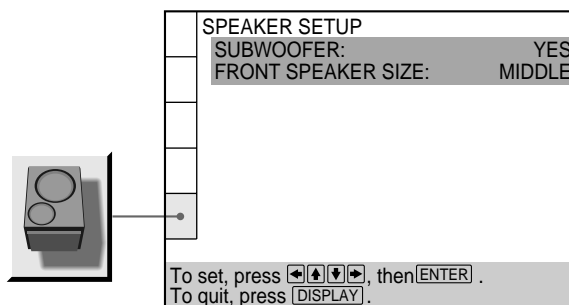

■ SUBWOOFER

Selects whether a subwoofer is connected to the player or not.

- **NONE**: When a subwoofer is not connected to the player.
- **YES**: When a subwoofer is connected to the player. When you select "YES," set "FRONT SPEAKER SIZE." For details, see "Setting the output level from the subwoofer."

Subwoofer Set Up (SPEAKER SETUP)

Setting the output level from the subwoofer

When you select "YES" in "SUBWOOFER," set "FRONT SPEAKER SIZE." This selects the size of the connected front speakers. The frequency range output from the subwoofer varies according to the size of the front speakers.

■ FRONT SPEAKER SIZE

- **LARGE:** If you connect large speakers that will effectively reproduce bass frequencies and play a DVD recorded in 5.1 channels including an LFE signal, select this.

If you feel a lack of bass frequencies from the front speakers when you select this, select "MIDDLE."

Notes

- If an LFE signal is not recorded on the disc, no sound will be output from the subwoofer even if you select "LARGE."
- When you play MPEG AUDIO sound track, an LFE signal is not output from the SUBWOOFER connector.
- **MIDDLE:** If you connect large speakers that will effectively reproduce bass frequencies and play a source on which an LFE signal is not recorded, such as CD or DVD with 2 channels, select this to output the bass frequencies from the subwoofer as well as from the front channel.
If you feel a lack of bass frequencies from the front speakers when you select this, select "SMALL."
- **SMALL:** If you feel a lack of bass, select this to output even more bass frequencies from the subwoofer.
If you still feel a lack of bass frequencies from the front speakers when you select this, select "TV."
- **TV:** If you use the speakers of the TV or small speakers, select this to output the bass frequencies from the subwoofer.

 The subwoofer outputs the LFE signal and the frequency range according to the FRONT SPEAKER SIZE setting.

The LFE signal is output only when the disc contains an LFE signal.

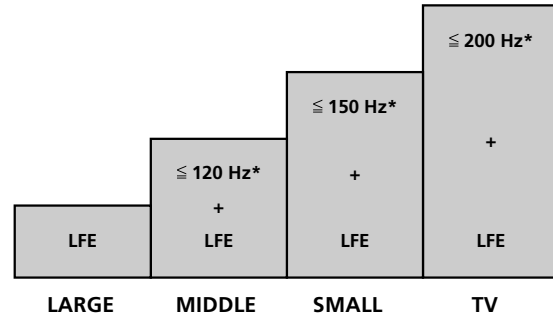

* Audio signal besides LFE

Note

The signals of the PCM sound tracks with a 96 kHz sampling frequency are not output from the WOOFER connector.

Additional Information

Troubleshooting

If you experience any of the following difficulties while using the player, use this troubleshooting guide to help remedy the problem. Should any problem persist, consult your nearest Sony dealer.

Power

The power is not turned on.

- Check that the AC power cord is connected securely.

Picture

There is no picture.

- Check that the player is connected securely.
- The video connecting cord is damaged. Replace it with a new one.
- Make sure you connect the player to the video input connector on the TV. (page 8)
- Make sure you turn on the TV.
- Make sure you select the video input on the TV so that you can view the pictures from the player.

Picture noise appears.

- Clean the disc.
- If the video signal from your DVD player has to go through your VCR to get to your TV, the copy-protection applied to some DVD programs could affect picture quality. If you still experience problems after checking your connections, please try connecting your DVD player directly to your TV's S-input, if your TV is equipped with this input. (page 8)

Even though you set the aspect ratio in "TV TYPE" in "SCREEN SETUP" of the setup display, the picture does not fill the screen.

- The aspect ratio is fixed on your DVD.

The picture is black and white.

- In the setup display, set "LINE" in "CUSTOM SETUP" to the appropriate item that conforms to your TV. (page 51)
- Depending on the TV, the picture on the screen becomes black and white when you play a disc recorded in the NTSC color system.

Sound

There is no sound.

- ➔ Check that the player is connected securely.
- ➔ The audio connecting cord is damaged. Replace it with a new one.
- ➔ Make sure you connect the player to the audio input connectors on the receiver (amplifier). (page 11)
- ➔ Make sure you turn on the TV and the receiver (amplifier).
- ➔ Make sure you select the appropriate input on the receiver (amplifier) so that you can listen to the sound from the player.
- ➔ The player is in pause mode or in Slow-motion Play mode. Press ▷ to return to normal play mode.
- ➔ The player is in fast forward (1▶▶ or 2▶▶) or fast reverse (1◀◀ or 2◀◀) mode. Press ▷ to return to normal play mode.
- ➔ Check the speaker connections and setting (pages 13, 57). Refer to the operating manual of your receiver (amplifier).
- ➔ When you play Dolby Digital/MPEG AUDIO sound tracks and attempt to output from the DIGITAL OUT connectors, set "DIGITAL OUT" to "ON" in the setup display. Otherwise no sound will come from the DIGITAL OUT connectors. (page 56)
- ➔ You selected a VES mode other than "OFF" in the Control Menu display when you connected the component via the DIGITAL OUT OPTICAL or COAXIAL connector. Set "VES" to "OFF" in the Control Menu display. (page 36)
- ➔ When you play DTS sound tracks, no sound will come out from the AUDIO OUT connectors. (page 19)

Sound is noisy.

- ➔ Clean the disc.
- ➔ When you play a CD with DTS sound tracks, sound noise will come out from the AUDIO OUT connectors. (page 19)

Sound distortion occurs.

- ➔ In the setup display, set "AUDIO ATT" in "AUDIO SETUP" to "ON."

The sound loses its stereo effect when you play a VIDEO CD or a CD.

- ➔ Set "AUDIO" to "STEREO" in the Control Menu display. (page 32)
- ➔ Make sure you connect the player correctly. (page 8, 11, 13, 14)

The surround effect is difficult to hear when you are playing a Dolby Digital sound track.

- ➔ Check the speaker connections and setting (pages 13, 57). Refer to the operating manual of your receiver (amplifier).
- ➔ Depending on the DVD, the output signal may not be the entire 5.1 channels. It may be monaural or stereo even if the sound track is recorded in Dolby Digital format.

Operation

The remote does not function.

- ➔ Remove any obstacles between the remote and the player.
- ➔ Use the remote near the player.
- ➔ Point the remote at the remote sensor  on the player.
- ➔ Replace all of the batteries in the remote with new ones if they are weak.

The disc does not play.

- ➔ There is no disc inside ("Insert disc." appears on the TV screen).
Insert a disc.
- ➔ Insert the disc correctly with the playback side facing down on the disc tray.
- ➔ Clean the disc.
- ➔ The player cannot play CD-ROMs, etc. (page 5)
Insert a DVD, a VIDEO CD, or CD.
- ➔ Check the region code of the DVD. (page 4)
- ➔ Moisture has condensed inside the player. Remove the disc and leave the player turned on for about half an hour. (page 6)

The player does not play from the beginning when playing a disc.

- ➔ Program Play, Shuffle Play, Repeat Play or A-B Repeat Play has been selected. Press CLEAR. (pages 40 through 45)
- ➔ Resume Play has been selected.
Press ■ on the front panel or on the remote before you start playing. (page 21)
- ➔ A title menu or a DVD menu automatically appears on the TV screen when you play your DVD, or a setup display automatically appears on the TV screen when you play your VIDEO CD with PBC functions.

The player starts playing the DVD automatically.

- ➔ The DVD features the auto playback function.

Playback stops automatically.

- ➔ The disc may contain an auto pause signal. While playing such a disc, the player stops playback at the signal.

You cannot perform some functions such as Stop, Search, Slow-motion Play, Repeat Play, Shuffle Play or Program Play.

- ➔ Depending on the disc, you may not be able to do some of the operations above.

Messages do not appear on the TV screen in the language you want.

- ➔ In the setup display, select the desired language for the on-screen display in "OSD" under "LANGUAGE SETUP." (page 49)

The language for the sound track cannot be changed when you play a DVD.

- ➔ Multilingual tracks are not recorded on the DVD.
- ➔ Changing the language for the track is prohibited on the DVD.

The subtitle language cannot be changed when you play a DVD.

- ➔ Multilingual subtitles are not recorded on the DVD.
- ➔ Changing the language for the subtitles is prohibited on the DVD.

The subtitles cannot be turned off when you play a DVD.

- ➔ Depending on the DVD, you may not be able to turn the subtitles off.

The angles cannot be changed when you play a DVD.

- ➔ Multi-angles are not recorded on the DVD.
- ➔ Change the angles when "ANGLE" appears on the front panel display. (page 35)
- ➔ Changing the angles is prohibited on the DVD.

The player does not operate properly.

- ➔ Static electricity, etc., may affect the player's operation.
Disconnect the AC power cord once, then connect it again.

Nothing is displayed on the front panel display.

- ➔ In the set up display, "DIMMER" in "CUSTOM SETUP" is set to "OFF."
Set "DIMMER" to "BRIGHT" or "DARK." (page 51)

5 numbers or letters are displayed on the screen and on the front panel display.

- ➔ The self-diagnosis function was activated. See the table on page 62.

The disc tray does not open and "LOCKED" is displayed on the front panel display.

- ➔ Contact your Sony dealer or local authorized Sony service facility.

Self-diagnosis function

When the self-diagnosis function activates to prevent the player from malfunctioning, a five-character service number (combination of a letter and digits) flashes on the screen and on the front panel display. In this case, check the following table.

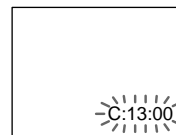

| First three characters | Cause and/or Corrective Action |
|------------------------|--|
| C13 | <ul style="list-style-type: none">• The disc is dirty. ➔ Clean the disc with a cleaning cloth. (page 6) |
| C31 | <ul style="list-style-type: none">• The disc is not inserted correctly. ➔ Open the disc tray and insert the disc correctly. |
| Exx (xx is any number) | <ul style="list-style-type: none">• To prevent a malfunction, the player has performed the self-diagnosis function. ➔ When you contact your Sony dealer or local authorized Sony service facility, give the 5-character service number. (example: E:61:10) |

Specifications

CD/DVD player

Laser Semiconductor laser
Signal format system PAL/(NTSC)

Audio characteristics

Frequency response
 DVD (PCM 96 kHz): 2 Hz to 44 kHz (± 1 dB)*
 DVD (PCM 48 kHz): 2 Hz to 22 kHz (± 0.5 dB)
 CD: 2 Hz to 20 kHz (± 0.5 dB)

Signal-to-noise ratio
 More than 110 dB (AUDIO OUT connectors only)

Harmonic distortion
 Less than 0.003 %

Dynamic range
 More than 100 dB (DVD)
 More than 97 dB (CD)

Wow and flutter
 Less than detected value ($\pm 0.001\%$ W PEAK)

Outputs

| | Jack type | Output level | Load impedance |
|-----------------------|--------------------------|---|--|
| AUDIO OUT (R, L) | Phono jacks | 2 Vrms (at 50 kilohms) | Over 10 kilohms |
| DIGITAL OUT (OPTICAL) | Optical output connector | -18 dBm | Wave length: 660 nm |
| DIGITAL OUT (COAXIAL) | Phono jack | 0.5 Vp-p | 75 ohms terminated |
| VIDEO OUT | Phono jack | 1.0 Vp-p | 75 ohms, sync negative |
| S VIDEO OUT | 4-pin mini DIN | Y: 1.0 Vp-p C: 0.3 Vp-p (PAL) 0.286 Vp-p (NTSC) | 75 ohms, sync negative 75 ohms terminated |
| AUDIO OUT (WOOFER) | Phono jack | 2 Vrms (at 50 kilohms) | Over 10 kilohms |

General

Power requirements
 220-240 V AC, 50/60 Hz

Power consumption
 15 W

Dimensions (approx.)
 430 × 69 × 252 mm (17 × 2 3/4 × 10 in.)
 (w/h/d) incl. projecting parts

Mass (approx.)
 2.8 kg (6 lb 3 oz)

Operating temperature
 5 °C to 35 °C

Operating humidity
 25 % to 80 %

Supplied accessories

See page 7.

* The signals from AUDIO OUT connectors are measured. When you play PCM sound tracks with a 96 kHz sampling frequency, the output signals from the DIGITAL OUT (OPTICAL, COAXIAL) are converted to 48 kHz (sampling frequency).

Design and specifications are subject to change without notice.

Glossary

Bit rate (page 38)

Value indicating the amount of video data compressed in a DVD per second. The unit is Mbps (Mega bit per second). 1 Mbps indicates that the data per second is 1,000,000 bits. The higher the bit rate, the larger the amount of data. However, this does not always mean that you can get higher quality pictures.

Chapter (page 5)

Sections of a picture or a music piece on a DVD that are smaller than titles. A title is composed of several chapters. Each chapter is assigned a chapter number enabling you to locate the chapter you want.

Digital Cinema Sound (DCS) (page 36)

The general name of technology that Sony developed to enjoy surround sound in a home. It simulates the sound not of a concert hall as usual but of a movie editing studio so that you can enjoy the surround sound of a movie theater in the comfort of your own home. The VES (Virtual Enhanced Surround) system contained in DCS programs can create the sound image of virtual rear speakers from the sound of the front speakers (L, R) without using actual rear speakers.

Dolby Digital (pages 11, 56)

Digital audio compression technology that Dolby Laboratories Corporation developed. This technology conforms to 5.1-channel surround sound. The rear channel is stereo and there is a discrete subwoofer channel in this format. Dolby Digital provides the same 5.1 discrete channels of high quality digital audio found in Dolby Digital cinema audio systems. Good channel separation is realized because all of the channel data is recorded discretely and processed in digital.

Dolby Pro Logic (page 56)

Audio signal processing technology that Dolby Laboratories Corporation developed for surround sound. When the input signal contains a surround component, the Pro Logic process outputs the front, center and rear signals. The rear channel is monaural.

DTS (pages 14, 57)

Digital audio compression technology that Digital Theater Systems, Inc. developed. This technology conforms to 5.1-channel surround. The rear channel is stereo and there is a discrete subwoofer channel in this format. DTS provides the same 5.1 discrete channels of high quality digital audio. Good channel separation is realized because all of the channel data is recorded discretely and processed in digital.

DVD (page 4)

A disc that contains up to 8 hours of moving pictures even though its diameter is the same as a CD.

The data capacity of a single-layer and single-sided DVD is 4.7 GB (Giga Byte) which is 7 times that of a CD. The data capacity of a dual-layer and single-sided DVD is 8.5 GB, a single-layer and double-sided DVD is 9.4 GB, and a dual-layer and double-sided DVD is 17 GB.

The picture data uses the MPEG 2 format, one of the worldwide standards of digital compression technology. The picture data is compressed to about 1/40 of its original size. The DVD also uses a variable rate coding technology that changes the data to be allocated according to the status of the picture.

Audio data is recorded in Dolby Digital as well as in PCM, allowing you to enjoy a more real audio presence. Furthermore, various advanced functions such as the multi-angle, multilingual, and Parental Control functions are provided with the DVD.

MPEG AUDIO (page 14)

International standard coding system used to compress audio digital signals authorized by ISO/IEC. MPEG 1 conforms to up to 2-channel stereo. MPEG 2 used on DVDs conforms to up to 7.1-channel surround.

Multi-angle function (page 35)

Various angles for the scene (viewpoints of the video camera) are recorded on some DVDs.

Multilingual function (pages 16, 34, 49)

Several languages for the audio track or sub-titles in a picture are recorded on some DVDs.

Parental Control (page 52)

A function of the DVD used to limit playback of the disc according to the age of the user and the limitation level in each country. The limitation varies from disc to disc; when it is activated, playback is completely prohibited, violent scenes are skipped or replaced with other scenes, and so on.

Playback Control (PBC) (page 23)

Signals encoded on VIDEO CDs (Version 2.0) to control playback.

By using menus recorded on VIDEO CDs with PBC functions, you can enjoy playing simple interactive programs, programs with search functions, and so on.

Title (page 5)

The longest sections of a picture or a music piece on a DVD; a movie, etc., for a picture piece on video software; or an album, etc., for a music piece on audio software. Each title is assigned a title number enabling you to locate the title you want.

Track (page 5)

Sections of a picture or a music piece on a CD or VIDEO CD. Each track is assigned a track number enabling you to locate the track you want.

VIDEO CD (page 4)

A compact disc that contains moving pictures.

The picture data uses the MPEG 1 format, one of the worldwide standards of digital compression technology.

The picture data is compressed to about 1/140 of its original size. Consequently, a 12 cm VIDEO CD can contain up to 74 minutes of moving pictures.

VIDEO CDs also contain compact audio data. Sounds outside the range of human hearing are compressed while the sounds we can hear are not compressed. VIDEO CDs can hold 6 times the audio information of conventional audio CDs.

There are 2 versions of VIDEO CDs.

- Version 1.1: You can play only moving pictures and sounds.
- Version 2.0: You can play high-resolution still pictures and enjoy PBC functions.

This player conforms to both versions.

Language Code List

For details, see page 34, 49.

The language spellings conform to the ISO 639: 1988 (E/F) standard.

| Code | Language | Code | Language | Code | Language | Code | Language |
|------|-----------------|------|------------------|------|----------------|------|---------------|
| 1027 | Afar | 1186 | Scots Gaelic | 1350 | Malayalam | 1513 | Siswati |
| 1028 | Abkhazian | 1194 | Galician | 1352 | Mongolian | 1514 | Sesotho |
| 1032 | Afrikaans | 1196 | Guarani | 1353 | Moldavian | 1515 | Sundanese |
| 1039 | Amharic | 1203 | Gujarati | 1356 | Marathi | 1516 | Swedish |
| 1044 | Arabic | 1209 | Hausa | 1357 | Malay | 1517 | Swahili |
| 1045 | Assamese | 1217 | Hindi | 1358 | Maltese | 1521 | Tamil |
| 1051 | Aymara | 1226 | Croatian | 1363 | Burmese | 1525 | Telugu |
| 1052 | Azerbaijani | 1229 | Hungarian | 1365 | Nauru | 1527 | Tajik |
| 1053 | Bashkir | 1233 | Armenian | 1369 | Nepali | 1528 | Thai |
| 1057 | Byelorussian | 1235 | Interlingua | 1376 | Dutch | 1529 | Tigrinya |
| 1059 | Bulgarian | 1239 | Interlingue | 1379 | Norwegian | 1531 | Turkmen |
| 1060 | Bihari | 1245 | Inupiak | 1393 | Occitan | 1532 | Tagalog |
| 1061 | Bislama | 1248 | Indonesian | 1403 | (Afan) Oromo | 1534 | Setswana |
| 1066 | Bengali; Bangla | 1253 | Icelandic | 1408 | Oriya | 1535 | Tonga |
| 1067 | Tibetan | 1254 | Italian | 1417 | Punjabi | 1538 | Turkish |
| 1070 | Breton | 1257 | Hebrew | 1428 | Polish | 1539 | Tsonga |
| 1079 | Catalan | 1261 | Japanese | 1435 | Pashto; Pushto | 1540 | Tatar |
| 1093 | Corsican | 1269 | Yiddish | 1436 | Portuguese | 1543 | Twi |
| 1097 | Czech | 1283 | Javanese | 1463 | Quechua | 1557 | Ukrainian |
| 1103 | Welsh | 1287 | Georgian | 1481 | Rhaeto-Romance | 1564 | Urdu |
| 1105 | Danish | 1297 | Kazakh | 1482 | Kirundi | 1572 | Uzbek |
| 1109 | German | 1298 | Greenlandic | 1483 | Romanian | 1581 | Vietnamese |
| 1130 | Bhutani | 1299 | Cambodian | 1489 | Russian | 1587 | Volapük |
| 1142 | Greek | 1300 | Kannada | 1491 | Kinyarwanda | 1613 | Wolof |
| 1144 | English | 1301 | Korean | 1495 | Sanskrit | 1632 | Xhosa |
| 1145 | Esperanto | 1305 | Kashmiri | 1498 | Sindhi | 1665 | Yoruba |
| 1149 | Spanish | 1307 | Kurdish | 1501 | Sangho | 1684 | Chinese |
| 1150 | Estonian | 1311 | Kirghiz | 1502 | Serbo-Croatian | 1697 | Zulu |
| 1151 | Basque | 1313 | Latin | 1503 | Singhalese | 1703 | Not specified |
| 1157 | Persian | 1326 | Lingala | 1505 | Slovak | | |
| 1165 | Finnish | 1327 | Laothian | 1506 | Slovenian | | |
| 1166 | Fiji | 1332 | Lithuanian | 1507 | Samoan | | |
| 1171 | Faroese | 1334 | Latvian; Lettish | 1508 | Shona | | |
| 1174 | French | 1345 | Malagasy | 1509 | Somali | | |
| 1181 | Frisian | 1347 | Maori | 1511 | Albanian | | |
| 1183 | Irish | 1349 | Macedonian | 1512 | Serbian | | |

Index to Parts and Controls

Refer to the pages indicated in parentheses for details.

Front Panel

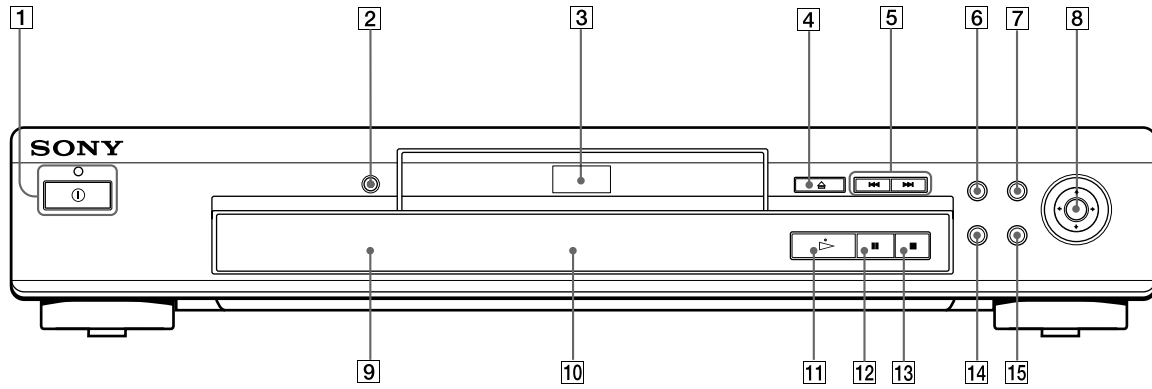

- 1** **⏻ (power) button and indicator (18)**
Disconnects the power of the player or places the player in standby mode.
- 2** **VES (Virtual Enhanced Surround) button (36)**
Press to select the desired "VES" item.
- 3** **Disc tray (18)**
Place a disc on the tray.
- 4** **⏪/⏩ OPEN/CLOSE button (18)**
Opens or closes the disc tray.
- 5** **⏮/⏭ IPREV/NEXT (previous/next) buttons (19)**
Press to go to the next chapter or track, or to go back to the previous chapter or track.
- 6** **TITLE button (22)**
Displays the title menu on the TV screen.
- 7** **DVD MENU button (22)**
Displays the DVD menu on the TV screen.
- 8** **⏪/⏩/⏮/⏭/ENTER button**
Selects and executes the items or settings.
- 9** **📡 (remote sensor) (7)**
Accepts the remote control signals.
- 10** **Front Panel Display (24)**
Indicates the playing time, etc.
- 11** **▶ (play) button (18)**
Plays a disc.
- 12** **⏸ (pause) button (19)**
Pauses playing a disc.
- 13** **■ (stop) button (19, 21)**
Stops playing a disc.
- 14** **DISPLAY button (26)**
Displays the Control Menu display on the TV screen to set or adjust the items.
- 15** **↶ RETURN button (23, 27)**
Press to return to the previously selected screen, etc.

Rear Panel

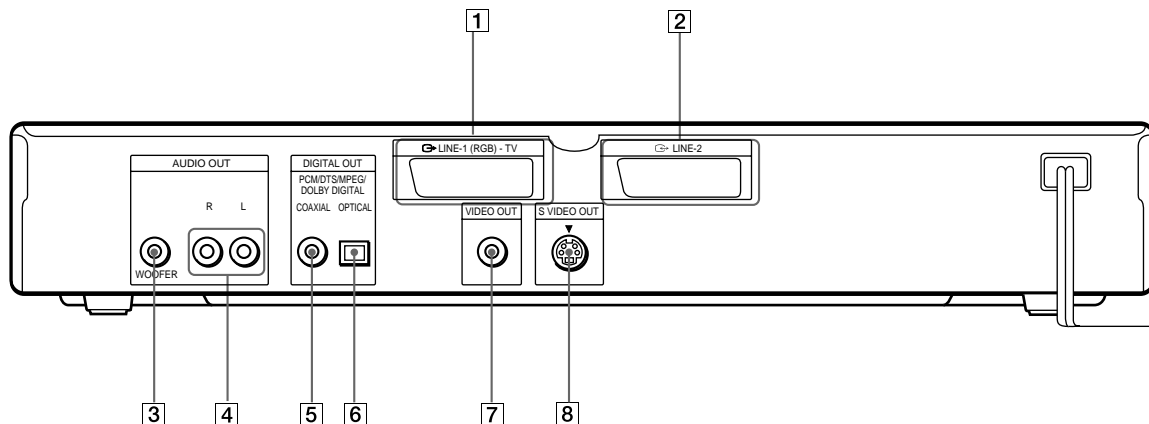

Additional Information

- 1 LINE-1 (RGB)-TV connector (8, 51)**
Connect to your TV using a LINE-1 connector to output the signal from the player. You can select the video signals, the S VIDEO signals or the RGB signals as the output signal format.
- 2 LINE-2 connector (8)**
Connect your video equipment using a LINE-2 connector to input the signal from the equipment.
- 3 AUDIO OUT WOOFER connector (13)**
Connect to a subwoofer (not supplied).
- 4 AUDIO OUT R (right)/L (left) connectors (9, 11)**
Connect to the audio input connector on your TV or receiver (amplifier).
- 5 DIGITAL OUT COAXIAL connector (12, 14)**
Connect to an audio component using the coaxial digital connecting cord.
- 6 DIGITAL OUT OPTICAL connector (12, 14)**
Connect to an audio component using the optical digital connecting cord.
- 7 VIDEO OUT connector (9, 11)**
Connect to the video input connector on your TV or monitor.
- 8 S VIDEO OUT connector (9, 11)**
Connect to the S video input connector on your TV or monitor.

Remote

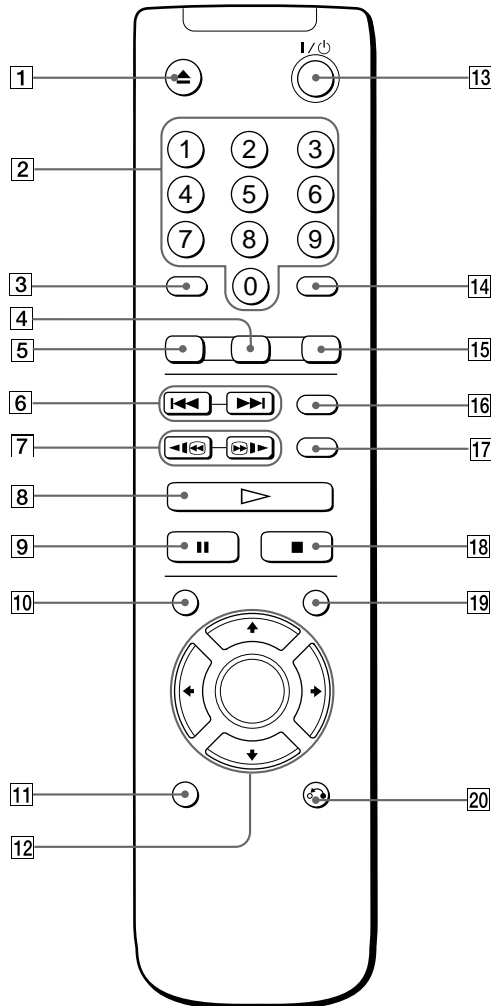

- 1 ▲OPEN/CLOSE button (18)**
Opens or closes the disc tray.
- 2 Number buttons**
Selects the items or settings.
- 3 CLEAR button (29, 41)**
Press to return to continuous play, etc.
- 4 ANGLE button (35)**
Changes the angles when playing a DVD.
- 5 AUDIO button (32)**
Changes the sound while playing a DVD or VIDEO CD.
- 6 ◀◀/▶▶PREV/NEXT (previous/next) buttons (19)**
Press to go to the next chapter or track, or to go back to the previous chapter or track.
- 7 ◀◀(S)/▶▶ SCAN/SLOW buttons (20)**
Locate a point quickly while monitoring the picture or play a disc in slow motion.

- 8 ▷PLAY button (18)**
Plays a disc.
- 9 ■PAUSE button (19)**
Pauses playing a disc.
- 10 TITLE button (22)**
Displays the title menu on the TV screen.
- 11 DISPLAY button (26)**
Displays the Control Menu display on the TV screen to set or adjust the items.
- 12 ◀/↑/↓/▶/ENTER buttons**
Selects and executes the items or settings.
- 13 I/⏻ (on/standby) button (19)**
Press to turn on the player or place it in standby mode after power is connected by pressing ① on the player.
- 14 ENTER button**
Executes the items or settings.
- 15 SUBTITLE button (34)**
Changes the subtitles when playing a DVD.
- 16 TV/DVD button (10)**
Press to return the TV's input from CD/DVD player to the TV when you connect the player to your TV via the SCART (EURO AV) connectors.
- 17 TIME/TEXT button (24)**
Displays the playing time of the disc, etc., on the front panel display.
- 18 ■STOP button (19, 21)**
Stops playing a disc.
- 19 DVD MENU button (22)**
Displays the DVD menu on the TV screen.
- 20 ↶RETURN button (23, 27)**
Press to return to the previously selected screen, etc.

Index

Numerics

- 2.1 Channel Surround 13
- 4:3 LETTER BOX 50
- 4:3 PAN SCAN 50
- 5.1 Channel Surround 14
- 16:9 50

A

- A-B Repeat 44
- A-B REPEAT 44
- ADVANCED 37
- Angle 35
- ANGLE 35
- AUDIO 32, 49
- AUDIO ATT 55
- AUDIO DRC 55
- AUDIO SETUP 55
- AUTO PLAY 51

B

- BACKGROUND 51
- Batteries 7

C

- CD 4, 18
- Chapter 5, 29, 64
- CHAPTER 29
- Connecting 8, 11, 13, 14
- Continuous play
 - CD/VIDEO CD 18
 - DVD 18
- Control Menu display 26
- CUSTOM PARENTAL CONTROL 38
- CUSTOM SETUP 51

D, E

- DIGITAL OUT 56
- Digital output 12, 14, 56
- DIMMER 52
- Display
 - Control Menu display 26
 - Front panel display 24
 - Setup display 46
- Dolby Digital 11, 56
- DTS 57
- DVD 4, 18
- DVD menu 49

F, G

- Fast Forward 20
- Fast Reverse 20
- Front panel display 24

H

- Handling discs 6
- Hooking up 8, 11, 13, 14

I, J, K

- Index 5, 29
- INDEX 29

L

- LANGUAGE SETUP 49
- LETTER BOX 50
- Locating
 - a specific point 20
 - by watching the TV screen 20

M, N, O

- MPEG 57
- On-screen display
 - Control Menu display 26
 - Setup display 46
- OSD 49

P, Q

- PAN SCAN 50
- PARENTAL CONTROL 52
- PBC functions 23
- PBC Playback 23, 64
- PRO LOGIC 56
- PROGRAM 40
- Program Play 40

R

- Remote 7
- REPEAT 43
- Resume Play 21

S

- S video output 8, 11
- Scene 5
- SCENE 29
- SCREEN SAVER 51
- SCREEN SETUP 50
- Searching. See Locating.
- Setup display 46
- SHUFFLE 42
- Shuffle Play 42
- Slow-motion Play 20
- SPEAKER SETUP 57
- Speakers
 - hookup 13, 14
 - set up 57
- SUBTITLE 34

T

- TIME/TEXT 30, 31
- Title 5, 29, 65
- TITLE 29
- Title menu 22
- Track 5, 29, 65
- TRACK 29
- TRACK SELECTION 55
- Troubleshooting 59
- TV TYPE 50

U

- Usable discs 4

V, W, X, Y, Z

- VES 36
- VIDEO CD 4, 18

