

CD/DVD Player

Operating Instructions

For customers in the U.S.A Owner's Record

The model and serial numbers are located at the rear of the unit. Record the serial number in the space provided below. Refer to them whenever you call upon your Sony dealer regarding this product.

Model No. DVP-NS575P

Serial No. _____

For Customers in Canada

If this product is not working properly, please call 1-877-602-2008 for **Peace of Mind Warranty Replacement service.**

For other product related questions please contact our **Customer Information Service Centre** at 1-877-899-7669 or write to us at: Customer Information Service 115 Gordon Baker Road, Toronto, Ontario, M2H 3R6



DVP-NS575P

WARNING

To prevent fire or shock hazard, do not expose the unit to rain or moisture. To avoid electrical shock, do not open the cabinet. Refer servicing to qualified personnel only.

The AC power cord must be changed only at a qualified service shop.

CAUTION

The use of optical instruments with this product will increase eye hazard. As the laser beam used in this CD/DVD player is harmful to eyes, do not attempt to disassemble the cabinet.

Refer servicing to qualified personnel only.

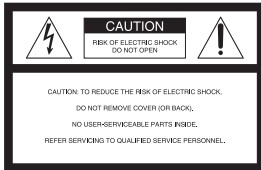

This symbol is intended to alert the user to the presence of uninsulated “dangerous voltage”

within the product’s enclosure that may be of sufficient magnitude to constitute a risk of electric shock to persons.



This symbol is intended to alert the user to the presence of important operating and

maintenance (servicing) instructions in the literature accompanying the appliance.

CAUTION

TO PREVENT ELECTRIC SHOCK, MATCH WIDE BLADE OF PLUG TO WIDE SLOT, FULLY INSERT.

CAUTION

You are cautioned that any change or modifications not expressly approved in this manual could void your authority to operate this equipment.

Note

This equipment has been tested and found to comply with the limits for a Class B digital device, pursuant to Part 15 of the FCC Rules. These limits are designed to provide reasonable protection against harmful interference in a residential installation. This equipment generates, uses, and can radiate radio frequency energy and, if not installed and used in accordance with the instructions, may cause harmful interference to radio communications. However, there is no guarantee that interference will not occur in a particular installation. If this equipment does cause harmful interference to radio or television reception, which can be determined by turning the equipment off and on, the user is encouraged to try to correct the interference by one or more of the following measures:

- Reorient or relocate the receiving antenna.
- Increase the separation between the equipment and receiver.
- Connect the equipment into an outlet on a circuit different from that to which the receiver is connected.
- Consult the dealer or an experienced radio/TV technician for help.

Welcome!

Thank you for purchasing this Sony CD/DVD Player. Before operating this player, please read this manual thoroughly and retain it for future reference.

S

Federal Circuit

t

national

s

disclosure

t

national

t

will

in or a of any k

202

- Never place the set in a confined space, such as a bookcase, or built-in cabinet, unless proper ventilation is provided.
- Do not place the set near or over a radiator or heat register, or where it is exposed to direct sunlight.

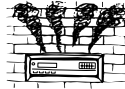

Antennas

Outdoor antenna grounding

If an outdoor antenna or cable system is installed, follow the precautions below.

An outdoor antenna system should not be located in the vicinity of overhead power lines or other electric light or power circuits, or where it can come in contact with such power lines or circuits.

WHEN INSTALLING AN OUTDOOR ANTENNA SYSTEM, EXTREME CARE SHOULD BE TAKEN TO KEEP FROM CONTACTING SUCH POWER LINES OR CIRCUITS AS CONTACT WITH THEM IS ALMOST INVARIABLY FATAL.

Be sure the antenna system is grounded so as to provide some protection against voltage surges and built-up static charges. Section 810 of the National Electrical Code provides information with respect to proper grounding of the mast and supporting structure, grounding of the lead-in wire to an antenna discharge unit, size of grounding conductors, location of antenna-discharge unit, connection to grounding electrodes, and requirements for the grounding electrode.

Antenna Grounding According to the National Electrical Code

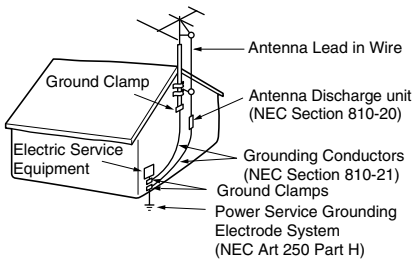

NEC-NATIONAL ELECTRICAL CODE

Lightning

For added protection for this set during a lightning storm, or when it is left unattended and unused for long periods of time, unplug it from the wall outlet and disconnect the antenna or cable system. This will prevent damage to the set due to lightning and power-line surges.

Service

Damage Requiring Service

Unplug the set from the wall outlet and refer servicing to qualified service personnel under the following conditions:

- When the power cord or plug is damaged or frayed.

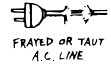

- If liquid has been spilled or objects have fallen into the set.



- If the set has been exposed to rain or water.

- If the set has been subject to excessive shock by being dropped, or the cabinet has been damaged.

- If the set does not operate normally when following the operating instructions. Adjust only those controls that are specified in the operating instructions. Improper adjustment of other controls may result in damage and will often require extensive work by a qualified technician to restore the set to normal operation.
- When the set exhibits a distinct change in performance - this indicates a need for service.

Servicing

Do not attempt to service the set yourself as opening or removing covers may expose you to dangerous voltage or other hazards.

Refer all servicing to qualified service personnel.

Replacement parts

When replacement parts are required, be sure the service technician has used replacement parts specified by the manufacturer that have the same characteristics as the original parts.

Unauthorized substitutions may result in fire, electric shock, or other hazards.

Safety Check

Upon completion of any service or repairs to the set, ask the service technician to perform routine safety checks (as specified by the manufacturer) to determine that the set is in safe operating condition.

Precautions

- The power requirements and power consumption of this player are indicated on the back of the player. Check that the player's operating voltage is identical with your local power supply.

Power requirements and power consumption →



On safety

- To prevent fire or shock hazard, do not place objects filled with liquids, such as vases, on the apparatus.
- Should any solid object or liquid fall into the cabinet, unplug the player and have it checked by qualified personnel before operating it any further.

On power sources

- The player is not disconnected from the AC power source as long as it is connected to the wall outlet, even if the player itself has been turned off.
- If you are not going to use the player for a long time, be sure to disconnect the player from the wall outlet. To disconnect the AC power cord, grasp the plug itself; never pull the cord.
- Should the AC power cord need to be changed, have it done at a qualified service shop only.

On placement

- Place the player in a location with adequate ventilation to prevent heat build-up in the player.
- Do not place the player on a soft surface such as a rug that might block the ventilation holes.
- Do not place the player in a location near heat sources, or in a place subject to direct sunlight, excessive dust, or mechanical shock.
- Do not install the player in an inclined position. It is designed to be operated in a horizontal position only.
- Keep the player away from equipment with strong magnets, such as microwave ovens, or large loudspeakers.
- Do not place heavy objects on the player.

For the model supplied with the AC plug adaptor

If the AC plug of your unit does not fit into the wall outlet, attach the supplied AC plug adaptor.

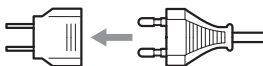

On operation

- If the player is brought directly from a cold to a warm location, or is placed in a very damp room, moisture may condense on the lenses inside the player. Should this occur, the player may not operate properly. In this case, remove the disc and leave the player turned on for about half an hour until the moisture evaporates.
- When you move the player, take out any discs. If you don't, the disc may be damaged.

On adjusting volume

Do not turn up the volume while listening to a section with very low level inputs or no audio signals. If you do, the speakers may be damaged when a peak level section is played.

On cleaning

Clean the cabinet, panel, and controls with a soft cloth slightly moistened with a mild detergent solution. Do not use any type of abrasive pad, scouring powder or solvent such as alcohol or benzine.

On cleaning discs

Do not use a commercially available cleaning disc. It may cause a malfunction.

IMPORTANT NOTICE

Caution: This player is capable of holding a still video image or on-screen display image on your television screen indefinitely. If you leave the still video image or on-screen display image displayed on your TV for an extended period of time you risk permanent damage to your television screen. Plasma display panel televisions and projection televisions are susceptible to this.

If you have any questions or problems concerning your player, please consult your nearest Sony dealer.

Table of Contents

WARNING	2
Welcome!	2
Important Safeguards	3
Precautions	5
About this Manual	8
This Player Can Play the Following Discs	8
Notes about the Discs	9
Index to Parts and Controls	10
Guide to the Control Menu Display	14
Hookups	17
Hooking Up the Player	17
Step 1: Unpacking	17
Step 2: Inserting Batteries into the Remote	17
Step 3: Connecting the Video Cords	18
Step 4: Connecting the Audio Cords	20
Step 5: Connecting the Power Cord	25
Step 6: Quick Setup	25
Playing Discs	27
Playing Discs	27
Resuming Playback from the Point Where You Stopped the Disc (Multi-disc Resume)	29
Using the DVD's Menu	30
Selecting "ORIGINAL" or "PLAY LIST" on a DVD-RW Disc	30
Playing VIDEO CDs with PBC Functions (PBC Playback)	31
Various Play Mode Functions (Program Play, Shuffle Play, Repeat Play, A-B Repeat Play)	32
Searching for a Scene	37
Searching for a Particular Point on a Disc (Search, Scan, Slow-motion Play, Freeze Frame)	37
Searching for a Title/Chapter/Track/Scene, etc.	38
Searching by Scene (PICTURE NAVIGATION)	40
Viewing Information About the Disc	41
Checking the Playing Time and Remaining Time	41
Sound Adjustments	44
Changing the Sound	44
TV Virtual Surround Settings (TVS)	45
Enjoying Movies	47
Changing the Angles	47
Displaying the Subtitles	47
Adjusting the Playback Picture (CUSTOM PICTURE MODE)	48
Sharpening the Outline of an Image (SHARPNESS)	49

Playing a DATA CD	50
About MP3 Audio Tracks and JPEG Image Files	50
Playing DATA CDs with MP3 Audio Tracks and JPEG Image Files	51
Specifying the slideshow duration	56
Selecting an effect for image files in the slideshow	57





Using Various Additional Functions	58
Locking Discs (CUSTOM PARENTAL CONTROL, PARENTAL CONTROL)	58
Controlling Your TV with the Supplied Remote	62

Settings and Adjustments	63
Using the Setup Display	63
Setting the Display or Sound Track Language (LANGUAGE SETUP)	64
Settings for the Display (SCREEN SETUP)	65
Custom Settings (CUSTOM SETUP)	67
Settings for the Sound (AUDIO SETUP)	68

Additional Information	70
Troubleshooting	70
Self-diagnosis Function (When letters/numbers appear in the display)	73
Glossary	73
Specifications	76
Language Code List	77
Index	78





About this Manual

- Instructions in this manual describe the controls on the remote. You can also use the controls on the player if they have the same or similar names as those on the remote.
- “DVD” may be used as a general term for DVD VIDEOS, DVD+RWs/DVD+Rs, and DVD-RWs/DVD-Rs.
- The meaning of the icons used in this manual is described below:

Icon	Meaning
	Functions available for DVD VIDEOS and DVD+RWs/DVD+Rs or DVD-RWs/DVD-Rs in video mode
	Functions available for DVD-RWs in VR (Video Recording) mode
	Functions available for VIDEO CDs, Super VCDs, or CD-Rs/CD-RWs in video CD format or Super VCD format
	Functions available for DATA CDs (CD-ROMs/CD-Rs/CD-RWs containing MP3* audio tracks and JPEG image files)
	Functions available for music CDs or CD-Rs/CD-RWs in music CD format

* MP3 (MPEG 1 Audio Layer 3) is a standard format defined by ISO (International Standard Organization) /MPEG which compresses audio data.

This Player Can Play the Following Discs

Format of discs	
DVD VIDEO (page 74)	
DVD-RW (page 74)	
VIDEO CD	
Music CD	

“DVD VIDEO” and “DVD-RW” are trademarks.

Notes about CDs

The player can play the following discs: CD-ROMs/CD-Rs/CD-RWs recorded in the following formats:

- music CD format
- video CD format
- MP3 audio tracks and JPEG image files of format conforming to ISO9660* Level 1/ Level 2, or its extended format, Joliet
- KODAK Picture CD format

* A logical format of files and folders on CD-ROMs, defined by ISO (International Organization for Standardization).

Region code

Your player has a region code printed on the back of the unit and only will play DVD VIDEO discs (playback only) labeled with identical region codes. This system is used to protect copyrights.

DVD VIDEOS labeled  will also play on this player.

If you try to play any other DVD VIDEO, the message “Playback prohibited by area limitations.” will appear on the TV screen. Depending on the DVD VIDEO, no region code indication may be labeled even though playing the DVD VIDEO is prohibited by area restrictions.

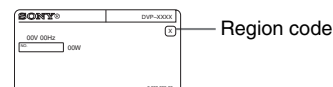

Example of discs that the player cannot play

The player cannot play the following discs:

- CD-ROMs (including PHOTO CDs)/CD-Rs/CD-RWs other than those recorded in the formats listed on the previous page.
- Data part of CD-Extras
- DVD-ROMs
- DVD Audio discs
- HD layer on Super Audio CDs

Also, the player cannot play the following discs:

- A DVD VIDEO with a different region code.
- A disc recorded in a color system other than NTSC, such as PAL or SECAM (this player conforms to the NTSC color system).
- A disc that has a non-standard shape (e.g., card, heart).
- A disc with paper or stickers on it.
- A disc that has the adhesive of cellophane tape or a sticker still left on it.

Notes

- **Notes about DVD+RWs/DVD+Rs, DVD-RWs/DVD-Rs or CD-Rs/CD-RWs**

Some DVD+RWs/DVD+Rs, DVD-RWs/DVD-Rs or CD-Rs/CD-RWs cannot be played on this player due to the recording quality or physical condition of the disc, or the characteristics of the recording device and authoring software.

The disc will not play if it has not been correctly finalized. For more information, see the operating instructions for the recording device. Note that some playback functions may not work with some DVD+RWs/DVD+Rs, even if they have been correctly finalized. In this case, view the disc by normal playback. Also some DATA CDs created in Packet Write format cannot be played.

- **Music discs encoded with copyright protection technologies**

This product is designed to playback discs that conform to the Compact Disc (CD) standard. Recently, various music discs encoded with copyright protection technologies are marketed by some record companies. Please be aware that among those discs, there are some that do not conform to the CD standard and may not be playable by this product.

Note on playback operations of DVDs and VIDEO CDs

Some playback operations of DVDs and VIDEO CDs may be intentionally set by software producers. Since this player plays DVDs and VIDEO CDs according to the disc contents the software producers designed, some playback features may not be available. Also, refer to the instructions supplied with the DVDs or VIDEO CDs.

Copyrights

This product incorporates copyright protection technology that is protected by U.S. patents and other intellectual property rights. Use of this copyright protection technology must be authorized by Macrovision, and is intended for home and other limited viewing uses only unless otherwise authorized by Macrovision. Reverse engineering or disassembly is prohibited.

Notes about the Discs

- To keep the disc clean, handle the disc by its edge. Do not touch the surface.



- Do not expose the disc to direct sunlight or heat sources such as hot air ducts, or leave it in a car parked in direct sunlight as the temperature may rise considerably inside the car.
- After playing, store the disc in its case.
- Clean the disc with a cleaning cloth. Wipe the disc from the center out.



- Do not use solvents such as benzene, thinner, commercially available cleaners, or anti-static spray intended for vinyl LPs.

Index to Parts and Controls

For more information, refer to the pages indicated in parentheses.

Front panel

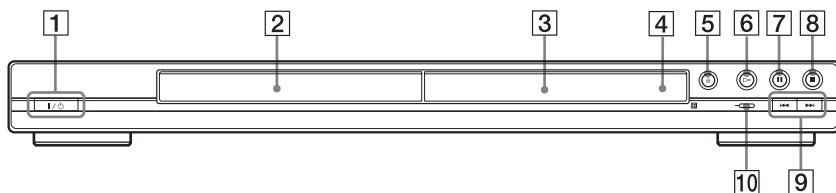



1 I/⏻ (on/standby) button (27)

2 Disc tray (27)

3 Front panel display (11)

4  (remote sensor) (17)

5  (open/close) button (27)

6  (play) button (27, 37)

7  (pause) button (28)

8  (stop) button (28)

9  (previous/next) buttons (37)

10 PROGRESSIVE indicator (19)

Lights up when the player outputs progressive signals.

Front panel display

When playing back a DVD VIDEO/DVD-RW

When playing back a VIDEO CD with Playback Control (PBC) (31)

When playing back a CD, DATA CD (MP3 audio), or VIDEO CD (without PBC)

Rear panel

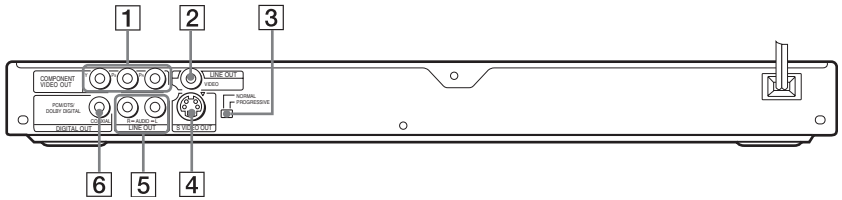

- 1** COMPONENT VIDEO OUT** jacks (18)
 - 2** LINE OUT (VIDEO)* jack (18)
 - 3** NORMAL/PROGRESSIVE switch (66)
 - 4** S VIDEO OUT* jack (18)
 - 5** LINE OUT L/R (AUDIO) jack (21, 22, 23)
 - 6** DIGITAL OUT (COAXIAL) jack (22, 23, 24)
- * Only set the “NORMAL/PROGRESSIVE” switch to “NORMAL” if you have connected the TV to these jacks (page 66)
- ** Set the “NORMAL/PROGRESSIVE” switch to “PROGRESSIVE” only if you have connected a progressive signal compatible TV to the player (page 66, 70)

Remote

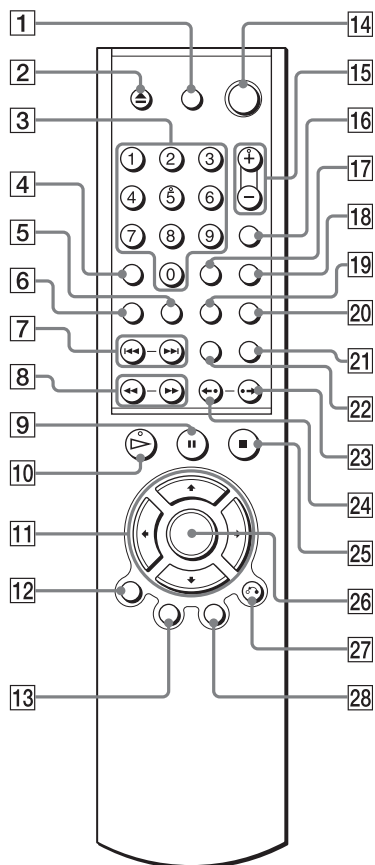

- 1** TV \mathbb{I}/\mathbb{C} (on/standby) button (62)
- 2** \blacktriangle OPEN/CLOSE button (27)
- 3** Number buttons (30)
The number 5 button has a tactile dot.*
- 4** CLEAR button (32)
- 5** SUBTITLE button (47)
- 6** AUDIO button (44)
- 7** $\mathbb{L}\mathbb{L}/\mathbb{R}\mathbb{R}$ PREV/NEXT (previous/next) buttons (28)
- 8** $\mathbb{L}\mathbb{L}\mathbb{L}/\mathbb{R}\mathbb{R}\mathbb{R}$ SCAN/SLOW buttons (37)
- 9** $\mathbb{I}\mathbb{I}$ PAUSE button (28)
- 10** \triangleright PLAY button (27)
The \triangleright button has a tactile dot.*
- 11** $\mathbb{L}/\mathbb{U}/\mathbb{D}/\mathbb{R}$ buttons (30)
- 12** DISPLAY button (14)
- 13** TOP MENU button (30)
- 14** \mathbb{I}/\mathbb{C} (on/standby) button (27)
- 15** VOL (volume) +/- buttons (62)
The + button has a tactile dot.*
- 16** TV/VIDEO button (62)
- 17** TIME/TEXT button (41)
- 18** PICTURE MODE button (48)
- 19** ANGLE button (47)
- 20** SUR (surround) button (45)
- 21** PICTURE NAVI (picture navigation) button (40, 53)
- 22** ZOOM button (28, 54)
- 23** $\bullet\rightarrow/\mathbb{I}\mathbb{I}$ INSTANT ADVANCE/STEP button (28, 37)
- 24** $\mathbb{L}\mathbb{L}/\mathbb{L}\mathbb{L}$ INSTANT REPLAY/STEP button (28, 37)
- 25** \blacksquare STOP button (28)
- 26** ENTER button (28)
- 27** \mathbb{C} RETURN button (28)
- 28** MENU button (30)

* Use the tactile dot as a reference when operating the player.

Guide to the Control Menu Display

Use the Control Menu to select a function and to view related information. Press DISPLAY repeatedly to turn on or change the Control Menu display as follows.

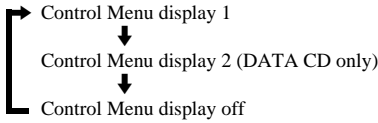

Control Menu Display

The Control Menu display 1 and 2 will show different items depending on the disc type. For details about each item, please refer to the pages in the parentheses.

Example: Control Menu display when playing a DVD VIDEO.

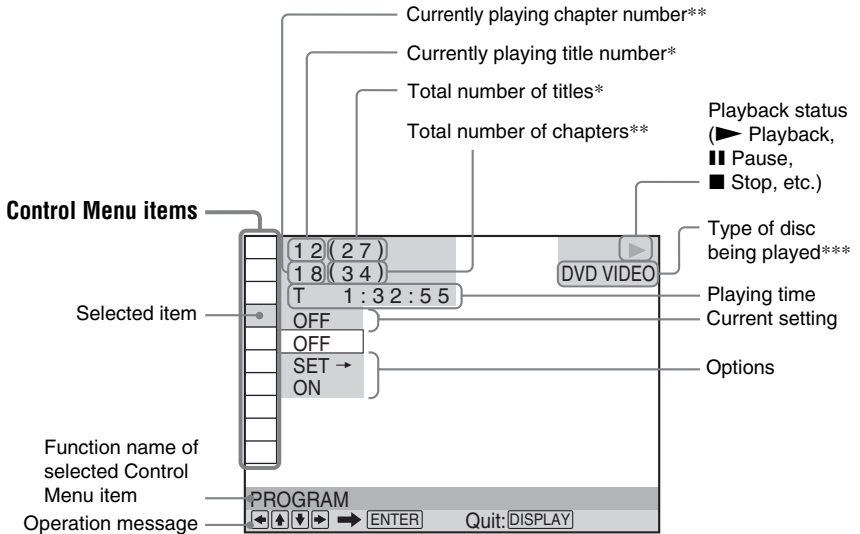

* Displays the scene number for VIDEO CDs (PBC is on), track number for VIDEO CDs/CDs, album number for DATA CDs.

















** Displays the index number for VIDEO CDs/CDs, MP3 audio track or JPEG image file number for DATA CDs.

*** Displays Super VCD as "SVCD."

To turn off the display

Press DISPLAY repeatedly.

List of Control Menu Items

Item	Item Name, Function, Relevant Disc Type
	TITLE (page 38)/SCENE (page 38)/TRACK (page 38) Selects the title, scene, or track to be played. DVD-V DVD-RW VCD
	CHAPTER (page 38)/INDEX (page 38) Selects the chapter or index to be played. DVD-V DVD-RW VCD
	ALBUM (page 38) Selects the album to be played. DATA CD
	DATE Displays the recorded date, etc of the current JPEG image. DATA CD
	FILE (page 38) Selects the JPEG image file to be played. DATA CD
	ORIGINAL/PLAY LIST (page 30) Selects the type of titles (DVD-RW) to be played, the ORIGINAL one, or an edited PLAY LIST. DVD-RW
	TRACK (page 38) Selects the track to be played. CD DATA CD
	TIME/TEXT (page 38) Checks the elapsed time and the remaining playback time. Input the time code for picture and music searching. Displays the DVD/CD text or the DATA CD's track name. DVD-V DVD-RW VCD CD DATA CD
	PROGRAM (page 32) Selects the title, chapter, or track to play in the order you want. DVD-V VCD CD
	SHUFFLE (page 34) Plays the title, chapter, or track in random order. DVD-V VCD CD
	REPEAT (page 35) Plays the entire disc (all titles/all tracks/all albums) repeatedly or one title/chapter/track/album repeatedly. DVD-V DVD-RW VCD CD DATA CD
	A-B REPEAT (page 36) Specifies the parts you want to play repeatedly. DVD-V DVD-RW VCD CD
	SHARPNESS (page 49) Exaggerates the outline of the image to produce a sharper picture. DVD-V DVD-RW VCD DATA CD
	MODE(MP3,JPEG) (page 53) Selects the data type; MP3 audio track (AUDIO), JPEG image file (IMAGE) or both (AUTO) to be played when playing a DATA CD. DATA CD
	INTERVAL (page 56) Specifies the duration for which the slides are displayed on the screen. DATA CD
	EFFECT (page 57) Selects the effect to be used when viewing the slideshow. DATA CD
	PARENTAL CONTROL (page 58) Set to prohibit playback on this player. DVD-V VCD CD



SETUP (page 63)

QUICK Setup (page 25)

Use Quick Setup to choose the desired language of the on-screen display, the aspect ratio of the TV and the audio output signal.

CUSTOM Setup

In addition to the Quick Setup setting, you can adjust other various settings.

RESET

Returns the settings in "SETUP" to the default setting.

DVD-V DVD-RW VCD CD DATA CD

Hint

The Control Menu icon indicator lights up in green

 →  when you select any item except "OFF," ("PROGRAM," "SHUFFLE,"

"REPEAT," "A-B REPEAT," "SHARPNESS"

only). The "ORIGINAL/PLAY LIST" indicator

lights up in green when "PLAY LIST" is selected.

Hooking Up the Player

Follow Steps 1 to 6 to hook up and adjust the settings of the player.

Notes

- Plug cords securely to prevent unwanted noise.
- Refer to the instructions supplied with the components to be connected.
- You cannot connect this player to a TV that does not have a video input jack.
- Be sure to disconnect the power cord of each component before connecting.

Step 1: Unpacking

Check that you have the following items:

- Audio/video cord (pinplug × 3 ↔ pinplug × 3) (1)
- Remote commander (remote) (1)
- Size AA (R6) batteries (2)
- A plug adapter is included with some models

Step 2: Inserting Batteries into the Remote

You can control the player using the supplied remote. Insert two Size AA (R6) batteries by matching the ⊕ and ⊖ ends on the batteries to the markings inside the compartment. When using the remote, point it at the remote sensor  on the player.

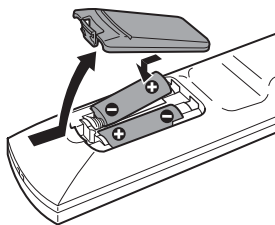

Notes

- Do not leave the remote in an extremely hot or humid place.
- Do not drop any foreign object into the remote casing, particularly when replacing the batteries.
- Do not expose the remote sensor to direct light from the sun or a lighting apparatus. Doing so may cause a malfunction.
- If you do not use the remote for an extended period of time, remove the batteries to avoid possible damage from battery leakage and corrosion.

Step 3: Connecting the Video Cords

Connect this player to your TV monitor, projector, or AV amplifier (receiver) using a video cord. Select one of the patterns **A** through **C**. In order to view progressive signal (480p) pictures with a compatible TV, projector, or monitor, you must use connection **C**, according to the input jack on your TV monitor, projector, or AV amplifier (receiver).

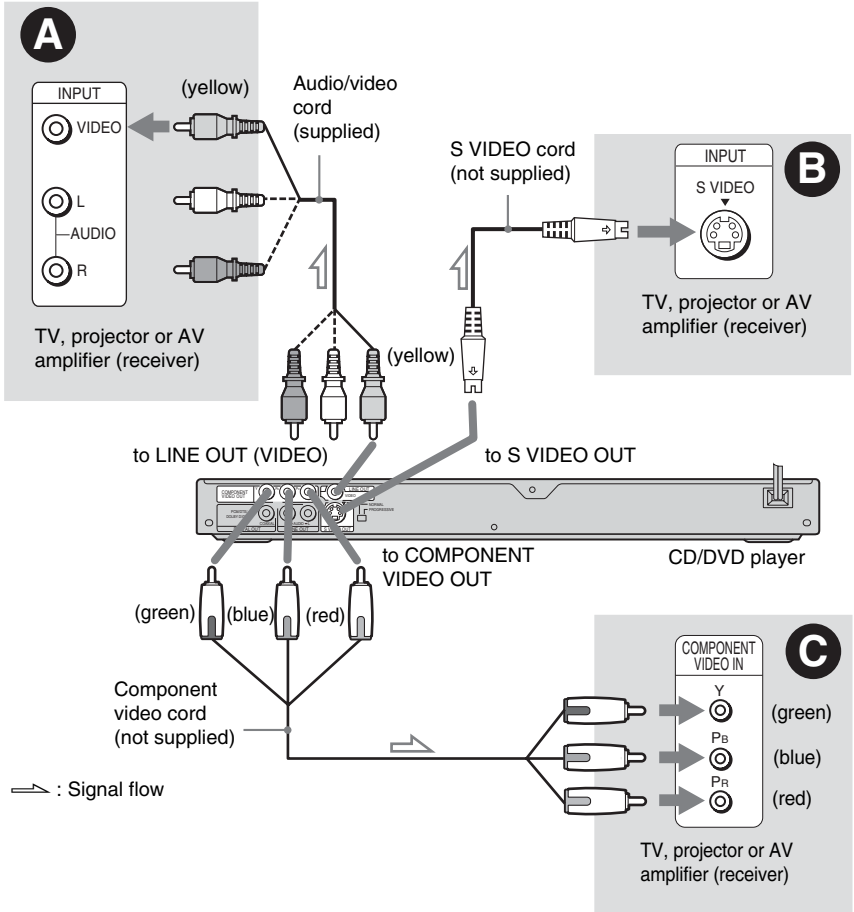

A If you are connecting to a video input jack

Connect the yellow plug of the audio/video cord (supplied) to the yellow (video) jack. You will enjoy standard quality images.

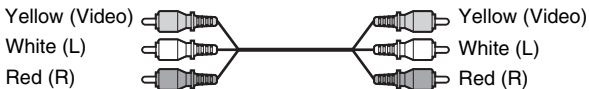

Use the red and white plugs to connect to the audio input jacks (page 21). (Do this if you are connecting to a TV only.)

B If you are connecting to an S VIDEO input jack

Connect an S VIDEO cord (not supplied). You will enjoy high quality images.



C If you are connecting to a monitor, projector, or AV amplifier (receiver) having component video input jacks (Y, P_B, P_R)

Connect the component via the COMPONENT VIDEO OUT jacks using a component video cord (not supplied) or three video cords (not supplied) of the same kind and length. You will enjoy accurate color reproduction and high quality images. If your TV accepts progressive (480p) format signals, you must use this connection and set NORMAL/PROGRESSIVE switch to PROGRESSIVE (page 66). The PROGRESSIVE indicator lights up when the player outputs progressive signals.



When connecting to a wide screen TV

Depending on the disc, the image may not fit your TV screen. If you want to change the aspect ratio, please refer to page 65.

Notes

- Connect the player directly to the TV. If you pass the player signals via the VCR, etc., you may not receive a clear image on the TV screen.

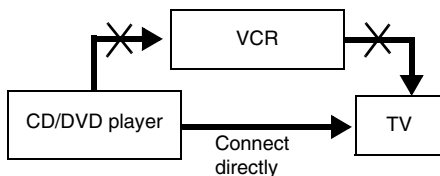

- Consumers should note that not all high definition television sets are fully compatible with this product and may cause artifacts to be displayed in the picture. In the case of 480 progressive scan picture problems, it is recommended that the user switch the connection to the 'standard definition' output. If there are questions regarding our TV set compatibility with this model 480p DVD player, please contact our customer service center.

Step 4: Connecting the Audio Cords

Refer to the chart below to select the connection that best suits your system. Be sure to also read the instructions for the components you wish to connect.

Select a connection

Select one of the following connections, **A** through **D**.

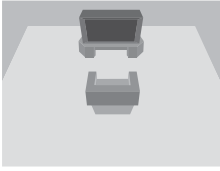
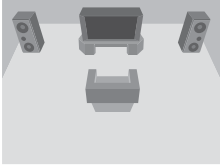
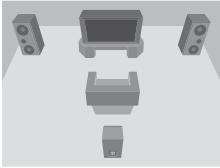
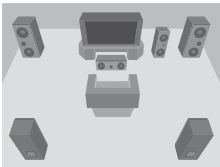
Components to be connected	Connection	Your setup (example)
<u>TV</u>	A (page 21)	
<u>Stereo amplifier (receiver) and two speakers</u> or <u>MD deck/DAT deck</u>	B (page 22)	
<u>AV amplifier (receiver) having a Dolby* Surround (Pro Logic) decoder and 3 to 6 speakers</u>	C (page 23)	
<u>AV amplifier (receiver) with digital input jacks having a Dolby Digital or DTS** decoder and 6 speakers</u>	D (page 24)	

Hint

If you connect an AV amplifier (receiver) that conforms to the 96 kHz sampling frequency, use connection **D**.

* Manufactured under license from Dolby Laboratories. "Dolby," "Pro Logic," and the double-D symbol are trademarks of Dolby Laboratories.

** "DTS" and "DTS Digital Out" are trademarks of Digital Theater Systems, Inc.

A Connecting to your TV

This connection will use your TV's speakers for sound.

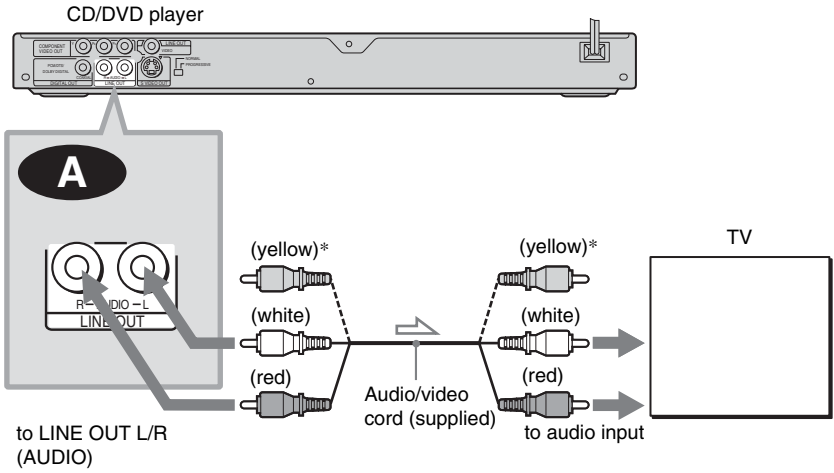

— : Signal flow

* The plug is used for video signals (page 18).

Hint

When connecting to a monaural TV, use a stereo-mono conversion cord (not supplied). Connect the LINE OUT L/R (AUDIO) jacks to the TV's audio input jack.

B Connecting to a stereo amplifier (receiver) and 2 speakers/Connecting to an MD deck or DAT deck

If the stereo amplifier (receiver) has audio input jacks L and R only, use **B-1**. If the amplifier (receiver) has a digital input jack, or when connecting to an MD deck or DAT deck, use **B-2**. In this case, you can also connect the player directly to the MD deck or DAT deck without using your stereo amplifier (receiver).

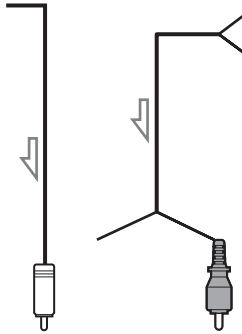
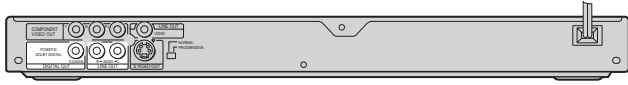

C Connecting to an AV amplifier (receiver) having a Dolby Surround (Pro Logic) decoder and 3 to 6 speakers

You can enjoy the Dolby Surround effects only when playing Dolby Surround audio or multi-channel audio (Dolby Digital) discs.

If your amplifier (receiver) has L and R audio input jacks only, use **C-1**. If your amplifier (receiver) has a digital input jack, use **C-2**.

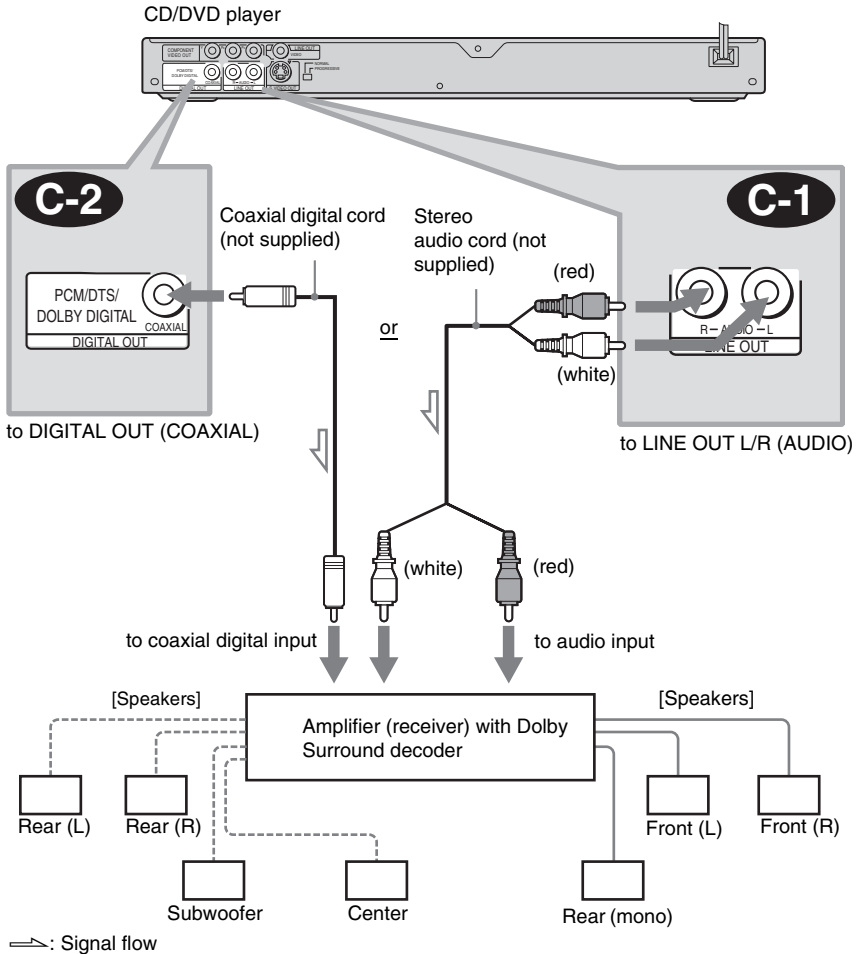

Note

When connecting 6 speakers, replace the monaural rear speaker with a center speaker, 2 rear speakers and a subwoofer.

D Connecting to an AV amplifier (receiver) with a digital input jack having a Dolby Digital or DTS decoder and 6 speakers

This connection will allow you to use the Dolby Digital or DTS decoder function of your AV amplifier (receiver).

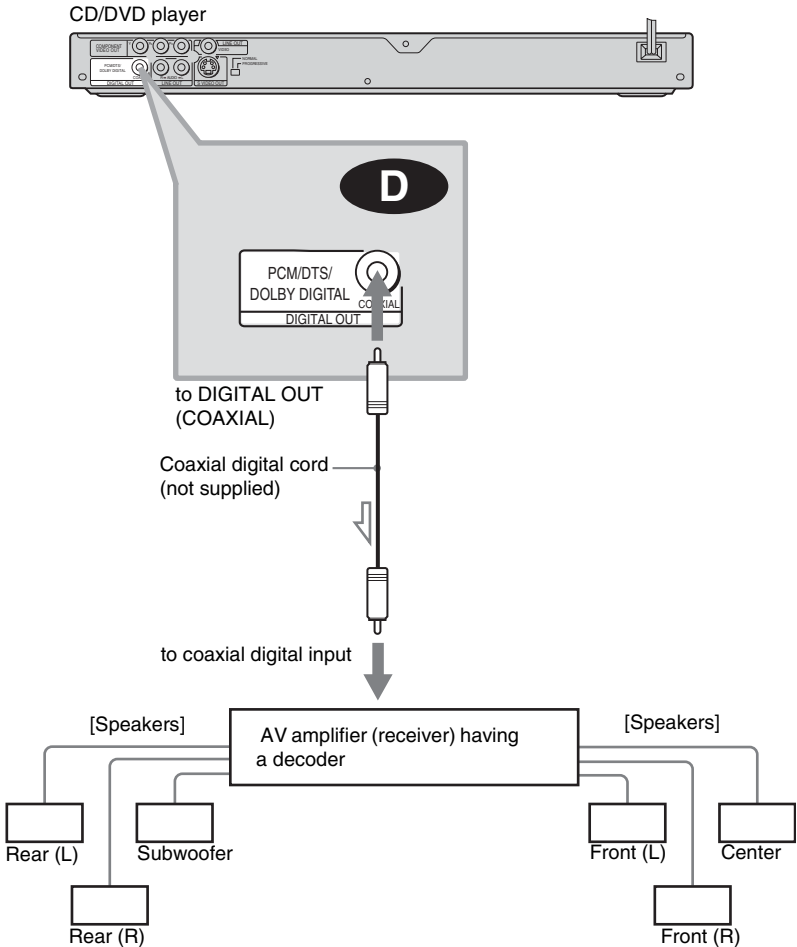

⇒: Signal flow

Hint

Use connection **D** when connecting to 7 or more speakers (6.1 ch or more).

Notes

- After you have completed the connection, be sure to set "DOLBY DIGITAL" to "DOLBY DIGITAL" and "DTS" to "ON" in Quick Setup (page 25).

- In order to listen to DTS sound tracks, you must use this connection. DTS sound tracks are not output through the LINE OUT L/R (AUDIO) jacks, even if you set "DTS" to "ON" in Quick Setup (page 25).
- When you connect an amplifier (receiver) that conforms to the 96 kHz sampling frequency, set "48kHz/96kHz PCM" in "AUDIO SETUP" to "96kHz/24bit" (page 69).

Step 5: Connecting the Power Cord

Plug the player and TV power cords into an AC outlet.

Step 6: Quick Setup

Follow the steps below to make the minimum number of basic adjustments for using the player. To skip an adjustment, press **▶▶▶**. To return to the previous adjustment, press **◀◀◀**.

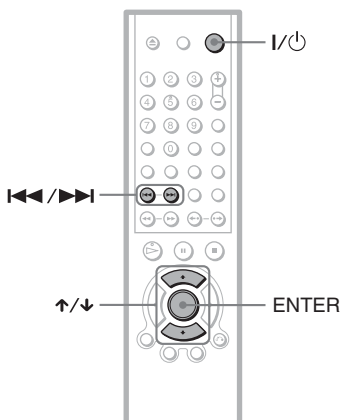

1 Turn on the TV.

2 Press I/Power.

3 Switch the input selector on your TV so that the signal from the player appears on the TV screen.

“Press [ENTER] to run QUICK SETUP” appears at the bottom of the screen. If this message does not appear, select “QUICK” under “SETUP” in the Control Menu to run Quick Setup (page 64).

4 Press ENTER without inserting a disc.

The Setup Display for selecting the language used in the on-screen display appears.

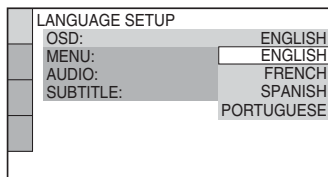

5 Press **↑/↓** to select a language.

The player uses the language selected here to display the menu and subtitles as well.

6 Press ENTER.

The Setup Display for selecting the aspect ratio of the TV to be connected appears.

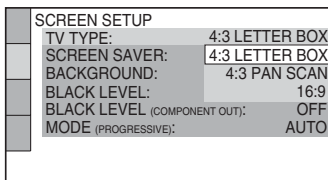

7 Press **↑/↓** to select the setting that matches your TV type.

◆ If you have a 4:3 standard TV

- 4:3 LETTER BOX or 4:3 PAN SCAN (page 65)

◆ If you have a wide-screen TV or a 4:3 standard TV with a wide-screen mode

- 16:9 (page 65)

8 Press ENTER.

The Setup Display for selecting the type of jack used to connect your amplifier (receiver) appears.

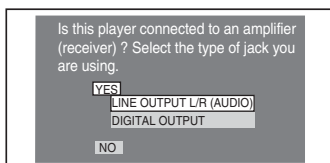

9 Press **↑/↓** to select the type of jack (if any) you are using to connect to an amplifier (receiver), then press **ENTER**.

Choose the item that matches the audio connection you selected on pages 21 to 24 (**A** through **D**).

- A**
- If you connect just a TV and nothing else, select “NO.” Quick Setup is finished and connections are complete.

- B-1 C-1**
- Select “LINE OUTPUT L/R (AUDIO).” Quick Setup is finished and connections are complete.

- B-2 C-2 D**
- Select “DIGITAL OUTPUT.” The Setup Display for “DOLBY DIGITAL” appears.

10 Press **↑/↓** to select the type of Dolby Digital signal you wish to send to your amplifier (receiver).

Choose the signal that matches the audio connection you selected on pages 22 to 24 (**B** through **D**).

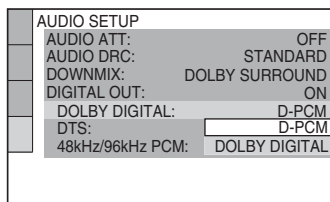

- B-2 C-2**
- D-PCM (page 69)
- D**
- DOLBY DIGITAL (only if the amplifier (receiver) has a Dolby Digital decoder) (page 69)

11 Press **ENTER**.

“DTS” is selected.

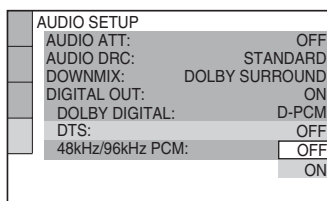

12 Press **↑/↓** to select whether or not you wish to send a DTS signal to your amplifier (receiver).

Choose the item that matches the audio connection you selected on pages 22 to 24 (**B** through **D**).

- B-2 C-2**
- OFF (page 69)
- D**
- ON (only if the amplifier (receiver) has a DTS decoder) (page 69)

13 Press **ENTER**.

Quick Setup is finished. All connections and setup operations are complete.

Enjoying the surround sound effects

To enjoy the surround sound effects of this player or your amplifier (receiver), set the following items as described below for the audio connection you selected on pages 22 to 24 (**B** through **D**). Each of these is the default setting and does not need to be adjusted when you first connect the player. Refer to page 63 for using the Setup Display.

Audio Connection (pages 21 to 24)

- A**
- No additional settings are needed.
- B-1 C-1**
- Set “DOWNMIX” to “DOLBY SURROUND” (page 68)
- If the sound distorts even when the volume is turned down, set “AUDIO ATT” to “ON” (page 68)
- B-2 C-2 D**
- Set “DOWNMIX” to “DOLBY SURROUND” (page 68)
- Set “DIGITAL OUT” to “ON” (page 68)

Playing Discs

DVD-V DVD-RW VCD CD DATA CD

Depending on the DVD or VIDEO CD, some operations may be different or restricted. Refer to the operating instructions supplied with your disc.

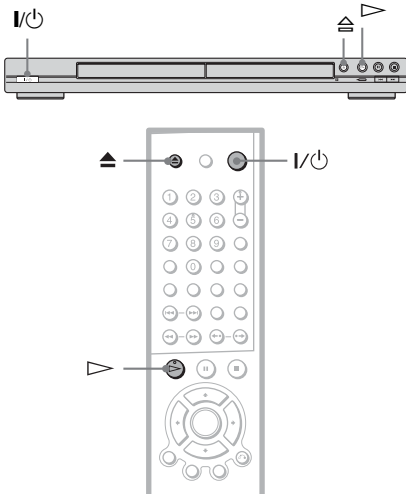

1 Turn on your TV.

2 Press I/⏻.

The player turns on.

3 Switch the input selector on your TV so that the signal from the player appears on the TV screen.

◆ **When using an amplifier (receiver)**

Turn on the amplifier (receiver) and select the appropriate channel so that you can hear sound from the player.

4 Press ⏻ on the player, and place a disc on the disc tray.

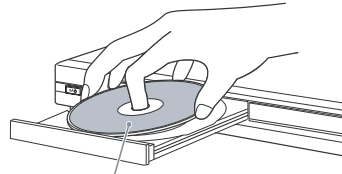

With the playback side facing down

5 Press ▶.

The disc tray closes, and the player starts playback (continuous play). Adjust the volume on the TV or the amplifier (receiver).

Depending on the disc, a menu may appear on the TV screen. For DVD VIDEOS, see page 30. For VIDEO CDs, see page 31.

To turn off the player

Press I/⏻. The player enters standby mode.

💡 Hint

You can have the player turn off automatically whenever you leave it in stop mode for more than 30 minutes. To turn on this function, set "AUTO POWER OFF" in "CUSTOM SETUP" to "ON" (page 67).

Additional operations

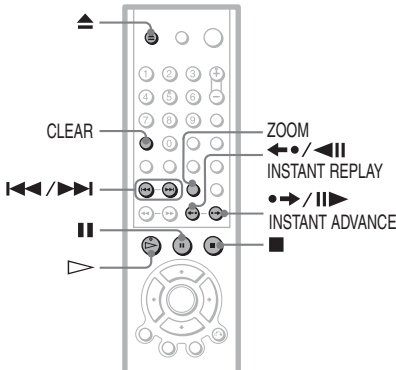

To	Operation
Stop	Press ■
Pause	Press
Resume play after pause	Press or ▷
Go to the next chapter, track, or scene in continuous play mode	Press ►►
Go back to the previous chapter, track, or scene in continuous play mode	Press ◀◀
Stop play and remove the disc	Press ▲
Replay the previous scene*	Press ◀•/◀ INSTANT REPLAY during playback
Briefly fast forward the current scene**	Press •►/ ▶ INSTANT ADVANCE during playback
Magnify the image***	Press ZOOM repeatedly. Press CLEAR to cancel.

* For DVD VIDEOS and DVD-RWs/DVD-Rs only

** For DVD VIDEOS and DVD-RWs/DVD-Rs or DVD+RWs only

***For Video and JPEG pictures only (except BACKGROUND pictures). You can move the enlarged picture using ◀/↑/↓/▶. Depending upon the contents of the disc, the ZOOM function may be canceled automatically when the picture is moved.

Hints

- The Instant Replay function is useful when you want to review a scene or dialog that you missed.
- The Instant Advance function is useful when you want to pass over a scene that you don't want to watch.

Note

You may not be able to use the Instant Replay or Instant Advance function with some scenes.

Locking the disc tray (Child Lock)

You can lock the disc tray to prevent children from opening it.

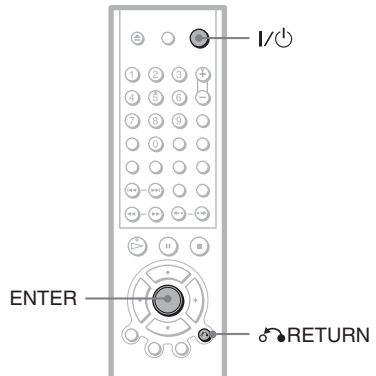

When the player is in standby mode, press ◀ RETURN, ENTER, and then I/ON on the remote.

The player turns on and "LOCKED" appears on the front panel display.

The ▲ button on the player or the remote does not work while the Child Lock is set.

To unlock the disc tray

When the player is in standby mode, press ◀ RETURN, ENTER, and then I/ON again.

Note

Even if you select "RESET" under "SETUP" in the Control Menu (page 64), the disc tray remains locked.

Resuming Playback from the Point Where You Stopped the Disc

(Multi-disc Resume) **DVD-V** **VCD**

The player stores the point where you stopped the disc for up to 6 discs and resumes playback the next time you insert the same disc. When you store a resume playback point for the seventh disc, the resume playback point for the first disc is deleted.

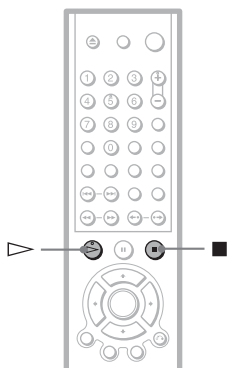

- The resume playback point for the current disc is cleared when:
 - you change the play mode.
 - you change the settings on the Setup Display.
- This function may not work with some discs.
- Resume Play does not work during Shuffle Play and Program Play.
- If “MULTI-DISC RESUME” in “CUSTOM SETUP” is set to “ON” and you playback a recorded disc such as DVD-RW, the player may playback other recorded discs from the same resume point. To play from the beginning, press ■ twice and then press ▷.

1 While playing a disc, press ■ to stop playback.

“RESUME” appears on the front panel display.

2 Press ▷.

The player starts playback from the point where you stopped the disc in Step 1.

💡 Hints

- To play from the beginning of the disc, press ■ twice, then press ▷.
- For DVD-RWs in VR mode, CDs, and DATA CDs, the player remembers the resume playback point for the current disc unless the disc tray is opened, the power cord is disconnected, or only for DATA CDs, the player enters standby mode.

Notes

- “MULTI-DISC RESUME” in “CUSTOM SETUP” must be set to “ON” (default) for this function to work (page 67).

Using the DVD's Menu

DVD-V

A DVD is divided into long sections of a picture or a music feature called "titles." When you play a DVD which contains several titles, you can select the title you want using the TOP MENU button. When you play DVDs that allow you to select items such as the language for the subtitles and the language for the sound, select these items using the MENU button.

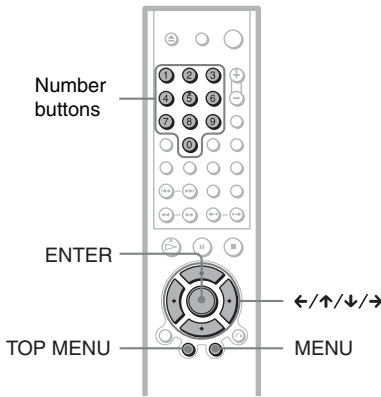

1 Press TOP MENU or MENU.

The disc's menu appears on the TV screen. The contents of the menu vary from disc to disc.

2 Press ←/↑/↓/→ or the number buttons to select the item you want to play or change.

If you press the number buttons, the following display appears. Press the number buttons to select the item you want.

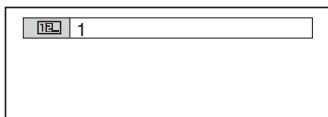

3 Press ENTER.

Selecting "ORIGINAL" or "PLAY LIST" on a DVD-RW Disc

DVD-RW

Some DVD-RW discs in VR (Video Recording) mode have two types of titles for playback: originally recorded titles (ORIGINAL) and titles that can be created on recordable DVD players for editing (PLAY LIST). You can select the type of titles to be played.

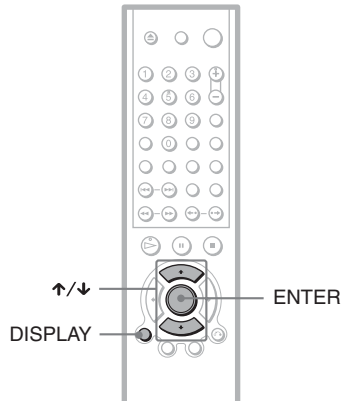

1 Press DISPLAY in stop mode.

The Control Menu appears.

2 Press ↑/↓ to select (ORIGINAL/PLAY LIST), then press ENTER.

The options for "ORIGINAL/PLAY LIST" appear.

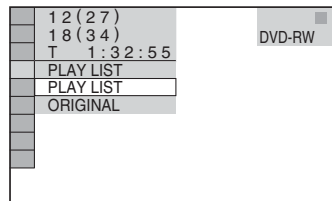

Hint

To play without using PBC, press **◀◀/▶▶** or the number buttons while the player is stopped to select a track, then press **▷** or **ENTER**.

“Play without PBC” appears on the TV screen and the player starts continuous play. You cannot play still pictures such as a menu.

To return to PBC playback, press **■** twice then press **▷**.

Note

Depending on the VIDEO CD, “Press ENTER” in Step 3 may appear as “Press SELECT” in the instructions supplied with the disc. In this case, press **▷**.

Various Play Mode Functions (Program Play, Shuffle Play, Repeat Play, A-B Repeat Play)

You can set the following play modes:

- Program Play (page 32)
- Shuffle Play (page 34)
- Repeat Play (page 35)
- A-B Repeat Play (page 36)

Note

The play mode is canceled when:

- you open the disc tray.
- the player enters standby mode by pressing **I/O**.

Creating your own program (Program Play) **DVD-V** **VCD** **CD**

You can play the contents of a disc in the order you want by arranging the order of the titles, chapters, or tracks on the disc to create your own program. You can program up to 99 titles, chapters, and tracks.

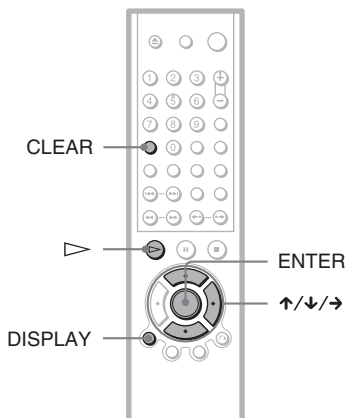

1 Press **DISPLAY**.

The Control Menu appears.

2 Press **↑/↓** to select **PROGRAM**, then press **ENTER**.

The options for “PROGRAM” appear.

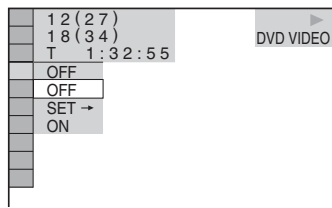

3 Press \uparrow/\downarrow to select "SET \rightarrow ," then press ENTER.

"TRACK" is displayed when you play a VIDEO CD or CD.

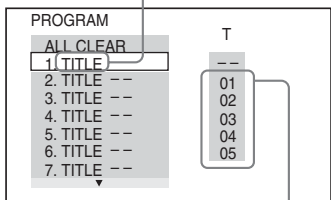

Titles or tracks recorded on a disc

4 Press \rightarrow .

The cursor moves to the title or track row "T" (in this case, "01").

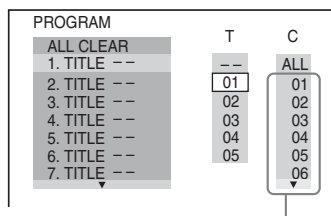

Chapters recorded on a disc

5 Select the title, chapter, or track you want to program.

◆ When playing a DVD VIDEO

For example, select chapter "03" of title "02."

Press \uparrow/\downarrow to select "02" under "T," then press ENTER.

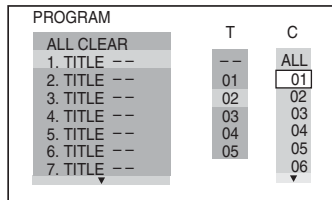

Next, press \uparrow/\downarrow to select "03" under "C," then press ENTER.

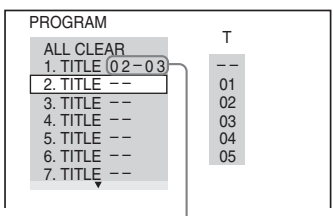

Selected title and chapter

◆ When playing a VIDEO CD or CD

For example, select track "02."

Press \uparrow/\downarrow to select "02" under "T," then press ENTER.

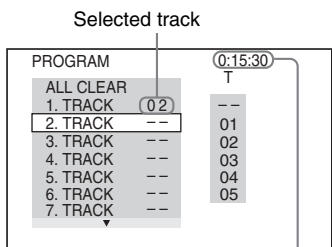

Total time of the programmed tracks

6 To program other titles, chapters, or tracks, repeat Steps 4 to 5.

The programmed titles, chapters, and tracks are displayed in the selected order.

7 Press \triangleright to start Program Play.

Program Play begins.

When the program ends, you can restart the same program again by pressing \triangleleft .

To return to normal play

Press CLEAR, or select "OFF" in Step 3. To play the same program again, select "ON" in Step 3 and press ENTER.

To change or cancel a program

- 1** Follow Steps 1 through 3 of "Creating your own program (Program Play)."
- 2** Select the program number of the title, chapter, or track you want to change or cancel using \uparrow/\downarrow , and press \rightarrow .
- 3** Follow Step 5 for new programming. To cancel a program, select "--" under "T," then press ENTER.

To cancel all of the titles, chapters, or tracks in the programmed order

- 1 Follow Steps 1 through 3 of “Creating your own program (Program Play).”
- 2 Press **↑** and select “ALL CLEAR.”
- 3 Press **ENTER**.

Hint

You can do Repeat Play or Shuffle Play of the programmed titles, chapters, or tracks. During Program Play, follow the Steps of “Repeat Play” (page 35) or “Shuffle Play” (page 34).

Note

You cannot use this function with VIDEO CDs and Super VCD with PBC playback.

Playing in random order (Shuffle Play) **DVD-V** **VCD** **CD**

You can have the player “shuffle” titles, chapters, or tracks. Subsequent “shuffling” may produce a different playing order.

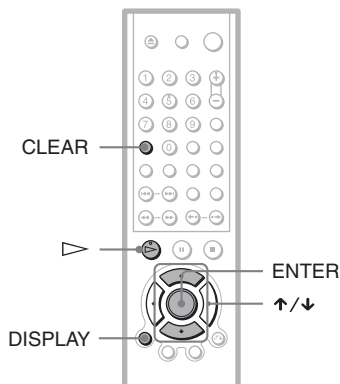

- 1 Press **DISPLAY** during playback.
The Control Menu appears.
- 2 Press **↑/↓** to select  **(SHUFFLE)**, then press **ENTER**.
The options for “SHUFFLE” appear.

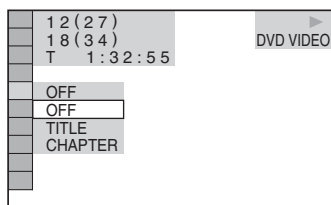

- 3 Press **↑/↓** to select the item to be shuffled.

◆ When playing a DVD VIDEO

- TITLE
- CHAPTER

◆ When playing a VIDEO CD or CD

- TRACK

◆ When Program Play is activated

- ON: shuffles titles, chapters, or tracks selected in Program Play.

- 4 Press **ENTER**.

Shuffle Play starts.

To return to normal play

Press **CLEAR**, or select “OFF” in Step 3.

Hints

- You can set Shuffle Play while the player is stopped. After selecting the “SHUFFLE” option, press **▷**. Shuffle Play starts.
- Up to 200 chapters in a disc can be played in random order when “CHAPTER” is selected.

Note

You cannot use this function with VIDEO CDs and Super VCD with PBC playback.

Playing repeatedly (Repeat Play)

DVD-V DVD-RW VCD CD DATA CD

You can play all of the titles or tracks on a disc or a single title, chapter, or track repeatedly.

You can use a combination of Shuffle or Program Play modes.

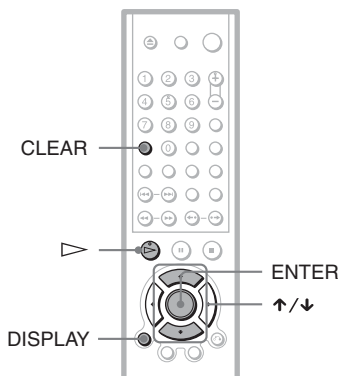

1 Press DISPLAY during playback.

The Control Menu appears.

2 Press \uparrow/\downarrow to select , then press ENTER.

The options for "REPEAT" appear.

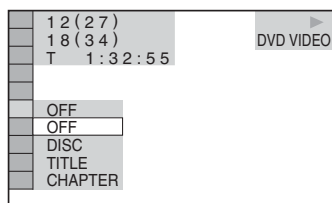

◆ When playing a DVD VIDEO

- DISC: repeats all of the titles.
- TITLE: repeats the current title on a disc.
- CHAPTER: repeats the current chapter.

◆ When playing a DVD-RW

- DISC: repeats all the titles of the selected type.
- TITLE: repeats the current title on a disc.
- CHAPTER: repeats the current chapter.

◆ When playing a VIDEO CD or CD

- DISC: repeats all of the tracks.
- TRACK: repeats the current track.

◆ When playing a DATA CD (MP3 audio)

- DISC: repeats all of the albums.
- ALBUM: repeats the current album.
- TRACK: repeats the current track.

◆ When playing a DATA CD (JPEG image)

- DISC: repeats all of the albums.
- ALBUM: repeats the current album.

◆ When playing a DATA CD (MP3 audio and JPEG image)

- DISC: repeats all of the albums.
- ALBUM: repeats the current album.
- TRACK: repeats the current track (MP3 audio).

◆ When Program Play or Shuffle Play is activated

- ON: repeats Program Play or Shuffle Play.

To return to normal play

Press CLEAR, or select "OFF" in Step 2.

Hint

You can set Repeat Play while the player is stopped. After selecting the "REPEAT" option, press \triangleright . Repeat Play starts.

Notes

- You cannot use this function with VIDEO CDs and Super VCD with PBC playback.
- When playing a DATA CD which contains MP3 audio tracks and JPEG image files, and their playing time are not the same, the audio sound will not match the image file as it is repeated.

Repeating a specific portion (A-B Repeat Play)

You can play a specific portion of a title, chapter or track repeatedly. (This function is useful when you want to memorize lyrics, etc.)

- 1 Press DISPLAY during playback.**
The Control Menu appears.
- 2 Press \uparrow/\downarrow to select (A-B REPEAT), then press ENTER.**
The options for “A-B REPEAT” appear.



N-1

- 3 Press \uparrow/\downarrow**

Searching for a Scene

Searching for a Particular Point on a Disc (Search, Scan, Slow-motion Play, Freeze Frame)

You can quickly locate a particular point on a disc by monitoring the picture or playing back slowly.

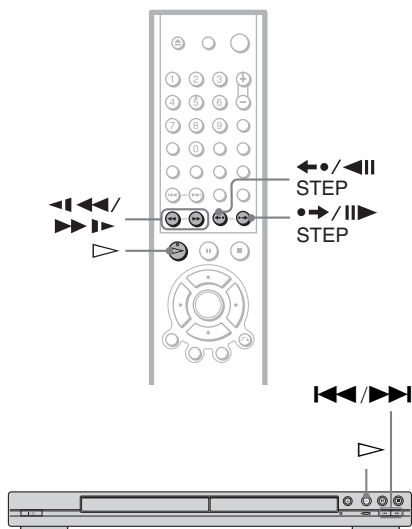

Notes

- Depending on the DVD/VIDEO CD, you may not be able to do some of the operations described.
- For DATA CDs, you can search for a particular point only on an MP3 audio track.

Locating a point quickly using the PREV (previous)/NEXT (next) buttons (Search)

CD DATA CD

You can search for a particular point on a disc using **◀◀/▶▶** on the player. During playback, press and hold **▶▶** to locate a point in the playback direction or press and hold **◀◀** to locate a point in the opposite direction. When you find the point you want, release the button to return to normal playback speed.

Locating a point quickly by playing a disc in fast forward or fast reverse (Scan)

DVD-V DVD-RW

VCD CD DATA CD

Press **◀◀◀◀** or **▶▶▶▶** while playing a disc. When you find the point you want, press **▷** to return to normal speed. Each time you press **◀◀◀◀** or **▶▶▶▶** during scan, the playback speed changes. With each press the indication changes as shown below. Actual speeds may differ with some discs.

Playback direction



Opposite direction



The “ $\times 2 \gg$ ”/ “ $\times 2 \ll$ ” playback speed is about twice the normal speed. The “ $3 \gg \gg$ ”/ “ $3 \ll \ll$ ” playback speed is faster than “ $2 \gg \gg$ ”/ “ $2 \ll \ll$ ” and the “ $2 \gg \gg$ ”/ “ $2 \ll \ll$ ” playback speed is faster than “ $1 \gg \gg$ ”/ “ $1 \ll \ll$ ”.

Watching frame by frame (Slow-motion play)

DVD-V DVD-RW VCD

Press **◀◀◀◀** or **▶▶▶▶** when the player is in pause mode. To return to the normal speed, press **▷**. Each time you press **◀◀◀◀** or **▶▶▶▶** during Slow-motion play, the playback speed changes. Two speeds are available. With each press the indication changes as follows:

Playback direction

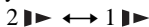

Opposite direction (DVD only)

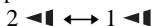

The “ $2 \gg$ ”/ “ $2 \ll$ ” playback speed is slower than “ $1 \gg$ ”/ “ $1 \ll$ ”.

Playing one frame at a time

(Freeze Frame) **DVD-V DVD-RW VCD**

When the player is in the pause mode, press **•→/II▶ STEP** to go to the next frame. Press **←•/◀II STEP** to go to the preceding frame (DVD only). To return to normal playback, press **▷**.

Note

You cannot search for a still picture on a DVD-RW in VR mode.

Searching for a Title/Chapter/Track/Scene, etc.

DVD-V DVD-RW VCD CD

DATA CD

You can search a DVD by title or chapter, and you can search a VIDEO CD/CD/DATA CD by track, index, or scene. As titles and tracks are assigned unique numbers on the disc, you can select the desired one by entering its number. Or, you can search for a scene using the time code.

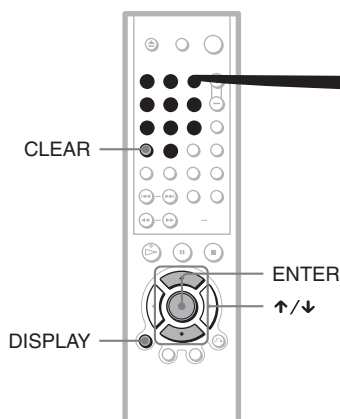

- 1 Press DISPLAY. (When playing a DATA CD with JPEG image files, press DISPLAY twice.)**

The Control Menu appears.

- 2 Press ↑/↓ to select the search method.**

- ◆ When playing a DVD VIDEO/DVD-RW
 - TITLE
 - CHAPTER
 - TIME/TEXT

Select "TIME/TEXT" to search for a starting point by inputting the time code.

◆ When playing a VIDEO CD or Super VCD without PBC Playback



TRACK



INDEX

◆ When playing a VIDEO CD or Super VCD with PBC Playback



SCENE



INDEX

◆ When playing a CD

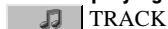

TRACK

◆ When playing a DATA CD (MP3 audio)



ALBUM



TRACK

◆ When viewing a DATA CD (JPEG image)



ALBUM



FILE

Example: when you select CHAPTER

“** (**)” is selected (** refers to a number).

The number in parentheses indicates the total number of titles, chapters, tracks, indexes, scenes, albums or files.

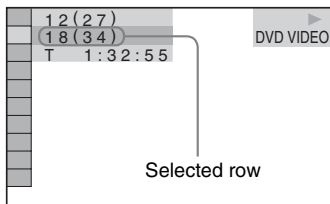

3 Press ENTER.

“** (**)” changes to “_ (**).”

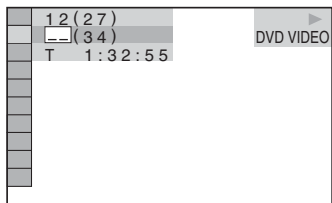

4 Press the number buttons to select the title, chapter, track, index, scene, etc., number you want to search.

If you make a mistake

Cancel the number by pressing CLEAR, then select another number.

5 Press ENTER.

The player starts playback from the selected number.

To search for a scene using the time code (DVD VIDEO/DVD-RW only)

1 In Step 2, select TIME/TEXT. “T **: **: : **” (playing time of the current title) is selected.

2 Press ENTER. “T **: **: : **” changes to “T --:--:--.”

3 Input the time code using the number buttons, then press ENTER. For example, to find the scene at 2 hours, 10 minutes, and 20 seconds after the beginning, just enter “2:10:20.”

Hints

- When the Control Menu display is turned off, you can search for a chapter (DVD VIDEO/DVD-RW) or track (CD) by pressing the number buttons and ENTER.
- You can display the first scene of titles, chapters, or tracks recorded on the disc on a screen divided into 9 sections. You can start playback directly by selecting one of the scenes. For details, see “Searching by Scene (PICTURE NAVIGATION)” on the next page.

Notes

- The title, chapter, or track number displayed is the same number recorded on the disc.
- You cannot search for a scene on a DVD+RW using the time code.

Searching by Scene

(PICTURE NAVIGATION) **DVD-V** **VCD**

You can divide the screen into 9 subscreens and quickly find the desired scene.

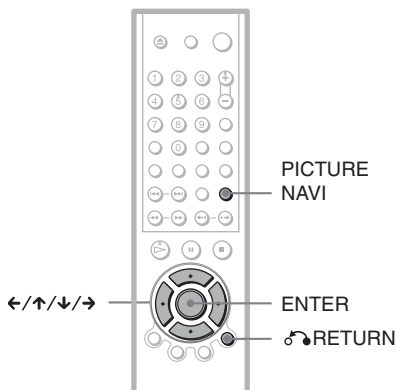

1 Press PICTURE NAVI during playback.

The following display appears.

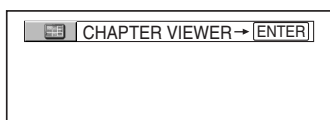

2 Press PICTURE NAVI repeatedly to select an item.

- CHAPTER VIEWER (DVD VIDEO only)
- TITLE VIEWER (DVD VIDEO only)
- TRACK VIEWER (VIDEO CD only)

3 Press ENTER.

The following display appears.

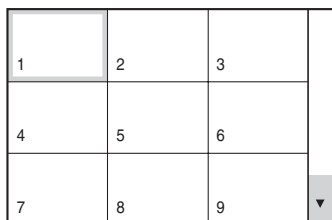

4 Press ←/↑/↓/→ to select a title, chapter, or track, and press ENTER.

Playback starts.

Hint

If there are more than 9 titles, chapters, or tracks, ▼ is displayed at the bottom right of the screen. To display the additional titles, chapters, or tracks, select the bottom scene and press ↓. To return to the previous scene, select the top scene and press ↑.

Note

Depending on the disc, you may not be able to select some items.

Viewing Information About the Disc

Checking the Playing Time and Remaining Time

Time DVD-V DVD-RW VCD CD

DATA CD

You can check the playing time and remaining time of the current title, chapter, or track. Also, you can check the DVD/CD text or track name (MP3 audio) recorded on the disc.

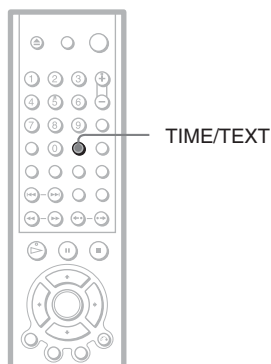

1 Press TIME/TEXT during playback.

The following display appears.

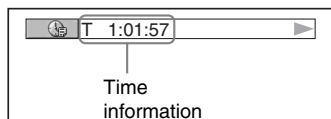

2 Press TIME/TEXT repeatedly to change the time information.

The available time information depends upon the type of disc you are playing.

◆ When playing a DVD VIDEO or DVD-RW

- T *:*: (hours: minutes: seconds)
Playing time of the current title
- T-*:*:
Remaining time of the current title
- C *:*:
Playing time of the current chapter
- C-*:*:
Remaining time of the current chapter

◆ When playing a VIDEO CD or Super VCD (with PBC functions)

- *:* (minutes: seconds)
Playing time of the current scene

◆ When playing a VIDEO CD (without PBC functions) or CD

- T *:* (minutes: seconds)
Playing time of the current track
- T-*:*
Remaining time of the current track
- D *:*
Playing time of the current disc
- D-*:*
Remaining time of the current disc

◆ When playing a Super VCD (without PBC functions)

- T *:* (minutes: seconds)
Playing time of the current track

◆ When playing a DATA CD (MP3 audio)

- T *:* (minutes: seconds)
Playing time of the current track

Checking the play information of the Disc

To check DVD/CD text

Press TIME/TEXT repeatedly in Step 2 to display text recorded on the DVD/CD. The DVD/CD text appears only when text is recorded in the disc. You cannot change the text. If the disc does not contain text, "NO TEXT" appears.

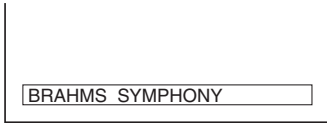

To check DATA CD (MP3 audio) text

By pressing TIME/TEXT while playing MP3 audio tracks on a DATA CD, the track name and album name appear. You can also display the audio bit rate (the amount of data per second of the current audio) on your TV screen.

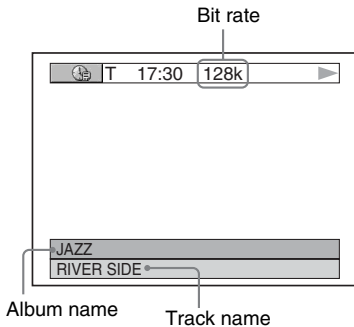

Checking the information on the front panel display

You can view the time information and text displayed on the TV screen also on the front panel display. The information on the front panel display changes as follows when you change the time information on your TV screen.

When playing a DVD VIDEO or DVD-RW

Playing time of the current title



Remaining time of the current title

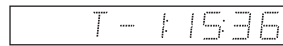

Playing time of the current chapter

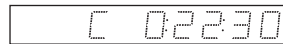

Remaining time of the current chapter

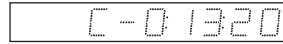

Text



Current title and chapter number



(returns to top automatically)

When playing a DATA CD (MP3 audio)

Playing time and number of the current track

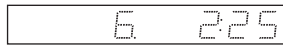

Track name



When playing a VIDEO CD (without PBC functions) or CD

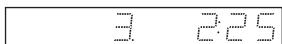

3 225



3 - 15

Hints

- When playing VIDEO CDs without PBC functions, the track number and the index number are displayed after the text.
- When playing VIDEO CDs with PBC functions, the scene number and the playing time are displayed.
- Long text that does not fit in a single line will scroll across the front panel display.
- You can also check the time information and text using the Control Menu (page 14).

Notes

- Depending on the type of disc being played, the DVD/CD text or track name may not be displayed.
- The player can only display the first level of the DVD/CD text, such as the disc name or title.
- Playing time of MP3 audio tracks may not be displayed correctly.
- If you play a disc containing JPEG image file only, the “NO AUDIO DATA” message appears on the front panel display.

Changing the Sound

DVD-V DVD-RW VCD CD

DATA CD

When playing a DVD VIDEO recorded in multiple audio formats (PCM, Dolby Digital, or DTS), you can change the audio format. If the DVD VIDEO is recorded with multilingual tracks, you can also change the language.

With CDs, DATA CDs, or VIDEO CDs, you can select the sound from the right or left channel and listen to the sound of the selected channel through both the right and left speakers. For example, when playing a disc containing a song with the vocals on the right channel and the instruments on the left channel, you can hear the instruments from both speakers by selecting the left channel.

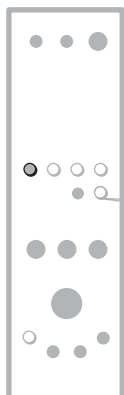

1 Press **AUDIO** during playback.

The following display appears.

2 Press **AUDIO** repeatedly to select the desired audio signal.

◆ When playing a DVD VIDEO

Depending on the DVD VIDEO, the choice of language varies.

When 4 digits are displayed, they indicate a language code. Refer to “Language Code List” on page 77 to see which language the code represents. When the same language is displayed two or more times, the DVD VIDEO is recorded in multiple audio formats.

◆ When playing a DVD-RW

The type of sound tracks recorded on a disc are displayed. The default setting is underlined.

Example:

- 1: MAIN (main sound)
- 1: SUB (sub sound)
- 1: MAIN+SUB (main and sub sound)

◆ When playing a VIDEO CD, CD, or DATA CD (MP3 audio)

The default setting is underlined.

- STEREO: The standard stereo sound
- 1/L: The sound of the left channel (monaural)
- 2/R: The sound of the right channel (monaural)

◆ When playing a Super VCD

The default setting is underlined.

- 1:STEREO: The stereo sound of the audio track 1
- 1:1/L: The sound of the left channel of the audio track 1 (monaural)
- 1:2/R: The sound of the right channel of the audio track 1 (monaural)
- 2:STEREO: The stereo sound of the audio track 2
- 2:1/L: The sound of the left channel of the audio track 2 (monaural)
- 2:2/R: The sound of the right channel of the audio track 2 (monaural)

Note

While playing a Super VCD on which the audio track 2 is not recorded, no sound will come out when you select “2:STEREO,” “2:1/L,” or “2:2/R.”

Checking the audio signal format **DVD-V**

If you press AUDIO repeatedly during playback, the format of the current audio signal (Dolby Digital, DTS, PCM, etc.) appears as shown below.

Example:

Dolby Digital 5.1 ch

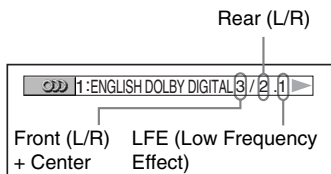

Example:

Dolby Digital 3 ch

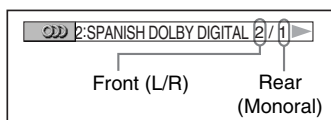

About audio signals

Audio signals recorded in a disc contain the sound elements (channels) shown below. Each channel is output from a separate speaker.

- Front (L)
- Front (R)
- Center
- Rear (L)
- Rear (R)
- Rear (Monaural): This signal can be either the Dolby Surround Sound processed signals or the Dolby Digital sound's monaural rear audio signals.
- LFE (Low Frequency Effect) signal

Note

If "DTS" is set to "OFF" in "AUDIO SETUP" (page 69) the DTS track selection option will not appear on the screen even if the disc contains DTS tracks.

TV Virtual Surround Settings (TVS) **DVD-V**

When you connect a stereo TV or 2 front speakers, TVS (TV Virtual Surround) lets you enjoy surround sound effects by using sound imaging to create virtual rear speakers from the sound of the front speakers (L: left, R: right) without using actual rear speakers. TVS was developed by Sony to produce surround sound for home use using just a stereo TV.

If the player is set up to output the signal from the DIGITAL OUT (COAXIAL) jack, the surround effect will only be heard when "DOLBY DIGITAL" is set to "D-PCM" in "AUDIO SETUP" (page 68).

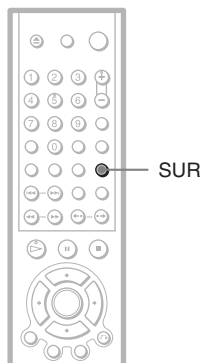

1 Press SUR during playback.

The following display appears.

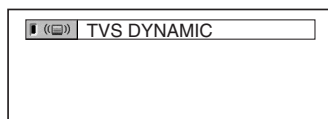

2 Press SUR repeatedly to select one of the TVS sounds.

Refer to the following explanations given for each item.

- TVS DYNAMIC
- TVS WIDE
- TVS NIGHT
- TVS STANDARD

To cancel the setting

Select "OFF" in Step 2.

◆TVS DYNAMIC

Creates virtual rear speakers from the sound of the front speakers (L, R) without using actual rear speakers (shown below).

This mode is effective when the distance between the front L and R speakers is short, such as with built-in speakers on a stereo TV.

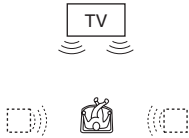

◆TVS WIDE

Creates virtual rear speakers from the sound of the front speakers (L, R) without using actual rear speakers. The virtual speakers are reproduced as shown in the illustration below.

This mode is effective when the distance between the front L and R speakers is short, such as with built-in speakers on a stereo TV.

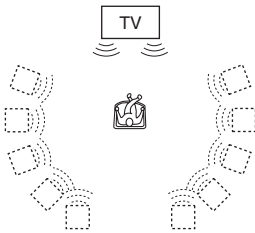

◆TVS NIGHT

Large sounds, such as explosions, are suppressed, but the quieter sounds are unaffected. This feature is useful when you want to hear the dialogue and enjoy the surround sound effects of "TVS WIDE" at low volume.

◆TVS STANDARD

Creates virtual rear speakers from the sound of the front speakers (L, R) without using actual rear speakers. The virtual speakers are reproduced as shown in the illustration below. Use this setting when you want to use surround sound with 2 separate speakers.

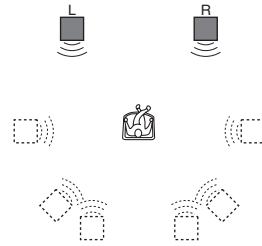

L: Front speaker (left)
R: Front speaker (right)
□: Virtual speaker

Notes

- When the playing signal does not contain a signal for the rear speakers, the surround effects cannot be heard.
- When you select one of the TVS modes, turn off the surround setting of the connected TV or amplifier (receiver).
- Make sure that your listening position is between and at an equal distance from your speakers, and that the speakers are located in similar surroundings.
- Not all discs will respond to the "TVS NIGHT" function in the same way.

Changing the Angles

DVD-V

If various angles (multi-angles) for a scene are recorded on the DVD VIDEO, “” appears in the front panel display. This means that you can change the viewing angle.

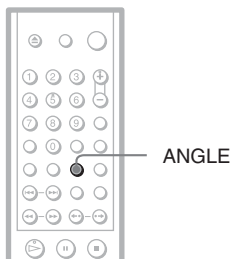

1 Press ANGLE during playback.

The number of the angle appears on the display.

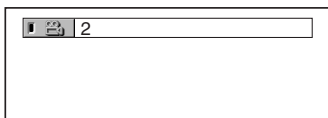

2 Press ANGLE repeatedly to select the angle number.

The scene changes to the selected angle.

Note

Depending on the DVD VIDEO, you may not be able to change the angles even if multi-angles are recorded on the DVD VIDEO.

Displaying the Subtitles

DVD-V DVD-RW

If subtitles are recorded on the discs, you can change the subtitles or turn them on and off whenever you want while playing a DVD.

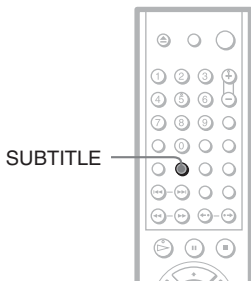

1 Press SUBTITLE during playback.

The following display appears.

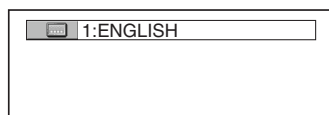

2 Press SUBTITLE repeatedly to select the setting.

◆ When playing a DVD VIDEO

Select the language.

Depending on the DVD VIDEO, the choice of language varies.

When 4 digits are displayed, they indicate a language code. Refer to “Language Code List” on page 77 to see which language the code represents.

◆ When playing a DVD-RW

Select “ON.”

To turn off the subtitles

Select “OFF” in Step 2.

Note

Depending on the DVD VIDEO, you may not be able to change the subtitles even if multilingual subtitles are recorded on it. You also may not be able to turn them off.

Adjusting the Playback Picture (CUSTOM PICTURE MODE)

DVD-V **DVD-RW** **VCD** **DATA CD**

You can adjust the video signal of the DVD, VIDEO CD or DATA CD in JPEG format from the player to obtain the picture quality you want. Choose the setting that best suits the program you are watching.

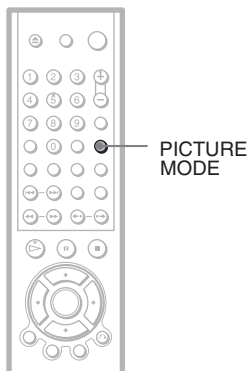

1 Press PICTURE MODE during playback.

The following display appears.

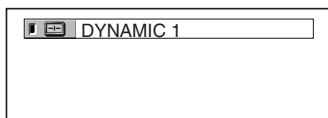

2 Press PICTURE MODE repeatedly to select the setting you want.

The default setting is underlined.

- STANDARD: displays a standard picture.
- DYNAMIC 1: produces a bold dynamic picture by increasing the picture contrast and the color intensity.
- DYNAMIC 2: produces a more dynamic picture than DYNAMIC 1 by further increasing the picture contrast and the color intensity.
- CINEMA 1: enhances details in dark areas by increasing the black level.

- CINEMA 2: White colors become brighter and black colors become richer, and the color contrast is increased.

Hint

When you watch a movie, "CINEMA 1" or "CINEMA 2" is recommended.

Sharpening the Outline of an Image (SHARPNESS)

DVD-V DVD-RW VCD DATA CD

The Sharpness function sharpens the outlines of images on your TV screen.

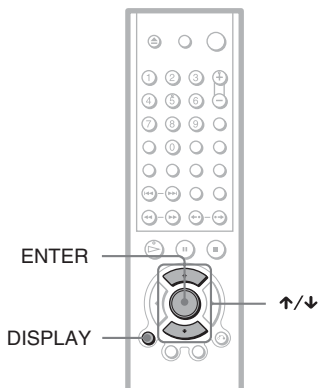

1 Press DISPLAY during playback.

The Control Menu appears.

2 Press \uparrow/\downarrow to select (SHARPNESS), then press ENTER.

The options for “SHARPNESS” appear.

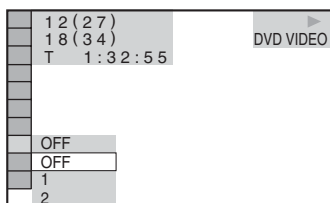

3 Press \uparrow/\downarrow to select a level.

- 1: enhances the outline.
- 2: enhances the outline more than 1.

4 Press ENTER.

The selected setting takes effect.

To cancel the “SHARPNESS” setting

Select “OFF” in Step 3.

Playing a DATA CD

About MP3 Audio Tracks and JPEG Image Files

What is MP3/JPEG?

MP3 is audio compression technology that satisfies the ISO/MPEG regulations. JPEG is image compression technology.

Discs that the player can play

You can play back DATA CDs (CD-ROMs/CD-Rs/CD-RWs) recorded in MP3 (MPEG1 Audio Layer 3) and JPEG format. However, the discs must be recorded according to ISO9660 level 1, level 2 or Joliet format for the player to recognize the tracks (or files). You can also play discs recorded in Multi Session.

See the instructions supplied with the CD-R/CD-RW drives and the recording software (not supplied) for details on the recording format.

Note on the multi-session disc

If MP3 audio tracks or JPEG image files are recorded in the first session, the player will also play MP3 audio tracks or JPEG image files in other sessions. If audio tracks and images in Music CD format or Video CD format are recorded in the first session, only the first session will be played back.

Note

The player may not be able to play some DATA CDs created in the Packet Write format. In this case, you cannot view the JPEG images recorded.

MP3 audio track or JPEG image file that the player can play

The player can play the MP3 audio tracks or JPEG image files:

- which have the extension “.MP3” (MP3 audio track), “.JPG” or “.JPEG” (JPEG image file)
- which conform to the DCF* image file format

* “Design rule for Camera File system”:
Image standards for digital cameras regulated by Japan Electronics and Information Technology Industries Association (JEITA)

Notes

- The player will play any data with the extension “.MP3”, “.JPG” or “.JPEG” even if they are not in MP3 or JPEG format. Playing this data may generate a loud noise which could damage your speaker system.
- The player does not conform to audio in MP3PRO format.

Playback order of MP3 audio tracks or JPEG image files

The playback order of albums, MP3 audio tracks, or JPEG image files recorded on a DATA CD is as follows:

◆Structure of disc contents

Tree 1 Tree 2 Tree 3 Tree 4 Tree 5

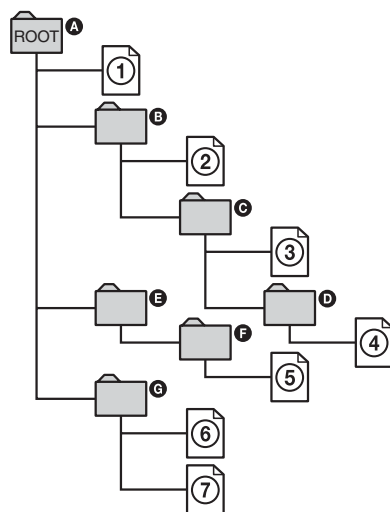

When you insert a DATA CD and press \blacktriangleright , the numbered tracks (or files) are played sequentially, from ① through ⑦. Any sub-albums/tracks (or files) contained within a currently selected album take priority over the next album in the same tree. (Example: **C** contains **D** so ④ is played before ⑤.)

When you press MENU and the list of album names appears (page 52), the album names are arranged in the following order: **A** → **B** → **C** → **D** → **F** → **G**. Albums that do not contain tracks (or files) (such as album **E**) do not appear in the list.

Hints

- If you add numbers (01, 02, 03, etc.) to the front of the track/file names when you store the tracks (or files) in a disc, the tracks and files will be played in that order.
- Since a disc with many trees takes longer to start playback, it is recommended that you create albums with no more than two trees.

Notes

- Depending on the software you use to create the DATA CD, the playback order may differ from the above illustration.
- The playback order above may not be applicable if there are more than 200 albums and 300 files in each album.
- The player can recognize up to 200 albums (the player will count just albums, including albums that do not contain MP3 audio tracks and JPEG image files). The player will not play any albums beyond the first 200 albums.
- The player may take longer time to playback, when progressing to the following album or jump to other album.
- Some types of JPEG file cannot be played.

Playing DATA CDs with MP3 Audio Tracks and JPEG Image Files **DATA CD**

MP3 audio tracks and JPEG image files recorded on DATA CDs (CD-ROMs/CD-Rs/CD-RWs) can be played on this player.

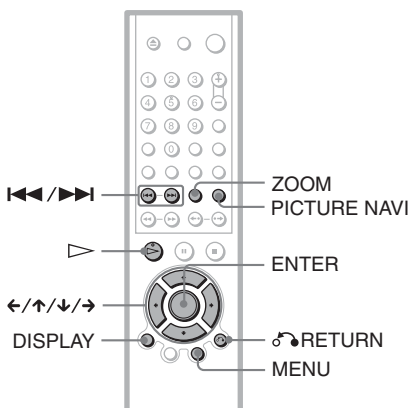

Hints

- You can view the disc information while playing MP3 audio tracks and JPEG image files (page 41).
- You can select Repeat Play (page 35) and audio (page 44) while playing an MP3 audio track.

Note

KODAK Picture CD starts playback automatically when the disc is inserted.

Selecting an album from a DATA CD

- 1 Insert a DATA CD into the disc tray.**

The list of albums recorded on the DATA CD appears.

When an album is being played, its title is shaded. You can turn the album list on and off by pressing the MENU button.

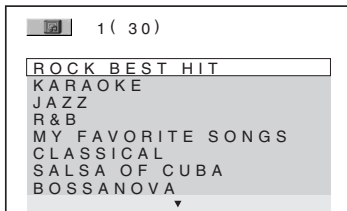

- 2 Press \uparrow/\downarrow to select the album you want and press \triangleright .**

The player starts playing the selected album.

To stop playback

Press \blacksquare .

To play the next or previous MP3 audio track

Press $\blacktriangleright\blacktriangleright$ or $\blacktriangleleft\blacktriangleleft$. Note that you can select the next album by continuing to press $\blacktriangleright\blacktriangleright$ after the last track on the first album, but that you cannot return to the previous album by pressing $\blacktriangleleft\blacktriangleleft$. To return to the previous album, select the album from the album list.

To go to the next or previous JPEG image file

Press \rightarrow or \leftarrow . Note that you can select the next album by continuing to press \rightarrow after the last image on the first album, but that you cannot return to the previous album by pressing \leftarrow . To return to the previous album, select the album from the album list.

To turn off the display

Press MENU.

Selecting an MP3 audio track from a DATA CD

- 1 Insert a DATA CD into the disc tray.**

The albums recorded on the DATA CD appear. When an album is being played, its title is shaded.
- 2 Select an album using \uparrow/\downarrow and press ENTER.**

The list of tracks contained in the album appears.

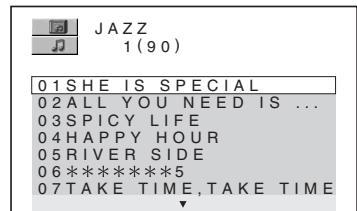

- 3 Select a track using \uparrow/\downarrow and press ENTER.**

The selected track starts playing. You can turn the track list off by pressing the MENU button. Pressing the MENU button again will display the album list.

To stop playback

Press \blacksquare .

To play the next or previous MP3 audio track

Press $\blacktriangleright\blacktriangleright$ or $\blacktriangleleft\blacktriangleleft$. Note that you can select the next album by continuing to press $\blacktriangleright\blacktriangleright$ after the last track on the first album, but that you cannot return to the previous album by pressing $\blacktriangleleft\blacktriangleleft$. To return to the previous album, select the album from the album list.

To return to the previous display

Press ⏪ RETURN.

To turn off the display

Press MENU.

Selecting a JPEG image file from a DATA CD

1 Insert a DATA CD into the disc tray.

The albums recorded on the DATA CD appear. When an album is being played, its title is shaded.

2 Select an album using \uparrow/\downarrow and press PICTURE NAVI.

Images of files in the album appear in 16 subscreens.

1	2	3	4
5	6	7	8
9	10	11	12
13	14	15	16

3 Select the image you want to view by pressing $\leftarrow/\uparrow/\downarrow/\rightarrow$ and press ENTER.

A JPEG image is displayed on the screen.

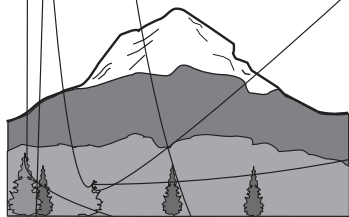

To go to the next or previous JPEG image file

Press \rightarrow or \leftarrow . Note that you can select the next album by continuing to press \rightarrow after the last image on the first album, but that you cannot return to the previous album by pressing \leftarrow .

To return to the previous album, select the album from the album list.

To view the images as a slideshow

Press \triangleright . The slideshow starts from the selected image.

To stop playback

Press \blacksquare .

Hints

- A scroll box is displayed at the right side of the screen.
To display the additional image files, select the bottom image and press \downarrow . To return to the previous image, select the top image and press \uparrow .
- You can also change the slideshow duration (page 56), effect (page 57), and sharpness (page 49) while playing JPEG image files.

Playing Audio Tracks and Images as a Slideshow with Sound

You can play a slideshow with sound by first placing both JPEG and MP3 files in the same album on a DATA CD. Then, when you play back the DATA CD, select AUTO mode as explained below.

1 Insert a DATA CD into the disc tray.

The albums recorded on the DATA CD appear.

2 Press DISPLAY.

The Control Menu appears.

3 Press \downarrow/\uparrow to select MODE(MP3,JPEG), then press ENTER.

The options for "MODE(MP3,JPEG)" appear.

4 Press \downarrow/\uparrow to select the setting you want and press ENTER.

The default setting is underlined.

◆AUTO:

Playback JPEG image files as a slideshow with sound (MP3 audio track).

◆AUDIO(MP3):

Playback MP3 audio tracks continuously.

◆IMAGE(JPEG):

Playback JPEG image files as a slideshow.

5 Press MENU.

The list of albums recorded on the DATA CD appears.

6 Press \downarrow/\uparrow to select the album you want and press \triangleright .

The player starts playing the selected album.

You can turn the album list on and off by pressing the MENU button repeatedly.

Hints

- You can also change the slideshow duration (page 56), effect (page 57) and sharpness (page 49) while viewing JPEG image files.
- If you want to play a slideshow to the same audio track, set the track to Repeat Play (page 35).
- When you select AUTO, the player can recognize up to 300 MP3 tracks and 300 JPEG files in a single album. When you select AUDIO(MP3) or IMAGE(JPEG), the player can recognize up to 600 MP3 tracks and 600 JPEG files in a single album. A maximum of 200 albums can be recognized regardless of the selected mode.

Notes

- You cannot playback JPEG files and MP3 tracks at the same time if they are not contained in the same album.
- When the JPEG image file's playback duration is longer than the MP3 audio track, the image slideshow continues without sound.
- When the MP3 audio track is longer than the JPEG image file's playback duration, the audio track continues with no slideshow.
- If there are no MP3 audio tracks and JPEG image files in the DATA CD, the "No audio data" and "No image data" messages appear on the screen.
- The PICTURE NAVI button does not work when AUDIO(MP3) is selected.
- If you play large MP3 track data and JPEG image data at the same time, the sound may skip. It is recommended that you set the MP3 bit rate to 128kbps or lower when creating the file. If the sound still skips, then reduce the size of the JPEG file.

Rotating a JPEG image

When a JPEG image file is displayed on the screen, you can rotate the image by 90 degrees.

Press \uparrow/\downarrow while viewing an image. Each time you press \uparrow , the image rotates counterclockwise by 90 degrees.

Example of when you press \uparrow once:

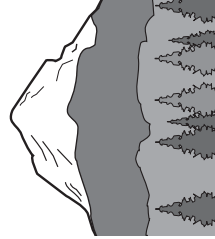

Press CLEAR to return to normal view.

Magnifying a JPEG image

When a JPEG image is displayed on the screen, you can enlarge the image by using the zoom function.

◆ Press ZOOM once

Enlarge the image by twice (x2) the actual size.

◆ Press ZOOM twice

Enlarge the image by twice (x4) the preceding size (x2).

To return to the actual image size at any time

Press CLEAR.

Hint

You can also move the enlarged picture using ←/↑/↓/→.

Notes

- If you press ← or → to go to the next or previous image, the rotating a JPEG image functions are canceled.
- The slideshow stops when you press ↑/↓ or ZOOM buttons
- Nothing happens when you press ← while playing the first image file of the album.

Specifying the slideshow duration **DATA CD**

When you play JPEG image files using slideshow you can specify the duration for which the slides are displayed on the screen.

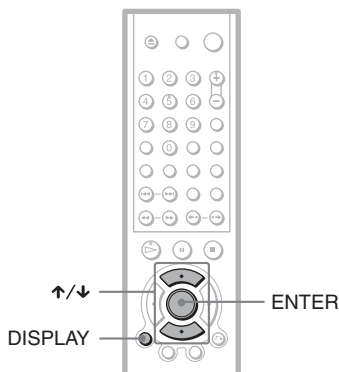

1 Press **DISPLAY** twice.

The Control Menu for JPEG appears.

2 Press **↑/↓** to select (**INTERVAL**), then press **ENTER**.

The options for “INTERVAL” appear.

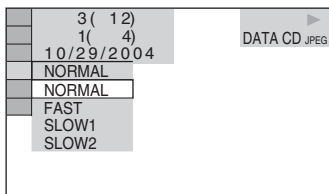

3 Press **↑/↓** to select the setting you want.

The default setting is underlined.

◆ **NORMAL:**

Sets the duration to about 6 seconds.

◆ **FAST:**

Sets the duration to about 3 seconds.

◆ **SLOW1:**

Sets the duration to about 12 seconds.

◆ **SLOW2:**

Sets the duration to about 30 seconds.

4 Press **ENTER**.

The selected setting takes effect.

Note

Some JPEG files may take longer to display than others, which may make the duration seem longer than the one you selected, especially progressive JPEG file.

Selecting an effect for image files in the slideshow **DATA CD**

When you play a JPEG image file, you can select the effect to be used when viewing the slideshow.

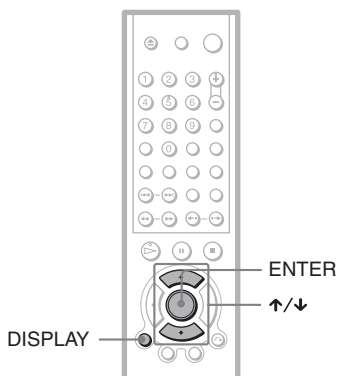

1 Press DISPLAY twice.

The Control Menu for JPEG appears.

2 Press ↑/↓ to select (EFFECT), then press ENTER.

The options for “EFFECT” appear.

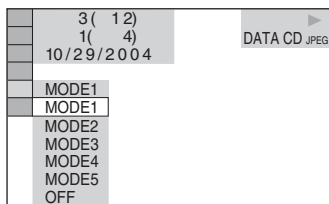

3 Press ↑/↓ to select the setting you want.

The default setting is underlined.

◆ **MODE1:**

The image sweeps in from top to bottom.

◆ **MODE2:**

The image sweeps in from left to right.

◆ **MODE3:**

The image stretches out from the center of the screen.

◆ **MODE4:**

The images randomly cycle through the effects.

◆ **MODE5:**

The next image slides over the previous image.

◆ **OFF:**

Turns off this function. **N-2**

4 Press ENTER.

The selected setting takes effect.

Using Various Additional Functions

Locking Discs (CUSTOM PARENTAL CONTROL, PARENTAL CONTROL)

You can set two kinds of playback restrictions for the desired disc.

- Custom Parental Control

You can set playback restrictions so that the player will not play inappropriate discs.

- Parental Control

Playback of some DVD VIDEOS can be limited according to a predetermined level such as the age of the users. Scenes may be blocked or replaced with different scenes.

The same password is used for both Parental Control and Custom Parental Control.

Custom Parental Control

DVD-V VCD CD

You can set the same Custom Parental Control password for up to 40 discs. When you set the 41st-disc, the first disc is canceled.

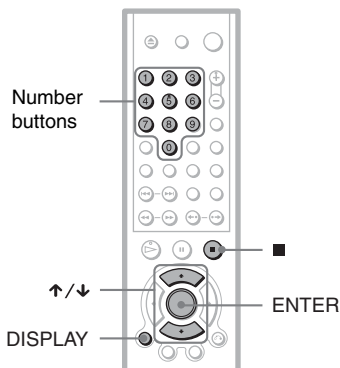

1 Insert the disc you want to lock.

If the disc is playing, press ■ to stop playback.

2 Press DISPLAY while the player is in stop mode.

The Control Menu appears.

3 Press ↑/↓ to select (PARENTAL CONTROL), then press ENTER.

The options for “PARENTAL CONTROL” appear.

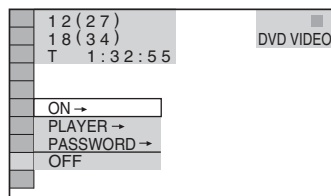

4 Press ↑/↓ to select “ON →,” then press ENTER.

- ◆ If you have not entered a password

The display for registering a new password appears.

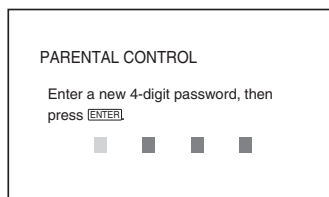

Enter a 4-digit password using the number buttons, then press ENTER.

The display for confirming the password appears.

- ◆ When you have already registered a password

The display for entering the password appears.

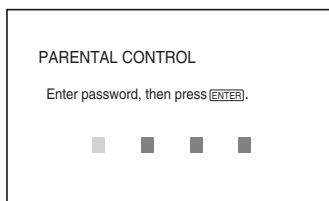

5 Enter or re-enter your 4-digit password using the number buttons, then press ENTER.

“Custom parental control is set.” appears and then the screen returns to the Control Menu.

To turn off the Custom Parental Control function

- 1 Follow Steps 1 through 3 of “Custom Parental Control.”
- 2 Press \uparrow/\downarrow to select “OFF \rightarrow ,” then press ENTER.
- 3 Enter your 4-digit password using the number buttons, then press ENTER.

To play a disc for which Custom Parental Control is set

- 1 Insert the disc for which Custom Parental Control is set.
The “CUSTOM PARENTAL CONTROL” display appears.

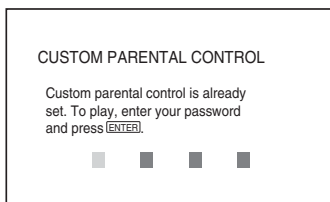

- 2 Enter your 4-digit password using the number buttons, then press ENTER.
The player is ready for playback.

Hint

If you forget your password, enter the 6-digit number “199703” using the number buttons when the “CUSTOM PARENTAL CONTROL” display asks you for your password, then press ENTER. The display will ask you to enter a new 4-digit password.

Parental Control (limited playback) **DVD-V**

Playback of some DVD VIDEOS can be limited according to a predetermined level such as the age of the users. The “PARENTAL CONTROL” function allows you to set a playback limitation level.

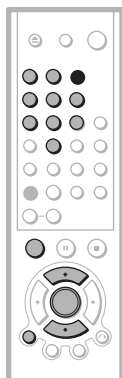

- 1 Press DISPLAY while the player is in stop mode.
The Control Menu appears.
- 2 Press \uparrow/\downarrow to select (PARENTAL CONTROL), then press ENTER.
The options for “PARENTAL CONTROL” appear.

- 3 Press \uparrow/\downarrow to select “PLAYER \rightarrow ,” then press ENTER.
◆ If you have not entered a password
The display for registering a new password appears.

Enter a 4-digit password using the number buttons, then press ENTER. The display for confirming the password appears.

◆ **When you have already registered a password**

The display for entering the password appears.

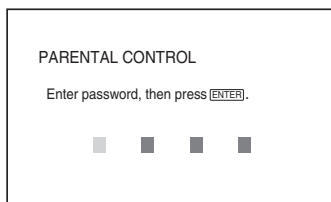

4 Enter or re-enter your 4-digit password using the number buttons, then press ENTER.

The display for setting the playback limitation level appears.

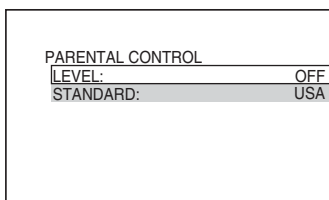

5 Press ↑/↓ to select “STANDARD,” then press ENTER.

The selection items for “STANDARD” are displayed.

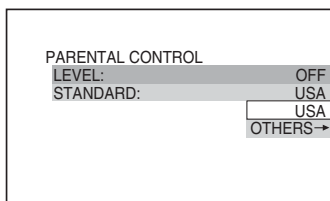

6 Press ↑/↓ to select a geographic area as the playback limitation level, then press ENTER.

The area is selected.
When you select “OTHERS →,” select and enter a standard code in the table on page 61 using the number buttons.

7 Press ↑/↓ to select “LEVEL,” then press ENTER.

The selection items for “LEVEL” are displayed.

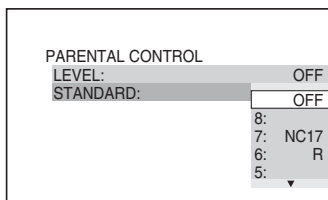

8 Select the level you want using ↑/↓, then press ENTER.

Parental Control setting is complete.

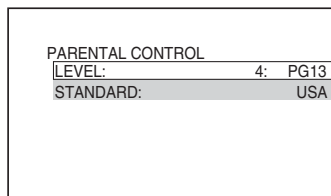

The lower the value, the stricter the limitation.

To turn off the Parental Control function

Set “LEVEL” to “OFF” in Step 8.

To play a disc for which Parental Control is set

- 1 Insert the disc and press ▷ .
The display for entering your password appears.
- 2 Enter your 4-digit password using the number buttons, then press ENTER.
The player starts playback.

💡 Hint

If you forget your password, remove the disc and repeat Steps 1 to 3 of “Parental Control (limited playback).” When you are asked to enter your password, enter “199703” using the number buttons, then press ENTER. The display will ask you to enter a new 4-digit password. After you enter a new 4-digit password, replace the disc in the player and press ▷ . When the display for entering your password appears, enter your new password.

Notes

- The Control Menu display will show different items depending on the disc type.
- When you play discs which do not have the Parental Control function, playback cannot be limited on this player.
- Depending on the disc, you may be asked to change the parental control level while playing the disc. In this case, enter your password, then change the level. If the Resume Play mode is canceled, the level returns to the previous level.

Area Code

Standard	Code number
Argentina	2044
Australia	2047
Austria	2046
Belgium	2057
Brazil	2070
Canada	2079
Chile	2090
China	2092
Denmark	2115
Finland	2165
France	2174
Germany	2109
India	2248
Indonesia	2238
Italy	2254
Japan	2276
Korea	2304
Malaysia	2363
Mexico	2362
Netherlands	2376
New Zealand	2390
Norway	2379
Pakistan	2427
Philippines	2424
Portugal	2436
Russia	2489
Singapore	2501
Spain	2149
Sweden	2499
Switzerland	2086
Thailand	2528
United Kingdom	2184

Changing the password

- 1 Press DISPLAY while the player is in stop mode.**
The Control Menu appears.
- 2 Press \uparrow/\downarrow to select  (PARENTAL CONTROL), then press ENTER.**
The options for “PARENTAL CONTROL” appear.
- 3 Press \uparrow/\downarrow to select “PASSWORD \rightarrow ,” then press ENTER.**
The display for entering the password appears.
- 4 Enter your 4-digit password using the number buttons, then press ENTER.**
- 5 Enter a new 4-digit password using the number buttons, then press ENTER.**
- 6 To confirm your password, re-enter it using the number buttons, then press ENTER.**

If you make a mistake entering your password

Press \leftarrow before you press ENTER and input the correct number.

Controlling Your TV with the Supplied Remote

You can control the sound level, input source, and power switch of your Sony TV with the supplied remote.

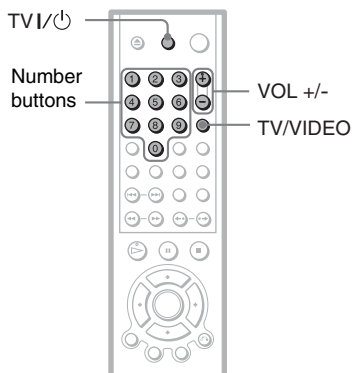

You can control your TV using the buttons below.

By pressing	You can
TV I/⏻	Turn the TV on or off
VOL +/-	Adjust the volume of the TV
TV/VIDEO	Switch the TV's input source between the TV and other input sources.

Note

Depending on the unit being connected, you may not be able to control your TV using all or some of the buttons on the supplied remote.

Controlling other TVs with the remote

You can control the sound level, input source, and power switch of non-Sony TVs as well. If your TV is listed in the table below, set the appropriate manufacturer's code.

1 While holding down TV I/⏻, press the number buttons to select your TV's manufacturer's code (see the table below).

2 Release TV I/⏻.

Code numbers of controllable TVs

If more than one code number is listed, try entering them one at a time until you find the one that works with your TV.

Manufacturer	Code number
Sony	01 (default)
Daewoo	04, 22
Hitachi	02, 04
JVC	09
LG/Goldstar	04
MGA/Mitsubishi	04, 13
Panasonic	19
Philips	21
RCA	04, 10
Samsung	04, 20
Sharp	18
Toshiba	07, 18

Notes

- If you enter a new code number, the code number previously entered will be erased.
- When you replace the remote's batteries, the code number you have set may be reset to the default setting. Set the appropriate code number again.
- Depending on the unit being connected, you may not be able to control your TV using all or some of the buttons on the supplied remote.

Using the Setup Display

By using the Setup Display, you can make various adjustments to items such as picture and sound. You can also set a language for the subtitles and the Setup Display, among other things. For details on each Setup Display item, see pages from 64 to 68.

Note

Playback settings stored in the disc take priority over the Setup Display settings and not all of the functions described may work.

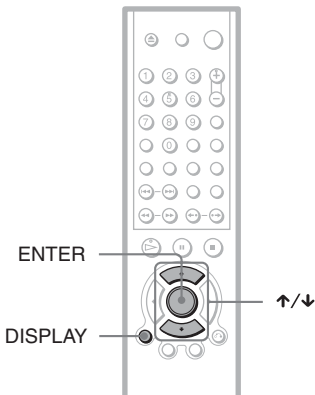

1 Press DISPLAY when the player is in stop mode.

The Control Menu appears.

2 Press ↑/↓ to select (SETUP), then press ENTER.

The options for "SETUP" appear.

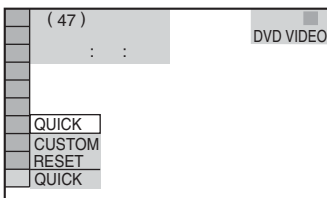

3 Press ↑/↓ to select "CUSTOM," then press ENTER.

The Setup Display appears.

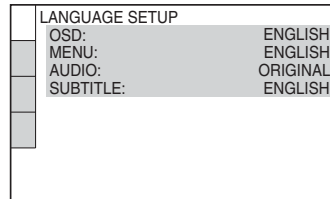

4 Press ↑/↓ to select the setup item from the displayed list:

"LANGUAGE SETUP," "SCREEN SETUP," "CUSTOM SETUP," or "AUDIO SETUP." Then press ENTER.

The Setup item is selected.

Example: "SCREEN SETUP"

Selected item

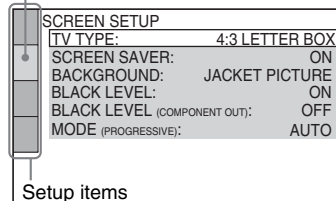

Setup items

5 Select an item using ↑/↓, then press ENTER.

The options for the selected item appear.

Example: "TV TYPE"

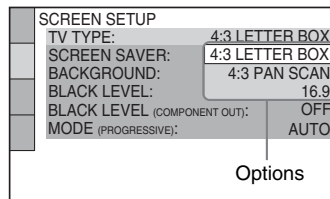

Options

6 Select a setting using \uparrow/\downarrow , then press ENTER.

The setting is selected and setup is complete.

Example: "16:9"

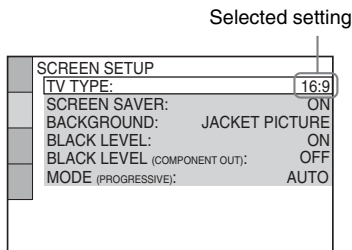

To enter the Quick Setup mode

Select "QUICK" in Step 3. Follow from Step 5 of the Quick Setup explanation to make basic adjustments (page 25).

To reset all of the "SETUP" settings

- 1 Select "RESET" in Step 3 and press ENTER.
- 2 Select "YES" using \uparrow/\downarrow .
You can also quit the process and return to the Control Menu by selecting "NO" here.
- 3 Press ENTER.
All of the settings explained on pages 64 to 69 return to the default settings. Do not press \mathbb{L}/\mathbb{C} while resetting the player as it takes a few seconds to complete.

Setting the Display or Sound Track Language

(LANGUAGE SETUP)

"LANGUAGE SETUP" allows you to set various languages for the on-screen display or sound track.

Select "LANGUAGE SETUP" in the Setup Display. To use the display, see "Using the Setup Display" (page 63).

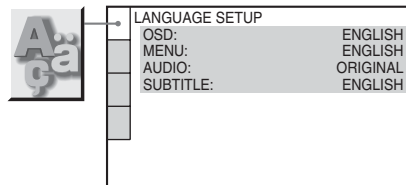

◆ OSD (On-Screen Display)

Switches the display language on the screen.

◆ MENU (DVD VIDEO only)

You can select the desired language for the disc's menu.

◆ AUDIO (DVD VIDEO only)

Switches the language of the sound track. When you select "ORIGINAL," the language given priority in the disc is selected.

◆ SUBTITLE (DVD VIDEO only)

Switches the language of the subtitle recorded on the DVD VIDEO.

When you select "AUDIO FOLLOW," the language for the subtitles changes according to the language you selected for the sound track.

🔧 Hint

If you select "OTHERS \rightarrow " in "MENU," "SUBTITLE," and "AUDIO," select and enter a language code from "Language Code List" on page 77 using the number buttons.

Note

When you select a language in "MENU," "SUBTITLE," or "AUDIO" that is not recorded on the DVD VIDEO, one of the recorded languages will be automatically selected.

◆ BLACK LEVEL (COMPONENT OUT)

Selects the black level (setup level) for the video signals output from the COMPONENT VIDEO OUT jacks. When progressive signals are being output (PROGRESSIVE is lit on the front panel display), BLACK LEVEL (COMPONENT OUT) is set to off regardless of the setting (ON/OFF).

OFF Sets the black level of the output signal to the standard level.

ON

Note

Using the LINE OUT (VIDEO) jack or the S VIDEO OUT jack will cause the picture to become unclear or go blank when you set NORMAL/PROGRESSIVE switch to PROGRESSIVE. In this case, set NORMAL/PROGRESSIVE switch to NORMAL so that the PROGRESSIVE indicator turns off.

When NORMAL/PROGRESSIVE switch is set to PROGRESSIVE

You can fine-tune the Progressive (480p) video signal output when you set NORMAL/PROGRESSIVE switch to PROGRESSIVE (the PROGRESSIVE indicator lights up) and connect the player using the COMPONENT VIDEO OUT jacks to a TV that is able to accept the video signal in progressive format.

◆ MODE(PROGRESSIVE)

DVD software can be divided into two types: film based software and video based software. Video based software is derived from TV, such as dramas and sit-coms, and displays images at 30 frames/60 fields per second. Film based software is derived from film and displays images at 24 frames per second. Some DVD software contains both Video and Film.

In order for these images to appear natural on your screen when output in PROGRESSIVE mode (60 frames per second), the progressive video signal needs to be converted to match the type of DVD software that you are watching.

Custom Settings (CUSTOM SETUP)

Use this to set up playback related and other settings.

Select "CUSTOM SETUP" in the Setup Display. To use the display, see "Using the Setup Display" (page 63).

The default settings are underlined.



CUSTOM SETUP	
AUTO POWER OFF:	OFF
AUTO PLAY:	OFF
DIMMER:	BRIGHT
PAUSE MODE:	AUTO
TRACK SELECTION:	OFF
MULTI-DISC RESUME:	ON

◆ AUTO POWER OFF

Switches the Auto Power Off setting on or off.

<u>OFF</u>	Switches this function off.
ON	The player enters standby mode when left in stop mode for more than 30 minutes.

◆ AUTO PLAY

Switches the Auto Play setting on or off. This function is useful when the player is connected to a timer (not supplied).

<u>OFF</u>	Switches this function off.
ON	Automatically starts playback when the player is turned on by a timer (not supplied).

◆ DIMMER

Adjusts the lighting of the front panel display.

<u>BRIGHT</u>	Makes the lighting bright.
DARK	Makes the lighting dark.

◆ PAUSE MODE (DVD VIDEO/DVD-RW only)

Selects the picture in pause mode.

<u>AUTO</u>	The picture, including subjects that move dynamically, is output with no jitter. Normally select this position.
FRAME	The picture, including subjects that do not move dynamically, is output in high resolution.

◆ TRACK SELECTION (DVD VIDEO only)

Gives the sound track which contains the highest number of channels priority when you play a DVD VIDEO on which multiple audio formats (PCM, DTS, or Dolby Digital format) are recorded.

<u>OFF</u>	No priority given.
AUTO	Priority given.

Notes

- When you set the item to "AUTO," the language may change. The "TRACK SELECTION" setting has higher priority than the "AUDIO" settings in "LANGUAGE SETUP" (page 64).
- If you set "DTS" to "OFF" (page 69), the DTS sound track is not played even if you set "TRACK SELECTION" to "AUTO."
- If PCM, DTS, and Dolby Digital sound tracks have the same number of channels, the player selects PCM, DTS, and Dolby Digital sound tracks in this order.

◆ MULTI-DISC RESUME (DVD VIDEO/VIDEO CD only)

Switches the Multi-disc Resume setting on or off. Resume playback point can be stored in memory for up to 6 different DVD VIDEO/VIDEO CD discs (page 29).

<u>ON</u>	Stores the resume settings in memory for up to six discs.
OFF	Does not store the resume settings in memory. Playback restarts at the resume point only for the current disc in the player.

Settings for the Sound

(AUDIO SETUP)

“AUDIO SETUP” allows you to set the sound according to the playback and connection conditions.

Select “AUDIO SETUP” in the Setup Display. To use the display, see “Using the Setup Display” (page 63).
The default settings are underlined.

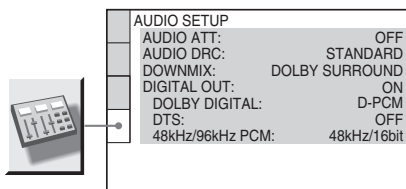

◆ AUDIO ATT (attenuation)

If the playback sound is distorted, set this item to “ON.” The player reduces the audio output level.

This function affects the output of the LINE OUT L/R (AUDIO) jacks.

<u>OFF</u>	Normally, select this position.
ON	Select this when the playback sound from the speakers is distorted.

◆ AUDIO DRC (Dynamic Range Control) (DVD VIDEO/DVD-RW only)

Makes the sound clear when the volume is turned down when playing a DVD that conforms to “AUDIO DRC.” This affects the output from the following jacks:

- LINE OUT L/R (AUDIO) jacks
- DIGITAL OUT (COAXIAL) jack only when “DOLBY DIGITAL” is set to “D-PCM” (page 69).

<u>STANDARD</u>	Normally select this position.
TV MODE	Makes the low sounds clear even if you turn the volume down.
WIDE RANGE	Gives you the feeling of being at a live performance.

◆ DOWNMIX (DVD VIDEO/DVD-RW only)

Switches the method for mixing down to 2 channels when you play a DVD which has rear sound elements (channels) or is recorded in Dolby Digital format. For details on the rear signal components, see “Checking the audio signal format” (page 45). This function affects the output of the following jacks:

- LINE OUT L/R (AUDIO) jacks
- DIGITAL OUT (COAXIAL) jack when “DOLBY DIGITAL” is set to “D-PCM” (page 69).

<u>DOLBY SURROUND</u>	Normally, select this position. Multi-channel audio signals are output to two channels for enjoying surround sounds
NORMAL	Multi-channel audio signals are downmixed to two channels for use with your stereo.

◆ DIGITAL OUT

Selects if audio signals are output via the DIGITAL OUT (COAXIAL) jack.

<u>ON</u>	Normally select this position. When you select “ON,” see “Setting the digital output signal” for further settings.
OFF	The influence of the digital circuit upon the analog circuit is minimal.

Setting the digital output signal

Switches the method of outputting audio signals when you connect a component such as an amplifier (receiver) or MD deck with a digital input jack.

For connection details, see page 20. Select “DOLBY DIGITAL,” “DTS,” and “48kHz/96kHz PCM” after setting “DIGITAL OUT” to “ON.”

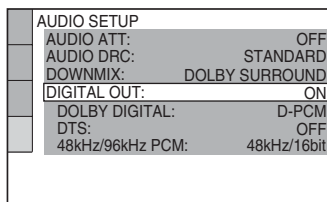

If you connect a component that does not conform to the selected audio signal, a loud noise (or no sound) will come out from the speakers, damaging your ears or speakers.

◆ DOLBY DIGITAL (DVD VIDEO/DVD-RW only)

Selects the type of Dolby Digital signal.

D-PCM	Select this when the player is connected to an audio component without a built-in Dolby Digital decoder. You can select whether the signals conform to Dolby Surround (Pro Logic) or not by making adjustments to the “DOWNMIX” item in “AUDIO SETUP” (page 68).
DOLBY DIGITAL	Select this when the player is connected to an audio component with a built-in Dolby Digital decoder.

◆ DTS

Selects whether or not to output DTS signals.

OFF	Select this when the player is connected to an audio component without a built-in DTS decoder.
ON	Select this when the player is connected to an audio component with a built-in DTS decoder.

◆ 48kHz/96kHz PCM (DVD VIDEO only)

Selects the sampling frequency of the audio signal.

48kHz/16bit	The audio signals of DVD VIDEOS are always converted to 48kHz/16bit.
96kHz/24bit	All types of signals including 96kHz/24bit are output in their original format. However, if the signal is encrypted for copyright protection purposes, the signal is only output as 48kHz/16bit.

Note

The analog audio signals from the LINE OUT L/R (AUDIO) jacks are not affected by this setting and keep their original sampling frequency level.

Additional Information

Troubleshooting

If you experience any of the following difficulties while using the player, use this troubleshooting guide to help remedy the problem before requesting repairs. Should any problem persist, consult your nearest Sony dealer (for customers in the USA only).

Power

The power is not turned on.

- ➔ Check that the AC power cord is connected securely.

Picture

There is no picture/picture noise appears.

- ➔ Re-connect the connecting cord securely.
- ➔ The connecting cords are damaged.
- ➔ Check the connection to your TV (page 18) and switch the input selector on your TV so that the signal from the player appears on the TV screen.
- ➔ The disc is dirty or flawed.
- ➔ If the picture output from your player goes through your VCR to get to your TV or if you are connected to a combination TV/VIDEO player, the copy-protection signal applied to some DVD programs could affect picture quality. If you still experience problems even when you connect your player directly to your TV, please try connecting your player to your TV's S VIDEO input (page 18).
- ➔ You set the NORMAL/PROGRESSIVE switch to PROGRESSIVE on the rear panel (the PROGRESSIVE indicator lights up) even though your TV cannot accept the progressive signal. In this case, set the NORMAL/PROGRESSIVE switch to NORMAL on the rear panel so that the PROGRESSIVE indicator turns off.
- ➔ You set the NORMAL/PROGRESSIVE switch to PROGRESSIVE on the rear panel (the PROGRESSIVE indicator lights up) but did not connect your TV to the player's COMPONENT VIDEO OUT jacks using a COMPONENT VIDEO cord. Set to the PROGRESSIVE only when you connect

your TV to the player's COMPONENT VIDEO OUT jacks using a component video cord (page 18).

- ➔ Even if your TV is compatible with progressive format (480p) signals, the image may be affected when you set the player to progressive format. In this case, set the NORMAL/PROGRESSIVE switch to NORMAL so that the PROGRESSIVE indicator turns off and the player is set to normal (interlace) format.

Even though you set the aspect ratio in "TV TYPE" of "SCREEN SETUP," the picture does not fill the screen.

- ➔ The aspect ratio of the disc is fixed on your DVD.

Sound

There is no sound.

- ➔ Re-connect the connecting cord securely.
- ➔ The connecting cord is damaged.
- ➔ The player is connected to the wrong input jack on the amplifier (receiver) (page 22, 23, 24).
- ➔ The amplifier (receiver) input is not correctly set.
- ➔ The player is in pause mode or in Slow-motion Play mode.
- ➔ The player is in fast forward or fast reverse mode.
- ➔ If the audio signal does not come through the DIGITAL OUT (COAXIAL) jack, check the audio settings (page 68).
- ➔ While playing a Super VCD on which the audio track 2 is not recorded, no sound will come out when you select "2:STEREO," "2:1/L," or "2:2/R."

Sound distortion occurs.

- ➔ Set "AUDIO ATT" in "AUDIO SETUP" to "ON" (page 68).

The sound volume is low.

- ➔ The sound volume is low on some DVDs. The sound volume may improve if you set "AUDIO DRC" to "TV MODE" (page 68).
- ➔ Set "AUDIO ATT" in "AUDIO SETUP" to "OFF" (page 68).

Operation

The remote does not function.

- ➔ There are obstacles between the remote and the player.
- ➔ The distance between the remote and the player is too far.
- ➔ The remote is not pointed at the remote sensor on the player.
- ➔ The batteries in the remote are weak.

The disc does not play.

- ➔ The disc is turned over.
Insert the disc with the playback side facing down on the disc tray.
- ➔ The disc is skewed.
- ➔ The player cannot play certain discs (page 8).
- ➔ The region code on the DVD does not match the player.
- ➔ Moisture has condensed inside the player (page 5).
- ➔ The player cannot play a recorded disc that is not correctly finalized (page 9).

The MP3 audio track cannot be played (page 50).

- ➔ The DATA CD is not recorded in an MP3 format that conforms to ISO9660 Level 1/ Level 2 or Joliet.
- ➔ The MP3 audio track does not have the extension “.MP3.”
- ➔ The data is not formatted in MP3 even though it has the extension “.MP3.”
- ➔ The data is not MPEG1 Audio Layer 3 data.
- ➔ The player cannot play audio tracks in MP3PRO format.
- ➔ The MODE(MP3,JPEG) setting has been set to IMAGE (JPEG) (page 53).

The JPEG image file cannot be played (page 50)

- ➔ The DATA CD is not recorded in a JPEG format that conforms to ISO9660 Level 1, or Joliet.
- ➔ It has an extension other than “.JPG” or “.JPEG”.
- ➔ It is larger than 3072 (width) x 2048 (height) in Normal mode or more than 3,300,000 dots in Progressive JPEG.
- ➔ It does not fit the screen (those images are reduced).
- ➔ The MODE(MP3,JPEG) setting has been set to AUDIO (MP3) (page 53).

The MP3 audio tracks and JPEG image files start playing simultaneously.

- ➔ AUTO has been selected in MODE(MP3,JPEG) (page 53).

The title of the albums, MP3 tracks, or JPEG files are not displayed correctly.

- ➔ The player can only display numbers and letters of the alphabet. Other characters are displayed as “*.”

The disc does not start playing from the beginning.

- ➔ Program Play, Shuffle Play, Repeat Play, or A-B Repeat Play has been selected (page 32).
- ➔ Resume play has taken effect (page 29).

The player starts playing the disc automatically.

- ➔ The disc features an auto playback function.
- ➔ “AUTO PLAY” in “CUSTOM SETUP” is set to “ON” (page 67).

Playback stops automatically.

- ➔ While playing discs with an auto pause signal, the player stops playback at the auto pause signal.

You cannot perform some functions such as Stop, Search, Slow-motion Play, Repeat Play, Shuffle Play, or Program Play.

- ➔ Depending on the disc, you may not be able to do some of the operations above. See the operating manual that comes with the disc.

The language for the sound track cannot be changed.

- ➔ Try using the DVD's menu instead of the direct selection button on the remote (page 30).
- ➔ Multilingual tracks are not recorded on the DVD being played.
- ➔ The DVD prohibits the changing of the language for the sound track.

The subtitle language cannot be changed or turned off.

- ➔ Try using the DVD's menu instead of the direct selection button on the remote (page 30).
- ➔ Multilingual subtitles are not recorded on the DVD being played.
- ➔ The DVD prohibits the changing of subtitles.

The angles cannot be changed.

- ➔ Try using the DVD's menu instead of the direct selection button on the remote (page 30).
- ➔ Multi-angles are not recorded on the DVD being played.
- ➔ The angle can only be changed when the "⏏" indicator lights up on the front panel display (page 11).
- ➔ The DVD prohibits changing of the angles.

The player does not operate properly.

- ➔ When static electricity, etc., causes the player to operate abnormally, unplug the player.

5 numbers or letters are displayed on the screen and on the front panel display.

- ➔ The self-diagnosis function was activated. (See the table on page 73.)

The disc tray does not open and "LOCKED" appears on the front panel display.

- ➔ Child Lock is set (page 28).

The disc tray does not open and "TRAY LOCKED" appears on the front panel display.

- ➔ Contact your Sony dealer or local authorized Sony service facility.

"Data error" appears on the TV screen when playing a DATA CD.

- ➔ The MP3 audio track/JPEG image file you want to play is broken.
 - ➔ The data is not MPEG1 Audio Layer 3 data.
 - ➔ The JPEG image file format does not conform to DCF (page 50).
 - ➔ The JPEG image file has the extension ".JPG" or ".JPEG" but not in JPEG format.
-

Self-diagnosis Function

(When letters/numbers appear in the display)

When the self-diagnosis function is activated to prevent the player from malfunctioning, a five-character service number (e.g., C 13 50) with a combination of a letter and four digits appears on the screen and the front panel display. In this case, check the following table.

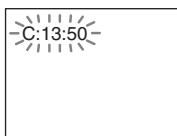

First three characters of the service number	Cause and/or corrective action
C 13	The disc is dirty. ➔ Clean the disc with a soft cloth (page 9).
C 31	The disc is not inserted correctly. ➔ Re-insert the disc correctly.
E XX (xx is a number)	To prevent a malfunction, the player has performed the self-diagnosis function. ➔ Contact your nearest Sony dealer or local authorized Sony service facility and give the 5-character service number. Example: E 61 10

Glossary

Album (page 50, 51)

A unit in which to store JPEG image files or MP3 audio tracks on a DATA CD. ("Album" is an exclusive definition for this player.)

Chapter (page 11)

Sections of a picture or a music feature that are smaller than titles. A title is composed of several chapters. Depending on the disc, no chapters may be recorded.

Dolby Digital (page 24, 69)

Digital audio compression technology developed by Dolby Laboratories. This technology conforms to multi-channel surround sound. The rear channel is stereo and there is a discrete subwoofer channel in this format. Dolby Digital provides the same discrete channels of high quality digital audio found in "Dolby Digital" theater surround sound systems. Good channel separation is realized because all of the channel data are recorded discretely and little deterioration is realized because all channel data processing is digital.

Dolby Surround (Pro Logic) (page 23)

Audio signal processing technology that Dolby Laboratories developed for surround sound. When the input signal contains a surround component, the Pro Logic process outputs the front, center and rear signals. The rear channel is monaural.

DTS (page 24, 69)

Digital audio compression technology that Digital Theater Systems, Inc. developed. This technology conforms to multi-channel surround sound. The rear channel is stereo and there is a discrete subwoofer channel in this format. DTS provides the same discrete channels of high quality digital audio. Good channel separation is realized because all of the channel data is recorded discretely and little deterioration is realized because all channel data processing is digital.

DVD VIDEO (page 8)

A disc that contains up to 8 hours of moving pictures even though its diameter is the same as a CD.

The data capacity of a single-layer and single-sided DVD is 4.7 GB (Giga Byte), which is 7 times that of a CD. The data capacity of a double-layer and single-sided DVD is 8.5 GB, a single-layer and double-sided DVD is 9.4 GB, and double-layer and double-sided DVD is 17GB.

The picture data uses the MPEG 2 format, one of the worldwide standards of digital compression technology. The picture data is compressed to about 1/40 (average) of its original size. The DVD also uses a variable rate coding technology that changes the data to be allocated according to the status of the picture. Audio information is recorded in a multi-channel format, such as Dolby Digital, allowing you to enjoy a more real audio presence.

Furthermore, various advanced functions such as the multi-angle, multilingual, and Parental Control functions are provided with the DVD.

DVD-RW (page 8)

A DVD-RW is a recordable and rewritable disc that is the same size as a DVD VIDEO. The DVD-RW has two different modes: VR mode and Video mode. DVD-RWs created in Video mode have the same format as a DVD VIDEO, while discs created in VR (Video Recording) mode allow the contents to be programmed or edited.

DVD+RW (page 8)

A DVD+RW (plus RW) is a recordable and rewritable disc. DVD+RWs use a recording format that is comparable to the DVD VIDEO format.

File (page 50, 53)

A JPEG image recorded on a DATA CD ("File" is an exclusive definition for this player.) A single file consist of a single image.

Film based software, Video based software (page 66)

DVDs can be classified as Film based or Video based software. Film based DVDs contain the same images (24 frames per second) that are shown at movie theaters. Video based DVDs, such as television dramas or sit-coms, displays images at 30 frames (or 60 fields) per second.

Index (CD)/Video Index (VIDEO CD) (page 14)

A number that divides a track into sections to easily locate the point you want on a CD or VIDEO CD. Depending on the disc, no index may be recorded.

Normal (Interlace) format (page 66)

Normal (Interlace) format shows every other line of an image as a single "field" and is the standard method for displaying images on television. The even number field shows the even numbered lines of an image, and the odd numbered field shows the odd numbered lines of an image.

Progressive format (page 66)

Compared to the Normal (Interlace) format that alternately shows every other line of an image (field) to create one frame, the Progressive format shows the entire image at once as a single frame. This means that while the Normal (Interlace) format can show 30 frames/60 fields in one second, the Progressive format can show 60 frames in one second. The overall picture quality increases and still images, text, and horizontal lines appear sharper. This player is compatible with the 480 progressive format.

Progressive JPEG (page 56)

Progressive JPEGs are used mostly on the internet. They are different from other JPEGs in that they "fade in" gradually instead of being drawn from top to bottom when displayed on a browser. This lets you view the image while it is being downloaded.

Scene (page 11)

On a VIDEO CD with PBC (playback control) functions, the menu screens, moving pictures and still pictures are divided into sections called "scenes."

Title (page 11)

The longest section of a picture or music feature on a DVD, movie, etc., in video software, or the entire album in audio software.

Track (page 11)

Sections of a picture or a music feature on a VIDEO CD, CD or DATA CD. (the length of a song). (“Track” in DATA CD is an exclusive definition for this player.)

Specifications

System

Laser: Semiconductor laser

Signal format system: NTSC

Audio characteristics

Frequency response: DVD VIDEO (PCM 96 kHz): 2 Hz to 44 kHz (± 1.0 dB)/DVD VIDEO (PCM 48 kHz): 2 Hz to 22 kHz (± 0.5 dB)/CD: 2 Hz to 20 kHz (± 0.5 dB)

Signal-to-noise ratio (S/N ratio): 115 dB

Harmonic distortion: 0.003 %

Dynamic range: DVD VIDEO: 103 dB/CD: 99 dB

Wow and flutter: Less than detected value ($\pm 0.001\%$ W PEAK)

Outputs

(Jack name): Jack type/Output level/Load impedance)

LINE OUT (AUDIO): Phono jack/2 Vrms/10 kilohms

DIGITAL OUT (COAXIAL): Phono jack/0.5 V_{p-p}/75 ohms

COMPONENT VIDEO OUT(Y, P_B, P_R):
Phono jack/Y: 1.0 V_{p-p}/P_B, P_R:
0.65 V_{p-p}/75 ohms

LINE OUT (VIDEO): Phono jack/1.0 V_{p-p}/75 ohms

S VIDEO OUT: 4-pin mini DIN/Y:
1.0 V_{p-p}, C: 0.286 V_{p-p}/75 ohms

General

Power requirements:

120 V AC, 60 Hz

110 – 240 V AC, 50/60 Hz

See page 5 for further information.

Power consumption:

 11 W

Dimensions (approx.):

430 × 43 × 237.7 mm (17 × 2 ¹¹/₁₆ × 9 ¹/₃ in.)
(width/height/depth) incl. projecting parts

Mass (approx.): 1.95 kg (4 ¹/₃ lb)

Operating temperature: 5 °C to 35 °C
(41 °F to 95 °F)

Operating humidity: 25 % to 80 %

Supplied accessories

See page 17.

Specifications and design are subject to change without notice.

ENERGY STAR® is a U.S. registered mark. As an ENERGY STAR® Partner, Sony Corporation has determined that this product meets the ENERGY STAR® guidelines for energy efficiency.

Language Code List

For details, see pages 44, 47, 64.

The language spellings conform to the ISO 639: 1988 (E/F) standard.

Code Language	Code Language	Code Language	Code Language
1027 Afar	1183 Irish	1347 Maori	1507 Samoan
1028 Abkhazian	1186 Scots Gaelic	1349 Macedonian	1508 Shona
1032 Afrikaans	1194 Galician	1350 Malayalam	1509 Somali
1039 Amharic	1196 Guarani	1352 Mongolian	1511 Albanian
1044 Arabic	1203 Gujarati	1353 Moldavian	1512 Serbian
1045 Assamese	1209 Hausa	1356 Marathi	1513 Siswati
1051 Aymara	1217 Hindi	1357 Malay	1514 Sesotho
1052 Azerbaijani	1226 Croatian	1358 Maltese	1515 Sundanese
1053 Bashkir	1229 Hungarian	1363 Burmese	1516 Swedish
1057 Byelorussian	1233 Armenian	1365 Nauru	1517 Swahili
1059 Bulgarian	1235 Interlingua	1369 Nepali	1521 Tamil
1060 Bihari	1239 Interlingue	1376 Dutch	1525 Telugu
1061 Bislama	1245 Inupiak	1379 Norwegian	1527 Tajik
1066 Bengali;	1248 Indonesian	1393 Occitan	1528 Thai
Bangla	1253 Icelandic	1403 (Afan)Oromo	1529 Tigrinya
1067 Tibetan	1254 Italian	1408 Oriya	1531 Turkmen
1070 Breton	1257 Hebrew	1417 Punjabi	1532 Tagalog
1079 Catalan	1261 Japanese	1428 Polish	1534 Setswana
1093 Corsican	1269 Yiddish	1435 Pashto;	1535 Tonga
1097 Czech	1283 Javanese	Pushto	1538 Turkish
1103 Welsh	1287 Georgian	1436 Portuguese	1539 Tsonga
1105 Danish	1297 Kazakh	1463 Quechua	1540 Tatar
1109 German	1298 Greenlandic	1481 Rhaeto-	1543 Twi
1130 Bhutani	1299 Cambodian	Romance	1557 Ukrainian
1142 Greek	1300 Kannada	1482 Kirundi	1564 Urdu
1144 English	1301 Korean	1483 Romanian	1572 Uzbek
1145 Esperanto	1305 Kashmiri	1489 Russian	1581 Vietnamese
1149 Spanish	1307 Kurdish	1491 Kinyarwanda	1587 Volapük
1150 Estonian	1311 Kirghiz	1495 Sanskrit	1613 Wolof
1151 Basque	1313 Latin	1498 Sindhi	1632 Xhosa
1157 Persian	1326 Lingala	1501 Sangho	1665 Yoruba
1165 Finnish	1327 Laothian	1502 Serbo-	1684 Chinese
1166 Fiji	1332 Lithuanian	Croatian	1697 Zulu
1171 Faroese	1334 Latvian;	1503 Singhalese	
1174 French	Lettish	1505 Slovak	
1181 Frisian	1345 Malagasy	1506 Slovenian	1703 Not specified

Index

Numerics

- 16:9 65
- 4:3 LETTER BOX 65
- 4:3 PAN SCAN 65
- 48kHz/96kHz PCM 69
- 5.1 Channel Surround 45

A

- A-B REPEAT 36
- ALBUM 38
- Album 50, 73
- ANGLE 47
- AUDIO 44, 64
- AUDIO ATT 68
- AUDIO DRC 68
- AUDIO SETUP 68
- AUTO PLAY 67
- AUTO POWER OFF 67

B

- BACKGROUND 65
- Batteries 17
- BLACK LEVEL 65
- BLACK LEVEL
(COMPONENT OUT) 66

C

- CD 8, 27
- CHAPTER 38
- Chapter 11, 73
- CHAPTER VIEWER 40
- Child Lock 28
- Connecting 18
- Continuous play
 - CD/VIDEO CD 27
 - DVD 27
- Control Menu 14
- CUSTOM 63
- CUSTOM PARENTAL
CONTROL 58
- CUSTOM PICTURE MODE
48
- CUSTOM SETUP 67

D

- DATA CD 8, 50
- DIGITAL OUT 68
- Digital output 68
- DIMMER 67
- Display
 - Control Menu display 14
 - Front panel display 11
 - Setup Display 63
- DOLBY DIGITAL 24, 44,
69, 73
- DOWNMIX 68
- DTS 24, 44, 69, 73
- DVD 8, 27, 74
- DVD+RW 8, 28, 74
- DVD's menu 30
- DVD-RW 8, 30, 74

E

- EFFECT 57

F

- Fast forward 37
- Fast reverse 37
- FILE 38
- File 74
- Film based software 66, 74
- AYSetup



Printed on 100% recycled paper using VOC (Volatile Organic Compound)-free vegetable oil based ink.

<http://www.sony.net/>

Sony Corporation Printed in China