



OWNER'S MANUAL

DC-1100A Dust Collector



JET
WMH Tool Group
www.wmhtoolgroup.com

P.O. BOX 1349
Auburn, WA 98071-1349
e-mail jet@wmhtoolgroup.com

Phone:253-351-6000
Fax: 1-800-274-6840
M-708639 05/02

This manual has been prepared for the owner and operators of a JET DC-1100A. Its purpose, aside from machine operation, is to promote safety through the use of accepted correct operating and maintenance procedures. Completely read the safety and maintenance instructions before operating or servicing the machine. To obtain maximum life and efficiency from your dust collector, and to aid in using the machine safely, read this manual thoroughly and follow instructions carefully.

Warranty & Service

The WMH Tool Group warrants every product it sells. If one of our tools needs service or repair, one of our Authorized Repair Stations located throughout the United States can give you quick service.

In most cases, any one of these WMH Tool Group Repair Stations can authorize warranty repair, assist you in obtaining parts, or perform routine maintenance and major repair on your JET, Performax, Wilton, or Powermatic tools.

For the name of an Authorized Repair Station in your area, please call 1-800-274-6848, or visit www.wmhtoolgroup.com

More Information

Remember, the WMH Tool Group is consistently adding new products to the line. For complete, up-to-date product information, check with your local WMH Tool Group distributor, or visit www.wmhtoolgroup.com

WMH Tool Group Warranty

The WMH Tool Group (including Performax, Wilton and Powermatic brands) makes every effort to assure that its products meet high quality and durability standards and warrants to the original retail consumer/purchaser of our products that each product be free from defects in materials and workmanship as follow: 1 YEAR LIMITED WARRANTY ON ALL PRODUCTS UNLESS SPECIFIED OTHERWISE. This Warranty does not apply to defects due directly or indirectly to misuse, abuse, negligence or accidents, normal wear-and-tear, repair or alterations outside our facilities, or to a lack of maintenance.

THE WMH TOOL GROUP LIMITS ALL IMPLIED WARRANTIES TO THE PERIOD SPECIFIED ABOVE, FROM THE DATE THE PRODUCT WAS PURCHASED AT RETAIL. EXCEPT AS STATED HEREIN, ANY IMPLIED WARRANTIES OR MERCHANTABILITY AND FITNESS ARE EXCLUDED. SOME STATES DO NOT ALLOW LIMITATIONS ON HOW LONG THE IMPLIED WARRANTY LASTS, SO THE ABOVE LIMITATION MAY NOT APPLY TO YOU. THE WMH TOOL GROUP SHALL IN NO EVENT BE LIABLE FOR DEATH, INJURIES TO PERSONS OR PROPERTY, OR FOR INCIDENTAL, CONTINGENT, SPECIAL, OR CONSEQUENTIAL DAMAGES ARISING FROM THE USE OF OUR PRODUCTS. SOME STATES DO NOT ALLOW THE EXCLUSION OR LIMITATION OF INCIDENTAL OR CONSEQUENTIAL DAMAGES, SO THE ABOVE LIMITATION OR EXCLUSION MAY NOT APPLY TO YOU.

To take advantage of this warranty, the product or part must be returned for examination, postage prepaid, to an Authorized Repair Station designated by our office. Proof of purchase date and an explanation of the complaint must accompany the merchandise. If our inspection discloses a defect, we will either repair or replace the product, or refund the purchase price if we cannot readily and quickly provide a repair or replacement, if you are willing to accept a refund. We will return repaired product or replacement at JET'S expense, but if it is determined there is no defect, or that the defect resulted from causes not within the scope of JET'S warranty, then the user must bear the cost of storing and returning the product. This warranty gives you specific legal rights; you may also have other rights which vary from state to state.

The WMH Tool Group sells through distributors only. Members of the WMH Tool Group reserve the right to effect at any time, without prior notice, those alterations to parts, fittings, and accessory equipment which they may deem necessary for any reason whatsoever.

WARNING

1. **Read and understand the entire contents of this manual before attempting assembly or operation. Do not use this machine until proper training and knowledge has been obtained.**
2. Do not leave Dust Collector when plugged in. Unplug from outlet when not in use and before servicing.
3. Do not use outdoors or on wet surfaces.
4. Do not allow to be used as a toy. Close attention is necessary when used near children.
5. Use only as described in this manual. Use only manufacturer's recommended attachments.
6. Do not use with damaged cord or plug. If Dust Collector is not working as it should, has been dropped, damaged, left outdoor, or dropped in water, return it to a service center.
7. Do not pull or carry by cord, use cord as a handle, close a door on cord, or pull cord around sharp edges or corners. Do not run Dust Collector over cord. Keep cord away from heated surfaces.
8. Do not unplug by pulling on cord. To unplug, grasp the plug, not the cord.
9. Do not handle plug or Dust Collector with wet hands.
10. Do not put any objects into the openings. Do not use with any opening blocked; keep free of dust, lint, hair, and anything that may reduce air flow.
11. Keep hair, loose clothing, fingers, and all parts of body away from opening and moving parts.
12. Do not pick up anything that is burning or smoking, such as cigarettes, matches, or hot ashes.
13. Do not use without dust bag and/or filters in place.
14. Turn off all controls before unplugging.
15. Do not use to pick up flammable or combustible liquids such as gasoline or use in areas where they may be present.
16. Do not operate without hose connected to the inlet ports or covered by an inlet cap. Hazardous moving parts inside. Unplug machine before removing inlet port, inlet cap, hose, or inlet guard.
17. Use the inlet caps to cover the inlet port openings that are not connected to hoses.
18. Some dust created by power sanding, sawing, grinding, drilling and other construction activities contains chemicals known to cause cancer, birth defects or other reproductive harm. Some examples of these chemicals are:
 - Lead from lead based paint
 - Crystalline silica from bricks and cement and other masonry products, and
 - Arsenic and chromium from chemically-treated lumber.
19. Your risk from those exposures varies, depending on how often you do this type of work. To reduce your exposure to these chemicals: work in a well ventilated area, and work with approved safety equipment, such as those dust masks that are specifically designed to filter out microscopic particles
20. Do not operate tool while under the influence of drugs, alcohol or any medication.
21. Make sure the extension cord is in good condition. When using an extension cord, be sure to use one heavy enough to carry the current your product will draw. An undersize cord will cause a drop in the line voltage resulting in loss of power and overheating. The table below shows the correct size to use depending on cord length and nameplate ampere rating. If in doubt, use the next heavier gauge. The smaller gauge number, the heavier the cord.
22. Do not use dust collector for anything except wood dust. Materials such as liquids, metal shavings, metal dust, screws, glass, plastic or rock can cause sparks and/or damage when coming into contact with any part of the dust collector.
23. Ground your dust collector along all plastic componets. The connection of bare 12 gauge copper wire on all plastic hoses, fittings and blast gates to all machines will help reduce the occurrence of static build up and discharge.

SAVE THESE INSTRUCTIONS

Grounding Instructions

Caution: This tool must be grounded while in use to protect the operator from electric shock.

In the event of a malfunction or breakdown, grounding provides a path of least resistance for electric current to reduce the risk of electric shock. This tool is equipped with an electric cord having an equipment-grounding conductor and a grounding plug. The plug must be plugged into a matching outlet that is properly installed and grounded in accordance with all local codes and ordinances.

Do not modify the plug provided. If it will not fit the outlet, have the proper outlet installed by a qualified electrician.

Improper connection of the equipment-grounding conductor can result in a risk of electric shock. The conductor, with insulation having an outer surface that is green with or without yellow stripes, is the equipment-grounding conductor. If repair or replacement of the electric cord or plug is necessary, do not connect the equipment-grounding conductor to a live terminal.

Check with a qualified electrician or service personnel if the grounding instructions are not completely understood, or if in doubt as to whether the tool is properly grounded. Use only three wire extension cords that have three-prong grounding plugs and three-pole receptacles that accept the tool's plug.

Repair or replace a damaged or worn cord immediately.

115 Volt Operation

As received from the factory, your dust collector is ready to run at 115 volt operation. This dust collector, when wired for 115 volts, is intended for use on a circuit that has an outlet and a plug that looks the one illustrated in Figure A. A temporary adapter, which looks like the adapter as illustrated in Figure B, may be used to connect this plug to a two-pole receptacle, as shown in Figure B if a properly grounded outlet is not available. The temporary adapter should only be used until a properly grounded outlet can be installed by a qualified electrician. **This adapter is not applicable in Canada.** The green colored rigid ear, lug, or tab, extending from the adapter, must be connected to a permanent ground such as a properly grounded outlet box, as shown in Figure B.

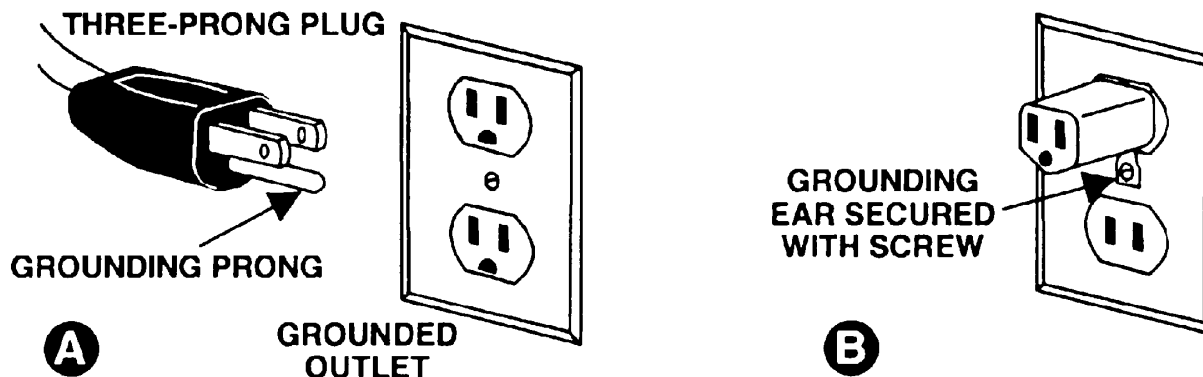

230 Volt Operation

If 230V, single phase operation is desired, the following instructions must be followed:

1. Disconnect the machine from the power source.
2. This dust collector is supplied with four motor leads that are connected for 115V operation, as shown in Figure A. Reconnect these four motor leads for 230V operation, as shown in Figure B.
3. The 115V attachment plug supplied with the dust collector must be replaced with a UL/CSA listed plug suitable for 230V operation. Contact your local Authorized JET Service Center or qualified electrician for proper procedures to install the plug. The dust collector must comply with all local and national codes after the 230V plug is installed.
4. The dust collector with a 230V plug should only be connected to an outlet having the same configuration. No adapter is available or should be used with the 230V plug.

Important: In all cases (115 or 230 volts), make certain the receptacle in question is properly grounded. If you are not sure, have a registered electrician check the receptacle.

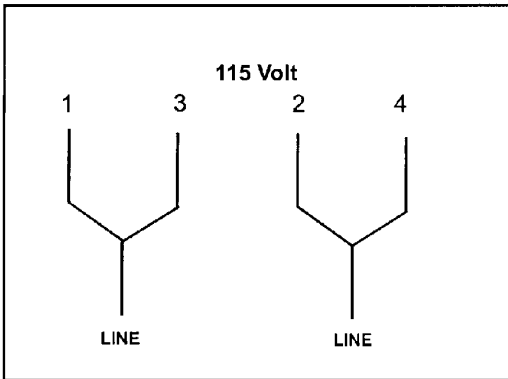

FIGURE A

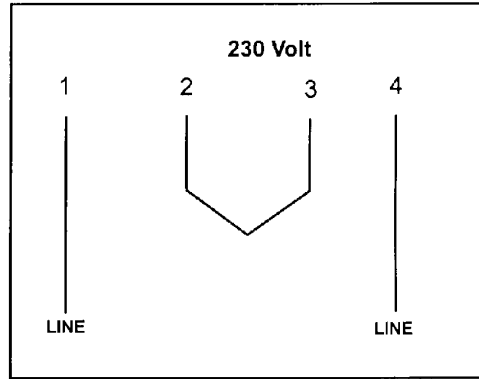
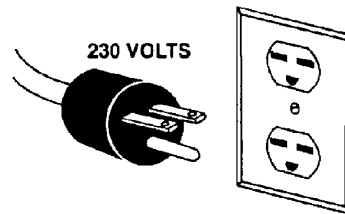
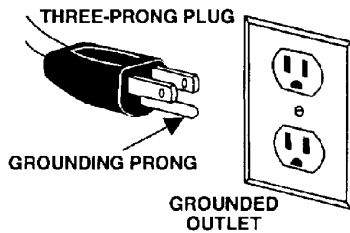

FIGURE B



On-Off Switch Padlock

Model No. PB-1, Stock No. 709012

To safeguard your machine from unauthorized operation and to avoid accidental starting by young children, the use of a padlock is highly recommended. JET model PB-1 is available from your local authorized JET distributor or by calling JET Equipment & Tools at 800-274-6848.

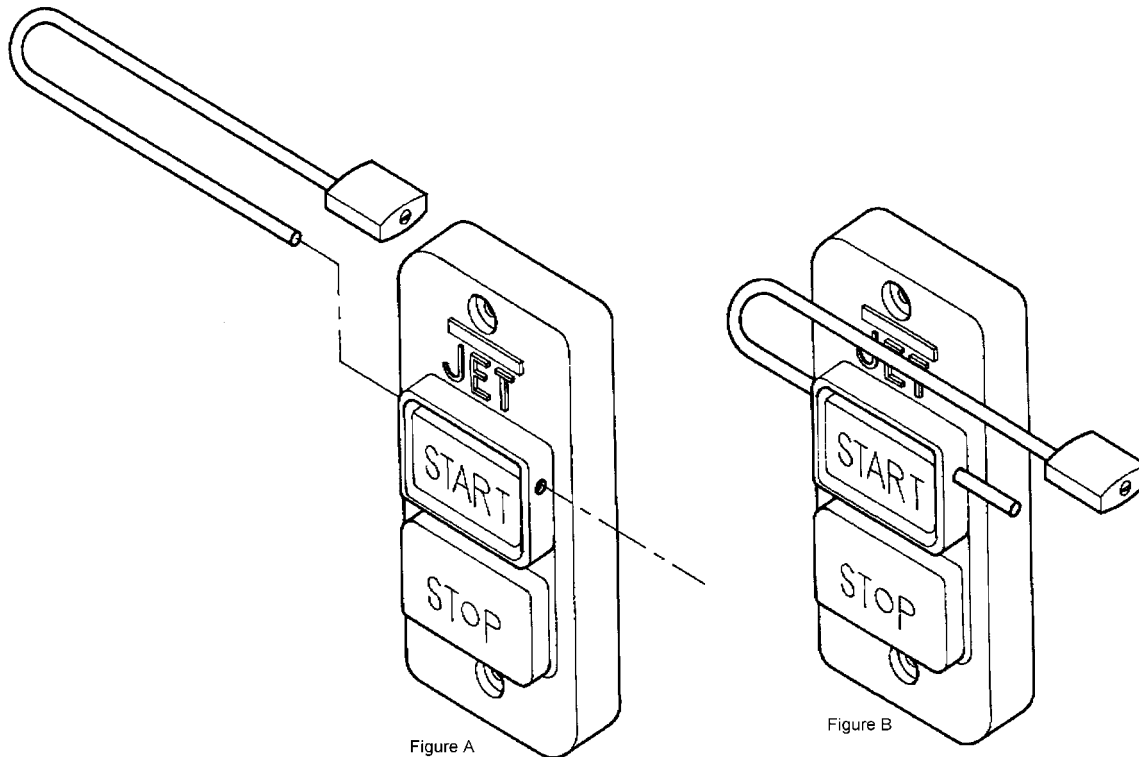

To lock out an on-off switch:

1. Open the padlock. See Fig. A.
2. Insert through holes in the start button. See Fig. B
3. Close the padlock.
4. Place the key in a safe place.

Specifications:

DC-1100A

Stock Number.....	708639
Blower Wheel Diameter.....	11"
Sound Rating at 3 feet.....	70-80 db
Hose Diameter.....	4" & 6"
Air Flow (CFM).....	1,100
Velocity at 4" (FPM).....	13,745
Static Pressure (inch of water).....	11.50
Bag Diameter.....	20"
Bag Length.....	46" & 29"
Collector Bag Capacity (cu. ft.).....	5.6
Overall Dimensions.....	37"L x 28"W x 96"H
Motor (TEFC).....	1-1/2 HP, 1Ph 115/230V, Prewired 115V
Net Weight (approx.).....	108 lbs.

Table of Contents

Page

Warranty.....	2
Warnings.....	3
Grounding Instructions.....	4
115V Operation.....	4
230V Operation.....	5
Padlock.....	6
Specifications.....	7
Table of Contents.....	7
Unpacking DC-1100.....	8
Contents of Shipping Carton.....	8
Tools Required for Assembly.....	8
Assembly.....	9-11
Electrical Connections.....	11
Turning the Machine On & Off.....	11
Maintenance.....	12
Cleaning the Filter Bag.....	12
Removing the Collector Bag.....	12
Motor.....	12
Connecting the Dust collector to a Machine.....	12
Grounding the Dust Collection System.....	12
Parts Breakdown and Parts List.....	13-14
Wiring Diagrams.....	15

The specifications in this manual are given as general information and are not binding. JET Equipment & Tools reserves the right to effect, at any time and without prior notice, changes or alterations to parts, fittings, and accessory equipment deemed necessary for any reason whatsoever.

⚠ WARNING

**Read and understand the entire contents of this manual before attempting assembly or operation of the dust collector!
Failure to comply may cause serious injury!**

Unpacking

1. Finish removing all contents from the shipping carton.
2. Report any damage to your distributor.
3. Do not discard any shipping material until after the dust collector has been assembled and is running properly.

Contents of the Shipping Carton

- 1 Bag Hanger
- 1 Base
- 1 Housing
- 1 Hanger Bracket
- 1 Hose
- 1 Owner's Manual
- 1 Warranty Card
- 1 Motor/Fan Assembly
- 1 Collector Bag
- 1 Filter Bag
- 2 Hose Clamps
- 1 Retainer Strap
- 4 Casters
- 1 Inlet Cover & Hose Inlet
- 3 Support Legs
- 1 Bag of Assembly Hardware
 - 16. M8 x 16 Hex Cap Bolts
 - 22. M8 Flat Washers
 - 8. M6 x 12 Pan Head Flange Bolts
 - 6. M8 Hex Nuts

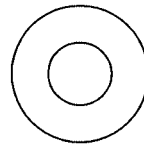

22) M8
Flat Washers

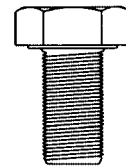

16) M8 x 16
Hex Cap Bolts

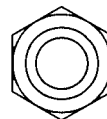

6) M8
Hex Nuts

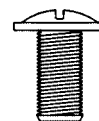

8) M6 x 12
Pan Head Flange Bolts

Tools Required for Assembly

2. 1/2" or 13mm Wrenches or sockets
1. 9/16" or 14mm Wrench or socket
1. #2 Cross Point Screw Driver

Assembly

1. Install four casters to the under side of the base as pictured in Fig. 1. Thread the hex nut (B, Fig. 1) onto the caster shaft. Then slide the lock washer (A, Fig. 1) over the caster shaft. Thread the caster shaft into the threaded hole on the underside of the base, turn until snug. Tighten the nut (B, Fig. 1) against the base with a 9/16" or 14mm wrench. This will give the caster proper clearance.

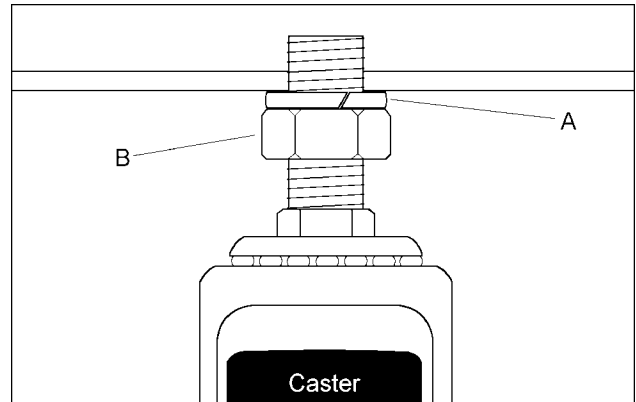

Fig. 1

2. Place the base with casters on the ground. Attach the motor and fan assembly (A, Fig. 2) to the base using four M8 x 16 hex cap bolts, four M8 flat washers (B, Fig. 2), and a 1/2" or 13mm wrench.

⚠ WARNING
The dust collector must be disconnected from the power source during assembly. Failure to comply may result in serious injury!

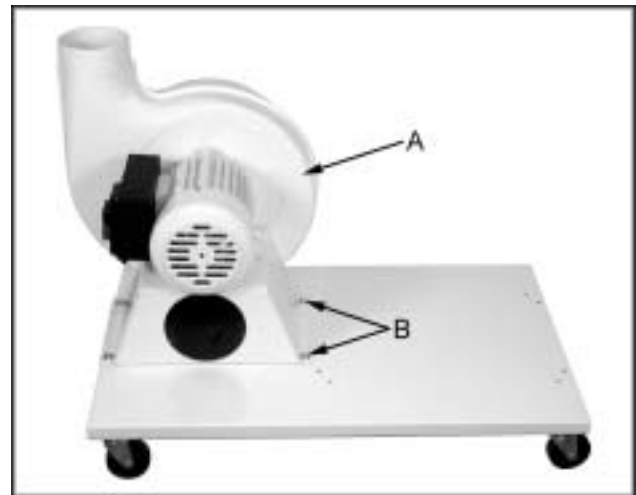

Fig. 2

3. Attach inlet guard (A, Fig. 3) to fan housing using eight M5 x 12 pan head screws (B, Fig. 3). Press the inlet ports onto the inlet guard until it snaps into place.

⚠ WARNING
To reduce the risk of injury from moving parts, always keep inlet ports covered with the caps provided, if they are not connected to a flexible hose. Failure to comply may result in serious injury!

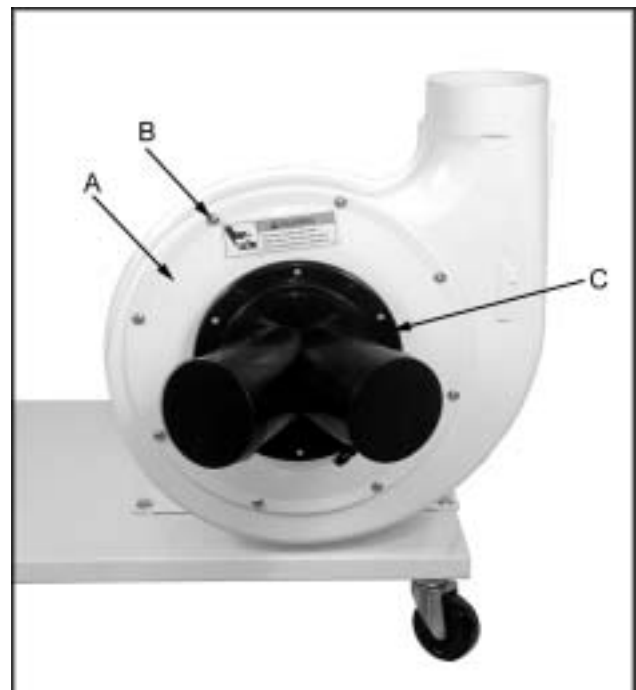

Fig. 3

4. Attach three support brackets (A, Fig. 4) to the base using six M8 x 16 hex cap bolts and six M8 flat washers (B, Fig. 4). Hand tighten only at this time.

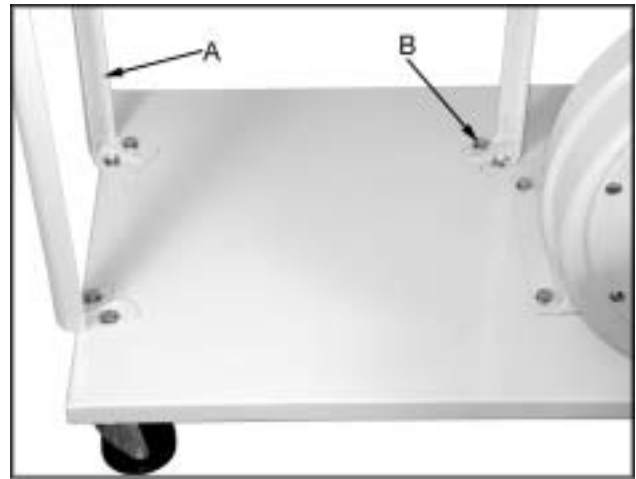

Fig. 4

5. Install the housing (A, Fig. 5) to two support brackets using four M8 x 16 hex cap bolts, eight M8 flat washers, and four M8 hex nuts (B, Fig.5). Be sure hose opening faces fan housing. Before attaching third support bracket place the hanger bracket (C, Fig.5) between the support bracket and the housing. Tighten all nuts and bolts at this time with a 1/2" or 13mm wrench.



Fig. 5

6. Attach the hose (A, Fig. 6) between the fan housing and the collector housing with two clamps (B, Fig. 6). Tighten the clamps to secure the hose.



Fig. 6

7. Slide the bag hanger hook (A, Fig. 7) through the top loop of the filter bag. Insert the hanger into the hanger bracket. Thread the retainer strap (B, Fig. 7) through the loops on the filter bag (C, Fig.7), and fasten to the collector housing. The retainer strap should be tight enough to provide a good seal.
8. Insert the ring (A, Fig. 8) of the collector bag into the bottom of the housing at an angle. Pull down on the bag to make sure it "seats" in the housing.

Electrical Connections

	<p>WARNING</p> <p>All electrical connections must be done by a qualified electrician. All adjustments or repairs must be done with the dust collector disconnected from the power source, unplugged. Failure to comply may result in serious injury!</p>
---	---

The DC-1100A dust collector is rated at **115/230V, Prewired 115V**. Use a plug and outlet rated at least 20 amps. The circuit for the machine should also be protected by at least a 20 amp circuit breaker or fuse. Keep in mind that a curcuit being used by other machines, tools, lights, heaters, etc. at the same time will add to the electrical load. A dedicated curcuit to the dust collector will give you the best results since dust collectors are generally used at the same time other tools are running.

Before hooking up to the power source, make sure that the switch is in the off position.

Turning the Machine On & Off

Before hooking up to the power source, make sure that the switch is in the off position. The dust collector can be turned on by pressing the start button found on the motor. Press the stop button to turn off the dust collector.



Fig. 7

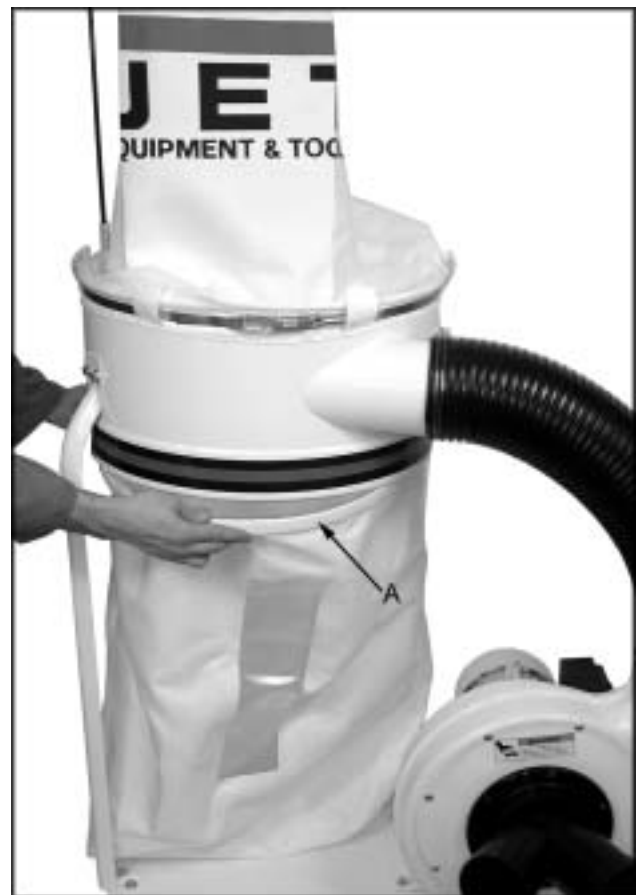

Fig. 8

Maintenance

WARNING

Never perform maintenance on this machine before turning switch off and removing plug from power source, unplug. Failure to comply may cause serious injury!

Cleaning the Filter Bag

CAUTION

Wearing a particle mask/respirator for protection against fine dust particles during cleaning is highly recommended.

During first use and after cleaning, the filter bag may allow some dust to escape. This is normal and will stop after a short period of time.

Clean both the filter and collector bags frequently to keep the collector's performance at its optimum. To clean:

1. **Disconnect the machine from the power source.**
2. Unhook the filter bag from the hanger and shake the bag so that the majority of the dust falls into the collector bag.
3. Loosen the retaining strap, and remove the filter bag from the housing.
4. Turn the bag inside out and clean.
5. Turn the bag outside in and re-attach to the housing using the retainer strap to secure.

Removing the Collector Bag

1. **Disconnect the machine from the power source, unplug.**
2. Remove the collector bag by pushing the ring of the collector bag upwards and pulling the bag out at an angle.
3. Empty the contents into an appropriate container.
4. Turn the bag inside out and clean.

5. Turn the bag outside in and insert into the housing.

Use the proper type hose to connect the dust collector to the machine being operated. Dryer vent hose is not acceptable for this purpose. Contact your nearest JET distributor for the full line of JET Dust Collector Hoses and Accessories. Customize your installation and obtain maximum performance with JET's dust hoods, hoses, clamps, fittings, and blast gates. Accessories.

Motor

Make frequent inspections of the motor fan and blow out (with low pressure air hose) or vacuum any accumulation of foreign material in order to maintain normal motor ventilation.

Connecting the Dust collector to a Machine

Use the proper type hose to connect the dust collector to the machine being operated. Dryer vent hose is not acceptable for this purpose. Contact your nearest JET distributor for the full line of JET Dust Collector Hoses and Accessories. Customize your installation and obtain maximum performance with JET's dust hoods, hoses, clamps, fittings, and blast gates.

You can also purchase the JET *"Dust Collection Basics Video"* stock # JW1050V through your JET Distributor

Grounding the Dust Collection System

The dust collection system includes the dust collector and the hose, or duct work you use to connect the tools. The dust collector is grounded though the ground wire in the cord. The hose or duct work you use to connect the tool to the dust collector must also be grounded. To assist in grounding your system you can purchase the JET *"Dust Collector Grounding Kit"* stock # JW1053, and also the JET *"Dust Collection Basics Video"* stock # JW1050V through JET Distributors.

Parts Breakdown

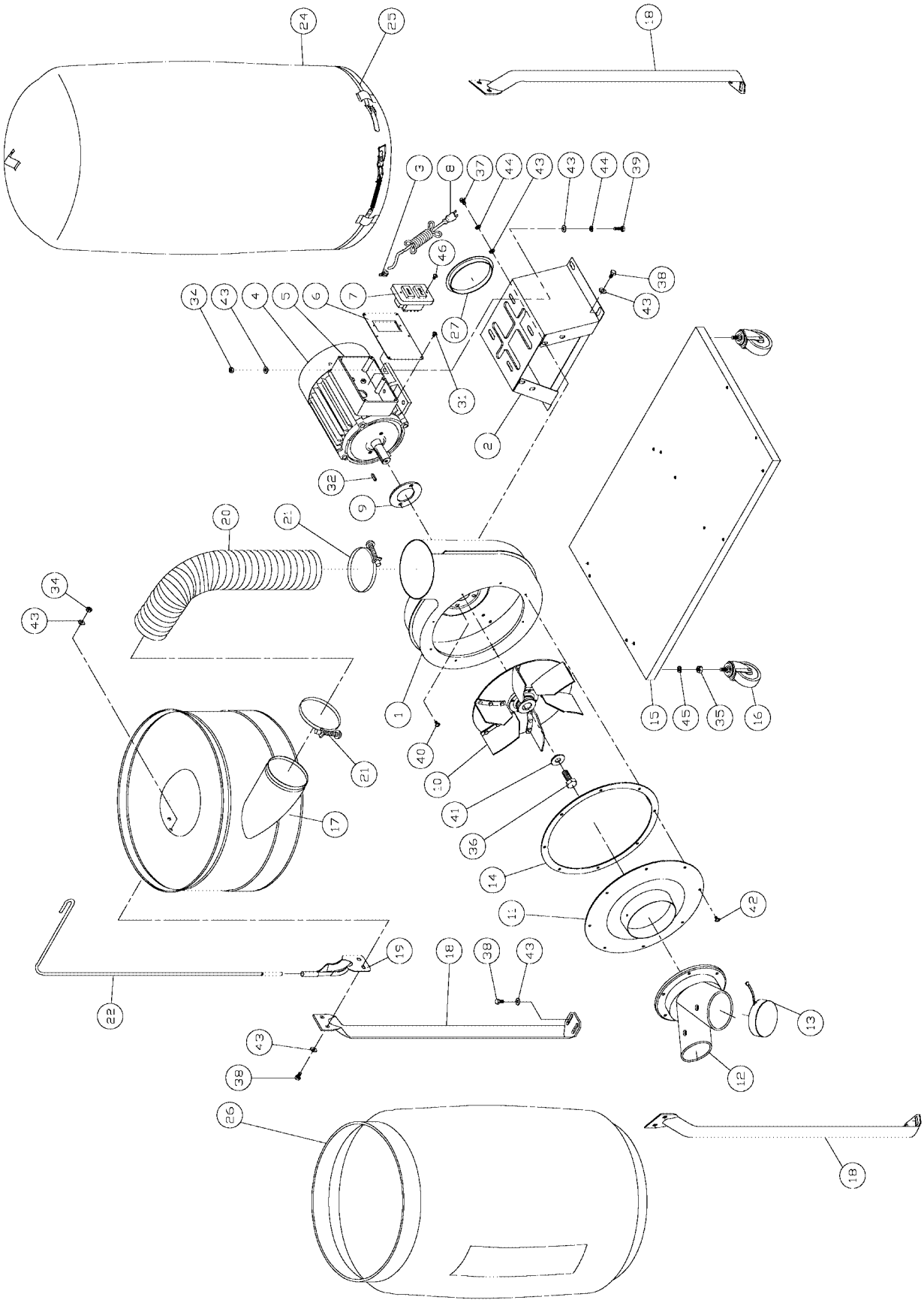

Parts List for the DC-1100A

Index No.	Part No.	Description	Size	Qty.
1	411035W	Impeller Housing		1
2	411026W	Motor Bracket		1
3	998621	Strain Relief		1
4	MA2041J1W	Motor	1-1/2 HP, 1Ph	1
	DC1100-50W	Motor Fan Cover (not shown)		1
	DC1100-51	Motor Fan (not shown)		1
	CA003030	Running Capacitor (not shown)	30MFD, 300V	1
	CA020010	Starting Capacitor (not shown)	200MFD, 125V	1
	DC1100-52	Centrifugal Switch (not shown)		1
	DC1100-53	Centrifugal Switch Rotor (not shown)		1
5	411051	Switch Box		1
6	411053	Switch Plate		1
7	994542	Switch		1
8	999910	Power Cord		1
9	420051	Motor Packing		1
10	AB411040	Impeller	11"	1
11	411036W	Inlet Guard		1
12	427028	Inlet Port	2 @ 4"	1
13	420203	Inlet Cap		1
14	430034	Inlet Flange Packing		1
15	411041W	Base		1
16	402036	Pivoting Caster		4
17	420012W	Housing		1
18	402004W	Support		3
19	523011W	Hanger Bracket		1
20	411009	Hose		1
21	420010	Ring Clamp	5"	2
22	430038	Hanger		1
	424008	Lower Extension Rod (used w/5 micron)		
24	708698	Filter Bag	30 Micron	1
	708706	Filter Bag	5 Micron	
25	AB410012	Retainer Strap		1
26	708699A	Collection Bag		1
27	450038	Bracket Cap		1
31	ST050204	Tapping Screw	M5x10	6
32	KS050525	Key	5x5x25	1
34	TS-1540061	Nut	M8	10
35	TS-0561031	Nut	3/8"-16UNC	4
36	TS-1490031	Hex Head Bolt	M8x20	1
37	TS-1490011	Hex Head Bolt	M8x12	4
38	TS-1490021	Hex Head Bolt	M8x16	16
39	TS-1490041	Hex Head Bolt	M8x25	4
40	TS-1554041	Pan Head Bolt W/Flange	M6x12	2
41	TS-0680031	Flat Washer	M8	1
42	TS-1554041	Pan Head Bolt W/Flange	M6x12	8
43	TS-0680031	Flat Washer	M8	34
44	TS-0720081	Spring Washer	M8	8
45	TS-1551071	Spring Washer	M10	4
46	ST059200	Tapping Screw	M5x8	2
	DC1200-53	Grounding Label (not shown)		1
	DC1200-54	Direction Label (not shown)		1
	DC1100A-ID	I.D. Label (not shown)		1
	DC1100-HP	Hardware Package (not shown)		1
	DC1100-WL	Warning Label (not shown)		1

Wiring Diagram

