

Product and Accessory Guide

2002 Vrs 2.0

DISHWASHERS

WASHERS

DRYERS

ACCESSORIES

INSTALLATION



ASKO

BUILT TO LAST LONGER

www.askousa.com

TABLE OF CONTENTS

Dishwashers

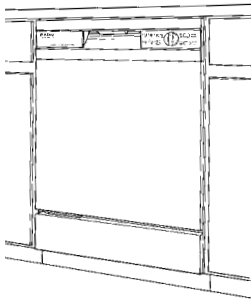

D1706 ... Pg 2

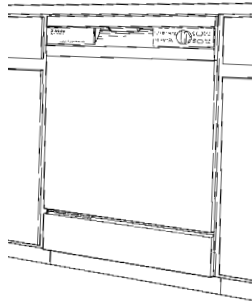

D1716 ... Pg 2

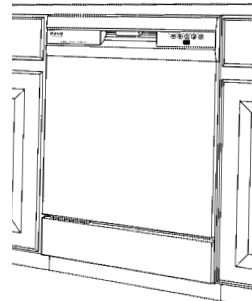

D1776 ... Pg 3

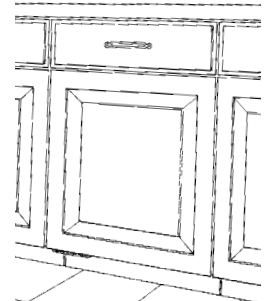

D1796FI ... Pg 3

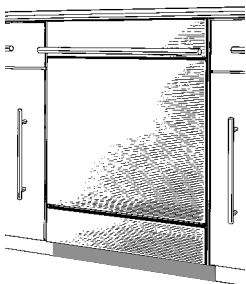

D1996SS &
D1996HNDL ... Pg 4
D1996FI ... Pg 5

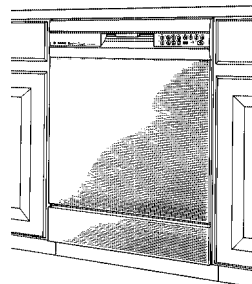

D1976 ... Pg 5

Accessories



Tip Guard

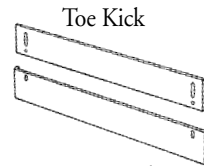

Toe Kick

Pg 6

Installation & Custom Panel Instructions

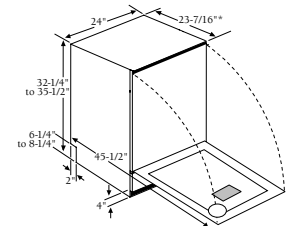

Pg 7-10

Washers

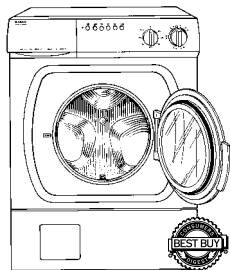

W6021 ... Pg 12



W6441 ... Pg 12



W6661 ... Pg 13

Laundry Accessories

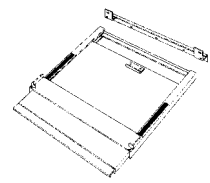

Slide Out Shelf

Pg 17

Dryers

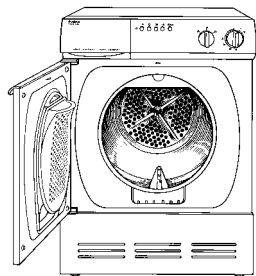

T701 ... Pg 15

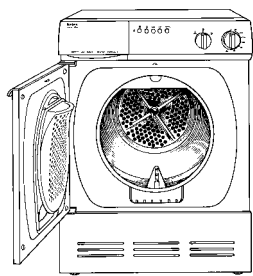

T721 ... Pg 15



T731 ... Pg 16

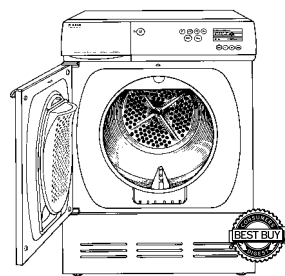

T761/T781 ... Pg 17

Installation Instructions

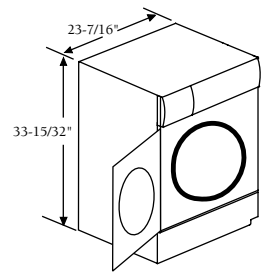

Pg 18

DISHWASHERS

Key Selling Features Of Every ASKO Dishwasher (◆ EXCLUSIVE FEATURES)

- ◆ 20-year life expectancy
- ◆ Exclusive EasyInstall™ system makes installations quicker and easier, now with a rear foot that's adjustable from the front
- ◆ The Quiet System™ ensures this is the quietest line of dishwashers – 30% of units' weight is sound insulation materials
- ◆ Uses less electricity than any other dishwasher – proven by ACE³ (see Energy Star report on page 20)
- ◆ Lowest water consumption: 4.6 gallons on Normal cycle, 3.9 on Light/Quick Wash cycle
- ◆ Patented Super Cleaning System™ produces sparkling results without hand pre-rinsing
- ◆ Anti-jam, auto-reversing drain pump reduces service calls
- ◆ More 18:8 surgical-quality stainless steel components that won't chip or rust (tank, filters, spray arms, bottom, inner door liner, fill tube, glide rails, wash arm support spindles, wash arm lock nut)
- ◆ One-piece, sealed, galvanized-steel base pan (22-25 microns of electroplated, hot-dipped zinc galvanization)
- ◆ Stainless steel ball bearings in upper basket rack glides
- ◆ Graphite-nylon Viscant™-coated baskets with double-coated tines
- ◆ Self-cleaning, triple filtration system
- ◆ Five-way Aqua Block water containment system
 - 1/4-horsepower drain motor and pump
 - 1/2-horsepower circulation motor and pump
 - Large-capacity baskets provide exceptional flexibility and hold 12 place settings, 20% more than most others
 - Deep upper basket holds salad plates and tall iced tea glasses
 - Lower basket holds thick, 12" plates
 - True random loading because there is no space-stealing water tower to limit loading flexibility
 - Removable cutlery basket with lidded small-item basket
 - Separate drain and circulation pumps and motors reduce noise and energy and water consumption
 - Adjustable optical rinse aid dispenser
 - Upper and lower baskets can be removed from unit for faster unloading
 - Lower basket rolls completely out of unit for easier access
 - Balanced door lets the user reduce the amount of bending because it will remain in whatever position is most convenient, e.g., open just far enough to load/unload top rack
 - Energy-saving air-dry option
 - Four-way adjustable toe kick: in/out and up/down
 - Height adjustable from 32-1/4" to 35-1/2" so it easily complies with ADA (Americans with Disabilities Act) installations
 - Accepts custom door panels (except D1996SS and D1996HNDL)
 - Adjustable door springs handle normal custom door panels (up to 7 lbs.)
 - Two optional door springs handle heavier custom door panels (7-12 and 12-22 lbs.)
 - Child safety latch (except D1796FI, D1996SS, D1996FI and D1996HNDL)
 - Every unit 100% factory tested for a minimum of 2-1/2 hours
 - cUL approved

WARRANTY:

3 YEAR: All parts and labor

4-5 YEARS: All parts for solid state controls, timers, motors, pumps and racks

LIFETIME: Stainless steel tank, parts

(See Warranty Certificate for complete details).



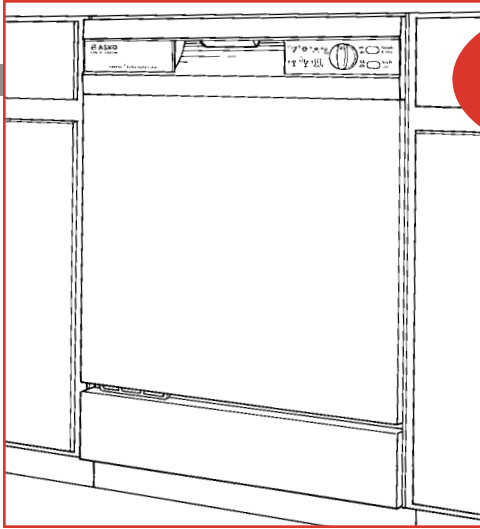

D1706

SKUs	Black	White	Stainless Steel
	D1706B	D1706W	D1706SS
Shipping Weight	101 lbs.	101 lbs.	106 lbs.

Additional Features Of The D1706 (◆ EXCLUSIVE FEATURES)

- ◆ Six-way wash system
- ◆ Adjustable cup shelf
- Dial and push-button controls
- Seven programs: Pots and Pans, Normal, Light, Quick, Plate Warm, Rinse and Dry, and Rinse and Hold
- Two wash and rinse temperature options: household hot water setting and 140° F
- Heated dry option
- Optional black and white trim kits for custom door panels
- Child safety door latch prevents accidental entry

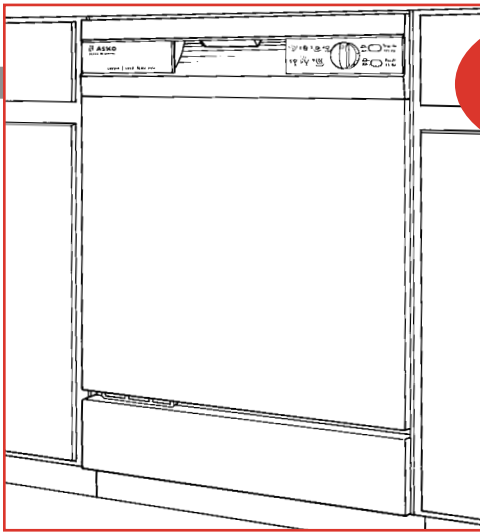

D1716

SKUs	Black	White	Bisque	Stainless Steel
	D1716B	D1716W	D1716BI	D1716SS
Shipping Weight	101 lbs.	101 lbs.	101 lbs.	106 lbs.

Step-Up Features Of The D1716

- Turbo Fan™ Drying System produces drier dishes
- Separate cup and wine goblet racks that protect stemware
- Removable and adjustable plate rack in lower basket
- Two wash and rinse temperature settings: 130° F and 150° F
- Knife Guard provides safe place to load sharp and pointed utensils

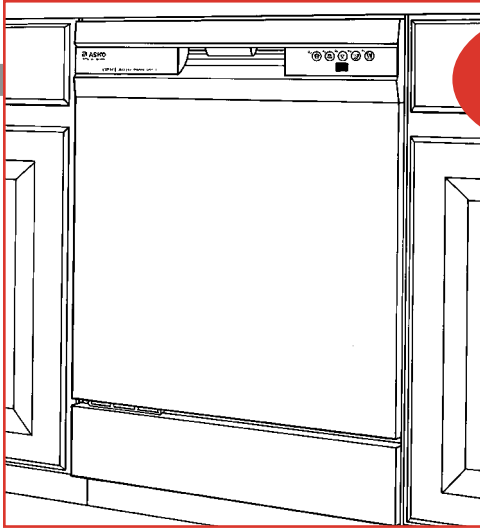

D1776

SKUs	Black	White	Stainless Steel
	D1776B	D1776W	D1776SS
Shipping Weight	101 lbs.	101 lbs.	106 lbs.

Step-Up Features Of The D1776

- Electronic, programmable, push-button controls
- Time remaining and fault indicator LED readout
- Four programs: Pots and Pans, Normal, Rinse and Hold, and Quick
- Two wash temperature settings: 130° F and 160° F
- Two rinse temperature settings: 130° F and 150° F
- Adjustable drain cycle for unusual installations
- Diagnostic control system

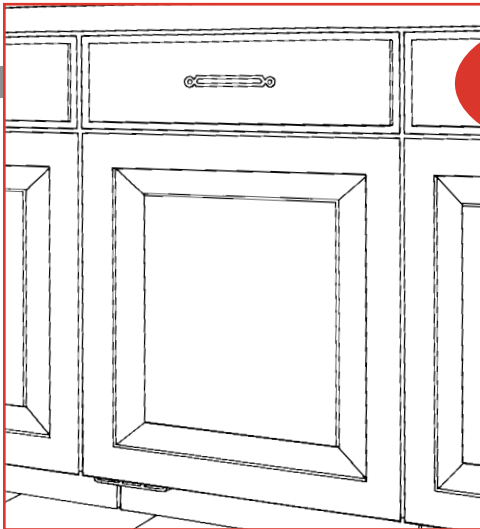

D1796FI

SKUs	Stainless Steel
	D1796FI
Shipping Weight	101 lbs.

Step-Up Features Of The D1796FI (◆ EXCLUSIVE FEATURES)

- ◆ Optional white, black, bisque and stainless steel doors with matching curved handles available (see page 6)
- ◆ Optional brass-like handle also available (see page 6)
- Separate start/stop button
- Controls on top of door are hidden when door is closed (unit shown with an example of an owner-supplied custom door)
- Two wash temperature settings: 130° F and 150° F
- Two rinse temperature settings: 130° F and 150° F
- No trim kit required. Pre-drilled door easily accepts custom panel
- Includes 12-22 lb. door springs (red)
- Unit is 23-5/8" wide

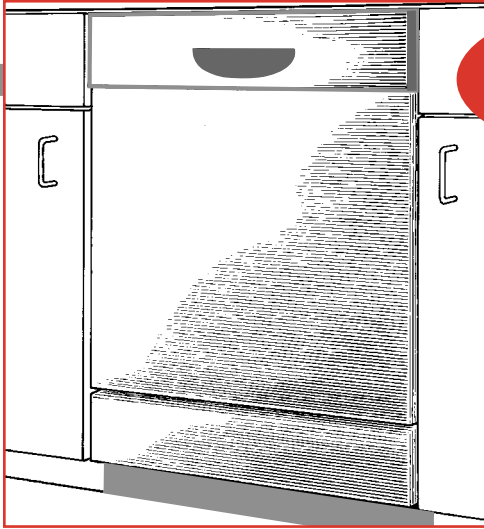

D1996SS

SKUs Stainless Steel

D1996SS

Shipping Weight 110 lbs.

Step-Up Features Of The D1996SS (◆ EXCLUSIVE FEATURES)

- ◆ Quiet System and Extra Quiet Package make these units the quietest dishwashers on the market
- ◆ Safe & Handy™ Upper Cutlery Basket
- ◆ Seven-Way Omni-Spray™ wash system ensures sparkling results every time (includes special spray for Safe & Handy Upper Cutlery Basket)
- ◆ Split upper-rack shelves increase loading flexibility
- ◆ Separate start/stop button
- Controls on top of door are hidden when door is closed
- Five wash programs: Pots and Pans/Sani-Wash, Quick, Normal, Rinse and Hold, and Economy
- Rinse aid indicator light
- Interior light eases loading and unloading
- Double-inlet water valve reduces potential for leaks
- Unit does not accept custom panels

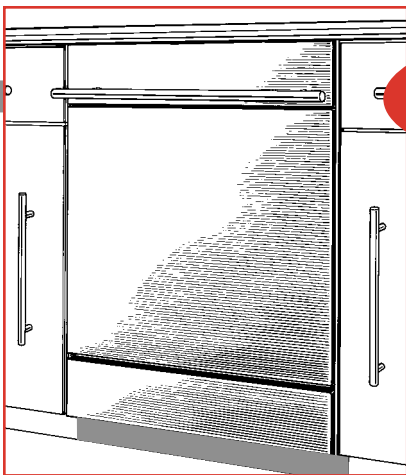

D1996HNDL

SKUs Stainless Steel

D1996HNDL

Shipping Weight 112 lbs.

- Comes with full-width, stainless steel handle
- Does not accept custom panels
- Includes 7-12 lb. door springs (yellow)

D1996FI

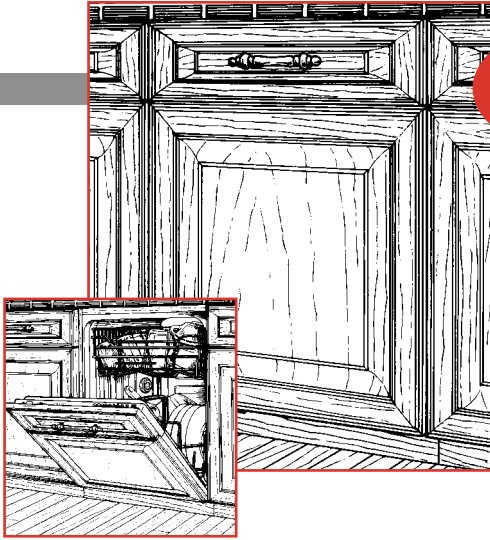

SKUs Stainless Steel

D1996FI

Shipping Weight 105 lbs.

- ◆ Optional white, black, bisque and stainless steel doors with matching curved handles available (see page 6)
- ◆ Optional brass-like handle also available (see page 6)
- Can be installed with an owner-supplied custom panel (Unit shown with an example of an owner-supplied custom panel)
- Unit is 23-5/8" wide
- No trim kit required. Pre-drilled door easily accepts custom panel.
- Includes 12-22 lb. door springs (red)

D1976

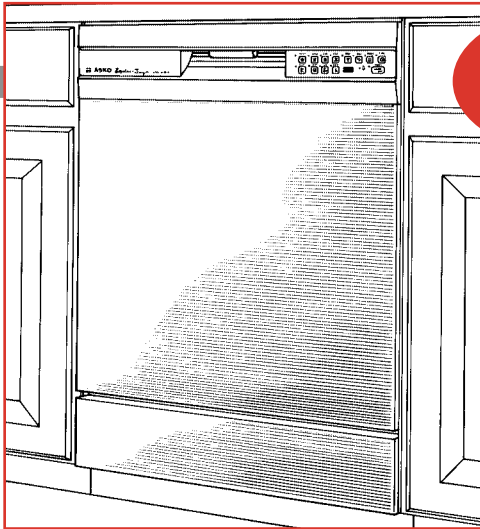

SKUs Black White Stainless Steel

D1976B D1976W D1976SS

Shipping Weight 105 lbs. 105 lbs. 110 lbs.

Step-Up Features Of The D1976 (◆ EXCLUSIVE FEATURES)

- ◆ Five wash temperatures: 110°F, 130°F, 150°F, 160°F and 170°F
- ◆ Upper rack has twice the number of support rails for superior small item containment
- Eight wash programs: Pots and Pans/Sani-Wash, Super, Normal, Light, Quick, Rinse and Dry, Rinse and Hold, and Economy
- Time delay start (1 – 12 hours)
- No-heat Turbo Fan Dry option (Fan Cool)
- Three rinse temperatures: 110°F, 130°F and 150°F

OPTIONAL DISHWASHER ACCESSORIES

Curved Handle for Fully Integrated Dishwashers

8073718-0 White

8073718-29 Black

8073718-84 Bisque

8073718-82 Brass-Like

8073718-95 Stainless Steel

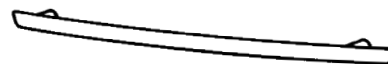

Metal Top Fill Strip

Attaches to top of FI units and fills gap between tank and counter top.

8073869-95



FI Side Fill Strips, Stainless Steel

Fills gap when FI unit installed in 24" wide opening. Both pieces required for each installation.

8074248-95 Right

8074249-95 Left



One-Piece Door with Handle

Only available for D1796FI and D1996FI

One-piece door with matching one-piece, curved handle. These doors cannot be used in ADA (<34") installations.

8072856-0 White

8072856-84 Bisque

8072856-29 Black

8072856-95 Stainless Steel

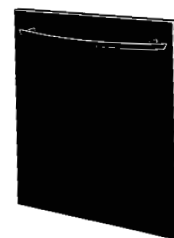
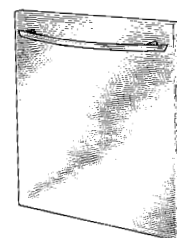
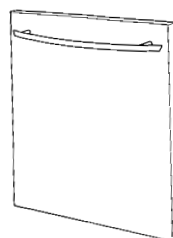

1/4" Trim Kits

Models D1706, D1716, D1776 and D1976

8070850-0 White trim kit for installing 1/4" custom panels

8070850-29 Black trim kit for same installation and units as above

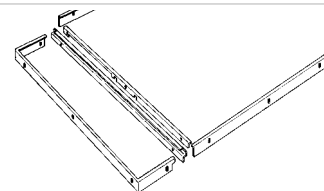

European Toe Kick (Two Pieces)

8070121-0 Extension

8057528-0 Toe Kick

White European toe kick to accommodate 6" toe space on models D1796FI, D1996FI and D1976CSTM. Two pieces are 23-1/2" wide.

8070121-29 Extension

8057528-29 Toe Kick

Black toe kick for same installation. Two pieces are 23-1/2" wide.

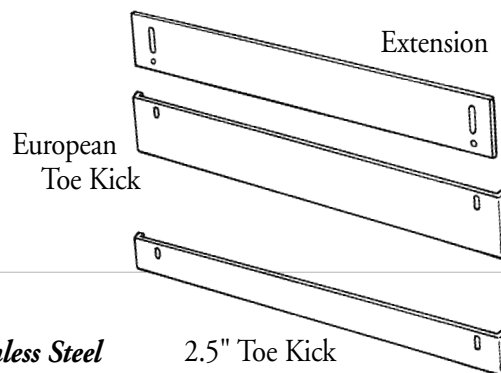

2.5" Toe Kicks

805SC-W White

805SC-B Black

805SC-SS Stainless Steel

2.5" Toe Kick

Dishwasher Tip Guard

8070851

Secures dishwasher when it's not possible to attach it to cabinetry or counter top

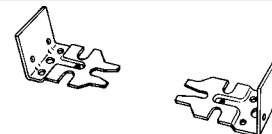

Two Heavy-Duty Door Springs

• 7-12 lbs.: 8060232-77 (Yellow) (Standard on the D1976CSTM)

• 12-22 lbs.: 8071323-77 (Red) (Standard on all FI dishwashers)

Provide additional support for custom panels



Replacement Dishwasher Baskets

8801200-36

Lower basket for all models has removable tines

8801199-36

Upper basket for all models has a split cup rack and a stemware rack

INSTALLATION & CUSTOMIZATION

Standard Dishwashers

ASKO dishwashers will fit in both American and European cabinets. The leveling legs can accommodate virtually any height requirement, including installations under 34" counters that comply with Americans with Disabilities Act (ADA) requirements. Toe kick space is also adjustable.

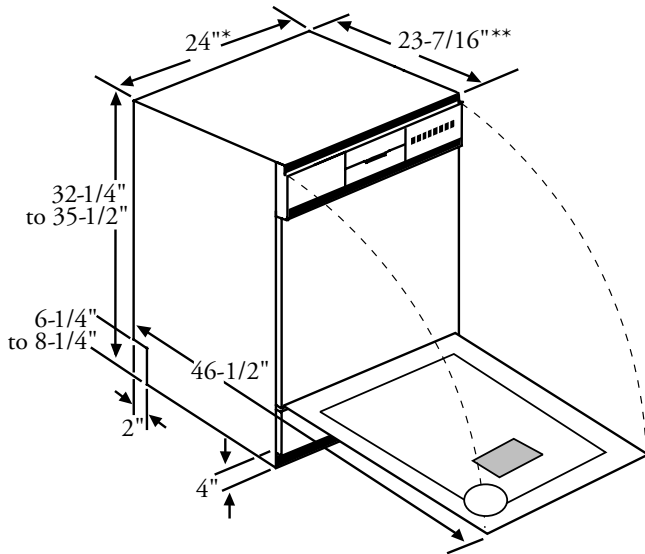

*24" from fill strip to fill strip.

**23-7/16" depth includes space for high-loop drain hose.

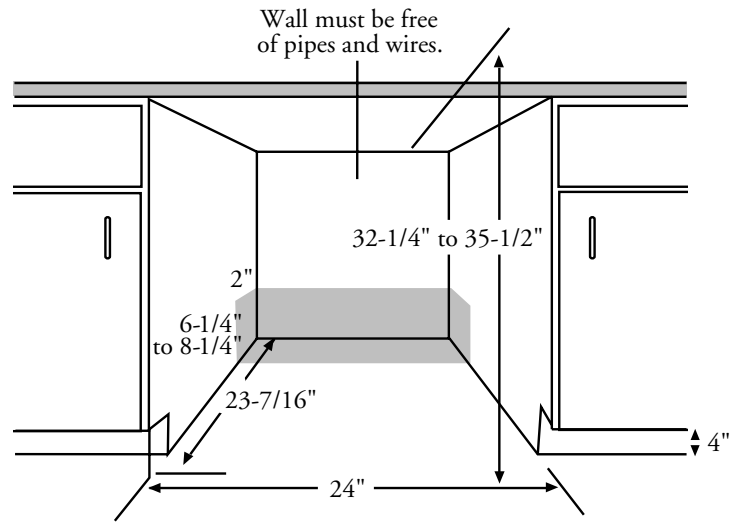

Electrical and water supply should enter through the shaded area and come up through the right side of the machine. Maximum of 4" from the back wall and 8" from the floor. There cannot be any electrical connections in this area.

For standard NON-raised panels, use 1/16" up to 1/4" material. For custom raised panels, the decor trim will accept up to 1/4" flange. The raised panel can be mounted on a backing sheet cut to fit as shown.

- Backing sheet dimensions: Upper - 23-3/16" w. x 21-3/16" h.; Lower - 23-3/16" w. x 4-3/16" h.
- Raised portion dimensions: Upper - 21-3/16" w. x 17-15/16" h; Lower - 21-3/16" w. x 2-3/16" h.

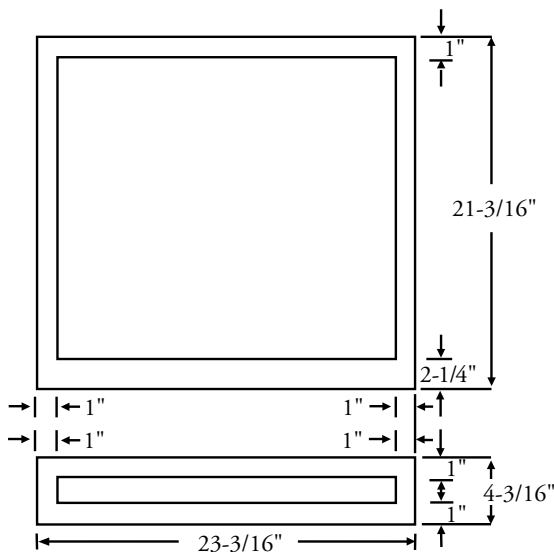

Custom panel dimensions

See the Dishwasher Installation Instructions for detailed information.

D1996SS and D1996HNDL (Handle)

Even though the controls are on the top of the door, these units install like a standard ASKO dishwasher. They fit in American (4" toe kick) cabinets with a 24" wide opening. They will not accept a custom panel.

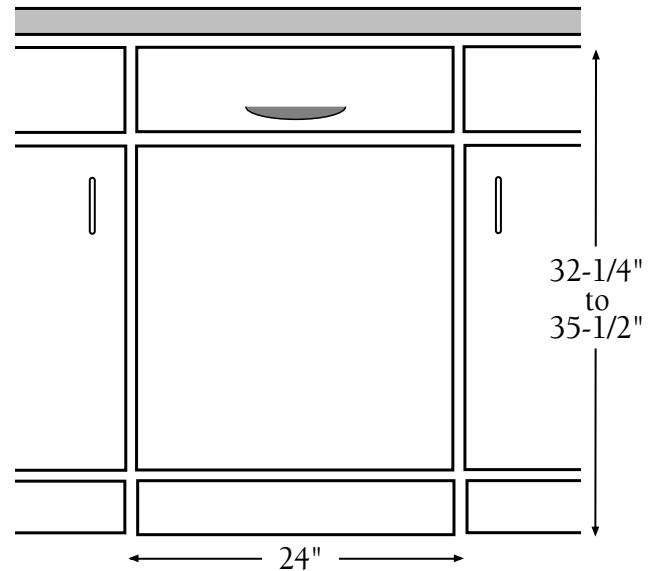
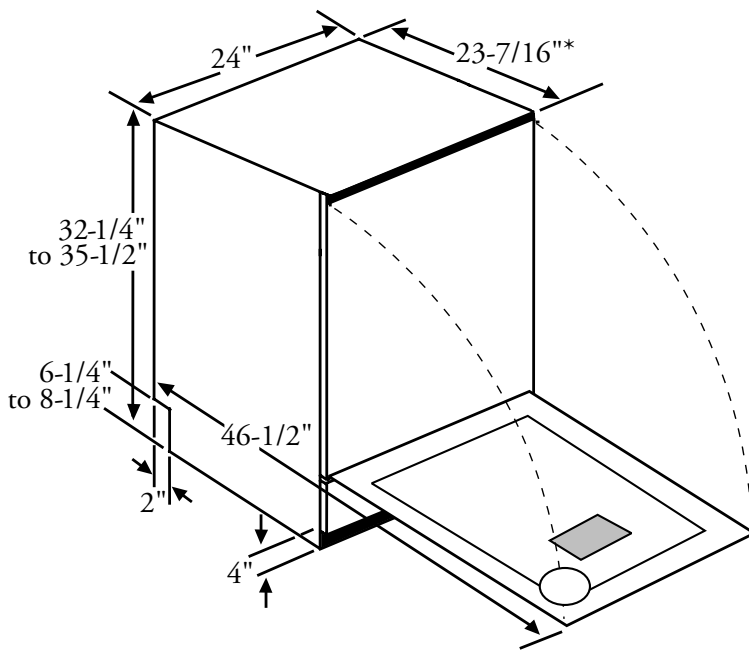

*23-7/16" depth includes space for high-loop drain hose.

D1796FI and D1996FI (Fully Integrated)

These units were built for European cabinets (6" toe kick). However, the toe kick will accommodate American cabinets (4" toe kick). In American-height cabinets, a 2" filler strip above the unit will be necessary. This is an excellent place for a pull-out cutting board. The unit's width is 23-5/8", 3/8" narrower than standard domestic dishwashers, so it easily installs in European and American cabinets.

They come only in stainless steel. The control panel (hidden under the counter top) and toe kick are metallic colored. A black toe kick can be purchased separately, if desired. (See dealer.) If the homeowner prefers, the toe kick can be covered with the same baseboard used in the kitchen. It is not recommended that the baseboard running in front of the unit and the cabinets be one continuous piece. Should the unit ever have to be removed, it is much easier if the baseboard in front of the dishwasher can be removed separately.

These units have a special locking system so they can be installed with a custom panel. This panel can match the cabinets, with a drawer front, a cabinet door and matching hardware. It is recommended that a handle be used for opening the dishwasher. A knob may not provide enough grip.

They come with everything needed to make the installation easy. The dishwasher's door is pre-drilled for the panel's mounting screws. The Turbo Fan Drying System's vent is adjustable and must extend below the custom panel. The lower access panel has been eliminated to give the unit its single door appearance.

See the Dishwasher Installation Instructions for detailed information.

4" Toe Kick Installations – D1796FI and D1996FI with Custom Panel Door

Where the custom panel's height matches the dishwasher's door, a 2" decorative fill strip or cutting board must be used to fill the area between the panel and the counter top (A). For this installation, the custom door panel dimensions are 23-1/2" wide x 28-1/8" high. The opening width is 23-3/4", 3/8" narrower than standard domestic dishwashers.

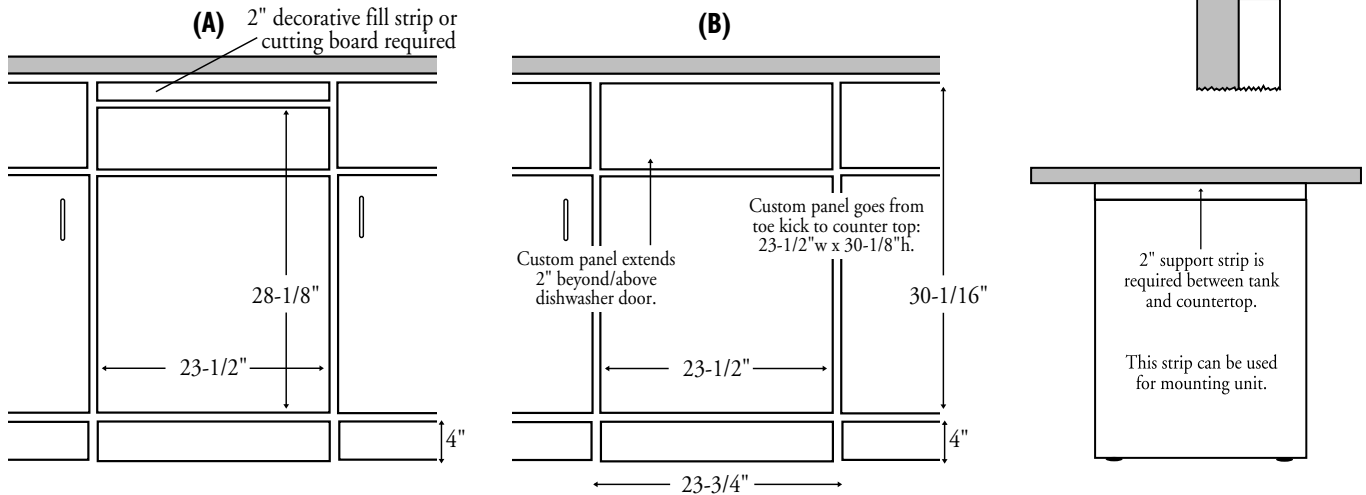

Another installation option for 4" toe kick cabinets is to extend the door panel 1-3/4" above/beyond the control panel (B). This eliminates the need for a 2" decorative fill strip. This door panel is 23-1/2" wide x 30-1/8" high (two inches higher than previous option). This also means a 2" support strip must be installed between the tank and the counter top to fill the gap. Even though, like all ASKOs, the D1796FI and D1996FI can be mounted with screws going through the sides, this support strip can also be used for anchoring the unit from the top. A popular and more finished looking installation is to use the metal top fill strip shown in Dishwasher Accessories (page 6). It fills the gap between the top of the tank and the counter top. When used, the dishwasher is mounted with screws through the sides of the tank into the sides of the cabinets. The custom door panel should be at least 3/4" thick.

6" Toe Kick Installations – D1796FI and D1996FI with Custom Panel Door

For 6" toe kick installations, fill strips are unnecessary. These units install like a standard ASKO dishwasher.

Installing the custom panel is simple. No additional trim kit is needed. Four screws go through the dishwasher's pre-drilled door and into the back of the panel. The screw heads are completely hidden when the door is closed.

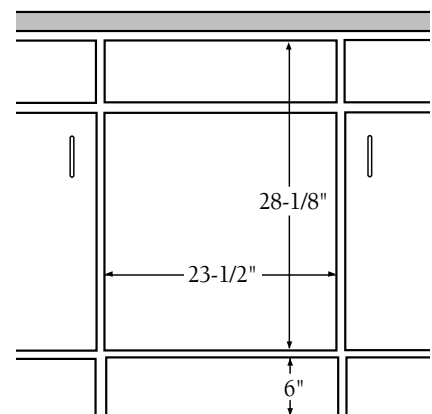

See the Dishwasher Installation Instructions for detailed information.

Electrical And Water Requirements – EasyInstall™ Dishwashers

ASKO's dishwashers come with all the connections you need. We've eliminated the need to get into the electrical and mechanical area, which makes installation simple and quick. If a dishwasher is being installed in an area for the first time, most of the cabinetwork, plumbing, and electrical has to be done before you move the machine into place. If you are replacing an old dishwasher, you must check the plumbing connection and wiring before you install the new dishwasher.

This system has these components which have been approved by regulatory authorities (cUL):

- Over 5' of Pex hose that replaces the water-inlet copper tubing. It has a 3/8"-compression fitting that mates with the shut-off valve. Length: 5'2" from back of unit.
- Over 6' of drain hose with an adaptable drain connection. The high loop is built into this hose on the back of the unit. If this loop is removed to lengthen the hose, another high-loop must be built into the installation somewhere along the line (typically where the hose passes through the cabinet). Length: 6'6" from back of unit.
- A 6' long electrical cord with standard, 3-pronged, 110V plug. This eliminates the need to wire anything under the unit.

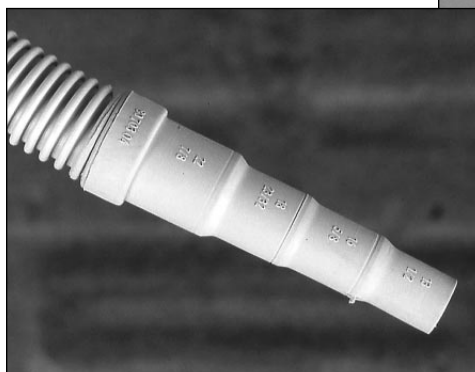

Drain hose with multiple size adaptor.

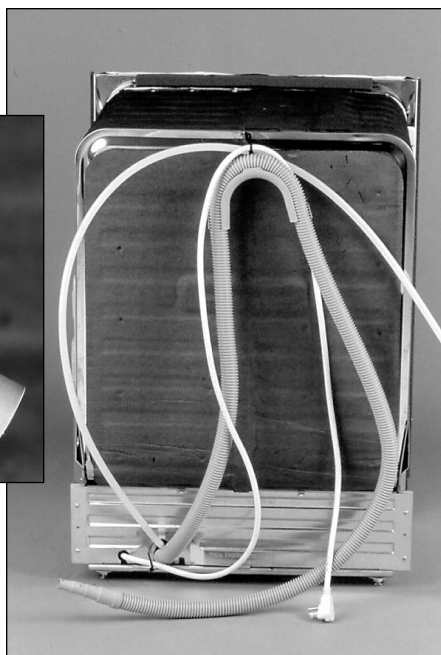

Back of ASKO dishwasher with EasyInstall system.



Each unit comes already wired with a standard three-pronged plug.



Pex hose with 3/8" brass fitting.

CLOTHES WASHERS

Key Selling Features Of Every ASKO Washer (◆ EXCLUSIVE FEATURES)

- ◆ 20-year life expectancy
- ◆ Large, easy-access door opening
- ◆ Super Quick Wash program washes smaller or lightly-soiled loads in only 34 minutes, yet uses as little as 5.7 gallons of water and 0.3kWh (2¢) of electricity
- ◆ Quick Wash program washes full loads and rinses three times in only 45 minutes with only 9.3 gallons of water and 0.9kWh (6¢) of electricity.
- ◆ Quattro™, four-shock suspension, Automatic Load Balancing System, cast-iron counterweights, and heavy-duty bearings control load balancing and provide virtually vibration-free spin cycles for quiet operation – also prevent walking and allow for stacking of units
- ◆ Solid rubber SmartSeal™ door gasket eliminates troublesome bellows gasket seal that can leak and collect detergent and soil residue
- ◆ Uses less electricity than any other washer (according to DOE and FTC test procedures)
- ◆ Multiple, adjustable programs
 - Additional plug or wiring is unnecessary because ASKO dryer has 220V receptacle for ASKO washer. This eliminates the need to purchase an expensive dual-outlet splitter box or to have an additional 220V line run for the washer.
 - Capacity as large as any top-loader: up to 14 bath towels
 - Smaller exterior size and quiet operation allow for installation in more convenient locations, e.g., in closets or under counters in bathrooms, utility rooms, and kitchens
 - Tumble action, precise temperature controls, optimal wash time, less detergent and elimination of bleach produce significantly cleaner, fresher-smelling laundry and extend the life and beauty of clothing
 - High-lift ribs raise laundry to optimal height before dropping into water, increasing wash action effectiveness. Ribs also shower laundry with water to enhance cleaning action
 - Sensor Level Control System automatically determines the correct amount of water for every load
 - Can save 15,000 gallons of water annually. Super Quick Wash uses 5.7 gallons per load on average; Normal Wash uses 15. Typical old-style agitators use an average of 44 and domestic front loaders use 28.
 - An ASKO washer can save over \$200 annually in water, electricity, detergent, and bleach costs.
 - Stainless steel, electro-polished interior drum is snag-free, more gentle to clothes, and more durable than porcelain or plastic
 - Built-in water heater provides optimal temperatures (Cold, 85° – 205° F) for better cleaning and energy savings by eliminating need to use home's less efficient water heater
 - Cold water fill helps remove protein stains, such as blood, as well as wine and grape juice
 - High spin speeds (up to 1,600 rpm) remove up to 94% of water that can be extracted by centrifugal force (spinning) – reducing time and energy consumed by dryer and extending life and beauty of clothing
 - Up to seven rinses remove virtually every trace of detergent and soil
 - Both units can run off a single, standard 30 amp circuit
 - Child-proof controls and electronic door latch
 - Dual, internal fuse protection
 - Easy-to-reach, out-front controls
 - Anti-jam, auto-reversing drain pump reduces service calls
 - Rust- and chip-proof stainless steel inner and outer tanks
 - Automatic detergent and fabric softener dispenser
 - Removable, washable detergent compartment
 - Stackable when paired with ASKO dryer (kit included with dryer)
 - Every unit 100% factory tested for a minimum of 2-1/2 hours
 - cUL approved

WARRANTY:

3 YEAR: All parts and labor

4-5 YEARS: All parts for electronic controls, timers, motors, and pumps

LIFETIME: Stainless steel drum, parts

(See Warranty Certificate for complete details).



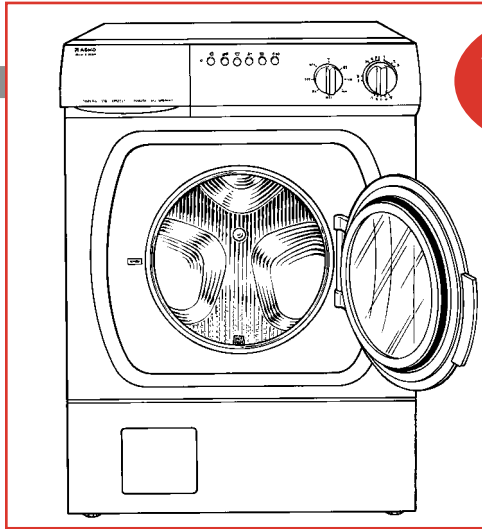

W6021



SKUs	White
	W6021
Shipping Weight	161 lbs.

Key Features Of The W6021 (◆ EXCLUSIVE FEATURES)

- ◆ Six-way Aqua Block Water Containment System
- ◆ Electronic dial and push-button controls
- ◆ 800 and 1200 rpm spin speeds
- ◆ Adjustable water temperature: Cold, 85° – 205° F
- ◆ Child-proof temperature lock
- Large tub door opening
- Removable pin trap
- No-spin option
- Separate Wool and Hand Wash programs



W6441

SKUs	White
	W6441
Shipping Weight	174 lbs.

Step-Up Features Of The W6441 (◆ EXCLUSIVE FEATURES)

- ◆ EasyControl™ system with program dial, option buttons and LCD window
- ◆ 11 programs are denoted around knob on control panel.
- ◆ LCD window shows temperature, estimated running and remaining time, and available options.
- ◆ New Anti-Crease program (*first ever in a washer*) greatly reduces wrinkles before clothing goes in the dryer. After the last spin, the tank rotates for three seconds every minute for up to two hours or until the door is opened.
- Remembers last program used and automatically repeats program unless changed.
- Time delay start (1-24 hours)
- Seven wash temperature options (85° F to 205° F)
- 400-1400 rpm spin speeds, adjustable
- SensiSave water & energy saving system
- Program interrupt, add-an-item feature

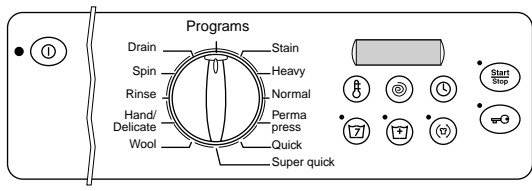

- ◆ Six option features (buttons) are denoted on detergent drawer: temperature, spin speed, delay start, Super rinse, high water and anti-crease.



W6661



SKUs	White	Stainless Steel
	W6661W	W6661SS
Shipping Weight	183 lbs.	193 lbs.

Step-Up Features Of The W6661 (◆ EXCLUSIVE FEATURES)

- ◆ Quiet Package
- ◆ EasyControl™ system with four-button operation
- ◆ Seven-way Aqua-Block Water Containment System with float-activated shut-off valve
- Available with stainless steel exterior with a black control panel and inner cabinet
- Adjustable spin speeds (400 – 1600 rpm) for a spin about twice as fast as an old-style agitator or domestic front-loader
- Convenience door drops down for easy loading and unloading

Key Selling Features Of Every ASKO Dryer (◆ EXCLUSIVE FEATURES)

- ◆ 20-year life expectancy
- ◆ Butterfly Drying™ System's offset paddles help move clothing from front-to-back and back-to-front in drum to prevent wrinkles. One-direction rotation also extends motor life
- ◆ Cleanable, air-flow fan
- ◆ Adjustable cool down for every heated cycle
- Additional plug or wiring is unnecessary because ASKO dryer has 220V receptacle for ASKO washer. This eliminates the need to purchase an expensive dual-outlet splitter box or to have an additional 220V line run for the washer.
- Stainless steel, electro-polished interior drum is snag-free, more gentle to clothes, and more durable than porcelain or plastic
- Anti-crease program
- Large capacity drum also reduces wrinkles
- Can be stacked when paired with ASKO washer – stacking kit included
- Up to 90 minute, time-controlled drying program
- Air, low and normal temperature programs
- End-of-program buzzer
- 20-minute Air (fluff) drying program
- Three-way venting
- Easy-to-reach, out-front controls
- Easy-access, double lint filter
- Flush, swing-out door can be hinged on left or right
- Only needs one 220V, 30 amp outlet (like any standard US dryer)
- Every unit 100% factory tested for a minimum of 2-1/2 hours
- cUL approved

LAUNDRY WARRANTY:

3 YEAR: All parts and labor

4-5 YEARS: All parts for electronic controls, timers, motors, and pumps

LIFETIME: Stainless steel drum, parts

(See Warranty Certificate for complete details).

Do not pair with a top-loading washer; those washers spin too slowly to remove enough moisture to allow for efficient drying.





T701

SKUs	White
	T701
Shipping Weight	86 lbs.

Key Features Of The T701

- Timed and automatic drying programs
- Electro-mechanical and push-button controls
- Vented
- Reversible door on all models
- Three temperatures: Normal, Low and Air
- Four drying programs: Extra Dry, Dry, Timed Dry and Air (Fluff) Dry
- Two cool-down options: Normal and Quick

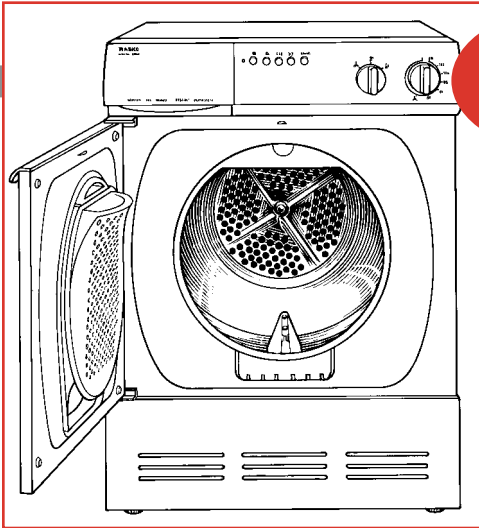

T721

SKUs	White
	T721
Shipping Weight	104 lbs.

Step-Up Features Of The T721 (◆ EXCLUSIVE FEATURES)

- ◆ Five-way water containment system
- ◆ Internal moisture condenser eliminates need for external wall venting
- Two drying programs: Timed Dry and Air (Fluff) Dry



T731

SKUs	White
	T731
Shipping Weight	86 lbs.

Step-Up Features Of The T731 (◆ EXCLUSIVE FEATURES)

- ◆ EasyControl™ system with program dial, option buttons and LCD window
- ◆ Six programs are denoted around knob on control panel.

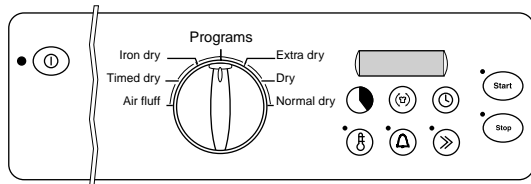

- ◆ LCD window shows: SensiDry™ program selected, time when a timed-drying program selected, number of minutes when Air Fluff selected, “End” when program is completed, and “C” when in cool-down cycle.
- Remembers last program used and automatically repeats program unless changed.
- Time delay start (1-24 hours)
- Three way venting

- ◆ Six option features (buttons) are denoted on sticker inside door: timed drying (5-90 mnts.), Anti-Crease, Delay Start (1-24 hours), temperature (low-normal), end-of-program buzzer, and cool-down cycle

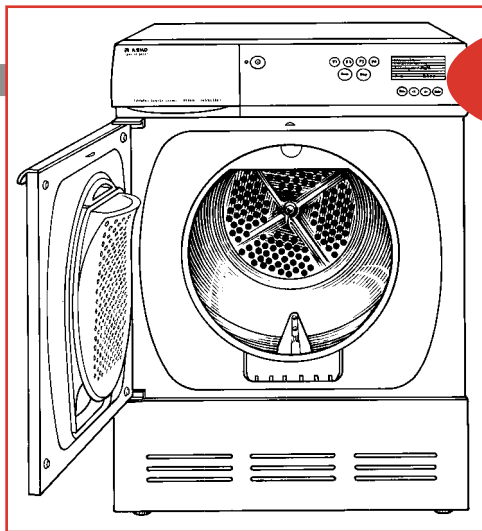

T761/T781



SKUs	White	Stainless Steel
	T761W	T761SS
Shipping Weight	86 lbs.	96 lbs.

Step-Up Features Of The T761 (◆ EXCLUSIVE FEATURES)

- ◆ Available with stainless steel exterior, black control panel and inner cabinet
- ◆ EasyControl™ system with four-button operation
- ◆ Programs can be altered permanently or for one-time use
- ◆ Communicates in 11 languages
- 1–24 hour delay start option
- SensiDry™ program prevents over-drying
- Six drying programs: Extra Dry, Dry, Normal Dry, Iron Dry, Air (Fluff) Dry, and Timed Dry
- 1–3 hour anti-crease option
- Fault indicator
- Epoxy-coated buttons reduce normal wear

Step-Up Features Of The T781

- ◆ Five-way Aqua-Block Water Containment System
- Internal moisture condenser system eliminates need for exterior wall venting

SKUs	White	Stainless Steel
	T781W	T781SS
Shipping Weight	104 lbs.	114 lbs.

LAUNDRY ACCESSORIES

White Space Trim Kit

8063981

Installs between stacked pair to provide a single unit appearance

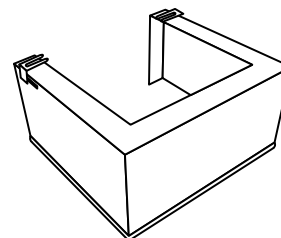

Slide-Out Shelf

8061907-0 White

8061907-26 Black

Installs between stacked pair
Extends 15" from units

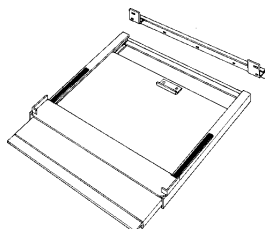

Steel Laundry Platform

8052000 White

8052000-B Black

Will raise a washer or a dryer (one machine per platform) 12" off the floor

INSTALLATION

Laundry

Washers

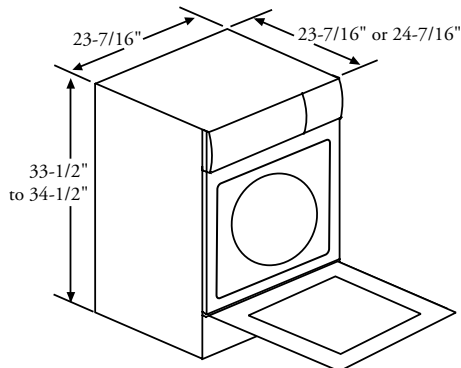

Depth with Door Open
 W6021 — 36-3/8"
 W6441 & W6661 — 42-3/8"

Depth with Door Closed
 W6021 & W6441 — 24-7/16"
 W6661 — 23-7/16"

Dryers

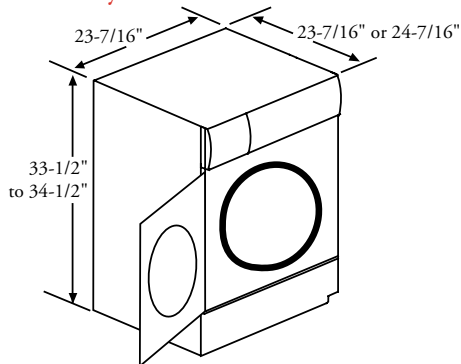

Depth with Door Open
 46-1/16"

Depth with Door Closed
 T701, T721 & T731 — 24-7/16"
 T761 & T781 — 23-7/16"

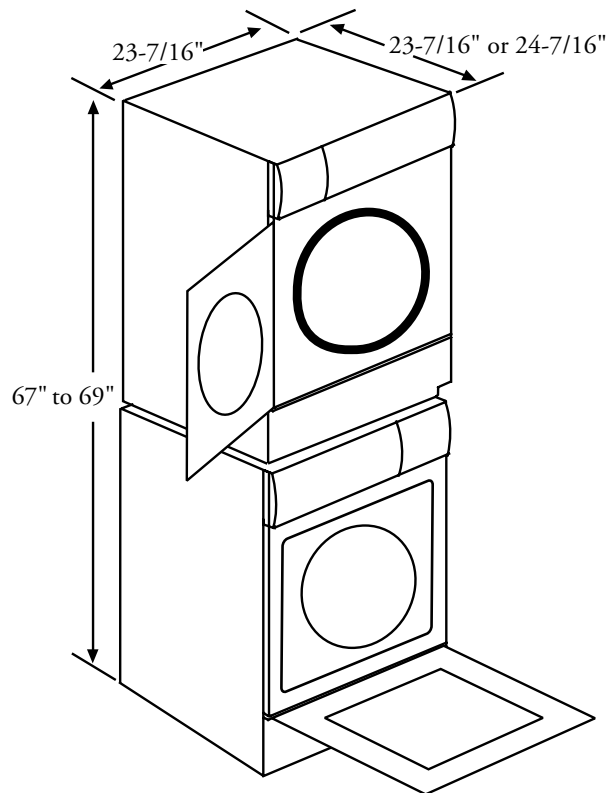

Under Counter Installations

These units can be installed in free-standing installations. This shows the traditional built-in layout: dryer on left and washer on right. To reverse this, simply reverse the installation specs. These units can also be built in under a 34" to 35" high counter. The minimum counter width is 49" for a pair. This 49" width allows 1/2" of space on the outside edges and between the units, otherwise units may bump wall/cabinet or each other during spin cycles. This also allows for sufficient air circulation for dryer.

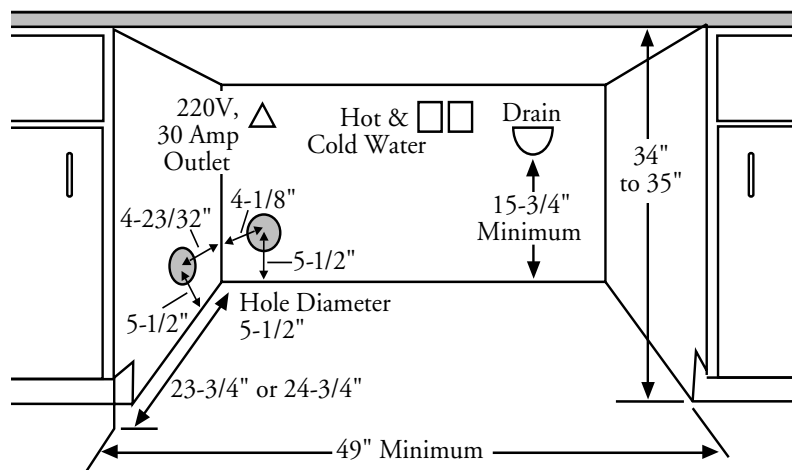

Electrical, Water And Code Requirements

The washers have a 220 V line that plugs into an ASKO dryer or a standard 220 V, 20 amp single phase outlet. ASKO dryers plug into standard 220V, 30 amp circuit. The washers connect to the cold-water outlet. The water pressure must be between 15 – 146 PSI. Second floor (above grade) installations must meet all local building codes.

See Use & Care Guide for detailed installation instructions.

ENERGY STAR QUALIFYING DISHWASHERS

TOP MANUFACTURERS



Money Isn't All You're Saving

The following chart is an edited version of the EnergyStar list. It was condensed so it included only the better-known dishwashers. This chart shows **Brands** and their **Model** number, the total estimated kilowatts (**kWh/Year**) each consumes per year, the **Energy Factor** (a number that enables you to compare the relative efficiency of different units), and (**% Better**) how much each unit exceeds the minimum federal standard in percentages. This chart shows you that ASKO still sets the standards for energy efficiency when comparing comparable-sized units. If you would like more information on this topic, please visit the EnergyStar web site at energystar.org.

Brand	Model	kWh/ Year	Energy Factor	% Better	Lifetime Cost*
Fisher & Paykel	DS602-USA (Only one drawer)	277	1.16	152%	\$296
Asko	D1976	380	0.85	84%	\$406
Asko	D1876	391	0.82	79%	\$417
Asko	D1796	392	0.82	79%	\$418
Asko	D1776	397	0.81	76%	\$424
Asko	D1996	412	0.78	70%	\$440
Asko	D1716	416	0.77	68%	\$444
Asko	D1706	448	0.72	56%	\$478
Miele	G605 & G805	477	0.68	48%	\$509
Kitchen Aid	KUDV25	472	0.68	48%	\$504
Frigidaire	FDB641RJ	498	0.65	41%	\$532
Frigidaire	FDB657RJ - GPDB698J	506	0.64	39%	\$540
Frigidaire	GLDB656J	506	0.64	39%	\$540
Frigidaire	FDB635RF - GLDB653J	514	0.63	36%	\$549
Frigidaire	GLDB957J - GPDB998J	518	0.62	35%	\$553
Bosch	SHI 6802 - SHI6806 UC	520	0.62	35%	\$555
Bosch	SHU 6802 - SHU 6806 UC	520	0.62	35%	\$555
General Electric	GSD3825 - GSD3855F00	520	0.62	34%	\$555
Thermador	DWI246U*	524	0.61	33%	\$559
Kitchen Aid	KUDI01T - KUDS01IJ	526	0.61	33%	\$561
Bosch	SHU 3302 - SHU 5317 UC	535	0.60	31%	\$571
Fisher & Paykel	DD602-USA (Two drawers)	544	0.59	29%	\$581
Bosch	SHI 4302 - SHI 4306 UC	546	0.59	28%	\$583
Miele	G643 - G863	544	0.59	28%	\$581
Bosch	SHU 9922 - SHV 4803UC	556	0.58	26%	\$593

*Cost based on DOE average kWh of 8.21¢ and an average life expectancy of 13 years. (Source: Association of Home Appliance Manufacturers.)

ASKO

BUILT TO LAST LONGER

www.askousa.com

ASKO Inc. • P.O. Box 851805 • Richardson, Texas 75085-1805

Form 051101-0530 © ASKO Inc. 2002

 Underwriters Laboratories, Inc.

 Printed on Recycled Paper

ASKO Inc. retains the right to vary the model specifications at any time. All facts were accurate at time of printing. Before purchasing any ASKO product, read important energy cost and efficiency information available from retailer.

THERE'S MORE TO AN ASKO THAN MEETS THE EYE.



W660 and T760 for 2000



W600 for 2001



Dishwashers selected by 91%
of homeowners as the quietest
in independent tests.



D1996FI Dishwasher



1805 Dishwasher
Excellence In
Design Innovation



All ASKO products are covered
by the Good Housekeeping Seal.



W660 Washer & T760 Dryer



Money Isn't All You're Saving
ASKO dishwashers and washers
meet the Energy Star® requirements.



W660 Washer & T760 Dryer