

ZANUSSI

DISHWASHER ZDI 6895 SX

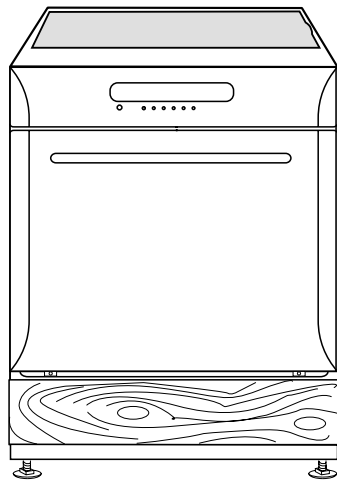

Contents

Important safety information	3
Description of the appliance	3
The control panel	4
Before use	6
Setting the water softener	6
Rinse aid	7
Use of detergent	7
Using your appliance	8
Loading your appliance	8
Adjusting the height of the upper basket	9
Hints and tips	10
Washing programmes	11
Operating sequence	12
Maintenance and cleaning	14
Internal cleaning	14
Cleaning the filters	14
External cleaning	14
Prolonged periods of non-operation	14
Frost precautions	14
Moving the machine	14
Something not working	15
Protection against flooding	16
Service and Spare Parts	16
Customer Care Department	16
Guarantee Conditions	17
Hints for test centres	18
Installation instructions	19
Water supply connections	19
Water outlet hose connection	19
Electrical connection	19

Technical specifications

Dimensions	Width Height Max depth Max depth with open door	59.6 cm 81.8 - 87.8 cm 63 cm 115.9 cm
Electrical connection Motor rating during wash Power of heating element Overall power	Voltage	220/240 V - 50 Hz 200 W 2100 W 2300 W
Water supply pressure	Minimum Maximum	50 kPa (0.5 bar) 800 kPa (8 bar)
Capacity		12 place settings

This appliance complies with the following E.E.C. Directives:

- 73/23 or 19.2.73 (Low Voltage Directive) and subsequent modifications;

- 89/336 or 3.5.89 (Electromagnetic Compatibility Directive) and subsequent modifications.

Important safety information

It is most important that this instruction book should be retained with the appliance for future reference. Should the appliance be sold or transferred to another owner, or should you move house and leave the appliance, always ensure that the book is left with the appliance in order that the new owner can get to know the functioning of the appliance and the relevant safety information.

This information has been provided in the interest of your safety. You **MUST** read it carefully before installing or using the appliance.

Installation

- This appliance is heavy. Care should be taken when moving it.
- It is dangerous to alter the specifications or attempt to modify this product in any way.
- Care must be taken to ensure that the appliance does not stand on the electrical supply cable.
- Any electrical work required to install this appliance should be carried out by a qualified electrician or competent person.
- Any plumbing work required to install this appliance should be carried out by a qualified plumber or competent person.

Child Safety

- This appliance is designed to be operated by adults. Children should not be allowed to tamper with the controls or play with the product.
- Keep all packaging well away from children.
- Keep all detergents in a safe place out of children's reach.

During Use

- Items that are contaminated by petrol, paint, steel or iron debris, corrosive, acidic or alkaline chemicals must not be washed in this dishwasher.
- Under no circumstances should you open the door whilst the appliance is in operation. Always turn off the appliance before opening the door.
- Only use detergent specifically designed for use in dishwashers.

- Long bladed knives stored in an upright position are a potential hazard.
- Long and/or sharp items of cutlery such as carving knives must be positioned horizontally in the upper basket.
- When finishing loading or unloading close the door, as an open door can be a hazard.
- Do not sit or stand on the open door.
- Isolate the appliance from the power supply and turn off the water supply after use.
- Care should be taken when cleaning the bottom door seal and hinge area as any exposed metal edges may cut if care is not taken.
- This product should be serviced by an authorised Service engineer, and only genuine spare parts should be used.
- Under no circumstances should you attempt to repair the machine yourself. Repairs carried out by inexperienced persons may cause injury or serious malfunctioning. Contact your local Service Force Centre. Always insist on genuine spare parts.

Conservation

In the interest of the environment:

- Materials marked with the symbol ♻ are recyclable.
- Check with your local Council or Environmental Health Office to see if there are facilities in your area for re-cycling this appliance.
- When the appliance is to be scrapped, cut off the power supply cable and make the door closing device unusable to prevent young children from being trapped inside.
- Help to keep your country tidy - use authorised disposal sites for your old appliance.

Description of the appliance

1. Levelling spacers
2. Upper basket stop
3. Upper spray arm
4. Salt container
5. Large filter
6. Detergent dispenser
7. Control panel
8. Rating plate
9. Rinse aid dispenser
10. Central filter
11. Lower spray arm
12. Upper basket
13. "SID" detergent dispenser (Super Intensity Dispenser)

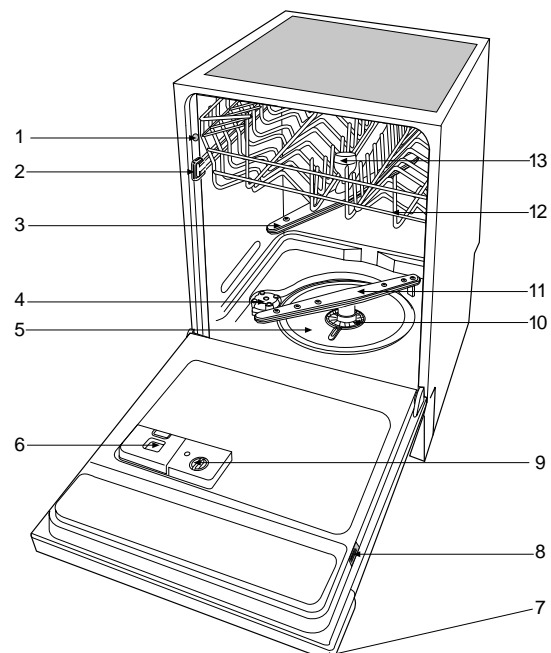

IN84

The control panel

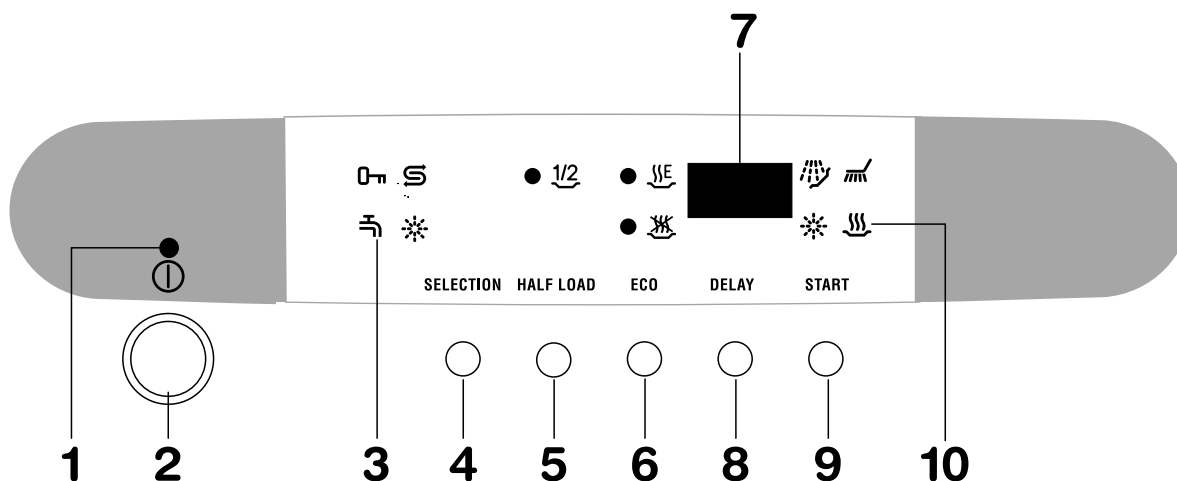

1. On/Off indicator light

2. On/Off push button

3. Indicator lights

Open door

Illuminates when the door has not been properly closed.

Salt

Illuminates when the salt has run out, to remind you to refill the salt container.

Water tap

Flashes when:

- The water tap is closed.
- The mains water supply has been cut off.
- The inlet hose may be blocked.

Rinse aid

Illuminates when the rinse aid has run out, to remind you to refill the rinse aid dispenser.

4. Programme selection push button

For the setting of the wash programme refer to the "Washing programmes" chart.

5. Half load push button

This option is useful and economical when only a few dishes need washing.

The prewash phase will be automatically excluded. Remember to load all the dishes into both baskets.

When this option is selected the corresponding indicator light comes on.

This option is **not** available with the following programmes:

Programme 1 (Rinse and Hold)

Programme 8 (Quick wash 50°C)

Programme 11 (Quick 30')

Programme 12 (Plate warmer)

6. Drying options push button

By pressing this push button you can opt to:

1. reduce the temperature of the drying phase (**Eco Dry**)

2. reduce the temperature of the water in the last rinse (**No Dry**)

The indicator light corresponding to the selection will come on.

 **Eco Dry**

 **No Dry**

This option is not available with the following programmes:

Programme 1 (Rinse and Hold)

Programme 8 (Quick wash 50°C)

Programme 11 (Quick 30')

Programme 12 (Plate warmer)

If both indicator lights are off, the normal drying phase will be carried out.

7. Digital display

8. Delay start push button

Allows the start of the programme to be delayed by a minimum of 1 hour, up to 12 hours.

9. Programme start push button

This is the last push button to press after having set the programme and closed the door.

It starts the programme.

10. Programme phase indicator lights

Each phase is indicated with a symbol:

 Prewash / Rinse and Hold

 Wash

 Rinse

 Drying

As soon as you select a washing programme, this illuminates all the phases the programme consists of.

As the programme progresses, the phase under way will illuminate.

At the end of the programme the phase indicator lights turn off.

Audible signals

Audible signals have been introduced to help indicate which operations the dishwasher is performing.

Short "instruction accepted" signal

When any of the push buttons are pressed (except the On/Off push button), a short audible signal informs you that the machine has accepted the instruction given.

Long "programme run" signal

A continuous audible signal informs you that the washing programme is starting.

Intermittent "end of programme" signal

An intermittent audible signal informs you that the wash programme has ended.

"Alarm" intermittent signal

The machine is fitted with a number of alarm systems to help you determine the cause of any problems (see "Something not working").

An intermittent audible signal informs you that an alarm is activated.

To deactivate these audible signals, press simultaneously and keep pressed both **HALF LOAD** and **DELAY** push buttons for about 5 seconds, until you hear 3 short intermittent audible signals, this means that the audible signals have been deactivated.

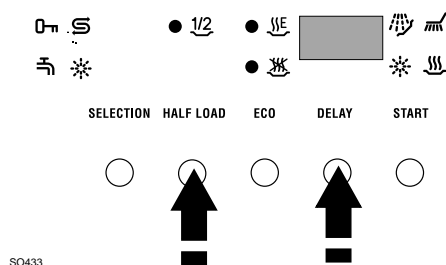

To reactivate these audible signals, press simultaneously and keep pressed both **HALF LOAD** and **DELAY** push buttons for about 5 seconds, until you hear 3 short intermittent audible signals, this means that the audible signals have been reactivated.

Both operations (to deactivate or reactivate the audible signals) must be carried out before starting a washing programme; the setting will remain memorised after switching off the dishwasher.

Before use

Before using your dishwasher for the first time:

1. Ensure that the electrical and water connections comply with the installation instructions
2. Remove all packaging from inside the appliance
3. Set the water softener
4. Pour 1 litre of water inside the salt container and then fill with salt
5. Fill the rinse aid dispenser.
6. Run a Rinse and Hold programme.

Setting the water softener

The dishwasher is equipped with a water softener designed to remove minerals and salts from the water supply, which would have a detrimental or adverse effect on the operation of the appliance.

The higher the content of these salts, the harder your water is. Water hardness is measured in equivalent scales, Clarke degrees, French degrees and PPM (parts per Million).

The softener should be adjusted according to the hardness of the water in your area. Your local Water Authority can advise you on the hardness of the water in your area.

The dishwasher is factory set at level 4.

If this level is not suitable for your area the softener should be adjusted.

Level	Water hardness			Use of salt
	Clarke degrees	French degrees (°TH)	PPM (Parts per Million)	
0	0 - 6	0 - 8	0 - 80	NO
1	7 - 10	9 - 14	81 - 140	YES
2	11 - 14	15 - 20	141 - 200	YES
3	15 - 21	21 - 30	201 - 300	YES
4	22 - 28	31 - 40	301 - 400	YES
5	29 - 35	41 - 50	401 - 500	YES
6	36 - 42	51 - 60	501 - 600	YES
7	43 - 49	61 - 70	601 - 700	YES
8	50 - 56	71 - 80	701 - 800	YES
9	57 - 84	81 - 120	801 - 1200	YES

If your water is level 0 it is already soft and therefore there is no need to use salt.

With the setting of the water softener at level 0 the salt indicator light on the control panel will always remain off. Use salt from level 1 upwards.

The adjustment of the water softener is possible only with the machine in setting mode.

To select a different level proceed as follows:

1. Press **SELECTION** and **DELAY** programme push buttons simultaneously for about 5 seconds. In the display appears an L followed by a number (e.g. L 4) which corresponds to the current level.

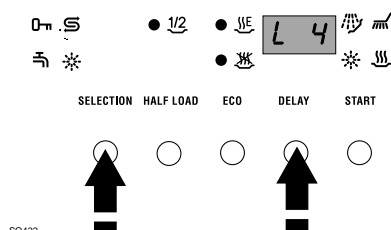

2. Press the **DELAY** push button within 5 seconds until the required level appears in the display. The level increases by 1 each time the push button is pressed.
3. 5 seconds after the **DELAY** push button has last been pressed, the dishwasher memorises the level selected and returns to the programme setting mode.

Filling with salt

Only use salt specifically designed for use in dishwashers.

All other types of salt not specifically designed for use in a dishwasher, especially table salt, will damage the water softener.

Only fill with salt just before starting one of the complete washing programmes. This will prevent any grains of salt or salty water, which may have been spilled, remaining on the bottom of the machine for any period of time, which may cause corrosion.

To fill:

1. To fill with salt, unscrew the cap of the salt container.
2. Pour 1 litre of water inside the container (**this is necessary only before filling with salt for the first time**).
3. Using the funnel provided, pour in the salt until the container is full.
Do not worry if water over flows from the unit when filling with salt, this is quite normal.

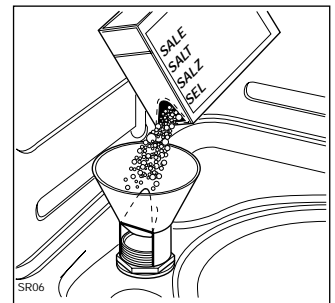

4. Replace the cap making sure that there is no trace of salt on the screw thread or on the gasket.
5. Screw on the cap tightly.

The salt container will require topping up periodically.

You are reminded of this by the salt indicator light on the control panel which comes on when the salt has finished.

The salt indicator light on the control panel can remain illuminated for 2-6 hours after the salt has been replenished, assuming the dishwasher remains switched on. If you are using salts that take longer to dissolve then this can take longer.

The operation of the machine is not affected.

Rinse aid

Rinse aid is automatically added during the last rinse, ensuring thorough rinsing, and spot and streak free drying. The dispenser, which is positioned inside the door, holds about 110 ml of rinse aid, which is sufficient for 16 - 40 dishwashing programmes, depending upon the dosage setting.

Filling with rinse aid

1. Open the container by turning the lid (A) anticlockwise.
2. Add the rinse aid until the container is completely full. The indicator (B) will be completely dark.

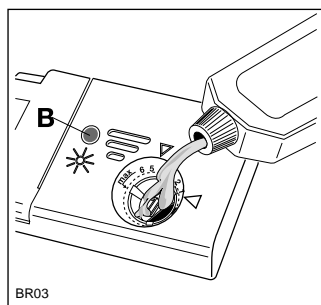
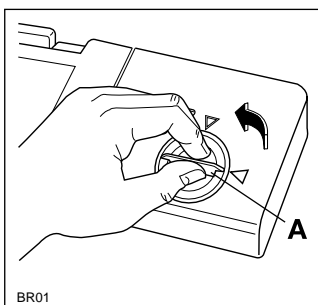

3. Top up the rinse aid when the rinse aid indicator light on the control panel illuminates.

Ensure that the lid is closed after every refill.

Do not put liquid detergent in the rinse aid compartment. Clean up any rinse aid spilt during filling with an absorbent cloth to avoid excess foaming during the next wash.

Adjusting the dose

According to the finish and drying results obtained, adjust the dose of rinse aid by means of the 6 position selector (C) (position 1 minimum dosage, position 6 maximum dosage).

Increase the dose if there are drops of water or lime spots on the dishes after washing.

Reduce it if there are sticky whitish streaks on the dishes.

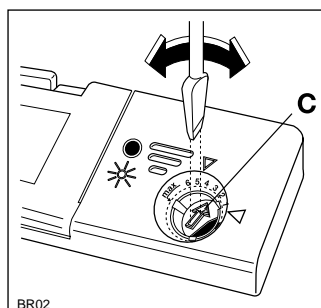

Use of detergent

Only use detergents specifically designed for use in dishwashers.

We recommend the use of **Finish detergents** which are available in the following options:

Finish Double Action Tablets. Each tablet has the exact amount of detergent required, simply place in the dispenser.

Finish Powder recommended for every day use.

Finish Liquid Gel ideal for every day use. As the gel is extra gentle it is recommended for fine bone china.

If using powder detergents proceed as follows:

1. Open the dispenser lid by pulling the catch (D).
2. Add the detergent according to the instructions given in the Washing programmes chart. As all detergents are not the same, you should also consult the instructions on the packet.
3. Always close the lid.
4. If the programme has a prewash add a little amount of detergent in the SID detergent dispenser, located in the centre of the upper basket. Follow the recommended quantity of detergent given in the Washing programmes chart.

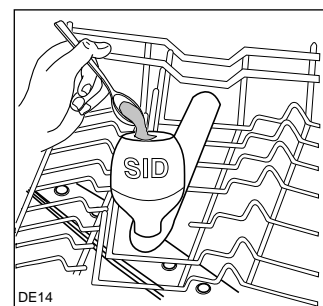
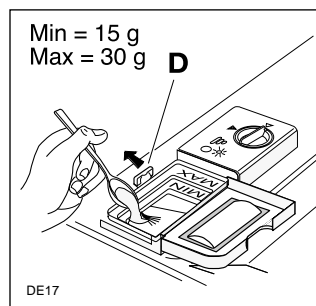

If using detergent in tablets proceed as follows:

1. For all programmes; place 1 tablet inside the detergent dispenser.
2. Always close the lid.
3. For all programmes with prewash; place a portion of a further tablet on the lid of the detergent dispenser.

Insufficient quantities of detergent will produce poor washing results, whereas an excessive amount of detergent will not improve washing results and is also wasteful.

Using no more than the correct amount also contributes to reducing pollution.

Compact detergents with enzymes

In these compact powders the environmentally unfriendly components have been replaced by natural enzymes and other more biodegradable substances.

The enzymes deploy their full dirt dissolving power at a temperature as low as 50°C.

By choosing the BIO programmes you can therefore achieve the same cleaning results that would otherwise be achievable only with 65°C programmes and conventional detergents.

Using your appliance

Loading your appliance

Before placing dishes in the machine, remove any scraps of food, to avoid clogging the filters and consequently reducing the performance.

Do not load very small items which can fall through the baskets.

Open the door and slide out the baskets to load the dishes.

The lower basket

The lower basket is designed to take saucepans, lids, plates, salad bowls, cutlery etc.

Serving dishes and large lids should be arranged around the edge of the basket, ensuring that the upper spray arm can turn freely.

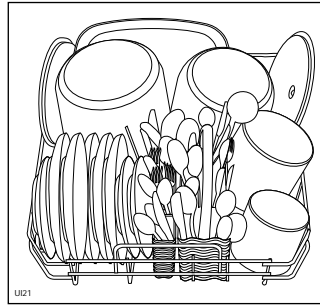
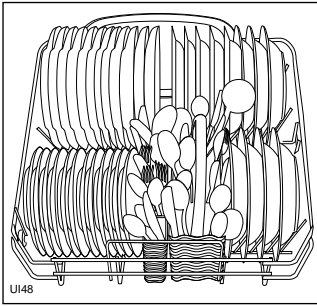

The two rear rows of prongs on the lower basket can be easily lowered to allow you to load pots, pans and bowls.

To lower the prongs:

- Slightly pull them upward and let them drop down (see picture).
- To bring them back to the standing position, just pull them up again.

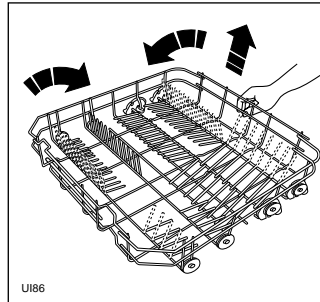

The cutlery basket

Long bladed knives stored in an upright position are a potential hazard.

These items should only be placed in the removable knife basket.

Take care when loading or unloading sharp items such as knives.

Removable knife basket

Long and/or sharp items of cutlery such as carving knives must be placed horizontally in the removable knife basket, which is positioned at the rear of the upper basket.

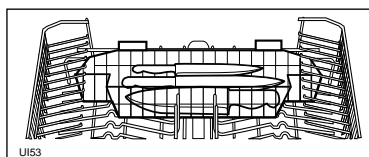

Cutlery should be placed in the removable cutlery basket with the handles facing downwards.

If the handles protrude from the bottom of the basket, obstructing the lower spray arm, load the cutlery with the handles facing upwards.

Mix spoons with other cutlery to prevent them from sticking together.

Silver cutlery tends to go black if mixed with steel cutlery. Place it in the cutlery basket separate from the others.

For best results we recommend to use the cutlery grids provided (if the size and the dimensions of the cutlery allow it).

The cutlery basket is in two parts which can be separated to give greater loading flexibility. To separate the two parts, slide them horizontally in opposite directions and pull them apart. To reassemble, reverse the procedure.

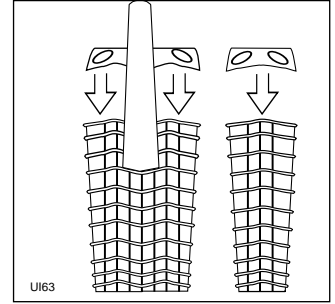
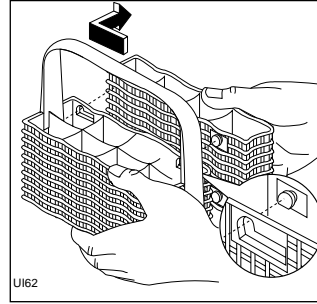

The upper basket

The upper basket is designed for plates (dessert plates, saucers, dinner plates of up to 25 cm in diameter), salad bowls, cups and glasses.

Arrange items so that water can reach all surfaces.

Glasses with long stems can be placed upside down in the cup racks.

Light items (plastic bowls etc.) should be loaded in the upper basket and arranged so they do not move.

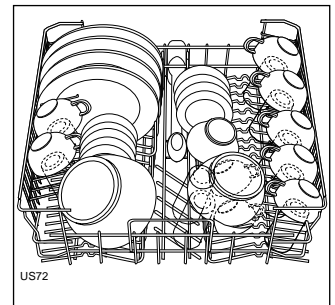

In case that plates are loaded in the upper basket:

load them starting from the rear positions of the basket, tilting them forwards and avoiding the front positions near the door.

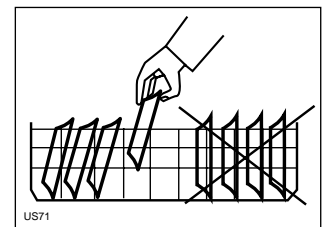

Attention!

Before closing the door, ensure that the spray arms can rotate freely.

Adjusting the height of the upper basket

If washing very large plates (over 27 cm and up to 32 cm in diameter) you can load them in the lower basket after moving the upper basket to the higher position.

Attention!

Never lift or lower the basket on one side only.

To move to the higher position proceed as follows:

1. Pull out the basket until it stops.
2. Carefully lift both sides upwards until the mechanism is engaged and the basket is stable.

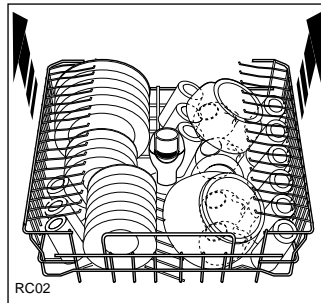

When the top basket is in the higher position it will only take plates up to 20 cm in diameter and you will not be able to use the cup racks.

To lower the basket to the original position proceed as follows:

1. Pull out the basket until it stops.
2. Carefully lift both sides upwards and allow the mechanism to drop back slowly, keeping hold of it.

Attention!

After loading your machine always close the door, as an open door can be a hazard.

Hints and tips

To save energy

Place dishes in the machine immediately after every meal and wait until the dishwasher is full before washing.

Do not prewash dishes under running water.

Select the **DAILY 30'** programme when dishes are not very soiled, following the instructions given in the "Washing programmes" chart.

Select the **HALF LOAD** option if only a few dishes need washing. Remember to load the dishes in both baskets.

For best washing results

Before loading, remove all scraps of food and soak very heavily soiled pots and pans.

Arrange saucepans, cups and glasses etc. upside-down.

Tilt items with convex or concave surfaces so that the water drains off easily.

Avoid contact between the dishes as far as possible.

Items not suitable for dishwashers

The following items should not be washed in the dishwasher (unless they are sold as dishwasher proof):

- Cutlery with wooden or horn handles or glued parts
- bronze cutlery
- saucepans with wooden handles
- aluminium ware
- crystal ware
- leaded glass
- plastic items
- antique or fine decorated china

Certain types of decoration can discolour when washed in a dishwasher.

Crystal-ware and plastic objects, if not guaranteed dishwasher proof should be washed by hand.

Certain types of glass can also become opaque after being washed several times in a dishwasher.

A chemical reaction can occur between silver cutlery and stainless steel cutlery. As a precaution, do not wash together.

Iron and cast iron objects can rust and stain other items.

Aluminium tends to go black, copper, pewter and brass tend to stain.

**If in doubt check with manufacturer of the item.
When buying new dishes, ensure that they are dishwasher proof.**

For best results we recommend the use of Finish detergents, rinse aid and salt.



Washing programmes

Programme	Type of load and degree of soil	Recommended quantity of detergent		Cycle description
		wash	prewash	
1. Rinse and Hold	Any. Partial load (to be completed later in the day)	/	/	1 cold rinse (to avoid food scraps from sticking together)
2. Intensive 70°C	Heavy soil. Crockery, cutlery, pots and pans	20 g	10 g	Hot prewash Main wash up to 70°C 3 cold rinses 1 hot rinse Turbo dry
3. Normal Plus 65°C with prewash	Normal soil. Crockery, cutlery, pots and pans	20 g	10 g	Hot prewash Main wash up to 65°C 2 warm rinses 1 hot rinse Turbo dry
* 4. Intensive 80'	Normal soil. Crockery and cutlery	20 g	10 g	Hot prewash Main wash up to 70°C 1 cold rinse 1 hot rinse Turbo dry
5. Normal 65°C no prewash	Light soil. Crockery and cutlery	30 g	/	Main wash up to 65°C 2 cold rinses 1 hot rinse Turbo dry
** 6. Bio 50°C with prewash	Normal soil. Crockery and cutlery	20 g	10 g	Warm prewash Main wash up to 50°C 2 cold rinses 1 hot rinse Turbo dry
7. Bio 50°C no prewash	Light soil. Crockery and cutlery	30 g	/	Main wash up to 50°C 2 cold rinses 1 hot rinse Turbo dry
*** 8. Quick Wash 50°C	Light soil. Crockery, cutlery and party crockery	30 g	/	Main wash up to 50°C 1 cold rinse 1 hot rinse
9. Delicate 45°C with prewash	Normal soil. Delicate china and crockery	25 g	5 g	Cold prewash Main wash up to 45°C 2 cold rinses 1 hot rinse Turbo dry
10. Crystal 40°C	Light soil. Crystal glass and delicate glassware	25 g	5 g	Cold prewash Main wash up to 40°C 2 cold rinses 1 hot rinse Turbo dry
**** 11. Quick 30'	Fresh soil. Crockery and cutlery	20 g	/	Main wash up to 60°C 1 hot rinse
12. Plate Warmer	This is a programme both designed to heat plates before serving or remove dust from dishes which have not been used for a long time	/	/	1 hot rinse

* Ideal for washing a complete load of **12 place settings with normal soil**.

Characterised by a duration of about 80 minutes and a washing temperature of 70°C. The time value is approximated and depends on the pressure and the temperature of the water and also by the variations of the power supply.

** Testing programme for EN 50242 (see "Hints for Test Centres"). This programme, developed for the use of detergents with enzymes, allows to achieve, with reduced consumption of energy the same cleaning results that would otherwise be obtained only with the 65°C programmes and conventional detergents. To compensate the lower temperature, the duration of the programme has been prolonged.

*** This is a special programme for quick washing a full load of lightly soiled dishes, glasses and crockery (except pots) so that you may re-use them promptly

**** Ideal for washing crockery and cutlery of breakfast and dinner (**fresh soil**).

Characterised by a duration of about 30 minutes and a washing temperature of 60°C. The time value is approximated and depends on the pressure and the temperature of the water and also by the variations of the power supply.

This is the a daily programme, made to meet the needs of a family of **4 persons** who only wish to load breakfast and dinner crockery and cutlery.

Operating sequence

1. Check the filters

Ensure they are clean and properly positioned (see "Maintenance and cleaning").

2. Press the On/Off push button

The display will show the last selected programme and the corresponding phase indicator lights will illuminate. If the door is open also the "open door" indicator light will illuminate.

3. Check that there is rinse aid and salt

The corresponding indicator lights will illuminate if refilling is necessary.

4. Load the dishes

Remove any scraps of food.

Pull the lower basket out and arrange the saucepans, plates and cutlery in it.

Pull the upper basket out and arrange the plates, saucers, glasses and cups etc. in it.

Slide the baskets back into the machine.

5. Ensure that the spray arms can rotate freely

6. Measure out detergent

Add the required amount of detergent into the dispenser.

Important!

If you select the half load option remember to reduce the quantity of detergent.

Close the detergent dispenser lid.

7. The setting of the programme can be done both with opened or closed door

Opened door: select the programme and if necessary the options (drying options, half load, delay start).

The **START** push button can be pressed before the closure of the door (in this case the phase indicator lights for that programme will turn off, except for the indicator light of the first phase of the programme that will flash continuously until the closure of the door).

Close the door and the programme will start automatically.

Opened door: select the programme and if necessary the options (drying options, half load, delay start).

Close the door and press the **START** push button, the programme will start automatically.

Closed door: select the programme and if necessary the options (drying options, half load, delay start).

The start of the programme will only occur only after having pressed the **START** push button.

8a. Setting and starting the programme without "delay start"

Press the "**SELECTION**" push button until the required programme number appears in the digital display.

Select a drying option and/or half load (if desired).

Press the **START** push button, an audible signal advises you that the programme has started.

The display will show the running time of the programme and the indicator lights of the phases will turn off except for the indicator light of the current phase.

The time in the digital display will start to decrease from minute to minute.

Pressing the "**SELECTION**" push button while the programme is running will display the number of the current programme.

If the door is opened during the run of the programme the current phase will be interrupted and the digital display will show the number of the programme. The indicator light of the interrupted phase will start to flash and the indicator light "open door" will illuminate.

Once the door is closed the programme will start from the point where it was interrupted.

8b. Setting and starting the programme with "delay start"

Once a programme and required options (see point 8a) have been selected to use **DELAY** proceed as follows:

Press the **DELAY** push button. The digital display will show "h 0". Press the button again to select the number of hours by which you wish to delay the programme start (up to a maximum of 12 hours).

The delay start will not modify the settings made previously .

To set the time setting to zero press the **DELAY** push button until "h 0" appears in the digital display.

Press the **START** push button.

The digital display shows the delay time required before the start of the programme that will decrease from hour in hour.

The start of the countdown will be confirmed by the flashing "h" in the digital display.

The phase indicator lights will turn off, only the indicator lights of the options (drying and/or half load), if selected, will remain on.

Once the delayed time has elapsed the programme will start automatically.

If you desire to cancel a delay start in progress follow the instructions given in the following chapter (point 9).

9. To cancel a programme in progress

Press the **"START"** push button for 5 seconds to cancel the setting or the running of the current programme. An intermittent audible signal will be heard and all the indicator lights will turn off while in the digital display 3 horizontal lines will appear.

After 5 seconds the dishwasher will return to setting mode.

It is now possible to select a new washing programme.

10. At the end of the washing programme

The dishwasher will automatically stop and an intermittent audible signal will be heard when the programme has ended.

3 flashing horizontal lines will appear in the digital display and all the indicator lights (drying phase included) will turn off.

If the end of the programme has not occurred it will not be possible to select a new one if the previous programme has not been cancelled (see point 9).

Press the On/Off push button and open the door and wait a few minutes before removing the dishes; in this way they will be cooler and the drying will be improved.

Empty the lower basket first and then the upper one; this will avoid water dripping from the upper basket onto the dishes in the lower one.

Important!

In general it is not advisable to open the door while the machine is working; if the door is opened however, a safety device ensures that the machine stops.

Care must be taken if the door is opened during the hot phase or immediately after a programme has finished, as steam may escape.

When the washing programme has finished, it is recommended that the dishwasher is unplugged and the water tap turned off.

Maintenance and cleaning

Internal cleaning

Ensure that the seals around the door, the detergent and rinse aid dispensers are cleaned regularly with a damp cloth.

We recommend the use of **Finish Dishwasher Cleaner** every 3 months or run a 65°C wash without dishes using detergent. Regular use of Finish Dishwasher Cleaner cleans inaccessible parts, eliminates unpleasant food odours and helps prevent the build-up of limescale.

Cleaning the central filter

(After each wash)

Scraps of food may accumulate in the drain filter (A) and should be removed by rinsing the filter under running water.

To remove the drain filter

- simply pull it out by the handle.

Once cleaned, refit the filter by pushing it back to its original position until it engages.

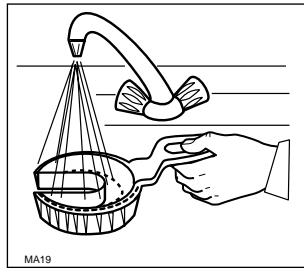
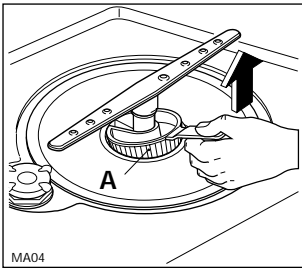

Cleaning the large filter

(Every week)

If necessary clean the large filter (B) on both sides under running water, using a brush.

To remove the large filter

1. Remove the spray arm by pulling it upwards on one side.
2. Turn the column (C) anticlockwise by 90° and then slide out the filter.
3. Once cleaned refit it following the above instructions in reverse order.
4. Ensure the filter is in its original position, the handle of the drain filter should be pointing towards the front of the appliance.

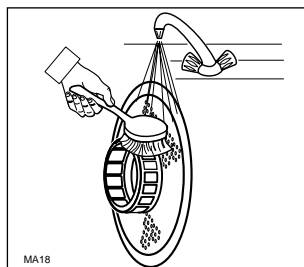
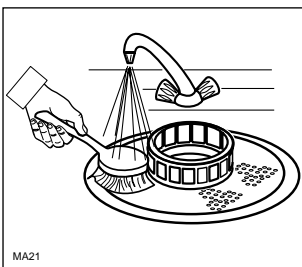
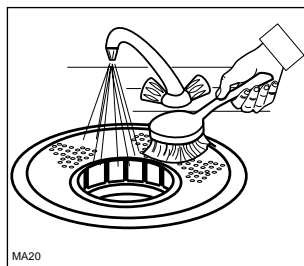
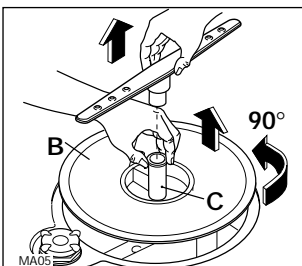

The dishwasher must not be used without filters. Incorrect repositioning and fitting of the filters will produce poor washing results. Cleaning the filters is vital to ensure correct operation of the machine.

Check that the SID is not clogged with detergent residue. If necessary rinse it under running water after having removed it from the basket by twisting it anticlockwise and pulling it upwards.

Fasten it back onto the support by turning it clockwise.

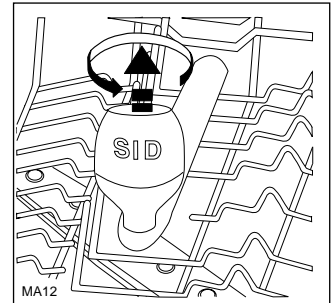

Never use your dishwasher without the SID dispenser. Since SID also ensures correct distribution of the water to the upper spray arm, running the dishwasher without it will impair the washing results.

External cleaning

Clean the external surfaces of the machine and control panel with a damp soft cloth. If necessary use only neutral detergents. Never use abrasive products, scouring pads or solvent (acetone, trichloroethylene etc....).

Prolonged periods of non-operation

If you are not using the machine for any period of time you are advised to:

1. Unplug the appliance and then turn off the water.
2. Fill the rinse aid dispenser.
3. Leave the door ajar to prevent the formation of any unpleasant smells.
4. Leave the inside of the machine clean.

Frost precautions

Avoid placing the machine in a location where the temperature is below 0°C. If this is unavoidable, empty the machine, close the appliance door, disconnect the water inlet pipe and empty it.

Moving the machine

If you have to move the machine (moving house etc....):

1. Unplug it.
 2. Turn the water tap off.
 3. Remove the water inlet and discharge hoses.
 4. Pull the machine out together with the hoses.
- Avoid over tilting the machine during transportation.

Something not working

Certain problems are due to lack of simple maintenance or oversights, which can be solved easily without calling out an engineer. The dishwasher is fitted with a number of alarm systems which can help you to quickly determine the cause of any problems. If the dishwasher will not start or stops during operation, all push buttons are inoperative except for the On/Off push button, all the indicator lights turn off and in the digital display one of the following flashing fault codes will appear: AL1, AL2, AL3, AL4, AL5, AL6, AL7, AL8.

Press the On/Off push button to switch off the dishwasher and carry out the following suggested corrective actions listed below. Once the checks have been carried out switch on the dishwasher and start a washing programme, if the fault code reappears in the digital display, contact your local Service Force Centre.

Important: If you call out an engineer to a fault listed below or to repair a fault caused by incorrect use or installation a charge will be made, even if the appliance is in guarantee.

Symptom	Fault code	Solution
The machine will not start		<ul style="list-style-type: none"> The door has not been properly closed. Indicator light "open door" illuminates. The plug is not properly inserted in the power socket. There is a power failure.
The machine does not fill with water	Indicator light "water tap" flashes and/or alarm AL5	<ul style="list-style-type: none"> Ensure the water tap is open. Ensure the mains water supply has not been cut off. The inlet hose may be squashed or bent. Reposition the hose. The inlet hose may be blocked. Switch off the water supply and clean the filter.
The dishwasher will not drain	Alarm AL6	<ul style="list-style-type: none"> The drain hose may be squashed or bent. Reposition the hose. The sink may be blocked. Clear any blockages. The drain hose extension is not correct. Follow the instructions for connecting to the waste. There is no vent in the end of the drain hose.
Protection against flooding is active	Alarm AL4	<ul style="list-style-type: none"> Close the water tap and contact the Service Force Centre.
General	Alarms AL1, AL2, AL3, AL7, AL8	<ul style="list-style-type: none"> Switch off the dishwasher. Switch it back on and start the programme. If the alarm reappears, call the local Service Force Centre.
The machine is noisy		<ul style="list-style-type: none"> Dishes are rattling against each other, refer to "Loading your machine". The spray arms are knocking against the dishes. Refer to "Loading your machine".
The door is difficult to close		<ul style="list-style-type: none"> The dishwasher is not level, or not properly built-in.
Visible lime deposits or white film on the dishes		<ul style="list-style-type: none"> Check that there is salt and that the salt cap is tight. Check that the right level of the water softener is setted.
The dishes are not quite dry		<ul style="list-style-type: none"> The rinse aid has run out or too little is being used.
The dishes are not clean (poor wash)		<ul style="list-style-type: none"> The baskets are too full. The dishes have not been arranged properly. The spray arms do not rotate The spray arms are clogged. The filters are clogged. The filters are not in the correct position. Not enough detergent has been used or it is unsuitable. The detergent is old or has gone hard. The salt container cap is not properly closed. The washing programme selected is too gentle.

If after all these checks, the problem persists, contact your local Service Force Centre, quoting the model and serial number. This information can be found on the rating plate located on the right hand side of the dishwasher door (see picture).

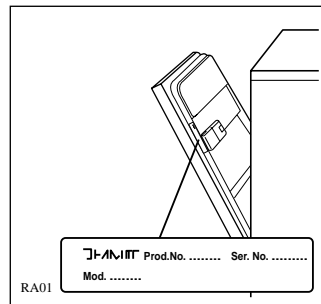

Protection against flooding

The machine is fitted with a device in the bottom of the machine to protect against flooding. The device will operate if there are any water leaks in the machine, however it will only operate if the machine is on.

In case of intervention the digital display will show "AL4". Turn off the water tap and call the Service Force Centre.

Service and Spare Parts

In the event of your appliance requiring service, or if you wish to purchase spare parts please contact your local Service Force Centre by telephoning:

08705 929929

Your telephone call will be automatically routed to the Service Force centre covering your post code area.

For the address of your local Service Force Centre and further information about Service Force, please visit the website at www.serviceforce.co.uk

Before calling out an engineer, please ensure you read the details under the heading Something not working.

When you contact the Service Force Centre you will need to give the following details:

1. Your name, address and post code
2. Your telephone number
3. Clear and concise details of the fault
4. The model and serial number (found on the rating plate)
5. The purchase date

Please note that a valid purchase receipt or guarantee documentation is required for in-guarantee service calls.

Customer Care Department

For general enquiries concerning your Zanussi appliance or for further information on Zanussi products please contact our Customer Care Department by letter or telephone at the address below or visit our website at www.zanussi.co.uk

Customer Care Department
Zanussi
55-77 High Street
Slough
Berkshire
SL1 1DZ
Tel: 08705 727727 (*)

** calls to this number may be recorded for training purposes*

Guarantee Conditions

Standard guarantee conditions

We, Zanussi, undertake that if within 24 months of the date of purchase this Zanussi appliance or any part thereof is proved to be defective by reason only of faulty workmanship or materials, we will, at our option repair or replace the same FREE OF CHARGE for labour, materials or carriage on condition that:

- The appliance has been correctly installed and used only on the electricity supply stated on the rating plate.
- The appliance has been used for normal domestic purposes only, and in accordance with the manufacturer's instructions.
- The appliance has not been serviced, maintained repaired, taken apart or tampered with by any person not authorised by us.
- All service work under this guarantee must be undertaken by a Zanussi Service Force Centre.
- Any appliance or defective part replaced shall become the Company's property.
- This guarantee is in addition to your statutory and other legal rights.

Home visits are made between **8.30am** and **5.30pm** Monday to Friday. Visits may be available outside these hours in which case a premium will be charged.

Exclusions

This guarantee does not cover:

- Damage or calls resulting from transportation, improper use or neglect, the replacement of any light bulbs or removable parts of glass or plastic.
- Costs incurred for calls to put right an appliance which is improperly installed or calls to appliances outside the United Kingdom.
- Appliances found to be in use within a commercial environment, plus those which are subject to rental agreements.
- Products of Zanussi manufacture which are not marketed by Zanussi.

European Guarantee

If you should move to another country within Europe then your guarantee moves with you to your new home subject to the following qualifications:

- The guarantee starts from the date you first purchased your product.
- The guarantee is for the same period and to the same extent for labour and parts as exists in the new country of use for this brand or range of products.
- This guarantee relates to you and cannot be transferred to another user.
- Your new home is within the European Community (EC) or European free Trade Area.
- The product is installed and used in accordance with our instructions and is only used domestically, i.e. a normal household.
- The product is installed taking into account regulations in your new country.

Before you move please contact your nearest Customer Care centre, listed below, to give them details of your new home. They will then ensure that the local service Organisation is aware of your move and able to look after you and your appliances.

France	Senlis	+33 (0) 3 44 62 29 29
Germany	Nurnberg	+49 (0) 800 234 7378
Italy	Pordenone	+39 (0) 434 39 4700
Sweden	Stockholm	+46 (0) 8 672 53 90
UK	Slough	+44 (0) 1753 219897
Ireland	Dublin	+353 (0) 14090753

Hints for test centres

Before starting any test it is necessary to fill completely with salt the salt container and with rinse aid the rinse aid dispenser.

Test standard	EN 50242
Reference programme:	Programme 6 - Bio 50°C with prewash
Load:	12 standard place settings
Rinse aid selector:	position 5
Detergent dosage :	20 g in the dispenser 10 g on the dispenser lid



Arrangement upper basket

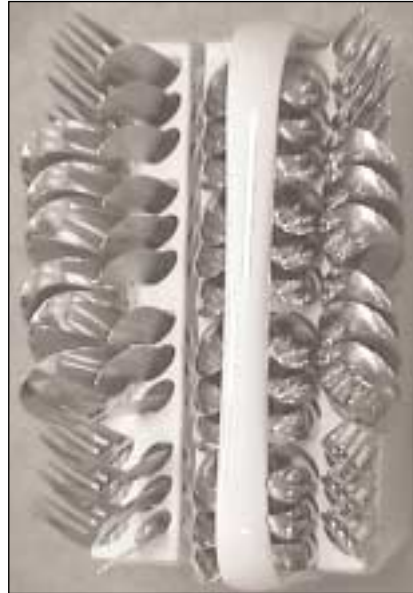

Arrangement cutlery basket



Arrangement lower basket

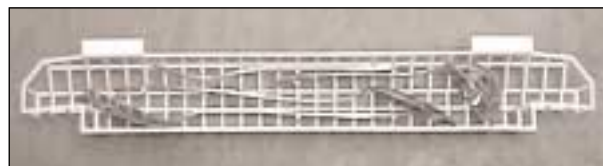

Arrangement knife basket

Installation instructions

Any electrical work required to install this appliance should be carried out by a qualified electrician or competent person.

Any plumbing work required to install this appliance should be carried out by a qualified plumber or competent person.

Remove all packaging before positioning the machine.

If possible, position the machine next to a water tap and a drain.

Water supply connections

This dishwasher must be plumbed into a cold water supply. The water pressure must be within the limits given in the technical specifications (page 2).

Your local Water Authority will advise you on the average mains pressure in your area.

The dishwasher features fill and drain hoses which can be turned either to the left or the right to suit the installation.

Do not use, for the connection, old hoses which have been used in another appliance.

The locknut must be correctly fitted to avoid water leaks.

Avoid bends or kinks in the hose which could prevent or slow down the water supply.

If the machine is connected to new pipes or pipes which have not been used for a long time, you should run the water for a few minutes before connecting the inlet hose. This will prevent deposits of sand or rust clogging the inlet hose filter.

Water outlet hose connection

The end of the drain hose can be connected in the following ways:

1. To the sink outlet spigot, securing it if necessary with a clip.
2. To a stand pipe provided with vent-hole, minimum internal diameter 4 cm.

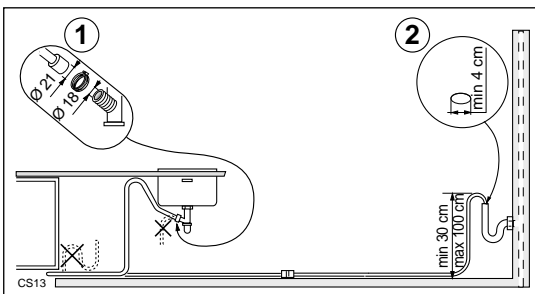

The waste connection must be at a height of between 30 cm (minimum) and 100 cm (maximum) from the bottom of the dishwasher.

The drain hose can face either to the right or left of the dishwasher

Ensure the hose is not bent or squashed as this could prevent or slow down the discharge of water.

The sink plug must not be in place when the machine is draining as this could cause the water to siphon back into the machine.

Attention!

Our appliances are supplied with a security device to protect against the return of dirty water back into the machine.

If the spigot of your sink has a "no return valve" incorporated this can prevent the correct draining of your dishwasher.

We advise you therefore to remove it.

If you use a drain hose extension it must be no longer than 2 metres and its internal diameter must be no smaller than the diameter of the hose provided.

Likewise the internal diameter of the couplings used for connections to the waste outlet must be no smaller than the diameter of the hose provided.

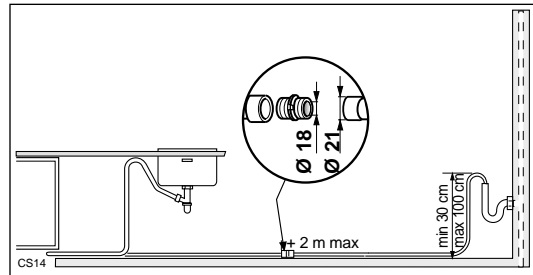

Electrical connection

This appliance must be earthed.

The manufacturer declines any responsibility should this safety measure not be observed.

If the plug that is fitted to your appliance is not suitable for the socket, it must be cut off and the appropriate plug fitted.

Important

The wires on the mains lead are coloured in accordance with the following code:

Green and Yellow - Earth

Blue - Neutral

Brown - Live

If you fit your own plug, the colours of the wires in the mains lead of your appliance may not correspond with the markings identifying the terminals in your plug.

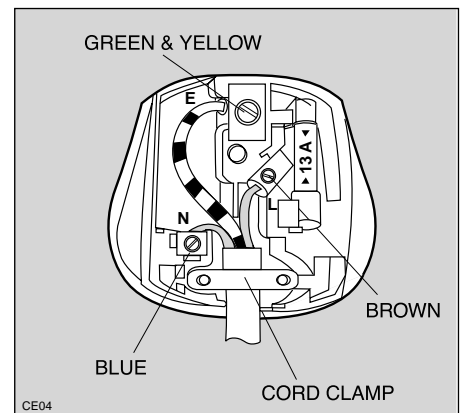

Proceed as follows:

1. Connect the Green and Yellow (earth) wire to the terminal in the plug which is marked with the letter "E" or the earth symbol \oplus or coloured green and yellow.
2. Connect the Blue (neutral) wire to the terminal in the plug which is marked with the letter "N" or coloured black.
3. Connect the Brown (live) wire to the terminal in the plug which is marked with the letter "L" or coloured red.

The plug moulded onto the lead incorporates a 13amp BSI362 fuse. Only ASTA or BSI fuses should be used.

The plug must not be used if the fuse cover/carrier is lost. The cover/carrier is indicated by the coloured insert at the base of the plug.

A replacement cover/carrier must be obtained from your local Service Force Centre.

 **From the Electrolux Group. The world's No.1 choice.**

The Electrolux Group is the world's largest producer of powered appliances for kitchen, cleaning and outdoor use. More than 55 million Electrolux Group products (such as refrigerators, cookers, vacuum cleaners, chain saws and lawn mowers) are sold each year to a value of approx. 14 billion USD in more than 150 countries around the world.