

use & care guide

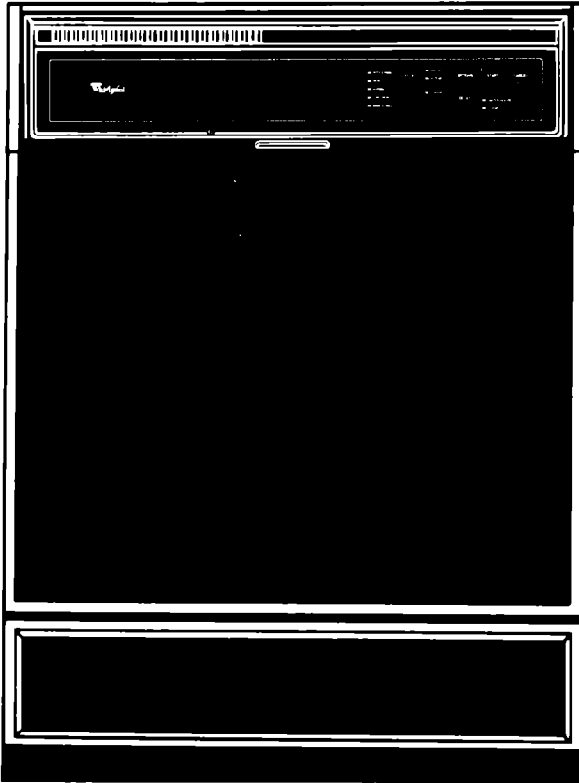

UNDERCOUNTER DISHWASHER

Model DU9200XT Series

rs. Ice Makers. Dishwashers. Built In Ovens and Surface Units. Ranges. Microwave Ovens. Trash Compactors. Room Air Conditioners. Dehumidifiers. Automatic Washers. Clothes Dryers. Freezers. Ri



3367701

Contents

	Page		Page
BEFORE YOU USE YOUR DISHWASHER	2	RINSE AID DISPENSER	7
IMPORTANT SAFETY INSTRUCTIONS	2	STARTING YOUR DISHWASHER	8
PARTS AND FEATURES	3	Selecting a Cycle	8
QUICK STARTING STEPS	4	Selecting an Option	9
POWER CLEAN* WASHING SYSTEM	4	Selecting an Extra Feature	11
Quiet Operating Tips	4	ENERGY SAVING TIPS	13
PROPER LOADING	5	SPECIAL TIPS	14
Top Rack Loading	5	COMMON DISHWASHING PROBLEMS	15
Bottom Rack Loading	6	IF YOU NEED SERVICE OR ASSISTANCE	17
Silverware Basket Loading	6	WHIRLPOOL DISHWASHER WARRANTY	20
ADDING DETERGENT	7		

*Tmk.

©1988 Whirlpool Corporation

Before you use your dishwasher



It is your personal responsibility and obligation to be sure your dishwasher:

- Is installed by a qualified installer.
- Has been installed where it is protected from the elements.
- Has been installed on a floor strong enough to support its weight.
- Has been properly connected to electricity, water and drain.*
- Has been properly electrically grounded.*
- Has had all hang tags and temporary labels removed.
- Is not used by children or anyone unable to operate it properly.
- Is properly maintained.

*See installation instructions for complete information.

Important safety instructions



WARNING – When using your dishwasher, follow basic precautions, including the following:

1. **Read all instructions before using the dishwasher.**
2. **DO NOT** let children play in or on the dishwasher.
3. **DO NOT** reach into the area below the bottom rack until the Heating Element has cooled for at least 20 minutes.
4. **DO NOT** wash plastic items unless marked "Dishwasher Safe" or the equivalent. If not marked check manufacturer's recommendations.
5. Store dishwasher detergent in a cool, dry place **WHERE CHILDREN CAN'T REACH IT.**
6. Use **ONLY** detergents and rinse aids recommended for use in a dishwasher.
7. **REMEMBER**, use your dishwasher only for the job it was designed to do.
8. Locate sharp items and knives so that they are not likely to damage door seal or cut the user.
9. Properly connect to electricity and water.
10. **DISHWASHER MUST BE ELECTRICALLY GROUNDED.** Read the Installation Instructions for details.
11. **DO NOT** use your dishwasher unless all enclosure panels are properly in place.
12. Be sure your dishwasher is installed on a level floor that will hold the weight, and in an area suitable for its size and use.
13. **DO NOT** sit, stand on or abuse the dishwasher door or dish racks.
14. **DO NOT** tamper with controls.
15. When discarding an old dishwasher, always remove the door to prevent accidental entrapment.
16. **WARNING: If hot water has not been used recently (usually two weeks or longer), hydrogen gases may build up in the water heater and the hot water pipes. HYDROGEN GAS IS EXPLOSIVE. To prevent injury or damage, before using your dishwasher, turn on all hot water faucets and allow water to run for several minutes. This will allow gases to escape. Do not smoke or use any open flame near the faucet while it is open.**
17. **WARNING: Disconnect electrical power to the dishwasher before attempting to service.**

– SAVE THESE INSTRUCTIONS –

Parts and features

Model DU9200XT Series

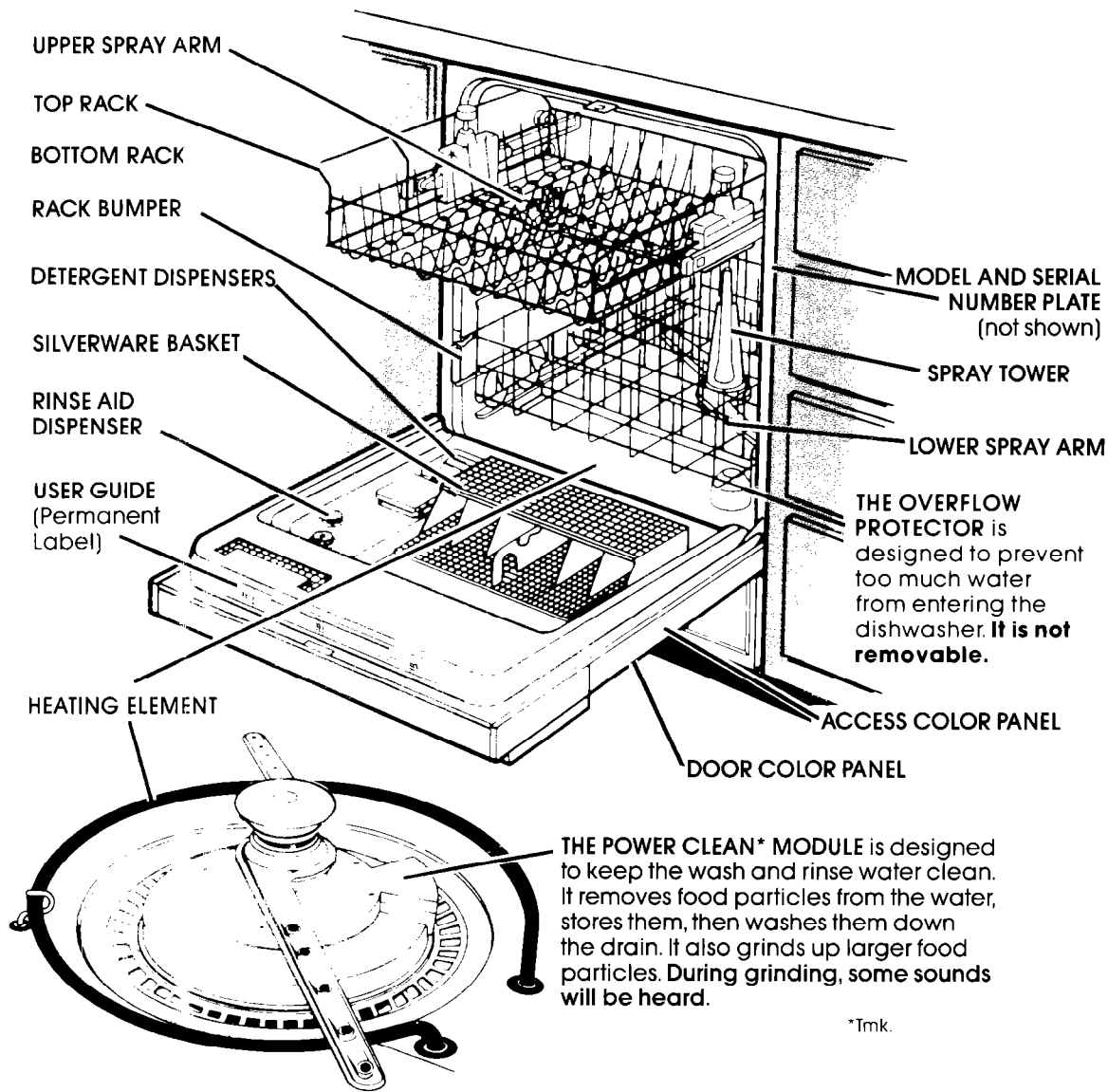

BEFORE YOU USE • SAFETY • PARTS AND FEATURES

Thank you for buying a Whirlpool appliance. Please complete and mail the Owner Registration Card provided with this product. Then complete the form below. Have this information ready if you need service or call with a question.

- Copy Model and Serial Numbers from plate (see diagram above) and purchase date from sales slip.
- Keep this book and sales slip together in a handy place.

Model Number

Serial Number

Purchase Date

Service Company Phone Number

Quick Starting Steps

1. Properly load the top and bottom racks, and silverware basket.
2. Spin the Upper and Lower Spray Arms to make sure nothing will stop them from turning freely.
3. Add detergent.
4. Check rinse aid dispenser.
5. Close and latch door.
6. Run hot water at sink nearest dishwasher until it is hot. Turn it off.
7. Select a cycle.
8. Select an option.
9. Press START.

POWER CLEAN* Washing System

Your dishwasher cleans by spraying a mixture of hot, clean water and detergent against soiled surfaces of dishes. When a cycle is started, the dishwasher fills with water to about the level of the heating element. This water is pumped through the rotating spray arms, through the POWER CLEAN* Module which removes food particles, and back through the rotating spray arms. Soiled water is pumped out and replaced with clean water during a cycle – the number of times depends on the cycle being used.

Load dishes so soiled surfaces face powerful spray from rotating arms.

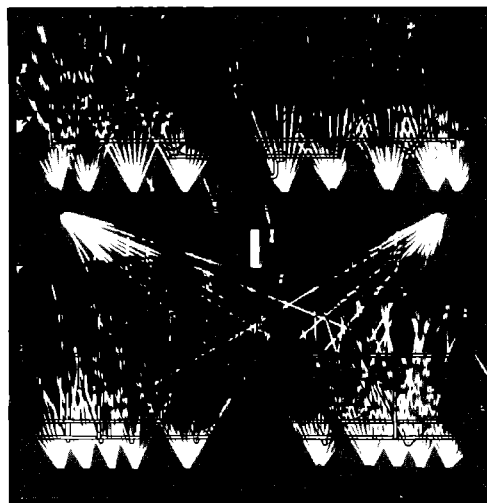

Step-saving preparation for washing

It is not necessary to rinse dishes before putting them into the dishwasher. Just remove large pieces, bones, and other hard items. The POWER CLEAN* Module will remove food particles from the water. It contains a chopping device which will reduce the size of food items.

If hard items such as fruit seeds, nuts and egg shells enter the POWER CLEAN* Module, you

might hear chopping, grinding, crunching or buzzing sounds. Those sounds are normal when hard items enter the module. **DO NOT LET METALLIC ITEMS (I.E. POT HANDLE SCREWS) GET INTO THE POWER CLEAN* MODULE. THIS COULD RESULT IN DAMAGE TO THE POWER CLEAN* MODULE.**

Hot water is a must

Hot water dissolves and activates the dishwashing detergent. Hot water dissolves grease on dishes and helps dry glasses spot-free. Make certain loads are washed in hot water (at least 140°F – 60°C). Two ways to have a reliable hot water supply...

1. Maintain 140°F water supply at central water heater. To check water temperature, turn on hot water faucet nearest the dishwasher. Let water run until it is as hot as possible, then check with a candy or meat thermometer. If

the temperature is too low, have a qualified person raise the water heater thermostat setting.

2. Use HI-TEMP WASHING Option. If water heating is needed, a thermostat will delay the cycle until temperature reaches 145°F (63°C). If water is hot enough, the cycle will proceed with no delay. This lets you turn down your water heater, if you choose, without cutting back on hot water needed for good dishwashing.

Quiet operating tips

To avoid thumping and clattering noises during operation:

- Make sure lightweight load items are secured in the rack.
- Make sure pot lids and handles, pizza pans, cookie sheets, etc. do not touch interior walls

or interfere with either of the spray arms rotation.

- Load dishes so they **don't** touch one another.
- NOTE: Keep sink drain plugs inserted during dishwasher operation to prevent noise transfer through drains.**

*Tmk.

Proper loading

Always load dishes so soiled surfaces are reached by spray from rotating spray arms. Water must be able to drain off completely for best drying results. Be careful to separate items so spray can reach all surfaces.

Top rack loading

CUP AND GLASS LOAD

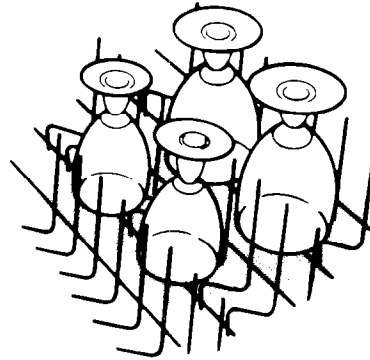
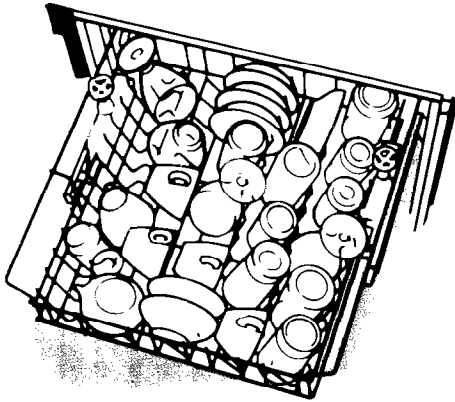

The top rack is designed for cups, glasses and smaller items.

- Place so open ends face down for cleaning and draining.
- **Load glasses in top rack only.** Bottom rack is not designed for glasses. Damage may occur.

- Place items in the rows **between** prongs. Placing them **over** the prongs can lead to breakage.
- Be sure lightweight items are held firmly in place.
- China, crystal and other delicate items must not touch each other during dishwasher operation. Damage may occur.

MIXED LOAD

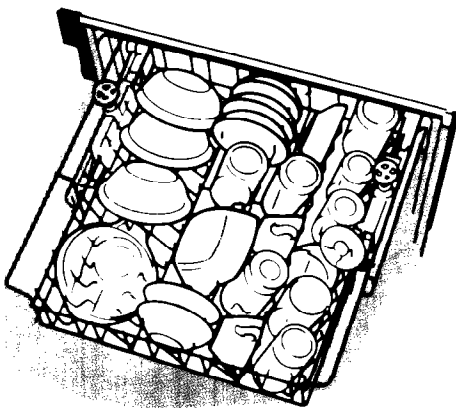

ADJUSTABLE TOP RACK

The top rack does not have to be level.

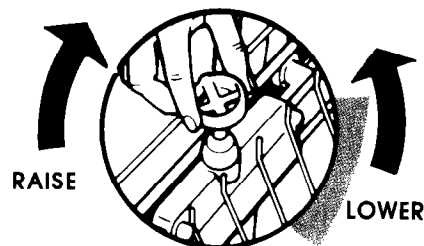

- Load plastic items **in the top rack only.** Only plastic items marked "dishwasher safe" are recommended.
- Plastic items can be melted in the bottom rack.
- Small bowls, pans and other utensils can be placed in the top rack.
- Items with cooked-on or dried-on foods should be loaded in the bottom rack with soiled surfaces facing the spray.
- Raise or lower one or both sides to help fit tall items in the top or bottom rack.
- Turn knob clockwise to raise a side.
- Turn knob counterclockwise to lower a side.

Bottom rack loading

MIXED LOAD

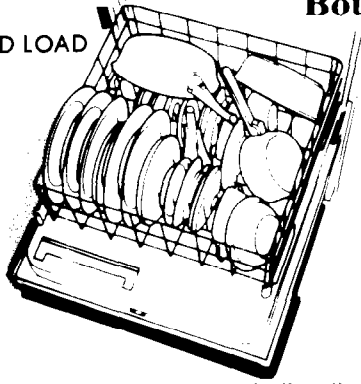

- Make sure pot handles and other items do not stop rotation of either the upper or lower spray arm. Spray arms must move freely.
- Load items so they do not block or cover spray tower.
- Securely place heavily soiled cookware face down in rack.

DISH LOAD

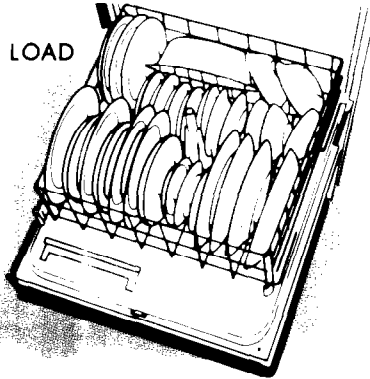

- Place plates, soup bowls, etc., **between** prongs and facing the spray.

UTENSIL LOAD

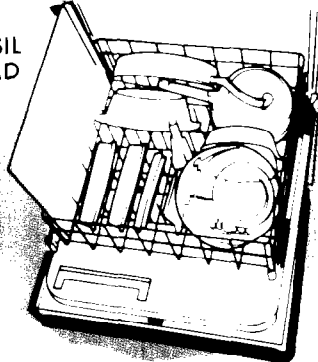

- Load cookie sheets, cake pans and other large items at sides or back. Loading such items in front may keep water spray from reaching detergent dispenser and silverware basket.

NOTE:

- Do not load glasses, cups or plastic items in the bottom rack.
- When lower rack is removed, replace with bumpers in front.

Silverware basket loading

Load forks and spoons so they **don't nest together**. Spray can't reach nested items.

NO



YES



Mix items in each section of the basket. Small items – baby bottle caps, jar lids, etc. – can be put in any section.

Make sure sharp items (knives, forks, skewers, etc.) are put in point down.

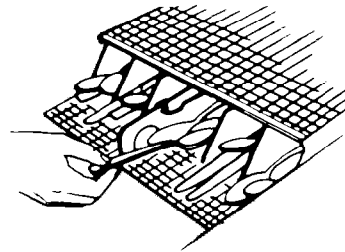

The silverware basket can be loaded while it's in place on the door, or it can be taken out for loading on the counter or table.

It can also be removed for easy unloading. Always unload or remove the basket before unloading the racks to avoid spilling water droplets on the silverware.

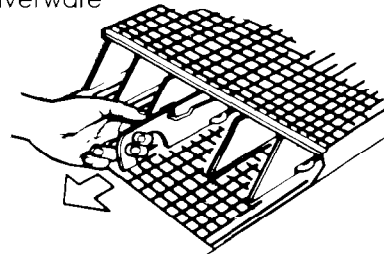

To remove the basket, slide it toward the top of the door – by the handle. Lift it off the holding buttons. Replace it in reverse order.

To open the basket, unhook the latch as shown. Be sure the cover is completely latched before pulling out the bottom rack and before closing the dishwasher door.

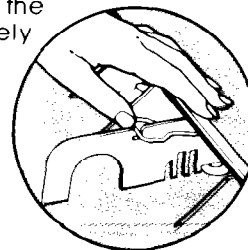

Adding detergent

The kind and amount of dishwasher detergent you use is an important part of getting your dishes clean. Read this section carefully.

Use automatic dishwasher detergent only.

Other detergents are too mild and much too sudsy to work in the dishwasher.

Different brands of dishwasher detergent have different amounts of phosphorus. Phosphorus softens water and helps prevent water spots on dishes.

If water is hard and phosphorus content is low (6.0% or less), you may need to use more detergent or use a brand with a higher phosphorus content (8.7% or higher).

Do not add detergent until you are ready to wash. When using Delay Wash, make sure the detergent dispensers are clean and dry before adding the detergent. **Fresh automatic dishwasher detergent is necessary for best washing results.** Store detergent tightly closed in a cool dry place.

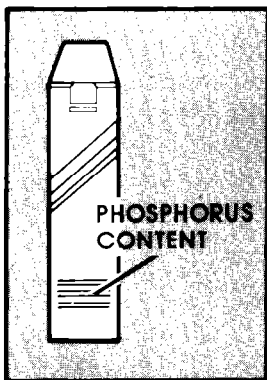
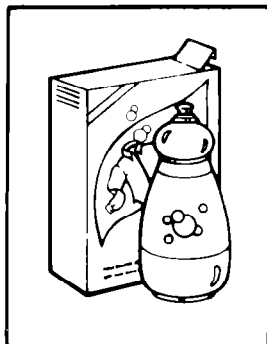

The detergent dispenser

The detergent dispenser has one section with a cover and one without.

- Put detergent in both sections for cycles with two washes.
- Put detergent in the covered section only for cycles with one wash.
- Push the cover down until it is latched.

The cover opens automatically when the main wash starts. Detergent in the open section falls into the dishwasher when the door is closed.

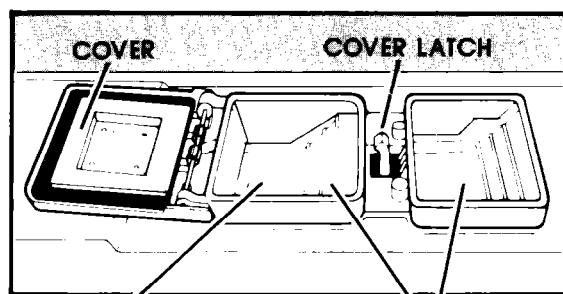
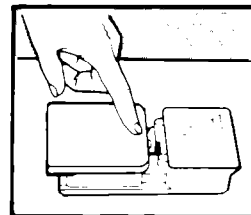

Use covered section for...
NORMAL Cycle
LOW ENERGY Cycle

Use both sections for...
POTS & PANS Cycle
HEAVY Cycle

How much detergent to use

The amount of detergent to use depends on the hardness of your water. If too little is used, dishes won't be clean. However, if too much is used in soft water, glassware will begin to etch.

Find out your water's hardness by asking your local water department, water softener company or county extension agent.

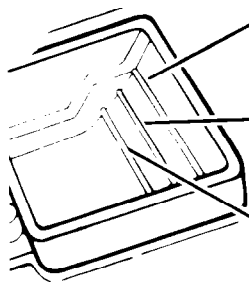

- **HARD** – Fill 1 or both sections to top line if water hardness is 8 or more grains per gallon, or 136 or more parts per million.
- **MEDIUM** – Fill 1 or both sections to middle line if water hardness is 5 to 7 grains per gallon, or 85 to 119 parts per million.
- **SOFT** – Fill 1 or both sections to bottom line if water hardness is 0 to 4 grains per gallon, or 0 to 68 parts per million.

Rinse aid dispenser

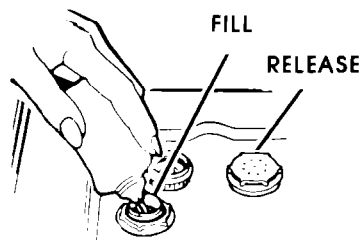

A rinse aid helps keep water from forming droplets and drying as spots. Keep the dispenser filled with a rinse aid such as Jet-Dry.[®] A small amount is released automatically during the final rinse of each cycle. Check the dispenser periodically to see if it needs refilling.

Keep the dispenser fill cap tightly closed.

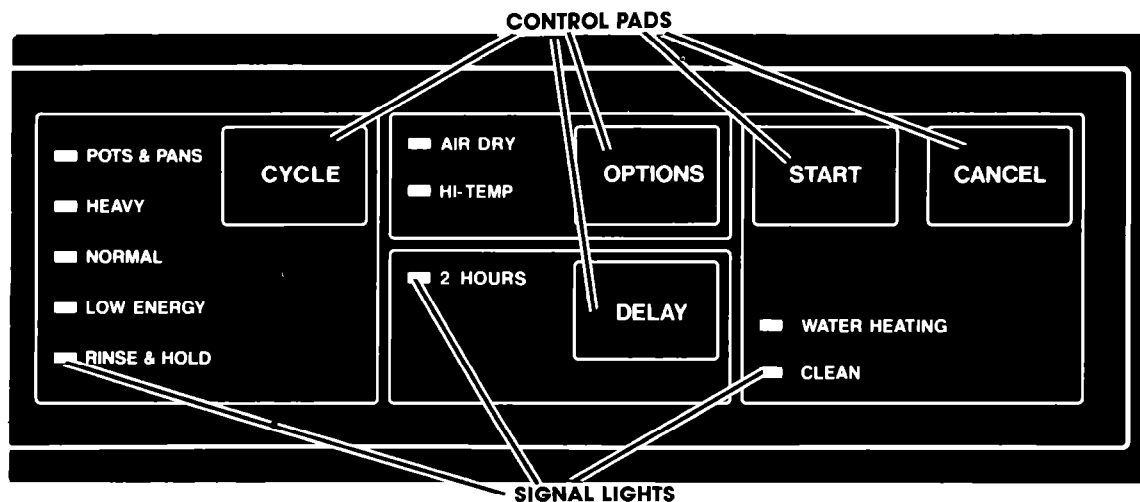

Starting your dishwasher

Five control pads and the signal lights allow you to set and check the dishwasher's function. A "beep" sounds each time a pad is pressed under normal conditions.

When first installed, the signal lights will flash rapidly in order. The signal lights will also flash following a power failure. Press the **CANCEL** pad **twice** to clear the signal lights. **To start the dishwasher**, press the **START** pad once to display the cycle. The dishwasher is preset for the **NORMAL** cycle with the **HEAT DRY** option. If you want this cycle, press **START** again.

To select a different cycle and/or option, just press the **CYCLE** pad and/or **OPTIONS** pad until the cycle and/or option you want is indicated by the signal lights. Each press of the pad advances the signal light to the next cycle or option. Press **START** to begin the cycle you selected. After each use, the dishwasher remembers the cycle and options used. The next time the display is lit up for selection, it will show the last cycle that was run.

When dishes are loaded and ready to be washed...

1. Read "Important Safety Instructions" on page 2 before starting your dishwasher.
2. Spin the Upper and Lower Spray Arms to make sure nothing will stop them from turning freely.
3. Push door firmly when closing and it will automatically latch.
4. Run hot water at sink nearest dishwasher until it is hot. Turn it off.
5. Press the **START** pad. Skip to step 7 if you want to run the cycle indicated by the signal lights.
6. You may select a different cycle by pressing the **CYCLE** pad. You may select a different option by pressing the **OPTION** pad.
7. Press the **START** pad again.

NOTE: Cycle and option selections are cancelled by a power failure.

Selecting a cycle

POTS & PANS

Maximum cleaning for cooked-on or baked-on foods. The cycle time delays while the dishwasher automatically heats the water to 145°F (63°C) in both washes and in the last rinse (marked *). Cycle time** is 72 minutes plus the time needed to heat the water.

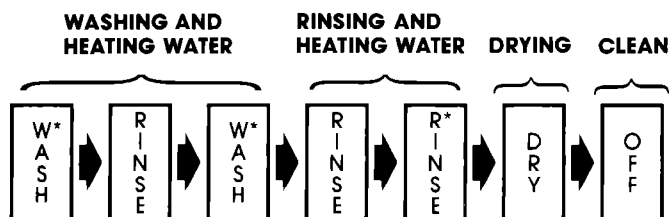

HEAVY

A double wash for heavily soiled loads. Cycle time** is about 72 minutes plus the time needed to heat the water if the HI-TEMP option is selected.

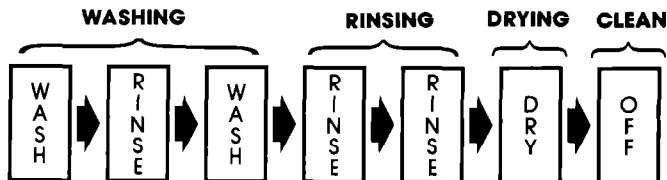

NORMAL

For normal, everyday soiled loads. (The Energy Guide Label is based on this cycle.) Cycle time** is about 65 minutes plus the time needed to heat the water if the HI-TEMP option is selected.

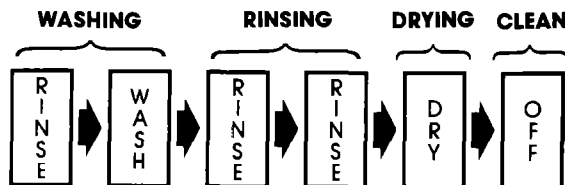

LOW ENERGY

For pre-rinsed or lightly soiled loads. Cycle time is about 58 minutes plus the time needed to heat the water if the HI-TEMP option is selected.

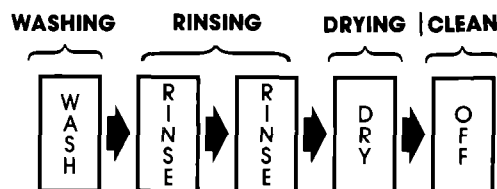

RINSE & HOLD

For rinsing a few items to be washed one or more days later. Cycle time is about 12 minutes.

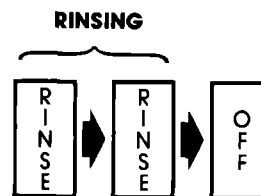

**Cycle time includes heated dry times.

Selecting an option

Options can be selected by pressing the OPTIONS Pad. Each press of the Pad advances the selection to the next option: HEAT DRY & HI-TEMP, AIR DRY, AIR DRY & HI-TEMP, HEAT DRY. For example, if the AIR DRY signal light is on and you want to select HEAT DRY, press the OPTIONS Pad twice.



HEAT DRY and HI-TEMP



AIR DRY



AIR DRY and HI-TEMP



HEAT DRY

All options can be changed any time during a cycle. If the RINSE & HOLD cycle is selected, options are not available. The HI-TEMP Option is already preset for the POTS & PANS cycle, so only HEAT DRY or AIR DRY Options can be selected for the cycle.

continued on next page

HEAT DRY



The AIR DRY signal light will be OFF when HEAT DRY is selected. Heat Dry means the air in the dishwasher is heated during

the "dry" portion of any cycle – except RINSE & HOLD.

AIR DRY



The AIR DRY signal light will be ON when AIR DRY is selected. The AIR DRY Option helps save energy, but the dishes take

longer to dry (overnight) and some water spotting may result. Some items (such as plastics) may need towel drying. For best results, use a liquid rinse aid such as Jet-Dry® in the rinse aid dispenser.

HI-TEMP



When HI-TEMP is selected, the water for the main wash and final rinse is heated to 145°F (63°C).

While the water is heating, the WATER HEATING signal light will be ON. POTS & PANS has the HI-TEMP option preset. HI-TEMP cannot be selected with RINSE & HOLD.

NOTE: The WATER HEATING signal light will flash at the end of the cycle if the water did not heat to 145°F (63°C). (See page 17).

DELAY Pad



The DELAY Pad allows you to delay the start of a cycle for 2 hours after load-

ing the dishwasher. For example, use DELAY to run the dishwasher during off-peak hours of electrical use.

1. Press the DELAY pad once to display the last cycle and options selection.
2. Quickly press the pad again to select a 2 hour delay. The 2 HOURS signal light will come on.

3. Pressing the DELAY Pad repeatedly will select (in order) no delay, then 2 hours, etc. If no delay is selected, all delay signal lights will be off.

4. After 2 hours, the signal light will turn off and the dishwasher will start.

- You may press START at any time during the delay if you want the dishwasher to start immediately.
- Press the CANCEL pad to cancel the delay and clear the delay signal light.
- You may add items to the load at any time during the delay. **Close the door firmly to latch it.**

CANCEL Pad



The CANCEL pad allows you to cancel a cycle, to clear the signal lights or to make a new selection.

If the dishwasher is washing, it will go into a 2 minute drain automatically before shutting off. Pressing CANCEL again stops the drain. If the dishwasher had not been started or is not washing, it will clear the display. Pressing CANCEL again will start a 2 minute drain, if needed.

WATER HEATING signal light



The WATER HEATING signal light comes on automatically during the HEAVY, NORMAL and LOW ENERGY Cycles to show that water is being heated. The heating time is preset for each cycle, and heats the water a few degrees to improve washability. The WATER

HEATING signal light will go off automatically when the preset heating time is up.

NOTE: The water will stop heating once the preset time is up. If you want to make sure the water gets heated to 145°F (63°C), use the HI-TEMP Option (see page 10).

Selecting an extra feature

Four of the control pads serve two purposes. Besides the functions already listed, they control these extra features:

CONTROL PAD	START PAD	OPTIONS PAD	CYCLE PAD	DELAY PAD
EXTRA FEATURE	Begins CYCLE PAUSE.	Cancels CLEAN signal light when door is opened.	Locks out control pads.	Turns "beep" ON/OFF.

These features are described below.

CYCLE PAUSE

A cycle can be stopped at any time for up to 10 minutes.

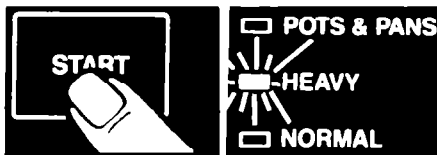

1. To pause during a cycle, press the START pad. Any signal lights that are on will flash until the cycle restarts after 10 minutes.



2. The cycle can be started sooner by pressing the START pad again.

CLEAN signal light



The CLEAN signal light comes on at the end of a cycle to show that the load is clean. It will stay on until CANCEL or any other control pad is pressed.

As an option, you can have the CLEAN light turn off the first time you open the door after a cycle is finished:



1. Press and hold the OPTIONS pad until the CLEAN signal light starts flashing.
2. Release the pad.

To again have the signal light stay on when the door is opened:



1. Press and hold the OPTIONS pad until the CLEAN signal light turns on.
2. Release the pad.

Control pad lock-out feature

This feature lets you lock-out the function of the control pads (except to CANCEL a cycle that is running or to pause during a cycle in progress).

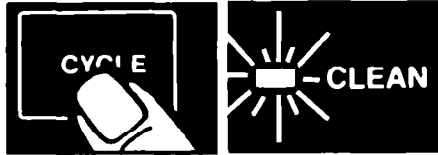

1. Press and hold the CYCLE pad until the CLEAN signal light flashes.
2. Release the pad.



3. The CLEAN signal light will turn off to show that the control pads are locked-out.

The beeping sound

Each time a control pad is pressed, a single "beep" sound is made. A double beep means one of the extra features was selected or the wrong control pad was used.

To turn off the beep:

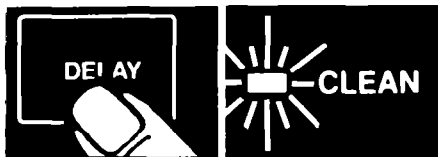

1. Press and hold the DELAY pad until the CLEAN signal light flashes.
2. Release the pad.

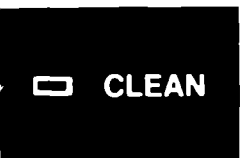

3. The CLEAN signal light will turn off to show that the beep is turned off.

To cancel the lock-out feature:



1. Press and hold the CYCLE pad until the CLEAN signal light turns on and stays on.
2. Release the pad.



3. The CLEAN signal light will turn off to show that the control pads are no longer locked out.

To turn the beep back on:



1. Press and hold the DELAY pad until the CLEAN signal light turns on and stays on.
2. Release the pad.



3. The CLEAN signal light will turn off to show that the beep has been turned on.

NOTE: All extra feature selections are cancelled by a power failure.

Energy saving tips

You can help save energy if you:

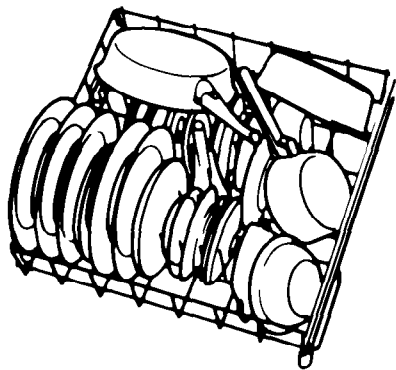

1. **Wash full loads.** Running a half-filled dishwasher uses the same amount of electricity and hot water as a fully loaded machine.

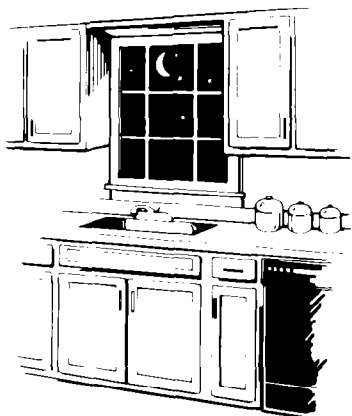

3. **Air dry dishes** when you don't need a rapid drying cycle. Allow longer drying times (overnight).

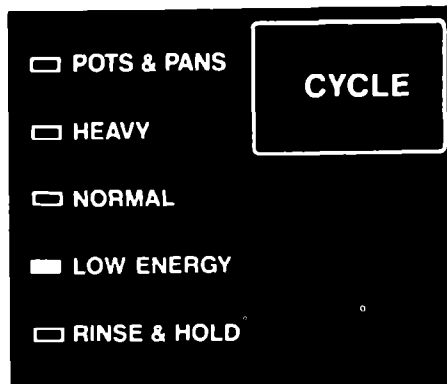
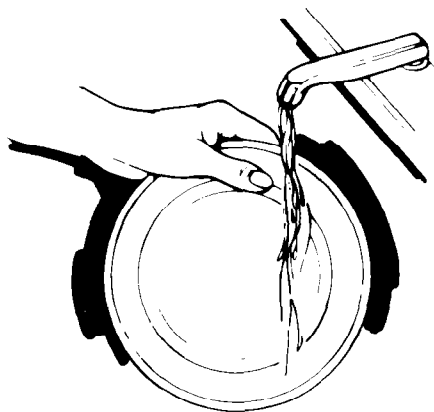

2. Use the **LOW ENERGY Cycle** whenever possible. It uses less hot water and energy than other wash cycles.

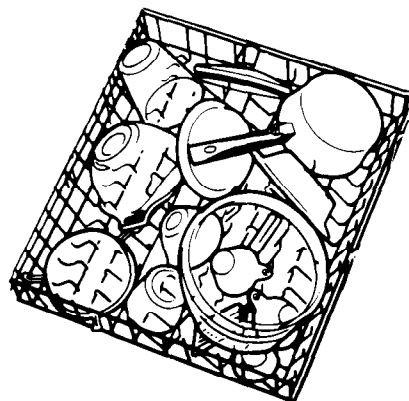

4. **Load correctly** for best washing results. Incorrect loading may cause poor washing and the need to rewash all or part of the load.
5. **Don't pre-rinse normally soiled dishes.** Select the correct cycle for the load and use the recommended amount of detergent for good washing results without hand rinsing.
6. **Use your dishwasher** during off-peak hours. Local utilities recommend this to avoid heavy usage of energy at certain times of day.
7. **Kitchen cleanup** can be done quickly and efficiently through the use of your dishwasher. Most appliance parts that can fit in the dishwasher can be cleaned by it. Burned-on soil, however, should be cleaned by hand.

Special tips on dishwasher use

Remember, use your dishwasher only for the job it was designed to do. Some items are not dishwasher safe or may require special care. Read these special tips for the following items:

Aluminum: Aluminum loses its bright, shiny appearance and darkens in color due to minerals in the water and the alkalinity of the dishwasher detergent. Colored aluminum may fade.

TIPS: If washed in the dishwasher avoid placing directly in front of detergent dispenser where it could be sprinkled with undissolved detergent, causing spotting, pitting, and discoloration. Follow utensil manufacturers' cleaning instructions.

China: Hand-painted, metal-trimmed, and antique china fade due to high water temperatures and alkaline detergent solution in the dishwasher. **NOTE: Delicate, antique items should not be washed in the dishwasher.**

TIPS: Load china carefully. **Do not** allow pieces to touch each other. Test one piece by washing it daily in the dishwasher for several weeks. Then compare it with the rest of the set to see if colors have changed.

Crystal and decorative glasses: Crystal can break from sudden exposure to high water temperature. Metal trim and colorful decoration on glass will fade in time when washed in the dishwasher. **NOTE: Delicate, antique items should not be washed in the dishwasher.**

TIPS: Load crystal carefully in **top rack only**. Be sure to load a few larger items in the bottom rack to reduce amount of force of water spray reaching glassware from lower spray arm. Use the shortest cycle.

Flatware: Salty and acidic foods may tarnish silver and stainless flatware if allowed to remain on the utensils. A film may form on sterling silver and silver plate items washed in a dishwasher. This film is caused by reaction of silver with chlorine in the detergent. **Gold flatware is not dishwasher safe.**

TIPS: Rinse flatware as soon as possible, especially if it is not to be washed right away. Dishwasher detergent may remove antique finishes. Wash by hand. Tarnish and film build-up can be removed with silver polish.

Cast iron utensils: The seasoned finish will be removed in the dishwasher. Rusting will result.

TIPS: Wash by hand. To re-season, coat with unsalted fat and heat in a slow oven for an hour or two.

Plastics: Many plastics will have "Dishwasher Safe" written on them. Some plastics are heat sensitive and may melt or warp.

TIPS: If in doubt, try one piece. Place in upper rack only. AIR DRY option provides additional protection.

Non-stick finish utensils: Most can be washed in the dishwasher.

TIPS: Follow manufacturers' suggestions.

Wood: Many wooden items will crack and warp or lose their finish.

TIPS: Do not wash cutting boards, wooden salad bowls or knives with wooden handles in the dishwasher.

Pewter or pewter-like materials: May streak, discolor, and pit.

TIPS: To keep pewter at its very best, hand wash with mild detergent.

Dishwasher care & cleaning:

Exterior – Regular use of a soft damp cloth or sponge and a mild detergent is all that is necessary, in most cases, to keep the outside of your dishwasher nice looking and clean. **Interior** – Hard water minerals may cause a white film to build-up on the inside surfaces, especially just beneath the door area.

Wear rubber gloves when cleaning the dishwasher interior. **Do not use any type of cleanser other than dishwasher detergent because it may cause foaming or sudsing.**

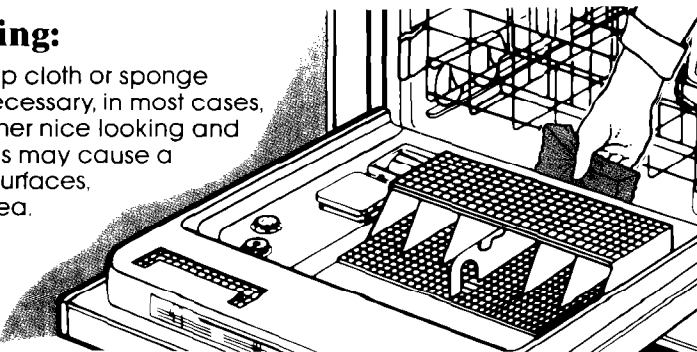

Common dishwashing problems

PROBLEM	CAUSED BY	SOLUTION
Spotting and filming (hard water film)	Hard water	Fill detergent dispensers to capacity. Use dishwasher detergent with highest available phosphorus content. May be necessary to install water softener. To remove spots and film, try a vinegar rinse... 1. Wash and rinse load as usual. Use AIR DRY. 2. Remove all metal items. 3. Put 2 cups (500 mL) white vinegar in a container on the bottom rack. 4. Run dishwasher through a complete washing cycle.
	Water is not hot enough	Water temperature should be at least 140°F (60°C). Set water heater thermostat to a higher setting. Run water at sink until hot before starting and/or use HI-TEMP WASH Option.
	Not enough detergent, or improper detergent "Old" detergent	Use more dishwasher detergent. Use detergent with highest available phosphorus content...especially with hard water. Use only fresh dishwasher detergent. Store tightly closed container, in cool, dry place. Discard old detergent. Do not fill dispensers until ready to start dishwasher.
	Improper loading	Make sure dishes and glassware are loaded so spray reaches all surfaces and items drain properly. Do not overload. Do not nest items. Make sure large items do not block spray from reaching detergent dispensers.
	No rinse aid	Does the rinse aid dispenser need filling? See instructions on page 7.
	AIR DRY Setting used	Drying without heat may result in some spotting of glasses and silver.
Small particles deposited on items	Spray arm or arms not rotating freely "Old" detergent	Check spray arms to make sure they turn freely after loading. Be sure a utensil has not prevented their turning. Use only fresh dishwasher detergent. Store tightly closed container, in cool, dry place. Discard old detergent. Do not fill dispensers until ready to start dishwasher.
	Not enough detergent, or improper detergent	Use more dishwasher detergent. Use detergent with highest available phosphorus content...especially with hard water.
	Water is not hot enough	Water temperature should be at least 140°F (60°C). Set water heater thermostat to a higher setting. Run water at sink until hot before starting and/or use HI-TEMP WASH Option.
	Water pressure may be low, dishwasher is not filling properly	If water pressure is low, do not use water for other purposes while dishwasher is running (to assure correct fills).
	Dishes not dry	Water is not hot enough
Improper loading		Make sure dishes and glassware are loaded so spray reaches all surfaces and items drain properly. Do not overload. Do not nest items.
No rinse aid		Fill rinse aid dispenser.
AIR DRY Setting used		Allow more time when using AIR DRY Option, or use HEAT DRY. Plastic items may need towel drying.
Black marks on dishes	Aluminum utensils rubbing against items during washing	Use care in loading aluminum utensils, especially any lightweight foil container. Place so they do not touch dishes. Remove black marks with plastic scouring pad and a mild abrasive cleanser.
Chipping or breaking glassware	Improper loading	Do not overload. Load glasses in the top rack only. Load between prongs, not over them. Glasses loaded over prongs will not be supported and may chip or break.

PROBLEM	CAUSED BY	SOLUTION
Dishes not washing clean	Water is not hot enough	Water temperature should be at least 140°F (60°C). Set water heater thermostat to a higher setting. Run water at sink until hot before starting and/or use HI-TEMP WASH Option.
	Improper loading	Make sure dishes and glassware are loaded so spray reaches all surfaces and items drain properly. Do not overload. Do not nest items. Make sure large items do not block spray from reaching detergent dispensers.
	Spray arm or arms not rotating freely	Check spray arms to make sure they turn freely after loading. Be sure a utensil has not prevented their turning.
	Not enough detergent or improper detergent	Use more dishwasher detergent. Use detergent with highest available phosphorus content...especially with hard water.
	"Old" detergent.	Use only fresh dishwasher detergent. Store tightly closed container, in cool, dry place. Discard old detergent. Do not fill dispensers until ready to start dishwasher.
Cloudy film on glassware, etching – permanent corrosion	Water pressure may be low, dishwasher is not filling properly	If water pressure is low, do not use water for other purposes while dishwasher is running (to assure correct fills).
	Too much detergent in soft water	Check for rainbow hue on glasses. A rainbow hue is the first sign of etching (corrosion of glass). Reduce the amount of dishwasher detergent. Use a detergent with a lower phosphorus content.
Dishes & interior of dishwasher yellow or brown	Inadequate rinsing	If water pressure is low do not use water for other purposes while dishwasher is running (to assure correct water fills). Make sure dishes and glassware are loaded properly to assure adequate rinsing and draining. Do not overload.
	Iron or manganese in water	Temporary remedy: 1. Set empty dishwasher for a "one wash" cycle. 2. Start dishwasher and unlatch door to stop it when it has filled for the wash part of the cycle. 3. Add ¼ to ½ cup (120 to 240 mL) of citric acid crystals (usually available in drugstores). 4. Close and latch door to complete cycle. Permanent solution: Install an iron or manganese filter to home water supply.
Rust spots on stainless steel –OR- Dark spots on flatware – stainless steel, silver plate, or sterling	Allowing salty or acidic foods such as mayonnaise, vinegar, fruit juices, salad dressings, milk products to remain on flatware.	Rinse flatware that is to stand for several hours before washing (use Rinse & Hold). Clean stained items with silver polish and re-wash. Do not put stainless steel and silver flatware in the same silverware basket compartment. Direct contact between these metals can cause permanent damage to the silver.
	Undissolved detergent coming in contact with flatware	Remove spots with silver polish. Avoid spilling concentrated detergent on wet flatware.
Bronze tarnish on silverplate	Silverplate is worn off. Exposed base metal takes on a bronzed hue.	Remove tarnish with silver polish. Have silver replated.
Water left in bottom of dishwasher	Dishwasher cycle not completed	Allow dishwasher to complete cycle.
	Clogged drain air gap	Some plumbing codes require use of a drain air gap between an undercounter dishwasher and the drain system of the house. The air gap is usually located above the sink or on the top of the counter near the dishwasher to prevent the possibility of water backing up from the drain into the dishwasher due to a plugged drain. The drain air gap is NOT a part of the dishwasher and is NOT covered by the dishwasher warranty. The drain air gap should be kept clean to insure proper draining of the dishwasher.

If you need service or assistance, we suggest you follow these five steps:

1. Before calling for assistance... 2. If you need assistance*...

Performance problems often result from little things you can find and fix yourself without tools of any kind.

If your dishwasher will not run, or stops during a cycle:

- Is the door tightly closed and securely latched?
- Has the cycle been correctly set?
- Is the water turned on?
- Have you checked your home's main fuses or circuit breaker box?
- Is the dishwasher wired into a live circuit with the proper voltage?
- If the motor has stopped because of an overload, it will automatically reset itself within a few minutes. If the motor does not start, call for service.
- Is the delay feature on?

If your dishwasher seems to run too long:

- Are you using the POTS & PANS Cycle or HI-TEMP Washing Option? Is the dishwasher waiting for water to heat?

If water remains in the dishwasher:

- Has the cycle completed?
- A small amount of remaining water is normal.
- Is drain air gap or drain hose clogged?

If detergent remains in the covered detergent cup:

- Is the bottom rack in backwards? (The rack bumpers should be at the front.)
- Is the dishwasher detergent fresh and dry without lumps?
- Is the cycle completed?

If you hear grinding, grating, crunching, buzzing sounds:

- A hard object has probably entered the POWER CLEAN Module. The sound should stop when the object is ground up.

If the WATER HEATING Signal light flashes:

- Have you run water at the nearest sink before starting dishwasher?
- Is water temperature at least 140° F (60° C)? Set water heater thermostat to a higher setting.

If signal lights flash and the dishwasher stops or will not run:

- Has there been a power failure?
- Is the cycle pause feature on? (See page 11.)

If control pads don't work:

- Is the lock-out feature on? (See page 12.)

If the beep does not sound when pads are pressed:

- Has the sound signal been turned off? (See page 12.)

Call Whirlpool COOL-LINE® service assistance telephone number. Dial free from anywhere in the U.S.: 1-800-253-1301

and talk with one of our trained Consultants. The Consultants can instruct you in how to obtain satisfactory operation from your appliance or, if service is necessary, recommend a qualified service company in your area.

3. If you need service*...



Whirlpool has a nationwide network of franchised TECH-CARE® service companies. TECH-CARE service technicians are trained to fulfill the product warranty and provide after-warranty service, anywhere in the United States. To locate TECH-CARE service in your area, call our COOL-LINE service assistance telephone number (see Step 2) or look in your telephone directory Yellow Pages under:

APPLIANCES - HOUSEHOLD - MAJOR - SERVICE & REPAIR	OR	ELECTRICAL APPLIANCES - MAJOR - REPAIRING & PARTS
WHIRLPOOL APPLIANCES FRANCHISED TECH-CARE SERVICE		WHIRLPOOL APPLIANCES FRANCHISED TECH-CARE SERVICE
SERVICE COMPANIES		SERVICE COMPANIES
XYZ SERVICE CO 123 MAPLE	999-9999	XYZ SERVICE CO 123 MAPLE
	OR	
WASHING MACHINES, DRYERS & IRONERS - SERVICING		
WHIRLPOOL APPLIANCES FRANCHISED TECH-CARE SERVICE		
SERVICE COMPANIES		
XYZ SERVICE CO 123 MAPLE		999-9999

4. If you have a problem*...

Call our COOL-LINE service assistance telephone number (see Step 2) and talk with one of our Consultants, or if you prefer, write to:

Mr. Donald Skinner
Director of Customer Relations
Whirlpool Corporation
2000 M-63
Benton Harbor, MI 49022

5. If you need FSP® replacement parts*...

FSP® is a registered trademark of Whirlpool Corporation for quality parts. Look for this symbol of quality whenever you need a replacement part for your Whirlpool appliance. FSP replacement parts will fit right and work right, because they are made to the same exacting specifications used to build every new Whirlpool appliance.

To locate FSP replacement parts in your area, refer to Step 3 above or call the Whirlpool COOL-LINE service assistance number in Step 2.

*If you must call or write, please provide: model number, serial number, date of purchase, and a complete description of the problem. This information is needed in order to better respond to your request for assistance.

**POWER CLEAN* WASHING SYSTEM
PARTS COVERED BY YOUR
WARRANTY**

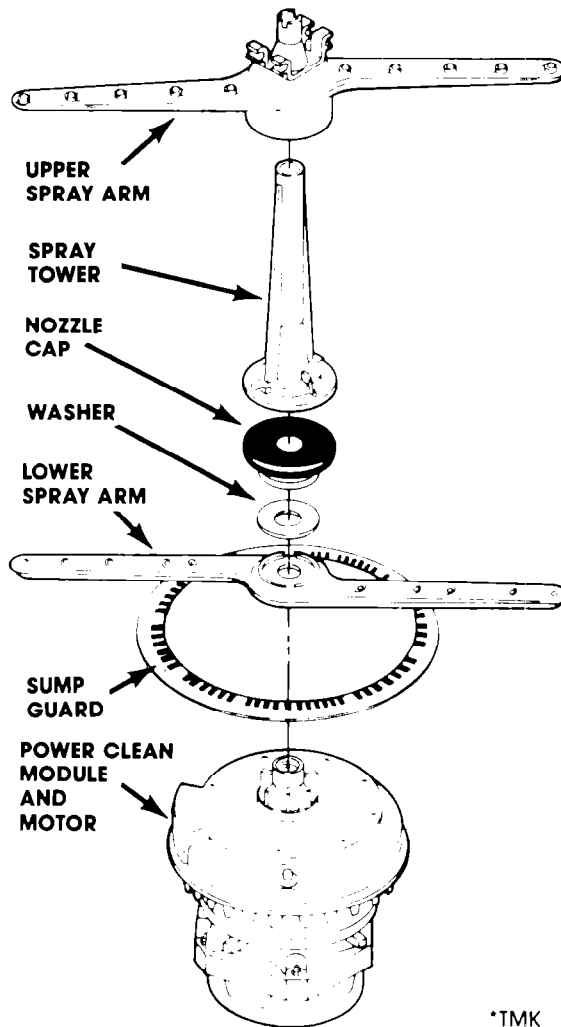

WHIRLPOOL® DISHWASHER WARRANTY

DW004

LENGTH OF WARRANTY	WHIRLPOOL WILL PAY FOR
FULL ONE-YEAR WARRANTY From Date of Purchase	FSP® replacement parts and repair labor to correct defects in materials or workmanship. Service must be provided by a franchised TECH-CARE® service company.
LIMITED TWO-YEAR WARRANTY From Date of Purchase	FSP replacement parts for any part of the POWER CLEAN* Washing System if defective in materials or workmanship. These parts are shown on page 19.
LIMITED FIVE-YEAR WARRANTY From Date of Purchase	FSP replacement parts for Electronic Control System if defective in materials or workmanship.
LIMITED TEN-YEAR WARRANTY From Date of Purchase	FSP replacement of the porcelain tub and/or DURAPERM* inner door should they fail to contain water due to defective materials or workmanship.
WHIRLPOOL WILL NOT PAY FOR	
<p>A. Service calls to:</p> <ol style="list-style-type: none"> 1. Correct the installation of the dishwasher. 2. Instruct you how to use the dishwasher. 3. Replace house fuses or correct house wiring or plumbing. <p>B. Repairs when dishwasher is used in other than normal, single-family household use.</p> <p>C. Pick up and delivery. This product is designed to be repaired in the home.</p> <p>D. Damage to dishwasher caused by accident, misuse, fire, flood, acts of God or use of products not approved by Whirlpool.</p> <p>E. Any labor costs during limited warranties.</p>	

WHIRLPOOL CORPORATION SHALL NOT BE LIABLE FOR INCIDENTAL OR CONSEQUENTIAL DAMAGES. Some states do not allow the exclusion or limitation of incidental or consequential damages so this limitation or exclusion may not apply to you. This warranty gives you specific legal rights, and you may also have other rights which vary from state to state.

Outside the United States, a different warranty may apply. For details, please contact your franchised Whirlpool distributor or military exchange.

*Tmk.



Part No. 3367701 Rev. B
© 1988 Whirlpool Corporation

Printed in U.S.A.

ers. Dishwashers. Built-In Ovens and Surface Units. Ranges. Microwave Ovens. Trash Compactors. Room Air Conditioners. Dehumidifiers. Automatic Washers. Clothes Dryers. Freezers. Refrigerator

