

# use & care guide

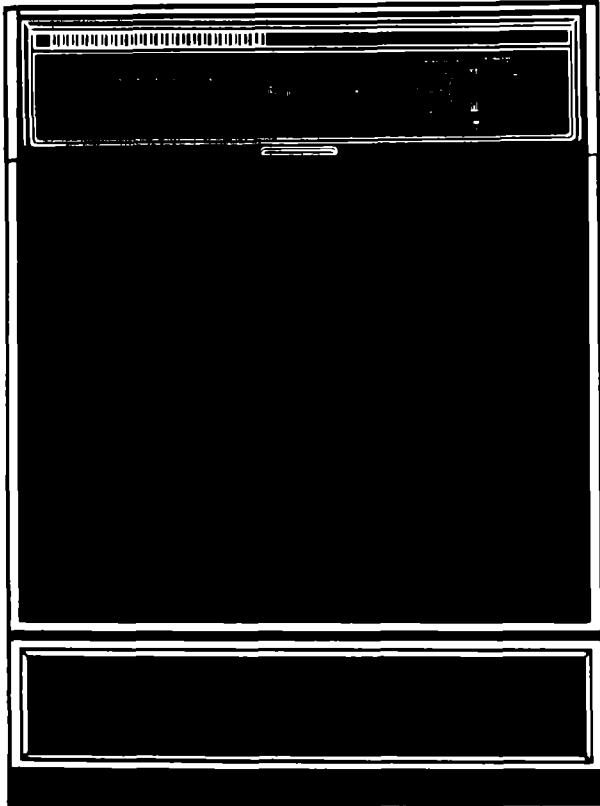

## UNDERCOUNTER DISHWASHER

Model DU8700XT Series

ers. Ice Makers. Dishwashers. Built-In Ovens and Surface Units. Ranges. Microwave Ovens. Trash Compactors. Room Air Conditioners. Dehumidifiers. Automatic Washers. Clothes Dryers. Freezers. R

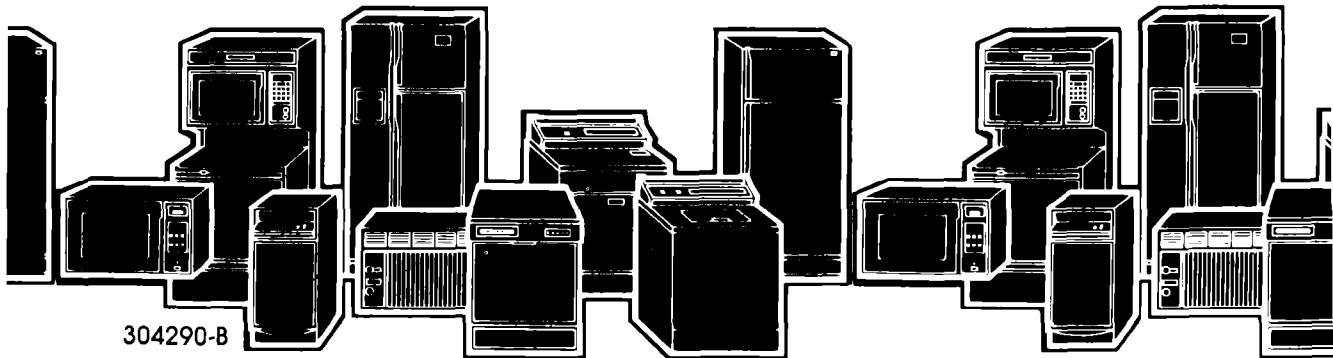

304290-B

# Contents

	Page		Page
<b>BEFORE YOU USE YOUR DISHWASHER</b> . . .	2	<b>BEFORE STARTING YOUR DISHWASHER</b> . . .	8
<b>IMPORTANT SAFETY INSTRUCTIONS</b> . . .	2	<b>STARTING YOUR DISHWASHER</b> . . . . .	8
<b>PARTS AND FEATURES</b> . . . . .	3	Selecting a Cycle . . . . .	8
<b>POWER CLEAN* WASHING SYSTEM</b> . . . . .	4	HI-TEMP WASH Option . . . . .	9
Step-Saving Preparation for Washing . . . . .	4	The AIR DRY Option . . . . .	9
Hot Water Is a Must . . . . .	4	The RESET OPTIONS Button . . . . .	9
Quiet Operating Tips . . . . .	4	Using DELAY START . . . . .	9
<b>PROPER LOADING</b> . . . . .	5	Changing a Setting . . . . .	9
Top Rack Loading . . . . .	5	The CLEAN Signal Light . . . . .	9
Bottom Rack Loading . . . . .	6	To Add a Dish After Starting . . . . .	9
Silverware Basket Loading . . . . .	6	<b>ENERGY SAVING TIPS</b> . . . . .	10
<b>ADDING DETERGENT</b> . . . . .	7	<b>SPECIAL TIPS ON DISHWASHER USE</b> . . .	11
The Detergent Dispenser . . . . .	7	<b>COMMON DISHWASHING PROBLEMS</b> . .	12
How Much Detergent to Use . . . . .	7	<b>IF YOU NEED SERVICE OR ASSISTANCE</b> .	14
<b>RINSE AID DISPENSER</b> . . . . .	7	<b>WHIRLPOOL DISHWASHER WARRANTY</b> . .	16

\*Tmk

©1989 Whirlpool Corporation

## Before you use your dishwasher



### It is your responsibility to be sure your dishwasher:

- Is installed by a qualified installer.
- Has been installed where it is protected from the elements.
- Has been installed on a floor strong enough to support its weight.
- Has been properly connected to electricity, water and drain.\*
- Has been properly electrically grounded.\*
- Has had all hang tags and temporary labels removed.
- Is not used by children or anyone unable to operate it properly.
- Is properly maintained.

\*See Installation Instructions for complete information.

## Important safety instructions

### ⚠ WARNING

To reduce the risk of fire, electrical shock, or injury when using your dishwasher, follow basic precautions including the following:

- **Read all instructions before using the dishwasher.**
- **DISHWASHER MUST BE ELECTRICALLY GROUNDED.** Read the Installation Instructions for details.
- Be sure your dishwasher is installed on a level floor that will hold the weight, and in an area suitable for its size and use.
- When discarding an old dishwasher, always remove the door to prevent accidental entrapment.
- **REMEMBER**, use your dishwasher only for the job it was designed to do.
- Store dishwasher detergent in a cool, dry place WHERE CHILDREN CAN'T REACH IT.
- Use **ONLY** detergents and rinse aids recommended for use in a dishwasher.
- Locate sharp items and knives so that they are not likely to damage door seal or cut the user.
- **DO NOT** let children play in or on the dishwasher.
- **DO NOT** reach into the area below the bottom rack until the heating element has cooled for at least 20 minutes.
- **DO NOT** wash plastic items unless marked "Dishwasher Safe" or the equivalent. If not marked, check manufacturer's recommendations.
- **DO NOT** use your dishwasher unless all enclosure panels are properly in place.
- **DO NOT** sit on, stand on or abuse the dishwasher door or dish racks.
- **DO NOT** tamper with controls.
- **If hot water has not been used recently (usually two weeks or longer), hydrogen gases may build up in the water heater and the hot water pipes. HYDROGEN GAS IS EXPLOSIVE. To prevent injury or damage, before using your dishwasher, turn on all hot water faucets and allow water to run for several minutes. This will allow gases to escape. Do not smoke or use any open flame near the faucet while it is open.**
- **Disconnect electrical power to the dishwasher before attempting to service.**

— SAVE THESE INSTRUCTIONS —

# Parts and features

## Model DU8700XT Series

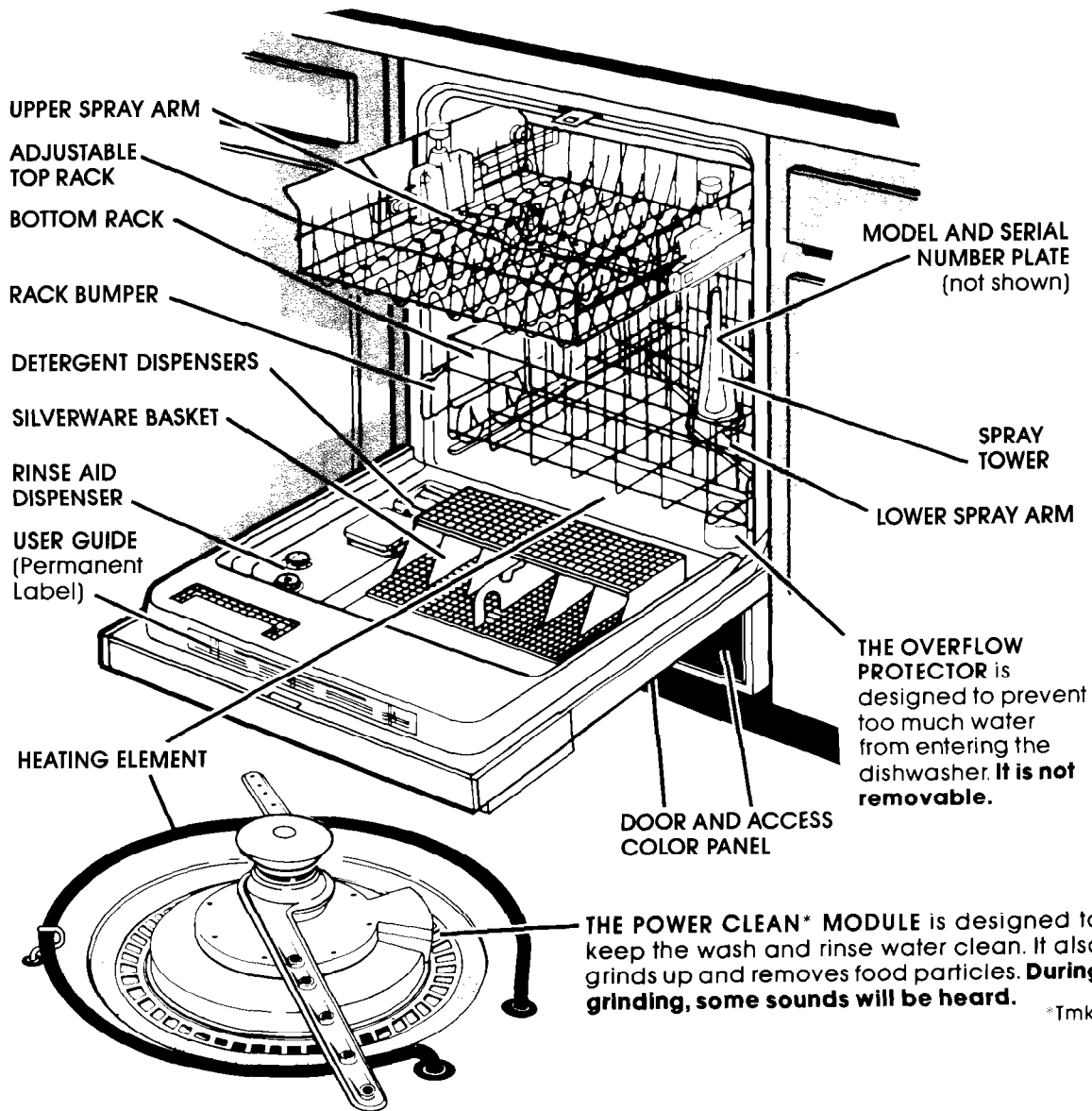

**Thank you for buying a Whirlpool appliance. Please complete and mail the Owner Registration Card provided with this product.** Then complete the form below. Have this information ready if you need service or call with a question.

- Copy Model and Serial Numbers from plate (see diagram above) and purchase date from sales slip.
- Keep this book and sales slip together in a handy place.

Model Number \_\_\_\_\_

Serial Number \_\_\_\_\_

Purchase Date \_\_\_\_\_

Service Company Phone Number \_\_\_\_\_

# POWER CLEAN\* Washing System

Your dishwasher cleans by spraying a mixture of hot, clean water and detergent against soiled surfaces of dishes. When a cycle is started, the dishwasher fills with water to about the level of the heating element. This water is pumped through the rotating spray arms, through the POWER CLEAN\* Module which removes food particles, and back through the rotating spray arms. Soiled water is pumped out and replaced with clean water during a cycle – the number of times depends on the cycle being used.

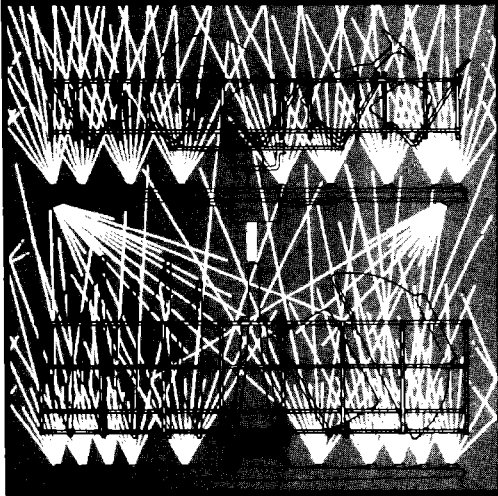

Load dishes so soiled surfaces face powerful spray from rotating arms.

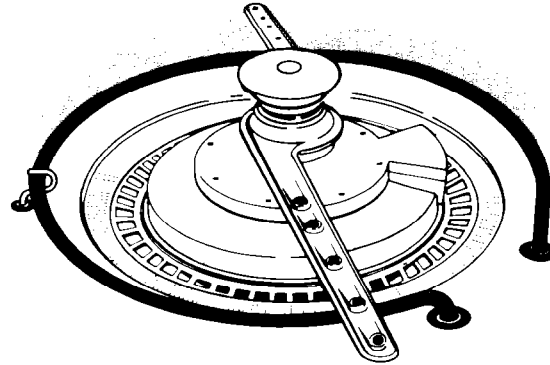

The POWER CLEAN\* Module removes food particles from the water, stores them, then washes them down the drain.

## Step-saving preparation for washing

It is not necessary to rinse dishes before putting them into the dishwasher. Just remove large pieces, bones, and other hard items. The POWER CLEAN\* Module will remove food particles from the water. It contains a chopping device which will reduce the size of food items.

If hard items such as fruit seeds, nuts and egg shells enter the POWER CLEAN\* Module, you

might hear chopping, grinding, crunching or buzzing sounds. Those sounds are normal when hard items enter the module. **DO NOT LET METALLIC ITEMS (I.E. POT HANDLE SCREWS) GET INTO THE POWER CLEAN\* MODULE. THIS COULD RESULT IN DAMAGE TO THE POWER CLEAN\* MODULE.**

## Hot water is a must

Hot water dissolves and activates the dishwashing detergent. Hot water dissolves grease on dishes and helps dry glasses spot-free. Make certain loads are washed in hot water (at least 140°F – 60°C). Two ways to have a reliable hot water supply...

1. Maintain 140°F water supply at central water heater. To check water temperature, turn on hot water faucet nearest the dishwasher. Let water run until it is as hot as possible, then check with a candy or meat thermometer. If

the temperature is too low, have a qualified person raise the water heater thermostat setting.

2. Use HI-TEMP WASH Option. If water heating is needed, a thermostat will delay the cycle until temperature reaches 145° (63°C). If water is hot enough, the cycle will proceed with no delay. This lets you turn down your water heater, if you choose, without cutting back on hot water needed for good dishwashing.

## Quiet operating tips

To avoid thumping and clattering noises during operation:

- Make sure lightweight load items are secured in the rack.
- Make sure pot lids and handles, pizza pans, cookie sheets, etc. do not touch interior walls

or interfere with either of the spray arms rotation.

- Load dishes so they **don't** touch one another.
- NOTE: Keep sink drain plugs inserted during dishwasher operation to prevent noise transfer through drains.**

\*Tmk

## Proper loading

Always load dishes so soiled surfaces are reached by spray from rotating spray arms. Water must be able to drain off completely for best drying results. Be careful to separate items so spray can reach all surfaces.

### Top rack loading

CUP AND GLASS LOAD

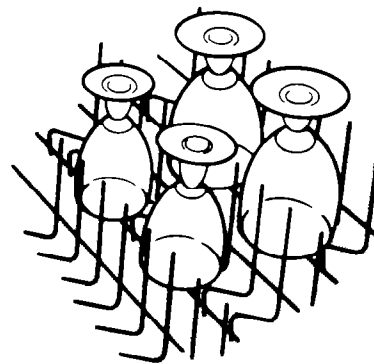
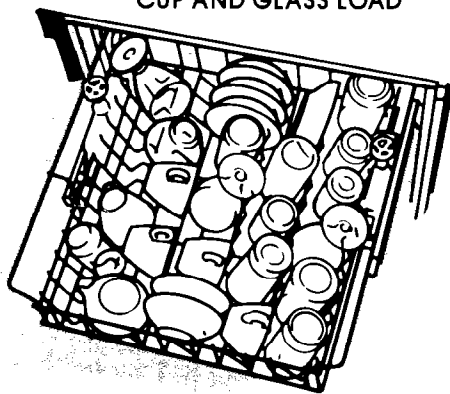

The top rack is designed for cups, glasses and smaller items.

- Place so open ends face down for cleaning and draining.
- **Load glasses in top rack only.** Bottom rack is not designed for glasses. Damage may occur.

- Place items in the rows **between** prongs. Placing them **over** the prongs can lead to breakage.
- Be sure lightweight items are held firmly in place.
- China, crystal and other delicate items must not touch each other during dishwasher operation. Damage may occur.

MIXED LOAD

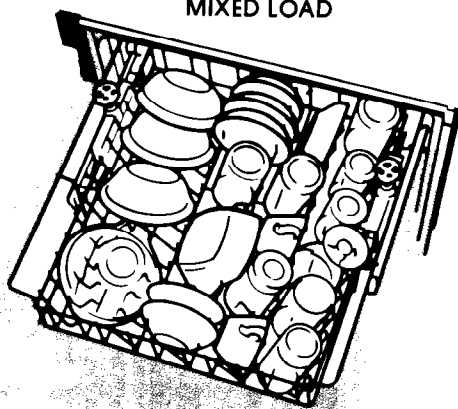

### ADJUSTABLE TOP RACK

The top rack does not have to be level.

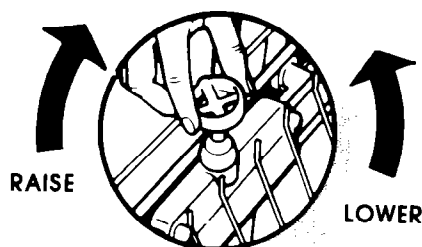

- Load plastic items **in the top rack only.** Only plastic items marked "dishwasher safe" are recommended.
- Plastic items can be melted in the bottom rack.
- Small bowls, pans and other utensils can be placed in the top rack.
- Items with cooked-on or dried-on foods should be loaded in the bottom rack with soiled surfaces facing the spray.

- Raise or lower one or both sides to help fit tall items in the top or bottom rack.
- Turn knob clockwise to raise a side.
- Turn knob counterclockwise to lower a side.

## Bottom rack loading

MIXED LOAD

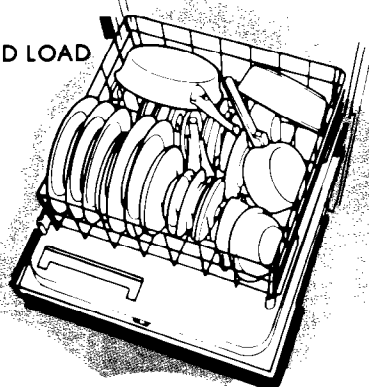

- Make sure pot handles and other items do not stop rotation of either the upper or lower spray arm. Spray arms must move freely.
- Load items so they do not block or cover the spray tower.
- Securely place heavily soiled cookware face down in rack.

DISH LOAD

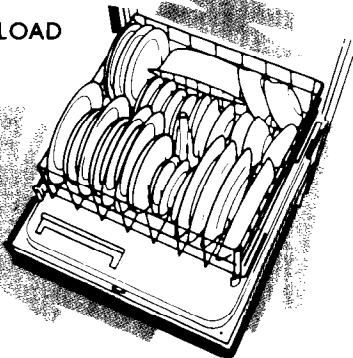

- Place plates, soup bowls, etc., **between** prongs and facing the spray.

UTENSIL LOAD

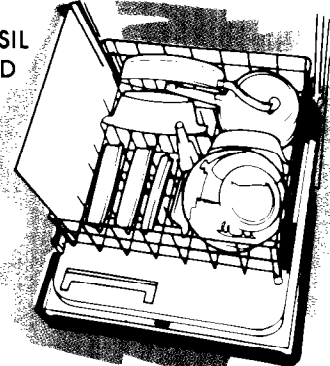

- Load cookie sheets, cake pans and other large items at sides or back. Loading such items in front may keep water spray from reaching detergent dispenser and silverware basket.

### NOTE:

- Do not load glasses, cups or plastic items in the bottom rack.
- When lower rack is removed, replace with bumpers in front.

## Silverware basket loading

Load forks and spoons so they **don't nest together**. Spray can't reach nested items.

NO



YES



Mix items in each section of the basket with some pointing up and some down. Small items – baby bottle caps, jar lids, etc. – can be put in any section.

## WARNING

### Personal Safety Hazard

**To avoid cuts from sharp items (knives, forks, skewers, etc.), make sure these items are put in point down.**

Make sure sharp items (knives, forks, skewers, etc.) are put in point down.

The silverware basket can be loaded while it's in place on the door, or it can be taken out for loading on the counter or table.

It can also be removed for easy unloading. Always unload or remove the basket before unloading the racks to avoid spilling water droplets on the silverware.

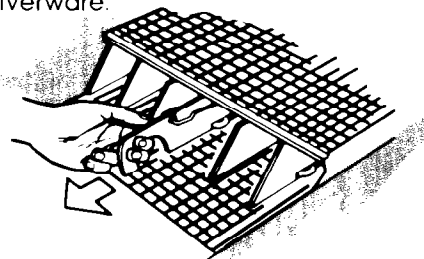

**To remove the basket**, slide it toward the top of the door – by the handle. Lift it off the holding buttons. Replace it in reverse order.

**To open the basket**, unhook the latch as shown. Be sure the cover is completely latched before pulling out the bottom rack and before closing the dishwasher door.

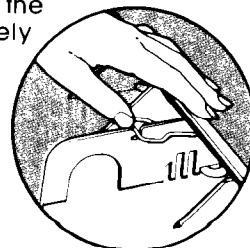

## Adding detergent

The kind and amount of dishwasher detergent you use is an important part of getting your dishes clean. Read this section carefully.

### Use automatic dishwasher detergent only.

Other detergents are too mild and much too sudsy to work in the dishwasher.

Different brands of dishwasher detergent have different amounts of phosphorus. Phosphorus softens water and helps prevent water spots on dishes.

If water is hard and phosphorus content is low (6.0% or less), you may need to use more detergent or use a brand with a higher phosphorus content (8.7% or higher).

Do not add detergent until you are ready to wash. When using Delay Wash, make sure the detergent dispensers are clean and dry before adding the detergent. **Fresh automatic dishwasher detergent is necessary for best washing results.** Store detergent tightly in a cool dry place.

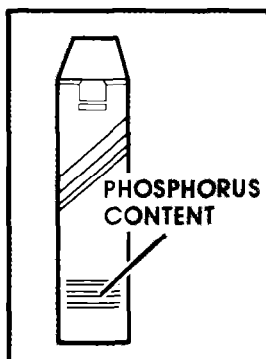
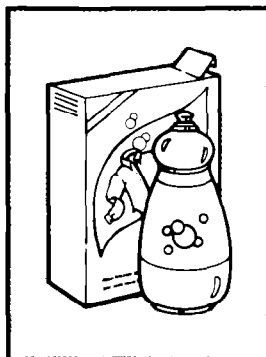

### The detergent dispenser

The detergent dispenser has one section with a cover and one without.

- Put detergent in both sections for cycles with two washes.
- Put detergent in the covered section only for cycles with one wash.
- Push the cover down until it is latched.

Detergent in the open section falls into the dishwasher when the door is closed. The covered section opens automatically when the main wash starts.

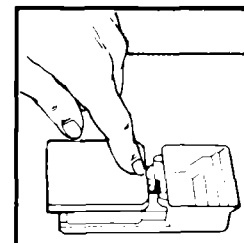

**NOTE:** It is normal for cover to open partially when dispensing detergent. The cover will open fully when the door is opened.

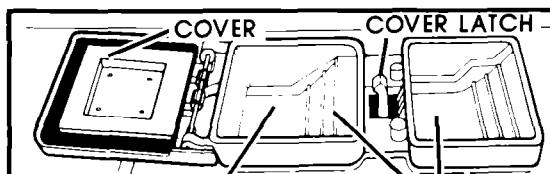

Use covered section for...  
**NORMAL WASH Cycle**  
**LOW ENERGY WASH Cycle**

Use both sections for...  
**POTS & PANS Cycle**  
**HEAVY WASH Cycle**

### How much detergent to use

The amount of detergent to use depends on the hardness of your water. If too little is used, dishes won't be clean. However, if too much is used in soft water, glassware will begin to etch.

Find out your water's hardness by asking your local water department, water softener company or county extension agent.

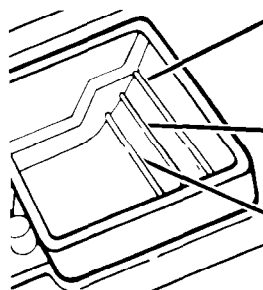

- **HARD** – Fill 1 or both sections to top line if water hardness is 8 or more grains per gallon, or 136 or more parts per million.
- **MEDIUM** – Fill 1 or both sections to middle line if water hardness is 5 to 7 grains per gallon, or 85 to 119 parts per million.
- **SOFT** – Fill 1 or both sections to bottom line if water hardness is 0 to 4 grains per gallon, or 0 to 68 parts per million.

### Rinse aid dispenser

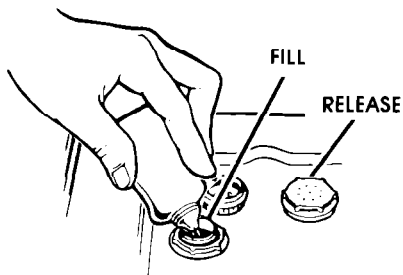

A rinse aid helps keep water from forming droplets and drying as spots. Keep the dispenser filled with a rinse aid such as Jet-Dry.<sup>®</sup> A small amount is released automatically during the final rinse of each cycle.

Check the dispenser periodically to see if it needs refilling. An "E" will be visible inside dispenser when it is empty. Make sure dishwasher door is fully open when refilling. Do not fill past the smallest opening in the lower part of the dispenser. If you overfill, excess rinse aid can come out. This will not harm the dishwasher. Keep the dispenser fill cap tightly closed.

## Before starting your dishwasher

1. Read "Important Safety Instructions" on page 2 before starting your dishwasher.
2. Spin the Upper and Lower Spray Arms to make sure nothing will stop them from turning freely.
3. Push door firmly when closing and it will automatically latch.
4. Run hot water at sink nearest dishwasher until it is hot. Turn it off.

## Starting your dishwasher

1. Push a Cycle Selector Button for the desired cycle. (Use NORMAL WASH for RINSE & HOLD Cycle.)
2. Push Option Selector Button for desired option or options. (Use AIR DRY for RINSE & HOLD Cycle.)
3. Turn Cycle Control Knob clockwise to point to a desired cycle. You will feel a definite stop at each cycle mark.

OPTION SELECTOR BUTTONS

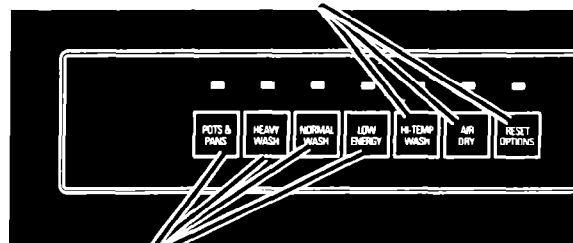

CYCLE SELECTOR BUTTONS

– POTS & PANS and HEAVY WASH Cycles share the same spot on the dial. The Cycle Selector Button determines which cycle operates.

The dishwasher will automatically start the selected cycle.

## Selecting a cycle

### POTS & PANS Cycle

Maximum cleaning for cooked- or baked-on foods. Timer delays while the dishwasher automatically heats the water to 145°F (63°C) in both washes and the last rinse (marked \*). Cycle time will be about 1½ to 2 hours, depending on time needed to heat water.

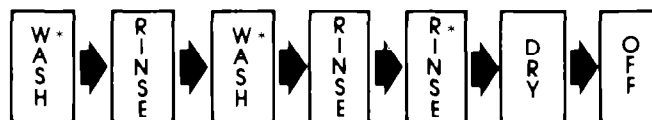

### HEAVY WASH Cycle

A double wash for heavily soiled loads. Cycle time is about 76 minutes.

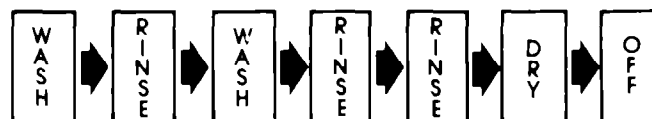

### NORMAL WASH Cycle

For normal, everyday soiled loads. (The Energy Guide Label data is based on this cycle.) Cycle time is about 68 minutes.

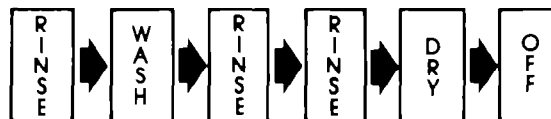

### LOW ENERGY WASH Cycle

For pre-rinsed or lightly soiled loads. Cycle time is about 60 minutes.

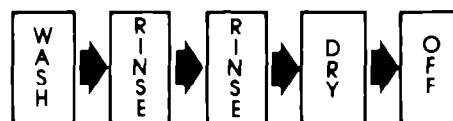

### RINSE & HOLD Cycle

For rinsing a few items to be washed one or more days later. Cycle time is about 14 minutes.

Use AIR DRY only. Do not use HI-TEMP WASH Option.





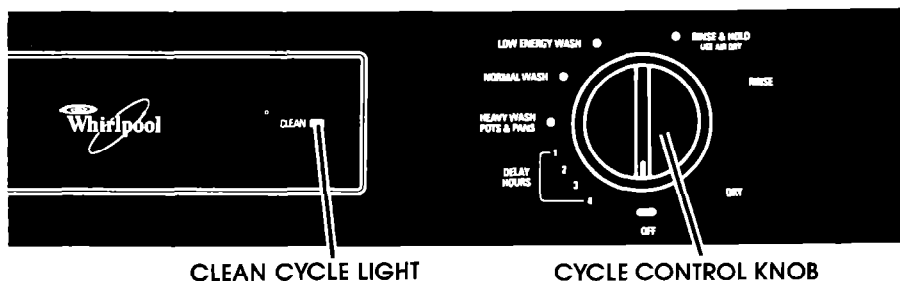

CLEAN CYCLE LIGHT

CYCLE CONTROL KNOB

## HI-TEMP WASH Option

When this option is selected, water for the main wash and the final rinse is heated to 145° F (63° C). Washing and rinsing action in those

parts of the cycle will be longer if the water is heated. HI-TEMP washing is automatic in POTS & PANS.

## The AIR DRY Option

Air in the dishwasher is automatically heated during the "dry" part of all cycles.

If the **AIR DRY Option** is selected, air in the dishwasher is not heated. Using this option helps save energy, but dishes take longer to dry (over-

night) and some water spotting may result. Some items (such as plastics) may need towel drying.

For best results, use a liquid rinse aid such as Jet-Dry.<sup>®</sup>

## The RESET OPTIONS Button

If you want to change a selected option, push the RESET OPTIONS Button. Re-select an option, if desired.

## Using DELAY START

1. Push desired Cycle Selector Button.
2. Push desired Option Selector Button(s).
3. Turn Control Knob clockwise to the number of hours (from 1 to 4 hours) you want the dishwasher to delay before the selected cycle starts.

4. Close and latch the door.

### NOTES:

- You can add items while time is counting down. Close and latch the door. The timer will not advance if the door is unlatched.
- RINSE & HOLD and LOW ENERGY WASH Cycles cannot be delayed.

## Changing a setting

You can change a setting anytime during any cycle.

1. Lift up on the door latch to stop the cycle. Don't open the door until the spray arms stop spinning.

2. Turn the Cycle Control Knob clockwise to the cycle you want.
3. Be sure the detergent dispensers are filled properly for the new cycle.
4. Press door firmly to latch it. The dishwasher will automatically start the new cycle.

## The CLEAN Signal Light

The CLEAN Signal Light will come on when a washing cycle is complete.

To turn light off, turn the Control Knob clockwise **slightly** until the light goes off.

## To add a dish after starting

1. To be sure the added item is washed and rinsed, make sure the Cycle Control Knob has not passed LOW ENERGY WASH.
2. Lift up on the door latch to stop the cycle. Don't open the door until the spray arms stop spinning.
3. Open the door and add the dish.

4. Close the door. **Do not latch it.** Wait 30 seconds for air in the dishwasher to warm up. This helps reduce the amount of moisture that can come from the vent when restarting the cycle.
5. Press door firmly to latch it. The dishwasher will start from where it stopped.

# Energy saving tips

You can help save energy if you:

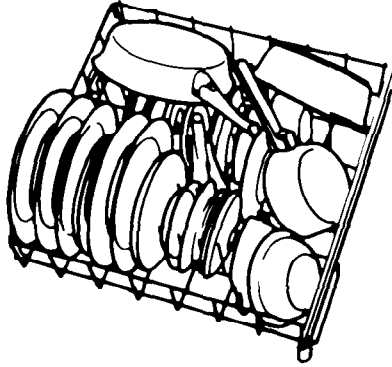

1. **Wash full loads.** Running a half-filled dishwasher uses the same amount of electricity and hot water as a fully loaded machine.

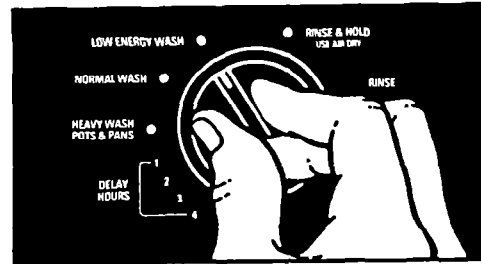

2. Use the **LOW ENERGY WASH Cycle** whenever possible. It uses less hot water and energy than other wash cycles.

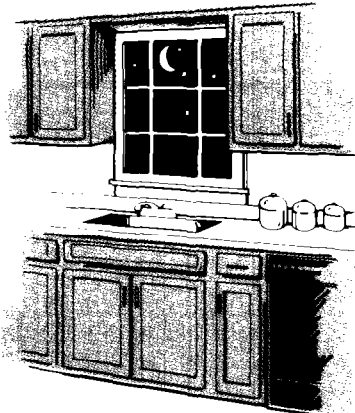

3. **Air dry dishes** when you don't need a rapid drying cycle. Allow longer drying times (overnight).

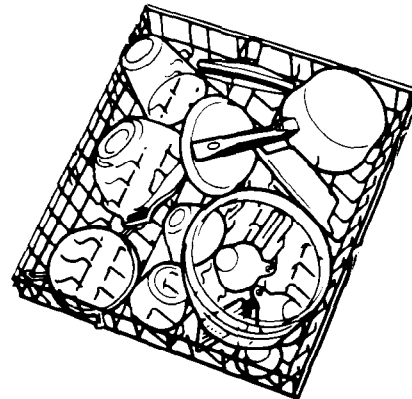

4. **Load correctly** for best washing results. Incorrect loading may cause poor washing and the need to rewash all or part of the load.

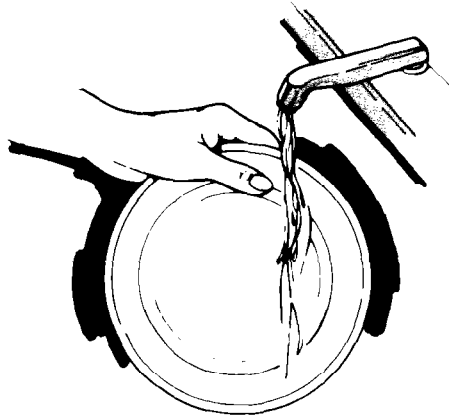

5. **Don't pre-rinse normally soiled dishes.** Select the correct cycle for the load and use the recommended amount of detergent for good washing results without hand rinsing.
6. **Use your dishwasher** during off-peak hours. Local utilities recommend this to avoid heavy usage of energy at certain times of day.
7. **Kitchen cleanup** can be done quickly and efficiently through the use of your dishwasher. Most appliance parts that can fit in the dishwasher can be cleaned by it. Burned-on soil, however, should be cleaned by hand.

## Special tips on dishwasher use

Remember, use your dishwasher only for the job it was designed to do. Some items are not dishwasher safe or may require special care. Read these special tips for the following items:

**Aluminum:** Aluminum loses its bright, shiny appearance and darkens in color due to minerals in the water and the alkalinity of the dishwasher detergent. Colored aluminum may fade.

**TIPS:** If washed in the dishwasher avoid placing directly in front of detergent dispenser where it could be sprinkled with undissolved detergent, causing spotting, pitting, and discoloration. Follow utensil manufacturers' cleaning instructions.

**China:** Hand-painted, metal-trimmed, and antique china fade due to high water temperatures and alkaline detergent solution in the dishwasher. **NOTE: Delicate, antique items should not be washed in the dishwasher.**

**TIPS:** Load china carefully. **Do not** allow pieces to touch each other. Test one piece by washing it daily in the dishwasher for several weeks. Then compare it with the rest of the set to see if colors have changed.

**Crystal and decorative glasses:** Crystal can break from sudden exposure to high water temperature. Metal trim and colorful decoration on glass will fade in time when washed in the dishwasher. **NOTE: Delicate, antique items should not be washed in the dishwasher.**

**TIPS:** Load crystal carefully in **top rack only**. Be sure to load a few larger items in the bottom rack to reduce amount of force of water spray reaching glassware from lower spray arm. Use the shortest cycle.

**Flatware:** Salty and acidic foods may tarnish silver and stainless flatware if allowed to remain on the utensils. A film may form on sterling silver and silver plate items washed in a dishwasher. This film is caused by a reaction of silver with chlorine in the detergent. **Gold flatware is not dishwasher safe.** The adhesive used in some flatware with hollow handles is not heat resistant, causing the handles to come off in the dishwasher. Wash by hand.

**TIPS:** Rinse flatware as soon as possible, especially if it is not to be washed right away. Dishwasher detergent may remove antique finishes. Wash by hand. Tarnish and film build-up can be removed with silver polish.

**Cast iron utensils:** The seasoned finish will be removed in the dishwasher. Rusting will result.

**TIPS:** Wash by hand. To re-season, coat with unsalted fat and heat in a slow oven for an hour or two.

**Plastics:** Many plastics will have "Dishwasher Safe" written on them. Some plastics are heat sensitive and may melt or warp.

**TIPS:** If in doubt, try one piece. Place in upper rack only. AIR DRY option provides additional protection.

**Non-stick finish utensils:** Most can be washed in the dishwasher.

**TIPS:** Follow manufacturers' suggestions.

**Wood:** Many wooden items will crack and warp or lose their finish.

**TIPS: Do not wash cutting boards, wooden salad bowls or knives with wooden handles in the dishwasher.**

**Pewter or pewter-like materials:** May streak, discolor, and pit.

**TIPS:** To keep pewter at its very best, hand wash with mild detergent.

### Dishwasher care & cleaning:

**Exterior** – Regular use of a soft damp cloth or sponge and a mild detergent is all that is necessary, in most cases, to keep the outside of your dishwasher nice looking and clean. **Interior** – Hard water minerals may cause a white film to build-up on the inside surfaces, especially just beneath the door area. Wear rubber gloves when cleaning the dishwasher interior. **Do not use any type of cleanser other than dishwasher detergent because it may cause foaming or sudsing.**

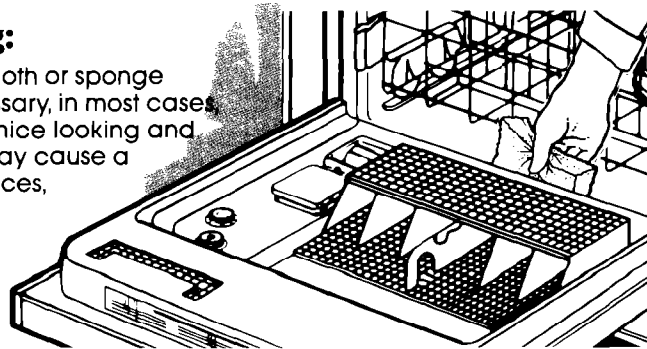

# Common dishwashing problems

PROBLEM	CAUSED BY	SOLUTION
<b>Spotting and filming</b>	Hard water	Fill detergent dispensers to capacity. Use dishwasher detergent with highest available phosphorus content. May be necessary to install water softener.  To remove spots and film, try a vinegar rinse... 1. Wash and rinse load as usual. Use AIR DRY. 2. Remove all metal items. 3. Put 2 cups (500 mL) white vinegar in a container on the bottom rack. 4. Run dishwasher through a complete washing cycle.
	Water is not hot enough	Water temperature should be at least 140°F (60°C). Set water heater thermostat to a higher setting. Run water at sink until hot before starting and/or use HI-TEMP WASH Option.
	Not enough detergent, or improper detergent "Old" detergent	Use more dishwasher detergent. Use detergent with highest available phosphorus content...especially with hard water.  Use only fresh dishwasher detergent. Store <b>tightly closed</b> container in cool, dry place. Discard old detergent. Do not fill dispensers until ready to start dishwasher.
	Improper loading	Make sure dishes and glassware are loaded so spray reaches all surfaces and items drain properly. Do not overload. Do not nest items.  Make sure large items do not block spray from reaching detergent dispensers.
	No rinse aid	Does the rinse aid dispenser need filling? See instructions on page 7.
	AIR DRY Setting used	Drying without heat may result in some spotting of glasses and silver.
<b>Small particles deposited on items</b>	Spray arm or arms not rotating freely "Old" detergent	Check spray arms to make sure they turn freely after loading. Be sure a utensil has not prevented their turning.  Use only fresh dishwasher detergent. Store <b>tightly closed</b> container in cool, dry place. Discard old detergent. Do not fill dispensers until ready to start dishwasher.
	Not enough detergent, or improper detergent	Use more dishwasher detergent. Use detergent with highest available phosphorus content...especially with hard water.
	Water is not hot enough	Water temperature should be at least 140°F (60°C). Set water heater thermostat to a higher setting. Run water at sink until hot before starting and/or use HI-TEMP WASH Option.
	Water pressure may be low, dishwasher is not filling properly	If water pressure is low, do not use water for other purposes while dishwasher is running (to assure correct fills).
<b>Dishes not dry</b>	Water is not hot enough	Water temperature should be at least 140°F (60°C). Set water heater thermostat to a higher setting. Run water at sink until hot before starting and/or use HI-TEMP WASH Option.
	Improper loading	Make sure dishes and glassware are loaded so spray reaches all surfaces and items drain properly. Do not overload. Do not nest items.
	No rinse aid AIR DRY Setting used	Fill rinse aid dispenser.  Allow more time when using AIR DRY Option, or use HEAT DRY. Plastic items may need towel drying.
<b>Black marks on dishes</b>	Aluminum utensils rubbing against items during washing	<b>Use care in loading aluminum utensils, especially any lightweight foil container. Place so they do not touch dishes.</b> Remove black marks with plastic scouring pad and a mild abrasive cleanser.
<b>Chipping or breaking glassware</b>	Improper loading	Do not overload. Load glasses in the top rack only. Load between prongs, not over them. Glasses loaded over prongs will not be supported and may chip or break.

PROBLEM	CAUSED BY	SOLUTION
<b>Dishes not washing clean</b>	Water is not hot enough	Water temperature should be at least 140°F (60°C). Set water heater thermostat to a higher setting. Run water at sink until hot before starting and/or use HI-TEMP WASH Option.
	Improper loading	Make sure dishes and glassware are loaded so spray reaches all surfaces and items drain properly. Do not overload. Do not nest items. Make sure large items do not block spray from reaching detergent dispensers.
	Spray arm or arms not rotating freely	Check spray arms to make sure they turn freely after loading. Be sure a utensil has not prevented their turning.
	Not enough detergent or improper detergent	Use more dishwasher detergent. Use detergent with highest available phosphorus content...especially with hard water.
	"Old" detergent	Use only fresh dishwasher detergent. Store <b>tightly closed</b> container in cool, dry place. Discard old detergent. Do not fill dispensers until ready to start dishwasher.
<b>Cloudy film on glassware, etching – permanent corrosion</b>	Water pressure may be low, dishwasher is not filling properly	If water pressure is low, do not use water for other purposes while dishwasher is running (to assure correct fills).
	Too much detergent in soft water	Check for rainbow hue on glasses. A rainbow hue is the first sign of etching (corrosion of glass). Reduce the amount of dishwasher detergent. Use a detergent with a lower phosphorus content.
<b>Dishes &amp; interior of dishwasher yellow or brown</b>	Inadequate rinsing	If water pressure is low do not use water for other purposes while dishwasher is running (to assure correct water fills). Make sure dishes and glassware are loaded properly to assure adequate rinsing and draining. Do not overload.
	Iron or manganese in water	<b>Temporary remedy:</b> 1. Set empty dishwasher for a "one wash" cycle. 2. Start dishwasher and unlatch door to stop it when it has filled for the wash part of the cycle. 3. Add ¼ to ½ cup (120 to 240 mL) of citric acid crystals (usually available in drugstores). 4. Close and latch door to complete cycle. <b>Permanent solution:</b> Install an iron or manganese filter to home water supply.
<b>Rust spots on stainless steel –OR- Dark spots on flatware – stainless steel, silver plate, or sterling</b>	Allowing salty or acidic foods such as mayonnaise, vinegar, fruit juices, salad dressings, milk products to remain on flatware.	Rinse flatware that is to stand for several hours before washing (use Rinse & Hold). Clean stained items with silver polish and re-wash. <b>Do not put stainless steel and silver flatware in the same silverware basket compartment. Direct contact between these metals can cause permanent damage to the silver.</b>
	Undissolved detergent coming in contact with flatware	Remove spots with silver polish. Avoid spilling concentrated detergent on wet flatware.
<b>Bronze tarnish on silverplate</b>	Silverplate is worn off. Exposed base metal takes on a bronzed hue.	Remove tarnish with silver polish. Have silver replated.
<b>Water left in bottom of dishwasher</b>	Dishwasher cycle not completed	Allow dishwasher to complete cycle.
	Clogged drain air gap	Some plumbing codes require use of a drain air gap between an <b>undercounter</b> dishwasher and the drain system of the house. The air gap is usually located above the sink or on the top of the counter near the dishwasher to prevent the possibility of water backing up from the drain into the dishwasher due to a plugged drain. The drain air gap is <b>NOT</b> a part of the dishwasher and is <b>NOT</b> covered by the dishwasher warranty. The drain air gap should be kept clean to ensure proper draining of the dishwasher.

# If you need service or assistance, we suggest you follow these five steps:

## 1. Before calling for assistance... 3. If you need service\*...

Performance problems often result from little things you can find and fix yourself without tools of any kind.

### If your dishwasher will not run, or stops during a cycle:

- Is the door tightly closed and securely latched?
- Has the cycle been correctly set?
- Is the water turned on?
- Have you checked your home's main fuses or circuit breaker box?
- Is the dishwasher wired into a live circuit with the proper voltage?
- If the motor has stopped because of an overload, it will automatically reset itself within a few minutes. If the motor does not start, call for service.

### If your dishwasher seems to run too long:

- Are you using POTS & PANS Cycle or HI-TEMP WASH Option? The dishwasher may be waiting for the water to heat.
- Is your household water temperature set too low? Low water temperature settings will cause longer dishwasher operating times.

### If water remains in the dishwasher:

- Has the cycle completed?
- A small amount of remaining water is normal.
- Is drain hose or air gap clogged?

### If detergent remains in the covered detergent cup:

- Is the bottom rack in backwards? (The rack bumpers should be at the front.)
- Is the dishwasher detergent fresh and dry without lumps?
- Is the cycle completed?

### If you hear grinding, grating, crunching, buzzing sounds:

- A hard object has probably entered the POWER CLEAN Module. The sound should stop when the object is ground up.

## 2. If you need assistance\*...

Call Whirlpool COOL-LINE® service assistance telephone number. Dial free from anywhere in the U.S.:

**1-800-253-4301**

and talk with one of our trained consultants. The consultant can instruct you in how to obtain satisfactory operation from your appliance or, if service is necessary, recommend a qualified service company in your area.



Whirlpool has a nationwide network of franchised TECH-CARE® Service Companies. TECH-CARE service technicians are trained to fulfill the product warranty and provide after-warranty service,

anywhere in the United States. To locate TECH-CARE service in your area, call our COOL-LINE service assistance telephone number (see Step 2) or look in your telephone directory Yellow Pages under:

APPLIANCES - HOUSEHOLD - MAJOR - SERVICE & REPAIR      ELECTRICAL APPLIANCES - MAJOR - REPAIRING & PARTS  
OR  
WASHING MACHINES, DRYERS & IRONERS - SERVICING  
WHIRLPOOL APPLIANCES FRANCHISED TECH-CARE SERVICE  
SERVICE COMPANIES  
XYZ SERVICE CO      999-9999  
123 Maple

## 4. If you have a problem\*...

Call our COOL-LINE service assistance telephone number (see Step 2) and talk with one of our consultants, or if you prefer, write to:

Mr. Donald Skinner  
Director of Customer Relations  
Whirlpool Corporation  
2000 M-63  
Benton Harbor, MI 49022

Please include a daytime phone number in your correspondence.

## 5. If you need FSP® replacement parts\*...

FSP is a registered trademark of Whirlpool Corporation for quality parts. Look for this symbol of quality whenever you need a replacement part for your Whirlpool appliance. FSP replacement parts will fit right and work right, because they are made to the same exacting specifications used to build every new Whirlpool appliance.

To locate FSP replacement parts in your area, refer to Step 3 above or call the Whirlpool COOL-LINE service assistance number in Step 2.

\*If you must call or write, please provide: model number, serial number, date of purchase, and a complete description of the problem. This information is needed in order to better respond to your request for assistance.

**POWER CLEAN\* WASHING SYSTEM  
PARTS COVERED BY YOUR  
WARRANTY**

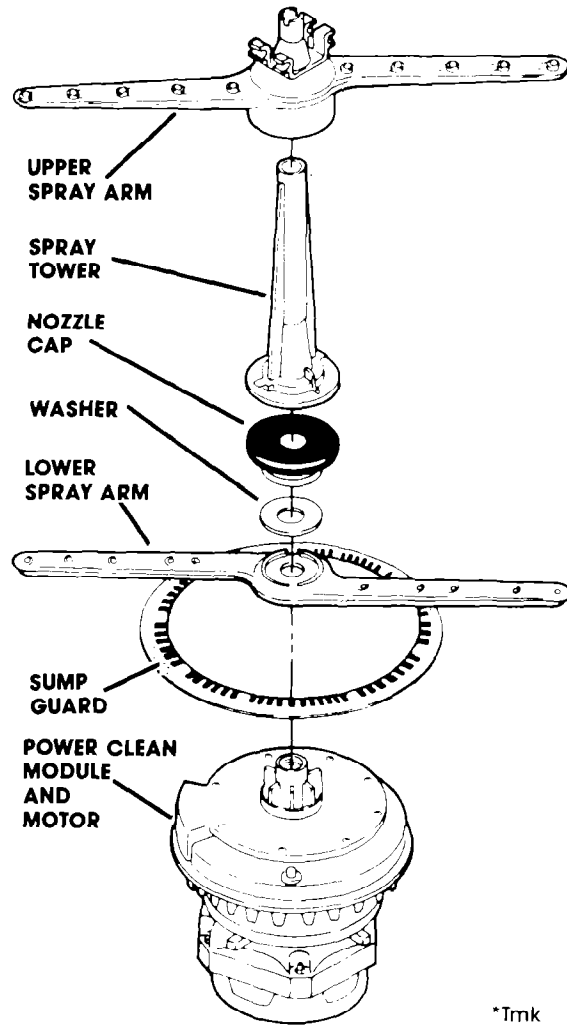

**IF YOU NEED SERVICE OR ASSISTANCE**

# WHIRLPOOL® DISHWASHER WARRANTY

DW003

LENGTH OF WARRANTY	WHIRLPOOL WILL PAY FOR
<b>FULL ONE-YEAR WARRANTY</b> From Date of Purchase	FSP® replacement parts and repair labor to correct defects in materials or workmanship. Service must be provided by a franchised TECH-CARE® service company.
<b>LIMITED ONE-YEAR WARRANTY</b> Second Year From Date of Purchase	FSP replacement parts for any part of the POWER CLEAN* Washing System if defective in materials or workmanship. These parts are shown on page 15 of this book.
<b>LIMITED NINE-YEAR WARRANTY</b> Second Through Tenth Year From Date of Purchase	FSP replacement of the porcelain tub and/or DURAPERM* inner door should they fail to contain water due to defective materials or workmanship.
<b>WHIRLPOOL WILL NOT PAY FOR</b>	
<p><b>A.</b> Service calls to:</p> <ol style="list-style-type: none"> <li>1. Correct the installation of the dishwasher.</li> <li>2. Instruct you how to use the dishwasher.</li> <li>3. Replace house fuses or correct house wiring or plumbing.</li> </ol> <p><b>B.</b> Repairs when dishwasher is used in other than normal, single-family household use.</p> <p><b>C.</b> Pick up and delivery. This product is designed to be repaired in the home.</p> <p><b>D.</b> Damage to dishwasher caused by accident, misuse, fire, flood, acts of God or use of products not approved by Whirlpool.</p> <p><b>E.</b> Any labor costs during limited warranties.</p>	

WHIRLPOOL CORPORATION SHALL NOT BE LIABLE FOR INCIDENTAL OR CONSEQUENTIAL DAMAGES. Some states do not allow the exclusion or limitation of incidental or consequential damages so this limitation or exclusion may not apply to you. This warranty gives you specific legal rights, and you may also have other rights which vary from state to state.

Outside the United States, a different warranty may apply. For details, please contact your franchised Whirlpool distributor or military exchange.

\*Tmk



Part No. 304290 Rev. B  
©1989 Whirlpool Corporation

Printed in U.S.A.

cers. Dishwashers. Built-in Ovens and Surface Units. Ranges. Microwave Ovens. Trash Compactors. Room Air Conditioners. Dehumidifiers. Automatic Washers. Clothes Dryers. Freezers. Refrigerator

