

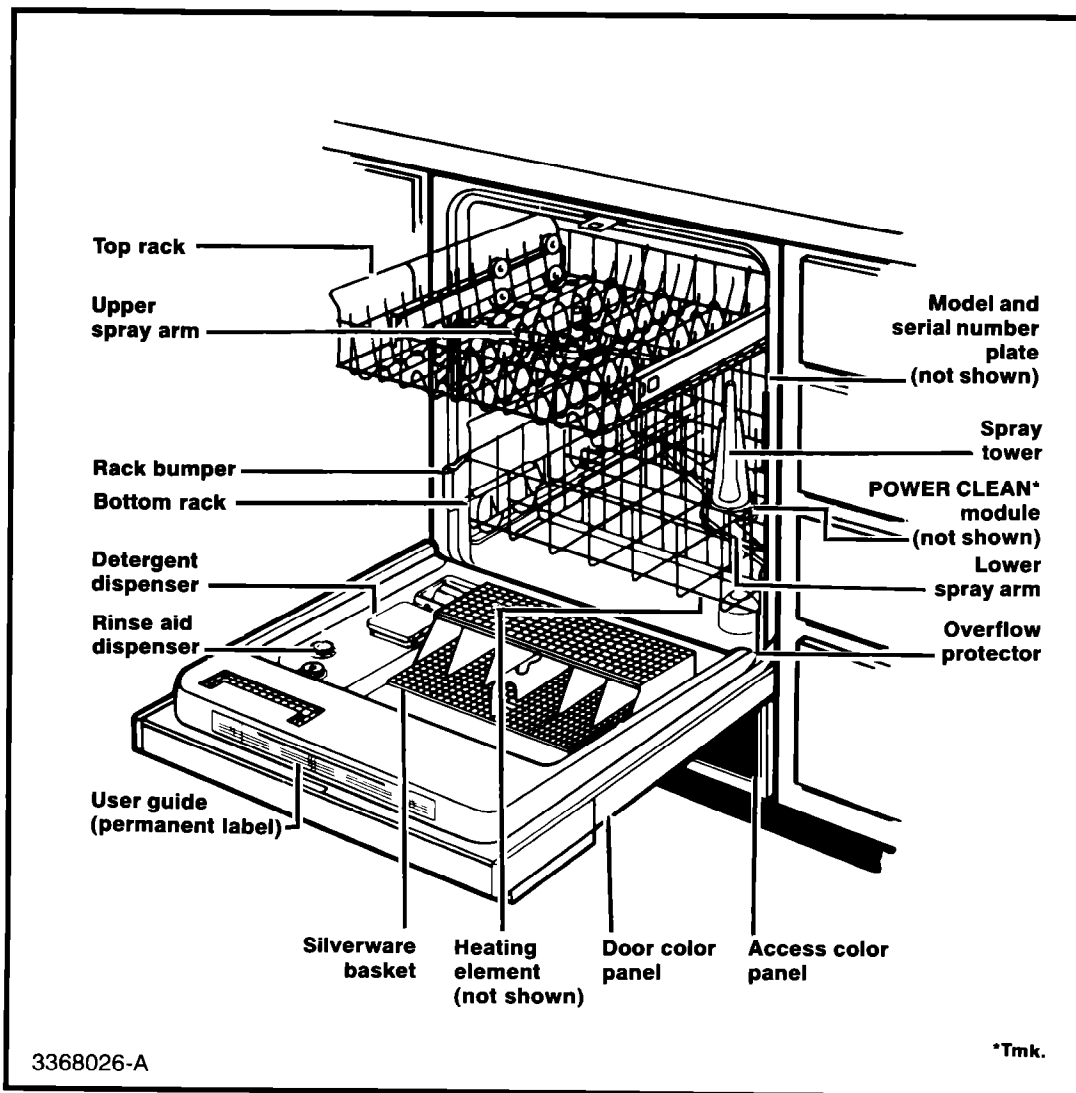

Use & Care Guide



UNDERCOUNTER DISHWASHER Model DU8550XT

Contents

	Page
Important Safety Instructions	3
Operating Instructions	3
Before starting your dishwasher	3
Starting your dishwasher	4
To add a dish after starting	4
Changing a cycle setting	4
Changing an option	4
What happens in each cycle	5
What happens in each option	6
Proper Loading	7
Adding Detergent and Rinse Aid	9
For Best Results	10
Special tips	10
Common Dishwashing Problems	12
If You Need Service Or Assistance	14
Whirlpool Dishwasher Warranty	16

©1988 Whirlpool Corporation

Thank you for buying a Whirlpool appliance. Please complete and mail the Owner Registration Card provided with this product.

Then complete the form below. Have this information ready if you need service or call with a question.

- Copy model and serial numbers from plate (see diagram on front cover) and purchase date from sales slip.
- Keep this book and sales slip together in a handy place.

Model Number

Serial Number

Purchase Date

Service Company Phone Number

It is your personal responsibility and obligation to be sure your dishwasher:

- Is installed by a qualified installer.
- Has been installed where it is protected from the elements.
- Has been installed on a floor strong enough to support its weight.
- Has been properly connected to electricity, water and drain.*
- Has been properly electrically grounded.*
- Has had all hang tags and temporary labels removed.
- Is not used by children or anyone unable to operate it properly.
- Is properly maintained.

*See Installation Instructions for complete information.

Important Safety Instructions

⚠ WARNING

To reduce the risk of fire, electrical shock, or injury when using your dishwasher, follow basic precautions including the following:

- **Read all instructions before using the dishwasher.**
- Properly connect to electricity and water.
- **DISHWASHER MUST BE ELECTRICALLY GROUNDED.** Read the Installation Instructions for details.
- Be sure your dishwasher is installed on a level floor that will hold the weight, and in an area suitable for its size and use.
- When discarding an old dishwasher, always remove the door to prevent accidental entrapment.
- **REMEMBER**, use your dishwasher only for the job it was designed to do.
- Store dishwasher detergent in a cool, dry place **WHERE CHILDREN CAN'T REACH IT.**
- Use **ONLY** detergents and rinse aids recommended for use in a dishwasher.
- Locate sharp items and knives so that they are not likely to damage door seal or cut the user.
- **DO NOT** let children play in or on the dishwasher.
- **DO NOT** reach into the area below the bottom rack until the heating element has cooled for at least 20 minutes.
- **DO NOT** wash plastic items unless marked "Dishwasher Safe" or the equivalent. If not marked, check manufacturer's recommendations.
- **DO NOT** use your dishwasher unless all enclosure panels are properly in place.
- **DO NOT** sit on, stand on or abuse the dishwasher door or dish racks.
- **DO NOT** tamper with controls.
- **If hot water has not been used recently (usually two weeks or longer), hydrogen gases may build up in the water heater and the hot water pipes. HYDROGEN GAS IS EXPLOSIVE. To prevent injury or damage, before using your dishwasher, turn on all hot water faucets and allow water to run for several minutes. This will allow gases to escape. Do not smoke or use any open flame near the faucet while it is open.**
- **Disconnect electrical power to the dishwasher before attempting to service.**

– SAVE THESE INSTRUCTIONS –

Operating Instructions

Before starting your dishwasher

1. Properly load the top and bottom racks, and silverware basket. See pages 7 and 8.
2. Spin the Upper and Lower Spray Arms with racks in place to make sure nothing will stop them from turning freely.
3. Add detergent.
4. Check rinse aid dispenser.
5. Push door firmly when closing and it will automatically latch.
6. Run hot water at sink nearest dishwasher until it is hot. Turn it off.

Operating Instructions Continued

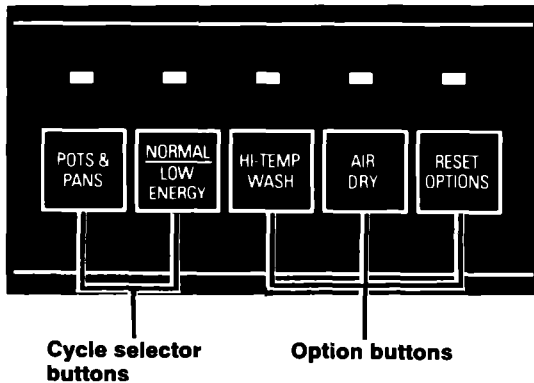

Starting your dishwasher

1. Push a Cycle Selector Button for the desired cycle. NORMAL WASH, LOW ENERGY WASH and RINSE & HOLD Cycles share the same button. The Cycle Control Knob determines which cycle operates.
2. Push an Option Selector Button for each desired option. (Use AIR DRY for RINSE & HOLD Cycle.)
3. Turn the Cycle Control Knob clockwise to point to a desired cycle. You will feel a definite stop at each cycle mark. The dishwasher will automatically start that cycle.

To add a dish after starting

1. To be sure the added item is washed and rinsed, make sure the Cycle Control Knob has not passed LOW ENERGY WASH.
2. Lift up on the door latch to unlatch door and stop the cycle. Don't open the door until the spray arms stop spinning.
3. Open the door and add the dish.
4. Close the door. **Do not latch it.** Wait 30 seconds for air in the dishwasher to warm up. This helps reduce the amount of moisture that can come from the vent when restarting the cycle.
5. Press door firmly to latch it. The dishwasher will automatically start where it stopped.

Changing a cycle setting

You can change a setting anytime during any cycle.

1. Lift up on the door latch to unlatch the door and stop the cycle. Don't open the door until the spray arms stop spinning.
2. Turn the Cycle Control Knob clockwise to the cycle you want.
3. Be sure the detergent dispensers are filled properly for the new cycle.
4. Push door firmly to latch it. The dishwasher will automatically start the new cycle.

Changing an option

If you want to change a selected option, push the RESET OPTIONS Button. Re-select an option, if desired.

What happens in each cycle

Pots & Pans Cycle

Maximum cleaning for cooked- or baked-on foods. Timer delays while the dishwasher automatically heats the water to 145°F (63°C) in both washes and the last rinse (marked *). Cycle time** will be about 1½ to 2 hours, depending on time needed to heat water.

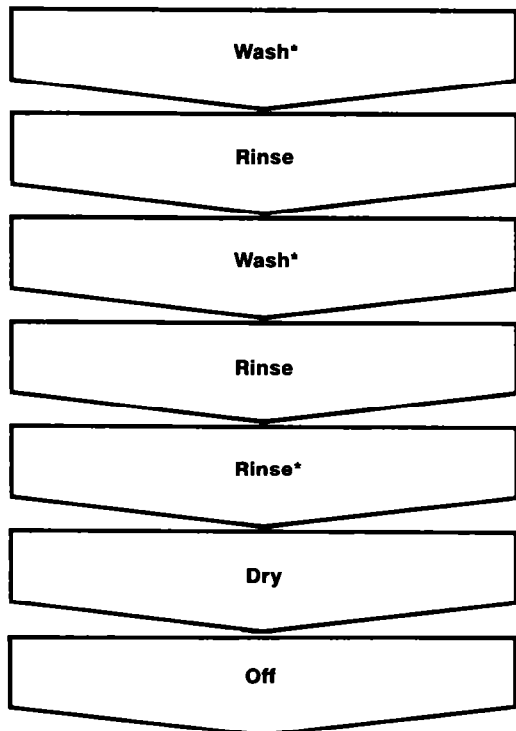
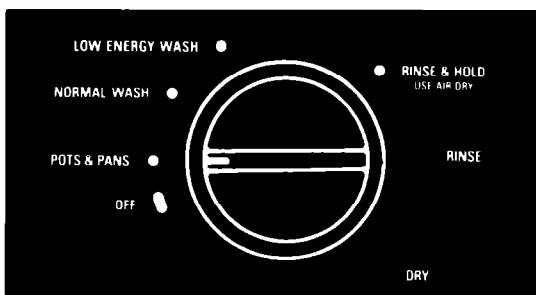

Normal Wash Cycle

For moderately soiled loads. (The Energy Guide Label data is based on this cycle.) Cycle time** is about 58 minutes plus the time needed to heat the water if the HI-TEMP WASH option is selected.

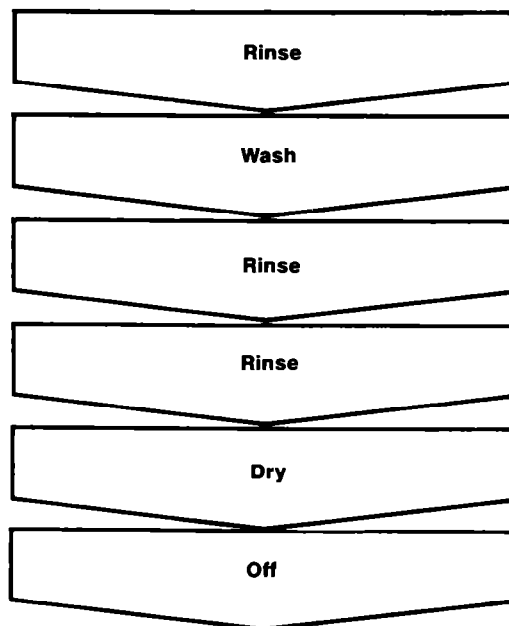
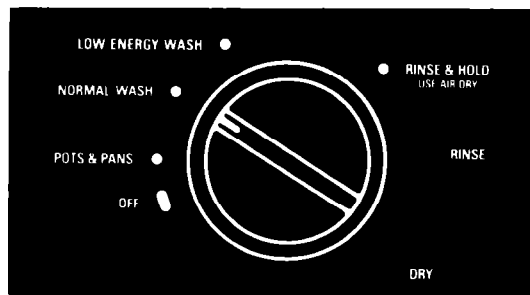

**Cycle time includes heated dry times.

Operating Instructions Continued

Low Energy Wash Cycle

For pre-rinsed or lightly soiled loads. Cycle time** is about 53 minutes plus the time needed to heat the water if the HI-TEMP WASH option is selected.

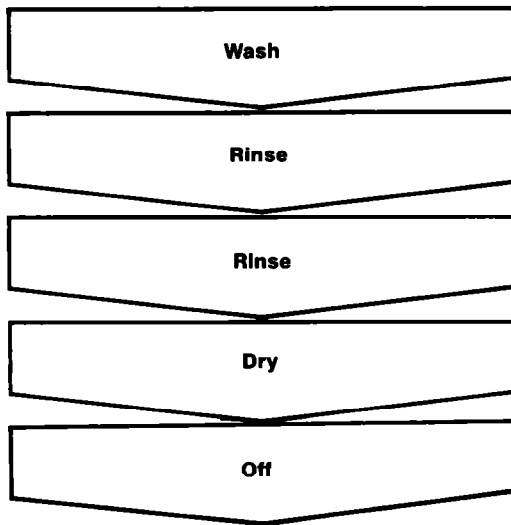
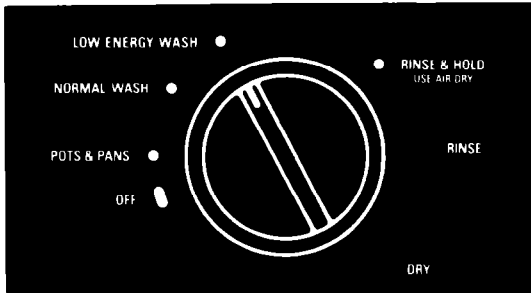

Rinse & Hold Cycle

For rinsing a few items to be washed one or more days later. Cycle time is about 12 minutes. Use AIR DRY only. Do not use detergent.

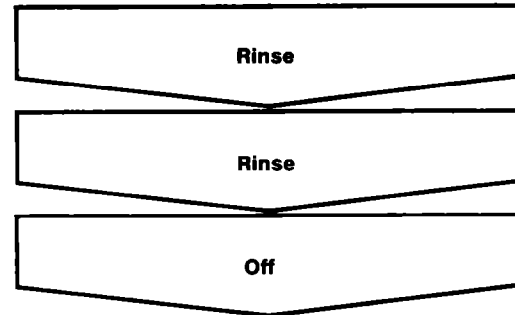
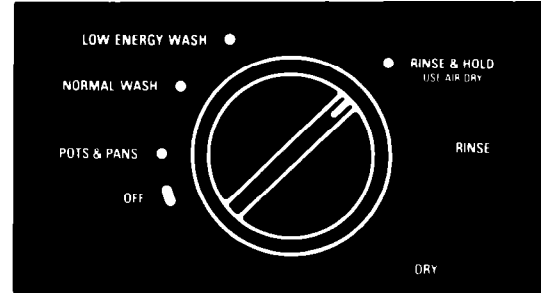

**Cycle time includes heated dry times.

What happens in each option

Hi-Temp Wash

When this option is selected, water for the main wash and the final rinse is heated (except in the RINSE & HOLD Cycle) to 145°F (63°C).

If water is already hot enough, the cycle continues without delay.

Air Dry

Air in the dishwasher is automatically heated during the "dry" part of all cycles.

If the AIR DRY Option is selected, air in the dishwasher is not heated. Using this option helps save energy, but dishes take longer to dry (overnight) and some water spotting may result. Some items (such as plastics) may need towel drying.

For best results, use a liquid rinse aid such as Jet-Dry.®

Proper Loading

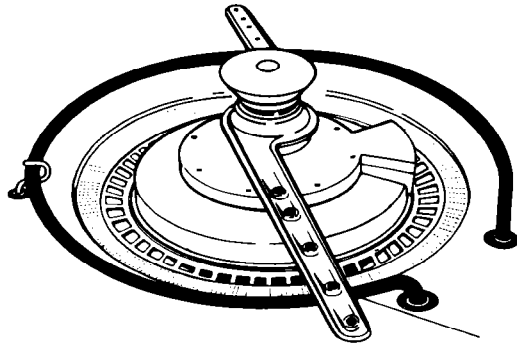

Preparation for loading

It is not necessary to rinse dishes before putting them into the dishwasher. Just remove large pieces, bones and other hard items. The POWER CLEAN* Module will remove food particles from the water. It contains a chopping device which will reduce the size of food items.

If hard items such as fruit seeds, nuts and egg shells enter the POWER CLEAN* Module, you might hear chopping, grinding, crunching or buzzing sounds. Those sounds are normal when hard items enter the module. **Do not** let metallic items (i.e. pot handle screws) get into the POWER CLEAN* Module. This could result in damage to the POWER CLEAN* Module.

Always load dishes so soiled surfaces are reached by spray from rotating spray arms. Water must be able to drain off completely for best drying results. Be careful to separate items so spray can reach all surfaces.

*Tmk.

Top rack loading

The top rack is designed for cups, glasses and smaller items.

Cup and glass load

- Place so open ends face down for cleaning and draining.
- **Load glasses in top rack only.** Bottom rack is not designed for glasses. Damage may occur.
- Place items in the rows **between** prongs. Placing them **over** the prongs can lead to breakage.
- Be sure lightweight items are held firmly in place.
- China, crystal and other delicate items must not touch each other during dishwasher operation. Damage may occur.

Mixed load

- Load plastic items **only in the top rack.** Only plastic items marked "dishwasher safe" are recommended.
- Plastic items can be melted in the bottom rack.

Utensil load

- Small bowls, pans and other utensils can be placed in the top rack.

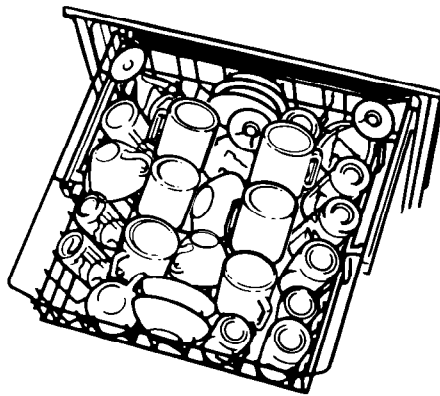

Cup and glass load

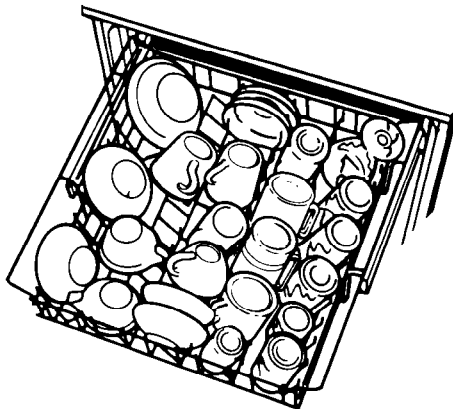

Mixed load

Proper Loading Continued

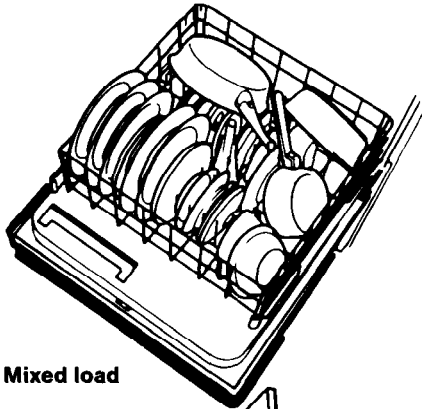

Mixed load

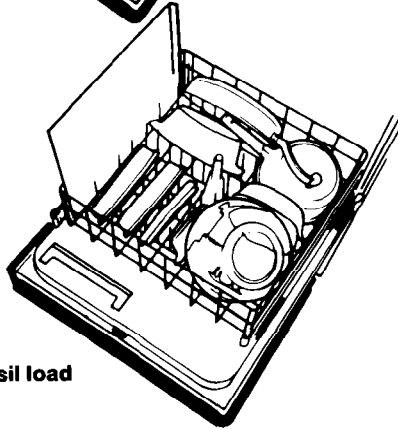

Utensil load

Bottom rack loading

Items with cooked-on or dried-on food should be loaded in the bottom rack, with soiled surfaces facing inward to the spray.

Mixed load

- Make sure pot handles and other items do not stop rotation of either the upper or lower spray arm. Spray arms must move freely.
- Securely place heavily soiled cookware face down in rack.

Dish load

- Place plates, soup bowls, etc., **between** prongs and facing inward to the spray.
- Do not place items directly over spray tower.

Utensil load

- Load cookie sheets, cake pans and other large items at sides and back. Loading such items in front may keep water spray from reaching detergent dispenser.

NOTE:

- Do not load glasses, cups or plastic items in the bottom rack.
- When lower rack is removed, replace with bumpers in front.

Silverware basket loading

Load forks and spoons so they **don't nest together**. Spray can't reach nested items.

Mix items in each section of the basket. Small items – baby bottle caps, jar lids, etc. – can be put in any section.

The silverware basket can be loaded while it's in place on the door, or it can be taken out for loading on the counter or table.

It can also be removed for easy unloading.

Always unload or remove the basket before unloading the racks to avoid spilling water droplets on the silverware.

To remove the basket, slide it toward the top of the door – by the handle. Lift it off the holding buttons. Replace it in reverse order.

To open the basket, unhook the latch as shown. Be sure the cover is completely latched before pulling out the bottom rack and before closing the dishwasher door.

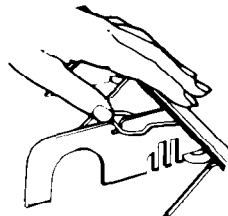
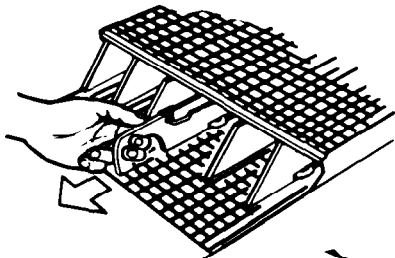
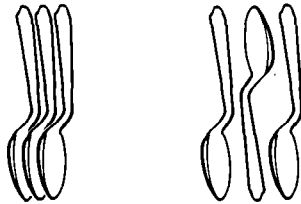

⚠ WARNING

To avoid cuts from sharp items (knives, forks, skewers, etc.), make sure these items are put in point down.

Adding Detergent And Rinse Aid

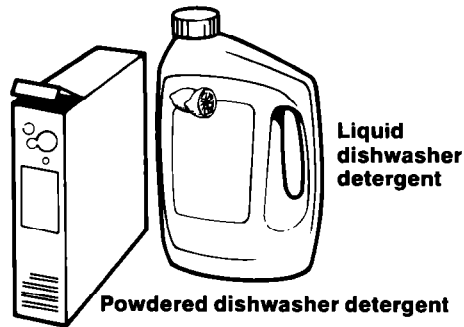

See phosphorus content on product labels.

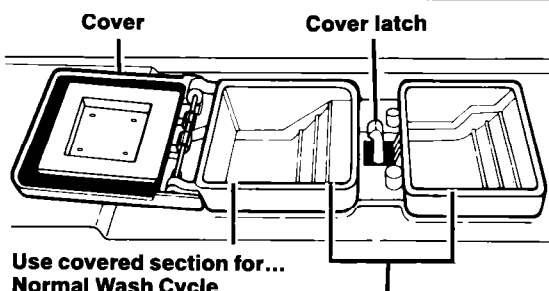

Use covered section for...
Normal Wash Cycle
Low Energy Wash Cycle

Use both sections for...
Pots & Pans Cycle

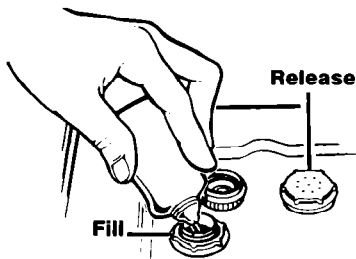
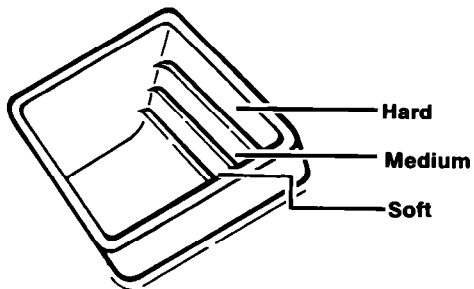

What kind of detergent to use

Use automatic dishwasher detergent only.

Other detergents are too mild and much too sudsy to work in the dishwasher.

Different brands of dishwasher detergent have different amounts of phosphorus for softening water. If water is hard and phosphorus content is low (6.0% or less), you may need to use more detergent or use a brand with a higher phosphorus content (8.7% or higher).

Do not add detergent until you are ready to wash. **Fresh automatic dishwasher detergent is necessary for best washing results.**

Store detergent tightly closed in a cool, dry place.

The detergent dispenser

The detergent dispenser has one section with a cover and one without.

- Put detergent in both sections for cycles with two washes.
- Put detergent in the covered section only for cycles with one wash.
- Push the cover down until it is latched.

The cover opens automatically when the main wash starts. Detergent in the open section falls into the dishwasher when the door is closed.

How much detergent to use

The amount of detergent to use depends on the hardness of your water. If too little is used, dishes won't be clean. However, if too much is used in soft water, glassware will begin to etch.

Find out your water's hardness by asking your local water department, water softener company or county extension agent.

- **HARD** – Fill 1 or both sections to top line if water hardness is 8 or more grains per gallon, or 136 or more parts per million.
- **MEDIUM** – Fill 1 or both sections to middle line if water hardness is 5 to 7 grains per gallon, or 85 to 119 parts per million.
- **SOFT** – Fill 1 or both sections to bottom line if water hardness is 0 to 4 grains per gallon, or 0 to 68 parts per million.

Rinse aid dispenser

A rinse aid helps keep water from forming droplets and drying as spots. Keep the dispenser filled with a rinse aid such as Jet-Dry.[®] A small amount is released automatically during the final rinse of each cycle.

Check the dispenser periodically to see if it needs refilling. An "E" will be visible inside dispenser when it is empty. Make sure dishwasher door is fully open when refilling. Do not fill past the smallest opening in the lower part of the dispenser. Keep the dispenser fill cap tightly closed.

For Best Results

Hot water is a must

Hot water dissolves and activates the dishwashing detergent. Hot water dissolves grease on dishes and helps dry glasses spot-free. Make certain loads are washed in hot water (at least 140°F – 60°C). Two ways to have a reliable hot water supply...

1. Maintain 140°F water supply at central water heater. To check water temperature, turn on hot water faucet nearest the dishwasher. Let water run until it is as hot as possible, then check with a candy or meat thermometer. If the temperature is too low, have a qualified person raise the water heater thermostat setting.
2. Use HI-TEMP WASHING Option. If water heating is needed, a thermostat will delay the cycle until temperature reaches 145°F (63°C). If water is hot enough, the cycle will proceed with no delay. This lets you turn down your water heater, if you choose, without cutting back on hot water needed for good dishwashing.

Quiet operating tips

To avoid thumping and clattering noises during operation:

- Make sure lightweight load items are secured in the rack.
- Make sure pot lids and handles, pizza pans, cookie sheets, etc. do not touch interior walls or interfere with either of the spray arms rotation.
- Load dishes so they **don't** touch one another.

NOTE: Keep sink drain plugs inserted during dishwasher operation to prevent noise transfer through drains.

Special tips

Remember, use your dishwasher only for the job it was designed to do. Some items are not dishwasher safe or may require special care. Read these special tips for the following items:

Aluminum: Aluminum loses its bright, shiny appearance and darkens in color due to minerals in the water and the alkalinity of the dishwasher detergent. Colored aluminum may fade.

TIPS: If washed in the dishwasher avoid placing directly in front of detergent dispenser where it could be sprinkled with undissolved detergent, causing spotting, pitting, and discoloration. Follow utensil manufacturers' cleaning instructions.

China: Hand-painted, metal-trimmed, and antique china fade due to high water temperatures and alkaline detergent solution in the dishwasher.

NOTE: Delicate, antique items should not be washed in the dishwasher.

TIPS: Load china carefully. **Do not** allow pieces to touch each other. Test one piece by washing it daily in the dishwasher for several weeks. Then compare it with the rest of the set to see if colors have changed.

Crystal and decorative glasses: Crystal can break from sudden exposure to high water temperature. Metal trim and colorful decoration on glass will fade in time when washed in the dishwasher.

NOTE: Delicate, antique items should not be washed in the dishwasher.

TIPS: Load crystal carefully in **top rack only**. Be sure to load a few larger items in the bottom rack to reduce amount of force of water spray reaching glassware from lower spray arm. Use the shortest cycle.

Flatware: Salty and acidic food may tarnish silver and stainless flatware if allowed to remain on the utensils. A film may form on sterling silver and silver plate items washed in a dishwasher. This film is caused by reaction of silver with chlorine in the detergent. **Gold flatware is not dishwasher safe.** The adhesive used in some flatware with hollow handles is not heat resistant, causing the handles to come off in the dishwasher. Wash by hand.

TIPS: Rinse flatware as soon as possible, especially if it is not to be washed right away. Dishwasher detergent may remove antique finishes. Wash by hand. Tarnish and film build-up can be removed with silver polish.

Cast iron utensils: The seasoned finish will be removed in the dishwasher. Rusting will result.

TIPS: Wash by hand. To re-season, coat with unsalted fat and heat in a slow oven for an hour or two.

Plastics: Many plastics will have "Dishwasher Safe" written on them. Some plastics are heat sensitive and may melt or warp.

TIPS: If in doubt, try one piece. Place in upper rack only. AIR DRY option provides additional protection.

Non-stick finish utensils: Most can be washed in the dishwasher.

TIPS: Follow manufacturers' suggestions.

Wood: Many wooden items will crack and warp or lose their finish.

TIPS: **Do not** wash cutting boards, wooden salad bowls or knives with wooden handles in the dishwasher.

Pewter or pewter-like materials: May streak, discolor, and pit.

TIPS: To keep pewter at its very best, hand wash with mild detergent.

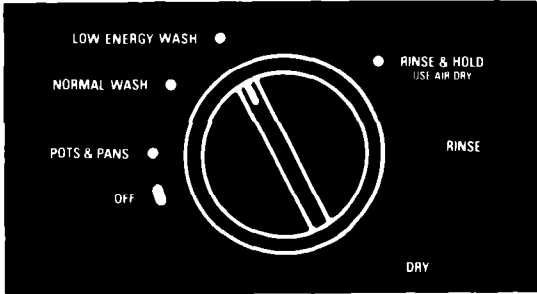

Energy saving tips

You can help save energy if you:

1. **Wash full loads.** Running a half-filled dishwasher uses the same amount of electricity and hot water as a fully loaded machine.
2. Use the **LOW ENERGY WASH Cycle** whenever possible. It uses less hot water and energy than other wash cycles.
3. **Air dry dishes** when you don't need a rapid drying cycle. Allow longer drying times (overnight).
4. **Load correctly** for best washing results. Incorrect loading may cause poor washing and the need to rewash all or part of the load.
5. **Don't pre-rinse normally soiled dishes.** Select the correct cycle for the load and use the recommended amount of detergent for good washing results without hand rinsing.
6. **Use your dishwasher** during off-peak hours. Local utilities recommend this to avoid heavy usage of energy at certain times of day.

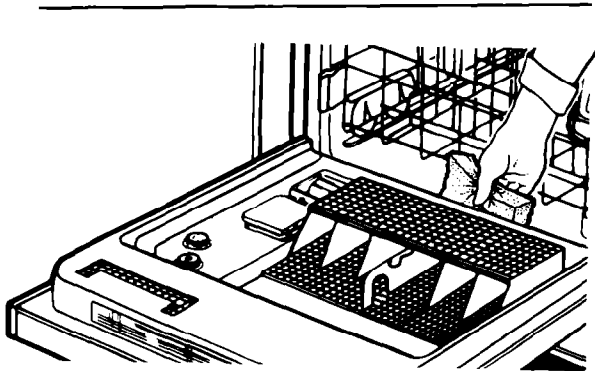

Dishwasher care & cleaning

Exterior – Regular use of a soft damp cloth or sponge and a mild detergent is all that is necessary, in most cases, to keep the outside of your dishwasher nice looking and clean. **Interior** – Hard water minerals may cause a white film to build-up on the inside surfaces, especially just beneath the door area. Wear rubber gloves when cleaning the dishwasher interior. **Do not** use any type of cleanser other than dishwasher detergent because it may cause foaming or sudsing.

Common Dishwashing Problems

Spotting and filming (hard water film)

Hard water

Fill detergent dispensers to capacity. Use dishwasher detergent with highest available phosphorus content. May be necessary to install water softener.

To remove spots and film, try a vinegar rinse...

1. Wash and rinse load as usual. Use AIR DRY.
2. Remove all metal items.
3. Put 2 cups (500 mL) white vinegar in a container on the bottom rack.
4. Run dishwasher through a complete washing cycle.

Water is not hot enough

Water temperature should be at least 140°F (60°C). Set water heater thermostat to a higher setting. Run water at sink until hot before starting and/or use HI-TEMP WASH Option.

Not enough detergent, or improper detergent

Use more dishwasher detergent. Use detergent with highest available phosphorus content...especially with hard water.

“Old” detergent

Use only fresh dishwasher detergent. Store **tightly closed** container, in cool, dry place. Discard old detergent. Do not fill dispensers until ready to start dishwasher.

Improper loading

Make sure dishes and glassware are loaded so spray reaches all surfaces and items drain properly. Do not overload. Do not nest items. Make sure large items do not block spray from reaching detergent dispensers.

No rinse aid

Does the rinse aid dispenser need filling? See instructions on page 9.

AIR DRY Setting used

Drying without heat may result in some spotting of glasses and silver.

Small particles deposited on items

Spray arm or arms not rotating freely

Check spray arms to make sure they turn freely after loading. Be sure a utensil has not prevented their turning.

“Old” detergent

Use only fresh dishwasher detergent. Store **tightly closed** container, in cool, dry place. Discard old detergent. Do not fill dispensers until ready to start dishwasher.

Not enough detergent, or improper detergent

Use more dishwasher detergent. Use detergent with highest available phosphorus content... especially with hard water.

Water is not hot enough

Water temperature should be at least 140°F (60°C). Set water heater thermostat to a higher setting. Run water at sink until hot before starting and/or use HI-TEMP WASH Option.

Water pressure may be low, dishwasher is not filling properly

If water pressure is low, do not use water for other purposes while dishwasher is running (to assure correct fills).

Dishes not dry

Water is not hot enough

Water temperature should be at least 140°F (60°C). Set water heater thermostat to a higher setting. Run water at sink until hot before starting and/or use HI-TEMP WASH Option.

Improper loading

Make sure dishes and glassware are loaded so spray reaches all surfaces and items drain properly. Do not overload. Do not nest items.

No rinse aid

Does the rinse aid dispenser need filling? See instructions on page 9.

AIR DRY Setting used

Allow more time when using AIR DRY Option, or use HEAT DRY. Plastic items may need towel drying.

Black marks on dishes

Aluminum utensils rubbing against items during washing

Use care in loading aluminum utensils, especially any lightweight foil container. Place so they do not touch dishes. Remove black marks with plastic scouring pad and a mild abrasive cleanser.

Chipping or breaking glassware

Improper loading

Do not overload. Load glasses in the top rack only. Load between prongs, not over them. Glasses loaded over prongs will not be supported and may chip or break.

Dishes not washing clean

Water is not hot enough

Water temperature should be at least 140°F (60°C). Set water heater thermostat to a higher setting. Run water at sink until hot before starting and/or use HI-TEMP WASH Option.

Improper loading

Make sure dishes and glassware are loaded so spray reaches all surfaces and items drain properly. Do not overload. Do not nest items.

Make sure large items do not block spray from reaching detergent dispensers.

Spray arm or arms not rotating freely

Check spray arms to make sure they turn freely after loading. Be sure a utensil has not prevented their turning.

Not enough detergent or improper detergent

Use more dishwasher detergent. Use detergent with highest available phosphorus content... especially with hard water.

“Old” detergent

Use only fresh dishwasher detergent. Store **tightly closed** container, in cool, dry place. Discard old detergent. Do not fill dispensers until ready to start dishwasher.

Water pressure may be low, dishwasher is not filling properly

If water pressure is low, do not use water for other purposes while dishwasher is running (to assure correct fills).

Cloudy film on glassware, etching – permanent corrosion

Too much detergent in soft water

Check for rainbow hue on glasses. A rainbow hue is the first sign of etching (corrosion of glass). Reduce the amount of dishwasher detergent. Use a detergent with a lower phosphorus content.

Inadequate rinsing

If water pressure is low do not use water for other purposes while dishwasher is running (to assure correct water fills). Make sure dishes and glassware are loaded properly to assure adequate rinsing and draining. Do not overload.

Dishes & interior of dishwasher yellow or brown

Iron or manganese in water

Temporary remedy:

1. Set empty dishwasher for a "one wash" cycle.
2. Start dishwasher and unlatch door to stop it when it has filled for the wash part of the cycle.

3. Add ¼ to ½ cup (120 to 240 mL) of citric acid crystals (usually available in drugstores).

4. Close and latch door to complete cycle.

Permanent solution: Install an iron or manganese filter to home water supply.

Rust spots on stainless steel – OR – Dark spots on flatware: stainless steel, silver plate, or sterling

Allowing salty or acidic foods such as mayonnaise, vinegar, fruit juices, salad dressings, milk products to remain on flatware

Rinse flatware that is to stand for several hours before washing (use Rinse & Hold). Clean stained items with silver polish and re-wash. **Do not** put stainless steel and silver flatware in the same silverware basket compartment. Direct contact between these metals can cause permanent damage to the silver.

Undissolved detergent coming in contact with flatware

Remove spots with silver polish. Avoid spilling concentrated detergent on wet flatware.

Bronze tarnish on silverplate

Silverplate is worn off. Exposed base metal takes on a bronzed hue

Remove tarnish with silver polish. Have silver replated.

Water left in bottom of dishwasher

Dishwasher cycle not completed

Allow dishwasher to complete cycle.

Clogged drain air gap

Some plumbing codes require use of a drain air gap between an **undercounter** dishwasher and the drain system of the house. The air gap is usually located above the sink or on the top of the counter near the dishwasher to prevent the possibility of water backing up from the drain into the dishwasher due to a plugged drain. The drain air gap is **not** a part of the dishwasher and is **not** covered by the dishwasher warranty. The drain air gap should be kept clean to insure proper draining of the dishwasher.

If You Need Service Or Assistance

We suggest you follow these five steps:

1. Before calling for assistance...

Performance problems often result from little things you can find and fix yourself without tools of any kind.

If your dishwasher will not run, or stops during a cycle:

- Is the door tightly closed and securely latched?
- Has the cycle been correctly set?
- Is the water turned on?
- Have you checked your home's main fuses or circuit breaker box?
- Is the dishwasher wired into a live circuit with the proper voltage?
- If the motor has stopped because of an overload, it will automatically reset itself within a few minutes. If the motor does not start, call for service.

If your dishwasher seems to run too long:

- Are you using POTS & PANS Cycle? The dishwasher may be waiting for the water to heat.
- Is your household water temperature set too low? Low water temperature settings will cause longer dishwasher operating times.

If water remains in the dishwasher:

- Has the cycle completed?
- A small amount of remaining water is normal.
- Is drain air gap clogged?

If detergent remains in the covered detergent cup:

- Is the bottom rack in backwards? (The rack bumpers should be at the front.)
- Is the dishwasher detergent fresh?
- Is the cycle completed?

If you hear grinding, grating, crunching, buzzing sounds:

A hard object has probably entered the POWER CLEAN Module. The sound should stop when the object is ground up.

2. If you need assistance*..

Call Whirlpool COOL-LINE® service assistance telephone number. Dial free from anywhere in the U.S.:

1-800-253-1301

and talk with one of our trained consultants. The consultant can instruct you in how to obtain satisfactory operation from your appliance or, if service is necessary, recommend a qualified service company in your area.

3. If you need service*..



Whirlpool has a nationwide network of franchised TECH-CARE® Service Companies. TECH-CARE service technicians are trained to fulfill the product warranty and provide after-warranty service, anywhere in the United States. To locate TECH-CARE service in your area, call our COOL-LINE service assistance telephone number (see Step 2) or look in your telephone directory Yellow Pages under:

APPLIANCES - HOUSEHOLD - MAJOR - SERVICE & REPAIR ELECTRICAL APPLIANCES - MAJOR - REPAIRING & PARTS
OR
WASHING MACHINES, DRYERS & IRONERS - SERVICING
WHIRLPOOL APPLIANCES FRANCHISED TECH-CARE SERVICE
SERVICE COMPANIES
XYZ SERVICE CO
123 MAPLE 999-9999

4. If you have a problem*..

Call our COOL-LINE service assistance telephone number (see Step 2) and talk with one of our consultants, or if you prefer, write to:

Mr. Donald Skinner
Director of Customer Relations
Whirlpool Corporation
2000 M-63
Benton Harbor, MI 49022

5. If you need FSP® replacement parts*..

FSP is a registered trademark of Whirlpool Corporation for quality parts. Look for this symbol of quality whenever you need a replacement part for your Whirlpool appliance. FSP replacement parts will fit right and work right, because they are made to the same exacting specifications used to build every new Whirlpool appliance.

To locate FSP replacement parts in your area, refer to Step 3 above or call the Whirlpool COOL-LINE service assistance number in Step 2.

*If you must call or write, please provide: model number, serial number, date of purchase, and a complete description of the problem. This information is needed in order to better respond to your request for assistance.

**POWER CLEAN® washing system parts
covered by your warranty**

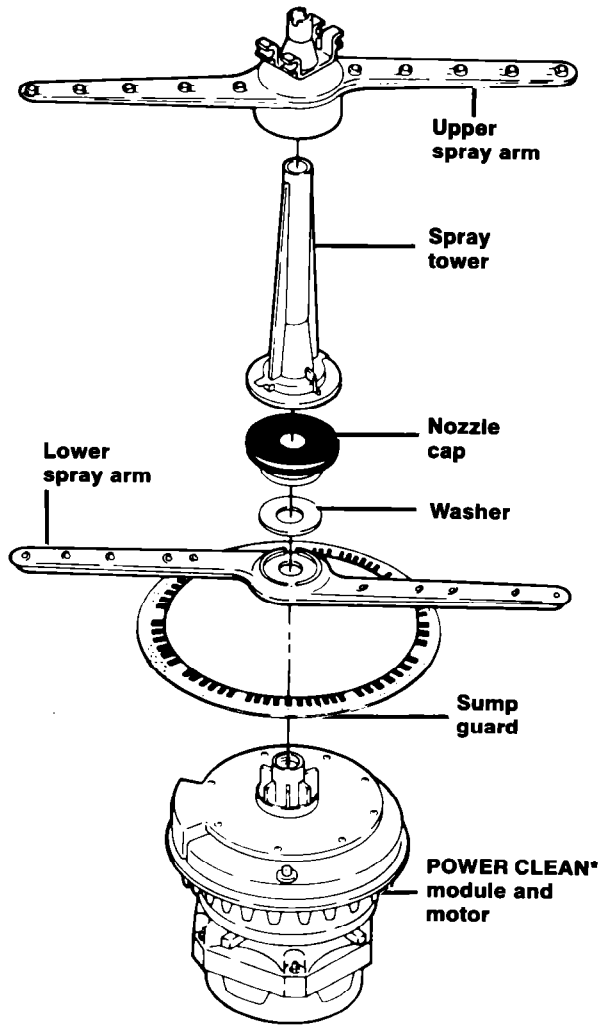

*Tmk

IF YOU NEED SERVICE OR ASSISTANCE

Whirlpool® Dishwasher Warranty

DW003

LENGTH OF WARRANTY	WHIRLPOOL WILL PAY FOR
FULL ONE-YEAR WARRANTY From Date of Purchase	FSP® replacement parts and repair labor to correct defects in materials or workmanship. Service must be provided by a franchised TECH-CARE® service company.
LIMITED ONE-YEAR WARRANTY Second Year From Date of Purchase	FSP replacement parts for any part of the POWER CLEAN* Washing System if defective in materials or workmanship. These parts are shown on page 15 of this book.
LIMITED NINE-YEAR WARRANTY Second Through Tenth Year From Date of Purchase	FSP replacement of the porcelain tub and/or DURAPERM* inner door should they fail to contain water due to defective materials or workmanship.
WHIRLPOOL WILL NOT PAY FOR	
<p>A. Service calls to:</p> <ol style="list-style-type: none">1. Correct the installation of the dishwasher.2. Instruct you how to use the dishwasher.3. Replace house fuses or correct house wiring or plumbing. <p>B. Repairs when dishwasher is used in other than normal, single-family household use.</p> <p>C. Pick up and delivery. This product is designed to be repaired in the home.</p> <p>D. Damage to dishwasher caused by accident, misuse, fire, flood, acts of God or use of products not approved by Whirlpool.</p> <p>E. Any labor costs during limited warranties.</p>	

WHIRLPOOL CORPORATION SHALL NOT BE LIABLE FOR INCIDENTAL OR CONSEQUENTIAL DAMAGES. Some states do not allow the exclusion or limitation of incidental or consequential damages so this limitation or exclusion may not apply to you. This warranty gives you specific legal rights, and you may also have other rights which vary from state to state.

Outside the United States, a different warranty may apply. For details, please contact your franchised Whirlpool distributor or military exchange.

*Tmk.

