

Micro Hi-Fi Component System

Operating Instructions

Owner's Record

The model and serial numbers are located on the bottom. Record the serial number in the space provided below. Refer to them whenever you call upon your Sony dealer regarding this product.

Model No. _____ Serial No. _____



CMT-EP50

WARNING

To prevent fire or shock hazard, do not expose the unit to rain or moisture.

To avoid electrical shock, do not open the cabinet. Refer servicing to qualified personnel only.

Do not install the appliance in a confined space, such as a bookcase or built-in cabinet.

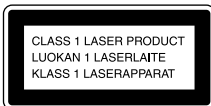

To prevent fire, do not cover the ventilation of the apparatus with newspapers, table-cloths, curtains, etc. And don't place lighted candles on the apparatus.

To prevent fire or shock hazard, do not place objects filled with liquids, such as vases, on the apparatus.



Don't throw a battery, dispose it as the injurious wastes.

NOTICE FOR THE CUSTOMERS IN THE U.S.A.

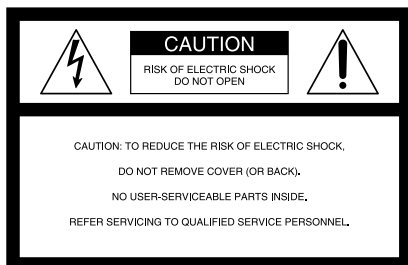

This symbol is intended to alert the user to the presence of uninsulated "dangerous voltage" within the product's enclosure that may be of sufficient magnitude to constitute a risk of electric shock to persons.



This symbol is intended to alert the user to the presence of important operating and maintenance (servicing) instructions in the literature accompanying the appliance.

CAUTION

The use of optical instruments with this product will increase eye hazard.

INFORMATION

This equipment has been tested and found to comply with the limits for a Class B digital device, pursuant to Part 15 of the FCC Rules. These limits are designed to provide reasonable protection against harmful interference in a residential installation. This equipment generates, uses, and can radiate radio frequency energy and, if not installed and used in accordance with the instructions, may cause harmful interference to radio communications. However, there is no guarantee that interference will not occur in a particular installation. If this equipment does cause harmful interference to radio or television reception, which can be determined by turning the equipment off and on, the user is encouraged to try to correct the interference by one or more of the following measures:

- Reorient or relocate the receiving antenna.
- Increase the separation between the equipment and receiver.
- Connect the equipment into an outlet on a circuit different from that to which the receiver is connected.
- Consult the dealer or an experienced radio/TV technician for help.

CAUTION

You are cautioned that any changes or modifications not expressly approved in this manual could void your authority to operate this equipment.

Note to CATV system installer:

This reminder is provided to call the CATV system installer's attention to Article 820-40 of the NEC that provides guidelines for proper grounding and, in particular, specifies that the cable ground shall be connected to the grounding system of the building, as close to the point of cable entry as practical.

NOTICE FOR THE CUSTOMERS IN CANADA

CAUTION

TO PREVENT ELECTRIC SHOCK, DO NOT USE THIS POLARIZED AC PLUG WITH AN EXTENSION CORD, RECEPTACLE OR OTHER OUTLET UNLESS THE BLADES CAN BE FULLY INSERTED TO PREVENT BLADE EXPOSURE.

Table of Contents

Parts Identification

Main unit	4
Remote Control	5

Getting Started

Hooking up the system	6
Inserting two size AAA (R03) batteries into the remote	7
Setting the time	7

CD

Loading the CD	8
Playing the CD — Normal Play/Shuffle Play/Repeat Play	8
Programing the CD tracks — Program Play	9
Using the CD display	9

Tuner

Presetting radio stations	10
Listening to the radio — Preset Tuning	11
Using the Radio Data System (RDS)*	11

Tape

Loading a tape	13
Playing a tape	13
Recording to a tape — CD Synchro Recording/Recording Manually	14
Timer-recording radio programs	15

Sound Adjustment

Adjusting the sound	16
Selecting the audio emphasis	16

Other features

Falling asleep to music — Sleep Timer	17
Waking up to music — Daily Timer	17

Additional information

Precautions	19
Troubleshooting	20
Specifications	22

* For European model only

The items are arranged in alphabetical order.

Refer to the pages indicated in parentheses () for details.

Main unit

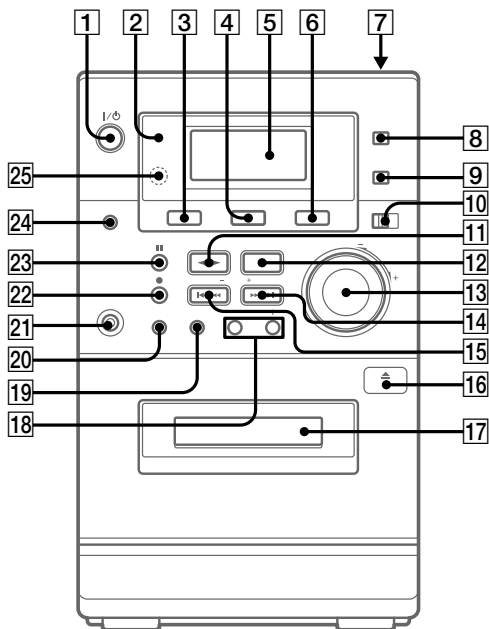

Cassette compartment **17** (13)
 CD **4** (8, 9, 14)
 DISPLAY **24** (9, 11)
 Display Window **5** (8, 9, 10)
 ENTER **19** (7, 9, 10, 12)
 ISS **10** (14)
 MEGA BASS **8** (16)
 MONO STEREO **10** (11)
 MUSIC MENU **9** (16)
 PHONES jack **21**
 PLAY MODE **20** (8, 9)
 PRESET +/- **18** (10, 11, 12)

RDS (European model only)/DIR **20** (12, 13, 14, 15)
 Remote sensor **25**
 TAPE **3** (13)
 TIMER indicator **2** (15, 18)
 TUNER **6** (10, 11, 14)
 TUNER MEM **19** (10)
 TUNING + **14** (10, 11, 12, 15)
 TUNING - **15** (10, 11, 12, 15)
 VOLUME control **13**

BUTTON DESCRIPTIONS

I/⏻ (power) **1** (7, 11, 15, 18)

CD

⏮⏮⏮ (go back) **15** (8, 9)
⏭⏭⏭ (go forward) **14** (8, 9)
▶▶▶ (play) **11** (8, 9)
⏸ (pause) **23** (8)
⏏ PUSH OPEN/CLOSE **7** (8)
■ (stop) **12** (8, 9)

TAPE

⏭⏭⏭ (fast forward) **14** (13)
⏸ (pause) **23** (13)
▶▶▶ (play) **11** (13, 14, 15)
● (recording) **22** (14, 15)
⏮⏮⏮ (rewind) **15** (13)
⏏ PUSH OPEN/CLOSE **16** (13)
■ (stop) **12** (13, 14)

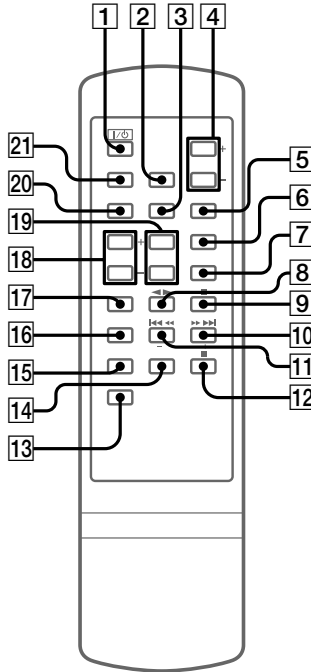

- CD **3** (8, 9, 14)
- CLOCK/TIMER **15** (7, 15, 17)
- DISPLAY **16** (9, 11)
- MEGA BASS **2** (16)
- MUSIC MENU **21** (16)
- PLAY MODE/RDS (European model only)/DIR **17** (8, 9, 12, 13, 14, 15)
- PRESET +/- **18** (10, 11)
- REPEAT **7** (8)
- SLEEP **13** (17)
- TAPE **20** (13)
- TIMER ON/OFF **14** (15, 18)
- TUNER/BAND **5** (10, 11, 14)
- TUNER MEM/ENTER **6** (7, 9, 10, 12, 15, 17, 18)
- TUNING/CLOCK/TIMER +/- **19** (7, 10, 11, 12, 15, 17, 18)
- VOLUME +/- **4**

BUTTON DESCRIPTIONS

- ▶▶** (fast forward) **▶▶▶** (go forward) **10** (8, 9, 13)
- ◀◀** (go back) **◀◀◀** (rewind) **11** (8, 9, 13)
- ⏸** (pause) **12** (8, 13)
- ▶▶◀◀** (play) **8** (8, 9, 13, 14, 15)
- |/⏻** (power) **1** (7, 11, 15, 18)
- (stop) **9** (8, 9, 13, 14)

Hooking up the system

Do the following procedure **1** to **3** to hook up your system using the supplied cords and accessories.

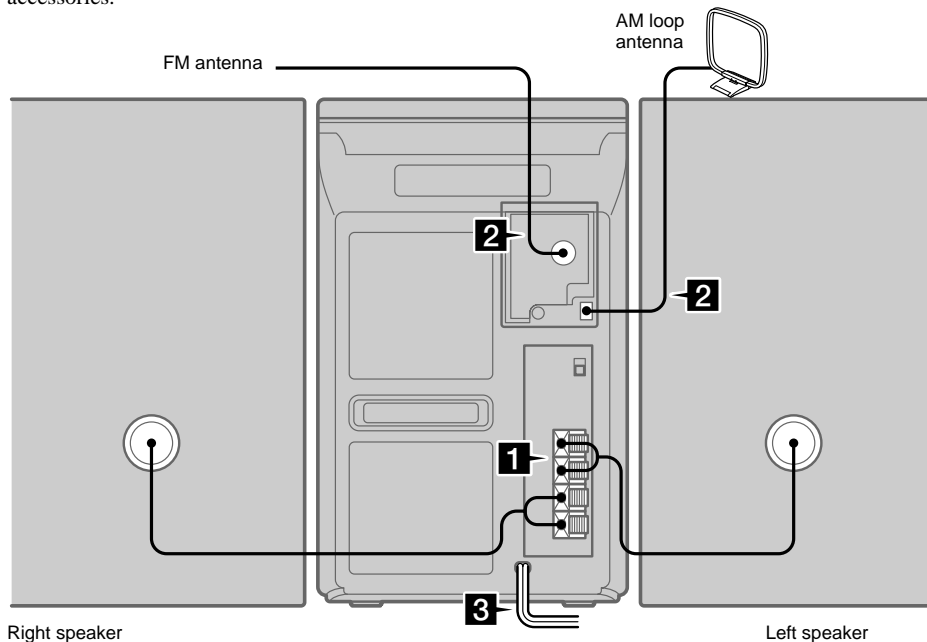

1 Connect the speakers.

Connect the speaker cords to the SPEAKER terminals as shown below.

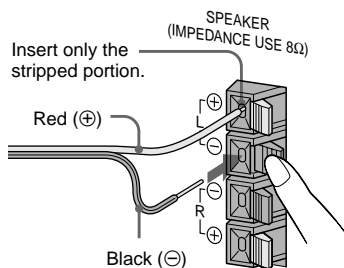

2 Connect the FM/AM antennas.

Set up the AM loop antenna, then connect it.

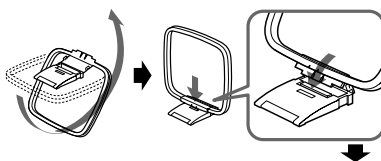

Jack type (A)

Extend the FM lead antenna horizontally. AM loop antenna

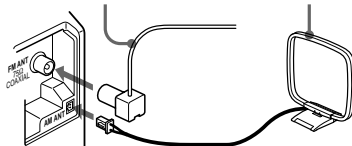

Jack type ②

Extend the FM lead antenna horizontally.

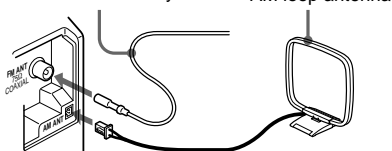
**3 Connect the power cord to a wall outlet.**

If the supplied adaptor on the plug does not fit your wall outlet, detach it from the plug (only for models equipped with the adaptor).

To turn on the system, press **I** / **⏻** (power).

To attach the speaker pads

Attach the supplied speaker pads to the bottom of the speakers to stabilize the speakers and prevent them from slipping.

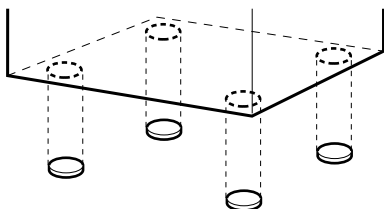

Inserting two size AAA (R03) batteries into the remote

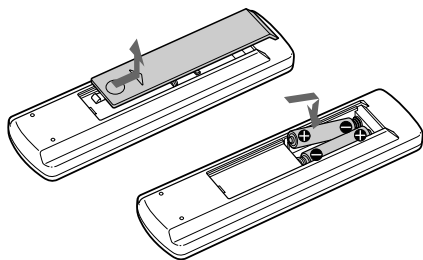
**Tip**

When the remote no longer operates the system, replace both batteries with new ones.

Note

If you do not use the remote for a long period of time, remove the batteries to avoid possible damage from battery leakage.

Setting the time

- 1 Turn on the system.**
- 2 Press CLOCK/TIMER on the remote.**
When you set the clock for the first time, go to step 5.
- 3 Press CLOCK/TIMER on the remote repeatedly until "SET CLK" appears in the display.**
- 4 Press TUNER MEM/ENTER on the remote.**
- 5 Press TUNING/CLOCK/TIMER + or - on the remote repeatedly to set the hour.**
- 6 Press TUNER MEM/ENTER on the remote.**
- 7 Press TUNING/CLOCK/TIMER + or - on the remote repeatedly to set the minute.**
- 8 Press TUNER MEM/ENTER on the remote.**

To reset the system clock

Start over from step 1.

Note

The clock settings are canceled when you disconnect the power cord or if a power failure occurs.

Loading the CD

- 1 Press **▲ PUSH OPEN/CLOSE** down to open the lid of the CD compartment.
- 2 Place a CD with the label side up on the compartment.

When you play a CD single (8 cm CD), place it on the inner circle of the compartment.

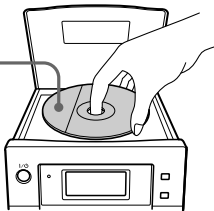

- 3 Press **▲ PUSH OPEN/CLOSE** down to close the lid of the CD compartment.

Playing the CD

— Normal Play/Shuffle Play/Repeat Play

This system lets you play the CD in different play modes.

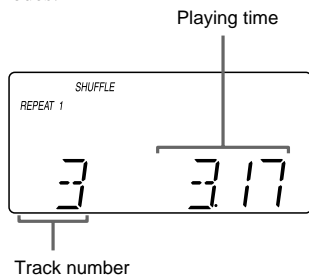

- 1 Press **CD**.
- 2 Press **PLAY MODE (PLAY MODE/RDS/DIR on the remote)** repeatedly until the mode you want appears in the display.

Select	To play
No display	The CD in original order.
SHUFFLE	The tracks on the CD in random order.
PROGRAM	The tracks on the CD in the order you want them to be played. (See "Programing the CD tracks" on page 9.)

- 3 Press **◀▶**.

Other Operations

To	Do this
Stop playback	Press ■ .
Pause	Press ⏸ . Press again to resume play.
Select a track	Press ▶▶▶▶ (to go forward) or ◀◀◀◀ (to go back).
Find a point in a track	During play, press and hold ▶▶▶▶ (to go forward) or ◀◀◀◀ (to go back). Release it when you find the desired point.
Play repeatedly (Repeat Play)	Press REPEAT on the remote during play until "REPEAT" or "REPEAT 1" appears. REPEAT: For all the tracks on the CD up to five times. REPEAT 1: For single track only. To cancel playing repeatedly, press REPEAT on the remote until "REPEAT" or "REPEAT 1" disappears.
Remove the CD	Press ▲ PUSH OPEN/CLOSE .

Programming the CD tracks

— Program Play

You can make a program of up to 32 tracks in the order you want them to be played.

- 1 Press **CD**, then place a CD.
- 2 Press **PLAY MODE (PLAY MODE/RDS/DIR on the remote)** repeatedly until **“PROGRAM”** appears in the display.
- 3 Press **◀◀** or **▶▶** until the desired track appears in the display.

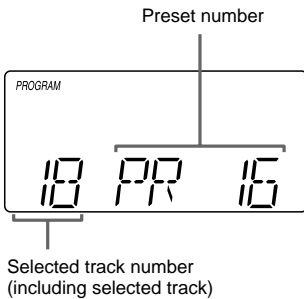

- 4 Press **ENTER (TUNER MEM/ENTER on the remote)**.

The track is programmed. The program step number appears.

- 5 To program additional tracks, repeat steps 3 to 4.

- 6 Press **◀▶**.

Program Play starts.

To	Do this
Cancel Program Play	Press PLAY MODE (PLAY MODE/RDS/DIR on the remote) until “PROGRAM” disappears from the display.
Add a track to the end of the program	Do step 3 and 4 with Program Play stopped.
Erase the entire program	Press ■ once, when Program Play is in stop mode, or twice during Program Play.

Tip

The program you made remains in the system's memory even after it has been played back. Press **CD**, then press **◀▶** to play the same program again.

Using the CD display

Press **DISPLAY** repeatedly.

The display changes as follows:

During normal play

Elapsed playing time on the current track →

Remaining time on the current track →

Remaining time on the current CD → Clock

display (for five seconds) → Elapsed playing

time on the current track → ...

In the stop mode

Total number of tracks and total playing time

→ Clock display (for five seconds) → Total

number of tracks and total playing time → ...

Presetting radio stations

You can preset up to 30 stations.

1 Press TUNER (TUNER/BAND on the remote) repeatedly to select FM or AM.

2 Press and hold TUNING (TUNING/CLOCK/TIMER on the remote) + or – until the frequency indication starts to change, then release it.

Scanning stops automatically when the system tunes in a station. “STEREO” (for a stereo program) appears.

If it doesn't stop automatically, press TUNING (TUNING/CLOCK/TIMER on the remote) + or – repeatedly to tune in a station manually.



3 Press TUNER MEM (TUNER MEM/ENTER on the remote).

A preset number appears in the display. The stations are stored from preset number 1.

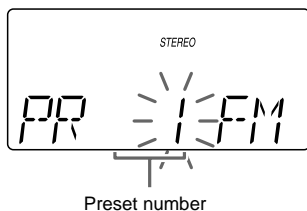

4 Press ENTER (TUNER MEM/ENTER on the remote).

The station is stored.

5 Repeat steps 1 to 4 to store other stations.

To tune in a station with a weak signal

Press TUNING (TUNING/CLOCK/TIMER on the remote) + or – repeatedly in step 2 to tune in the station manually.

To set another station to an existing preset number

Start over from step 1. After step 3, press PRESET + or – repeatedly to select the preset number where you want to store the other station and the press ENTER (TUNER MEM/ENTER on the remote).

You can preset a new station in the selected preset number.

To erase all preset stations

1 Press and hold TUNER MEM (TUNER MEM/ENTER on the remote) until “ERASE” and “PRESET” appear alternately.

2 Press ENTER (TUNER MEM/ENTER on the remote).

All preset stations are cleared.

To change the AM tuning interval (except for the European model)

Disconnect the power cord from the wall outlet first, and then set the AM FREQ STEP switch at the rear to 9 kHz or 10 kHz.

Tip

The preset stations are retained for half a day even if you unplug the power cord or if a power failure occurs.

Listening to the radio

— Preset Tuning

Preset radio stations in the tuner's memory first.

- 1 Press **TUNER (TUNER/BAND on the remote)** repeatedly to select **FM or AM**.
- 2 Press **PRESET + or –** repeatedly to tune in the desired preset station.

The preset number appears in the display for a few seconds.

When only one station is preset, only that station is tuned.

To	Do this
Turn off the radio	Press I/⏻ .

To listen to non-preset radio stations
Use manual or automatic tuning in step 2.
For manual tuning, press **TUNING (TUNING/CLOCK/TIMER on the remote) + or –** repeatedly.

For automatic tuning, press and hold **TUNING (TUNING/CLOCK/TIMER on the remote) + or –**.

Tips

- When an FM program is noisy, set **MONO STEREO** to **MONO** so that "MONO" appears in the display. There will be no stereo effect, but the reception will improve.
- To improve broadcast reception, adjust the antennas.
- You can change the display into the clock display (for five seconds) by pressing **DISPLAY**.

Using the Radio Data System (RDS)

(European model only)

What is the Radio Data System?

Radio Data System (RDS) is a broadcasting service that allows radio stations to send additional information along with the regular program signal. This tuner offers convenient RDS features like station name display and location of stations by program type. RDS is available only on FM stations.*

Note

RDS may not work properly if the station you are tuned in is not transmitting the RDS signal properly or if the signal strength is weak.

* Not all FM stations provide RDS service, nor do they provide the same types of services. If you are not familiar with the RDS system, check with your local radio stations for details on RDS services in your area.

Receiving RDS broadcasts

Simply select a station from the FM band.
When you tune in a station that provides RDS services, "RDS" appears in the display.

To check the RDS information

Each time you press **DISPLAY**, the display changes as follows:

Frequency → RDS name* → RDS TEXT* → RDS type* → Clock display (for five seconds) → Frequency → ...

* If the RDS broadcast is not received, the RDS name, RDS TEXT and RDS type may not appear in the display.

continued

Using the Radio Data System (RDS) (continued)

Locating a station by program type (PTY)

You can locate a station you want by selecting a program type. The system tunes in the type of programs currently being broadcast from the RDS stations stored in the tuner's preset memory.

The types of programs include NEWS, AFFAIRS (current news), INFO, SPORT, EDUCATE (education programs), DRAMA, CULTURE, SCIENCE, VARIED (interviews, games and comedy), POP M, ROCK M, EASY M, LIGHT M, CLASSICS, OTHER M, WEATHER, FINANCE, CHILDREN, SOCIAL, RELIGION, PHONE IN, TRAVEL, LEISURE, JAZZ, COUNTRY, NATION M, OLDIES, FOLK M, DOCUMENT, TEST ALARM and NONE (any programs not defined above).

- 1 Press RDS/DIR (PLAY MODE/RDS/DIR on the remote) while listening to the radio.**
- 2 Press PRESET + or – repeatedly to select the program type you want.**
- 3 Press and hold TUNING (TUNING/CLOCK/TIMER on the remote) + or –.**

When the tuner receives a program, "PTY" flashes.

Tip

"TYPE NOT FOUND" appears when the program type you select is not currently being broadcast.

To cancel PTY

Press RDS/DIR (PLAY MODE/RDS/DIR on the remote) again.

Listening to a traffic information

When the tuner receives traffic information signal, "TRAFFIC INFORMATION" will be scrolled in the display.

- 1 Press RDS/DIR (PLAY MODE/RDS/DIR on the remote) repeatedly until "INFO OFF" or "INFO ON" appears while listening to an FM program.**
- 2 Press ENTER (TUNER MEM/ENTER on the remote) to set "INFO ON".**

Setting the time to the broadcast

You can set the time to the clock information received.

- 1 Press RDS/DIR (PLAY MODE/RDS/DIR on the remote) repeatedly until "SYNC OFF" or "SYNC ON" appears while listening to an FM program.**
- 2 Press ENTER (TUNER MEM/ENTER on the remote) to set "SYNC ON".**

Loading a tape

- 1 Press **TAPE**.
- 2 Press **▲ PUSH OPEN/CLOSE**.
- 3 Insert a tape in deck with the side you want to play/record facing forward.

Insert with the side you want to play/record facing forward.

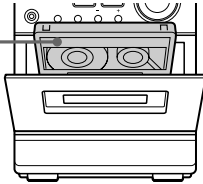

Playing a tape

You can use TYPE I (normal), TYPE II (CrO₂) or TYPE IV (metal) tape.

- 1 Load a recorded tape.
- 2 Press **TAPE**.
- 3 Press **RDS/DIR (PLAY MODE/RDS/DIR on the remote) repeatedly to select** **↔** to play one side, **↔↔** to play both sides, or **↔↔*** to play both sides repeatedly.

* The tape automatically stops after playing back five times.

- 4 Press **◀▶**.

Press **◀▶** again to play the reverse side.

To	Press
Stop play	■
Pause	 Press again to resume play.
Fast-forward or rewind	With the tape stopped, press ◀◀◀/▶▶▶
Remove the cassette	▲ PUSH OPEN/CLOSE

Finding the beginning of a track (AMS*)

During playback, press **◀◀◀ ◀◀** or **▶▶ ▶▶▶**.

The tape is wound or rewound to the beginning of the next or current track, and play will start automatically. The search direction, “+” (forward) or “-” (back), and “1” appear in the display.

* AMS (Automatic Music Sensor)

Tip

You can change the display into the clock display (for five seconds) by pressing **DISPLAY**.

Note

The AMS function may not operate correctly under the following circumstances:

- When the unrecorded space between tracks is less than 4 seconds long.
- If completely different information is recorded on the left and right channels.
- When there are continuous sections of extremely low level or low frequency sound (like those of a baritone sax).
- When the system is placed near a television. (In this case, we recommend moving the system farther away from the television or turning off the television.)

Recording to a tape

— CD Synchro Recording/Recording Manually

You can record from a CD or radio. You can use TYPE I (normal) tape.

Steps	Recording from a CD (CD Synchro Recording)	Recording from the radio
1	Load a blank tape.	
2	Press CD.	Press TUNER (TUNER/BAND on the remote).
3	Load the CD you want to record.	Tune in the station you want to record.
4	Press ●. The deck stands by for recording.	
5	Press ◀▶, if you want to switch the direction.	
6	Press RDS/DIR (PLAY MODE/RDS/DIR on the remote) repeatedly to select ↔ to record on one side, ⇄ to record on both sides.	
7	Press ● again. Recording starts.	

To stop recording

Press ■.

Tips

- For recording from a CD to a tape manually, you can press ◀◀ ◀◀ or ▶▶ ▶▶ to select tracks during recording pause mode (after step 4 and before step 6).
- When you record on both sides, be sure to start from the front side. If you start from the reverse side, recording stops at the end of the reverse side.
- When an AM program is noisy, set ISS to select the position that most decreases the noise.

Timer-recording radio programs

You can record a preset radio station from a specified time.

To timer-record, you must preset the radio station (see “Presetting radio stations” on page 10) and set the clock (see “Setting the time” on page 7) beforehand.

1 Tune in the preset radio station that you want to record from (see “Listening to the radio” on page 11).

2 Press **CLOCK/TIMER** on the remote repeatedly until “**SET TMR**” appears, then press **TUNER MEM/ENTER** on the remote.

“ON” appears, and the hour indication flashes.

3 Set the starting time.

Press **TUNING/CLOCK/TIMER + or –** on the remote repeatedly to set the hour, then press **TUNER MEM/ENTER** on the remote.

The minute indication begins flashing next.

Press **TUNING/CLOCK/TIMER + or –** on the remote repeatedly to set the minute, then press **TUNER MEM/ENTER** on the remote.

The hour indication flashes again.

4 Set the time to stop the recording following the procedure in step 3.

5 Press **TUNING/CLOCK/TIMER + or –** on the remote repeatedly until “**RECORD**” appears, then press **TUNER MEM/ENTER** on the remote.

The **TIMER** indicator lights up.

6 Press **TUNING/CLOCK/TIMER + or –** on the remote repeatedly to adjust the volume* for listening to the radio when it is activated by the timer, then press **TUNER MEM/ENTER** on the remote.

* This does not affect the recording volume; it only adjusts the volume for when the radio turns on at the preset time.

7 Insert a recordable tape with the side you want to record on facing towards you.

8 Press **●**.

9 Press **◀▶**, if you want to switch the direction.

10 Press **RDS/DIR (PLAY MODE/RDS/DIR on the remote)** repeatedly to select **↔** to record on one side, **↔** to record on both sides.

11 Press **I/⏻** to turn off the system.

To	Do this
Check or change the setting	Turn on the system and then start over from step 1 when the TIMER indicator appears.
Activate the timer operation	Press TIMER ON/OFF on the remote until the TIMER indicator goes on.
Cancel the timer operation	Press TIMER ON/OFF on the remote until the TIMER indicator goes off.

Notes

- If the system is in the recording or recording-pause mode at the preset time, the timer recording will not be made.
- If the system is playing back a tape at the preset time, the system will switch to the tuner, but the timer recording will not be made.

Adjusting the sound

Press MEGA BASS.

“MEGA BASS” appears in the display. To return to normal sound, press the button again.

Selecting the audio emphasis

Selecting the preset effect from the music menu

Press MUSIC MENU repeatedly to select the preset effect you desire.

Each time you press the button, the display changes as follows:

ROCK → POP → JAZZ → FLAT* →

ROCK → ...

* “FLAT” is displayed for a few seconds.

Falling asleep to music

— Sleep Timer

You can set the system to turn off after certain amount of time, so that you can fall asleep to music.

Press SLEEP on the remote.

Every time you press the button, the minute display (the turn-off time) changes as follows:
90 → 80 → 70 → ... → 10 → OFF → 90 → ...

While the Sleep Timer is on, "TIMER" flashes in the display.

To	Press
Check the remaining time	SLEEP on the remote once.
Change the time to turn off	SLEEP on the remote repeatedly to select the time you want.
Cancel the Sleep Timer function	SLEEP on the remote repeatedly until "SLEEP OFF" appears.

Waking up to music

— Daily Timer

You can wake up to music at a preset time every day. Make sure you have set the clock (see page 7).

1 Prepare the sound source you want to play.

- CD: Load a CD.
- Tape: Insert a tape with the side you want to play on facing towards you.
- Radio: Tune in the preset station you want (see page 10).

2 Press CLOCK/TIMER on the remote repeatedly until "SET TMR" appears, then press TUNER MEM/ENTER on the remote.

"ON" appears, and the hour indication flashes.

3 Set the starting time.

Press TUNING/CLOCK/TIMER + or – on the remote repeatedly to set the hour, then press TUNER MEM/ENTER on the remote.

The minute indication begins flashing next.

Press TUNING/CLOCK/TIMER + or – on the remote repeatedly to set the minute, then press TUNER MEM/ENTER on the remote.

The hour indication flashes again.

4 Set the time to stop the playback following the procedure in step 3.

5 Press TUNING/CLOCK/TIMER + or – on the remote repeatedly until the music source you want appears, and then press TUNER MEM/ENTER on the remote.

The display changes as follows:

TUNER → RECORD (tuner) → CD → TAPE → TUNER → ...

The TIMER indicator lights up.

continued

Waking up to music (continued)

6 Press TUNER MEM/ENTER on the remote.

The type of timer followed by the start time, stop time, and the music source, appear, then the original display appears.

7 Press TUNING/CLOCK/TIMER + or – on the remote to adjust the volume, then press TUNER MEM/ENTER on the remote.

8 Press I/⏻ to turn off the system.

To	Do this
Check or change the setting	Turn on the system and then start over from step 1 when the TIMER indicator appears.
Activate the timer operation	Press TIMER ON/OFF on the remote until the TIMER indicator goes on.
Cancel the timer	Press TIMER ON/OFF on the remote until the TIMER indicator goes off.

Precautions

On operating voltage

Before operating the system, check that the operating voltage of your system is identical with the voltage of your local power supply.

On safety

- The system is not disconnected from the AC power source (mains) as long as it is connected to the wall outlet, even if the system itself has been turned off.
- Unplug the system from the wall outlet (mains) if it is not to be used for an extended period of time. To disconnect the cord (mains lead), pull it out by the plug. Never pull the cord itself.
- Should any solid object or liquid fall into the component, unplug the stereo system and have the component checked by qualified personnel before operating it any further.
- The AC power cord must be changed only at a qualified service shop.

On placement

- Place the system in a location with adequate ventilation to prevent heat build-up the system.
- Do not place the system in an inclined position.
- Do not place the system in locations where it is;
 - Extremely hot or cold
 - Dusty or dirty
 - Very humid
 - Vibrating
 - Subject to direct sunlight.

On heat buildup

- Although the system heats up during operation, this is not malfunction.
- Place the system in a location with adequate ventilation to prevent heat build-up in the system.

If you continuously use this system at a large volume, the cabinet temperature of the top, side and bottom rises considerably. To avoid burning yourself, do not touch the cabinet.

To prevent a malfunction, do not cover the ventilation hole for the cooling fan.

On operation

- If the system is brought directly from a cold to a warm location, or is placed in a very damp room, moisture may condense on the lens inside the CD player. Should this occur, the system will not operate properly. Remove the CD and leave the system turned on for about an hour until the moisture evaporates.
- When you move the system, take out any discs.

If you have any questions or problems concerning your stereo system, please consult your nearest Sony dealer.

Notes on CDs

- Before playing, clean the CD with a cleaning cloth. Wipe the CD from the center out.
- Do not use solvents.
- Do not expose the CD to direct sunlight or heat sources.
- Discs with non-standard shapes (e.g., heart, square, star) cannot be played on this system. Attempting to do so may damage the system. Do not use such discs.

Note on CD-R/CD-RW playback

Discs recorded on CD-R/CD-RW drives may not be played back because of scratches, dirt, recording condition or the drive's characteristics. Besides, the discs, which are not yet finalized at the end of recording cannot be played back.

Cleaning the cabinet

Use a soft cloth slightly moistened with mild detergent solution.

To save a tape permanently

To prevent a tape from being accidentally recorded over, break off the cassette tab from side A or B as illustrated.

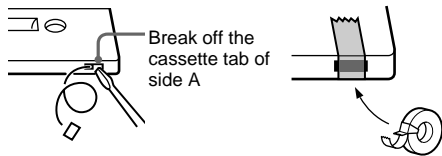

If you later want to reuse the tape for recording, cover the broken tab with adhesive tape.

continued

Precautions (continued)

Before placing a cassette in the tape deck

Take up any slack in the tape. Otherwise the tape may get entangled in the parts of the tape deck and become damaged.

When using a tape longer than 90 minutes

The tape is very elastic. Do not change the tape operations such as play, stop, and fast-winding (etc.) frequently. The tape may get entangled in the tape deck.

Cleaning the tape heads

Clean the tape heads after every 10 hours of use. Make sure to clean the tape heads before you start an important recording or after playing an old tape. Use separately sold dry-type or wet-type cleaning cassette. For details, refer to the instructions of the cleaning cassette.

Demagnetizing the tape heads

Demagnetize the tape heads and the metal parts that have contact with the tape every 20 to 30 hours of use with a separately sold demagnetizing cassette. For details, refer to the instructions of the demagnetizing cassette.

Troubleshooting

If you have any problem using this system, use the following check list.

First, check that the power cord is connected firmly and the speakers are connected correctly and firmly.

Should any problem persist, consult your nearest Sony dealer.

General

The clock setting/radio presetting/timer is canceled.

- The power cord is disconnected or a power failure occurs longer than half a day.

Redo the following:

- “Setting the time” on page 7
- “Presetting radio stations” on page 10

If you have set the timer, also redo “Timer-recording radio programs” on page 15 and “Waking up to music” on page 17.

There is no sound.

- Turn VOLUME clockwise and hold.
 - The headphones are connected.
 - Insert only the stripped portion of the speaker cord into the SPEAKER terminal. Inserting the vinyl portion of the speaker cord will obstruct the speaker connections.
-

There is severe hum or noise.

- A TV or VCR is placed too close to the stereo system. Move the stereo system away from the TV or VCR.
-

The clock indication does not show the correct time.

- A power interruption occurred. Set the clock and timer settings again.
-

The timer does not function.

- Set the clock correctly.
- You cannot activate the Timer-recording and Daily Timer at the same time.
- When you used the Sleep Timer, Daily Timer and Timer-recording will not turn on the system until the Sleep Timer turns it off.

The remote does not function.

- There is an obstacle between the remote and the system.
- The remote is not pointing in the direction of the system's sensor.
- The batteries have run down. Replace the batteries.

The color irregularity on a TV screen persists.

- Turn off the TV set once, then turn it on after 15 to 30 minutes. If the color irregularity still persists, place the speakers farther away from the TV set.

Speakers

Sound comes from one channel or unbalanced left and right volume.

- Check the speaker connection and speaker placement.

Sound lacks bass.

- Check that the speaker's + and - terminals are connected correctly.

CD Player

The CD compartment does not close.

- The CD is not placed properly.

The CD will not play.

- The CD is not lying flat in the CD compartment.
- The CD is dirty.
- The CD is inserted label side down.
- Moisture condensation has built up. Remove the CD and leave the system turned on for about an hour until the moisture evaporates.

Tape Deck

The tape does not record.

- No tape in the cassette compartment.
- The tab has been removed from the cassette.
- The tape has reeled to the end.

The tape does not record nor play or there is a decrease in sound level.

- The heads are dirty. Clean them (see "Cleaning the tape heads" on page 20).
- The record/playback heads are magnetized. Demagnetize them (see "Demagnetizing the tape heads" on page 20).

The tape does not erase completely.

- The record/playback heads are magnetized. Demagnetize them (see "Demagnetizing the tape heads" on page 20).

There is excessive wow or flutter, or the sound drops out.

- The capstans or pinch rollers are dirty. Clean them (see "Cleaning the tape heads" on page 20).

Noise increases or the high frequencies are erased.

- The record/playback heads are magnetized. Demagnetize them (see "Demagnetizing the tape heads" on page 20).

Tuner

Noise is heard.

- Adjust the antennas.

A stereo FM program cannot be received in stereo.

- Set MONO STEREO so that "STEREO" appears.

Messages

The following message may appear in the display during operations.

NO DISC

- There is no disc on the CD compartment.

Specifications

AUDIO POWER SPECIFICATIONS:

(U.S.A. model only)

POWER OUTPUT AND TOTAL

HARMONIC DISTORTION:

with 8 Ω loads both channels driven, from 120 - 10,000 Hz; rates 12 W per channel minimum RMS power, with no more than 10% total harmonic distortion from 250 mW to rated output.

Amplifier section Canadian model:

Continuous RMS power output (reference)
12 + 12 W
(8 Ω at 1 kHz, 10% THD)

European model:

DIN power output (rated) 11 + 11 W
(8 Ω at 1 kHz, DIN)
Continuous RMS power output (reference)
12 + 12 W
(8 Ω at 1 kHz, 10% THD)
Music power output (reference)
27 + 27 W

Other model:

The following measured at AC 230 V, 50/60 Hz
DIN power output (rated) 11 + 11 W
(8 Ω at 1 kHz, DIN)
Continuous RMS power output (reference)
12 + 12 W
(8 Ω at 1 kHz, 10% THD)
Outputs
PHONES: Accepts headphones of
(stereo mini jack) 8 Ω or more
SPEAKER: Accepts impedance of 8 to
16 Ω

CD player section

System Compact disc and digital audio system
Laser Semiconductor laser ($\lambda=780$ nm)
Emission duration: continuous
Frequency response 20 Hz - 20 kHz (± 0.5 dB)

Tape player section

Recording system 4-track 2-channel stereo
Frequency response 50 - 13 000 Hz (± 3 dB), using Sony TYPE I cassette
Wow and flutter $\pm 0.15\%$ W.Peak (IEC)
0.1% W.RMS (NAB)
 $\pm 0.2\%$ W.Peak (DIN)

Tuner section

FM stereo, FM/AM superheterodyne tuner

FM tuner section

Tuning range 87.5 - 108.0 MHz
Antenna FM lead antenna
Antenna terminal 75 Ω coaxial
Intermediate frequency 10.7 MHz

AM tuner section

Tuning range
Pan-American model: 530 - 1 710 kHz
(with the interval set at 10 kHz)
531 - 1 710 kHz
(with the interval set at 9 kHz)
European model: 531 - 1 602 kHz
(with the interval set at 9 kHz)
Other models: 531 - 1 602 kHz
(with the interval set at 9 kHz)
530 - 1 710 kHz
(with the interval set at 10 kHz)
Antenna AM loop antenna
Antenna terminal External antenna terminal
Intermediate frequency 450 kHz

Speaker

Speaker system	Bass-reflex type
Speaker units	Full range 10 cm, cone type
Nominal impedance	8 Ω
Dimensions (w/h/d)	Approx. 145 \times 238 \times 171 mm
Mass	Approx. 1.4 kg net per speaker

General

Power requirements

North American model:	120 V AC, 60 Hz
European model:	230 V AC, 50/60 Hz
Mexican model:	120 V AC, 60 Hz
Argentine model:	220 V AC, 50/60 Hz
Hong Kong model:	230 V AC, 50/60 Hz
Other models:	230 V AC, 50/60 Hz

Power consumption

U.S.A. model:	35 W
Canadian model:	35 W
European model:	40 W
	0.9 W (in the standby mode)
Other models:	40 W

Dimensions (w/h/d): Approx. 145 \times 238 \times 234 mm

Mass: Approx. 3.4 kg

Supplied accessories: AM loop antenna (1)
Remote Commander (1)
Batteries (2)
FM lead antenna (1)
Speaker pads (8)

Design and specifications are subject to change without notice.

