INSTRUCTION MANUAL

EN

GUIDE FOR USING THE DISHWASHER AND THE WASHING PROGRAMS

1. Safety and operating instructions	2
2. Installation and hook-up	5
3. Description of the controls	9
4. Operating instructions	18
5. Cleaning and maintenance	28
6. Troubleshooting	32

Thank you for choosing one of our products. You are advised to read this manual carefully; it contains all the information you need about the right conditions for the proper, safe use of your dishwasher.

The individual sections are laid out to provide you with a step-by-step guide to all your appliance's functions; the texts are easy to understand and are complete with detailed illustrations.

Recommendations are given for the correct use of the baskets, spray arms, containers, filters, washing programs, and for operating the controls.

Following the cleaning instructions provided here will keep your dishwasher's performance at peak levels in the long term.

This user-friendly manual will provide answers to all your questions about use of the dishwasher.



INSTALLATION INSTRUCTIONS: these are intended for the **qualified technician** who must carry out the installation, hook-up and testing of the appliance.



USER INSTRUCTIONS: these consist of recommendations for using the appliance, a description of its controls and of the correct cleaning and maintenance procedures.

1. Safety and operating instructions



THIS MANUAL FORMS AN INTEGRAL PART OF THE APPLIANCE: IT MUST ALWAYS BE KEPT INTACT TOGETHER WITH THE DISHWASHER. BEFORE USING THE APPLIANCE, CAREFULLY READ ALL THE INSTRUCTIONS CONTAINED IN THIS MANUAL.

INSTALLATION MUST BE PERFORMED BY A QUALIFIED TECHNICIAN, IN COMPLIANCE WITH THE REGULATIONS IN FORCE. THIS APPLIANCE IS INTENDED FOR DOMESTIC USE, AND COMPLIES WITH THE **EEC DIRECTIVES 73/23, 89/336 (INCLUDING 92/31 AND 93/68)** CURRENTLY IN FORCE, INCLUDING THE PREVENTION AND ELIMINATION OF RADIO FREQUENCY INTERFERENCE.

THE APPLIANCE IS DESIGNED FOR THE FOLLOWING PURPOSE: **WASHING AND DRYING OF DISHES**; ANY OTHER USE SHALL BE CONSIDERED IMPROPER. **THE MANUFACTURER DECLINES ALL RESPONSIBILITY FOR USES OTHER THAN THOSE DESCRIBED ABOVE.**



THE NAME PLATE FEATURING THE TECHNICAL DATA, SERIAL NUMBER AND MARKINGS IS VISIBLY POSITIONED ON THE INNER EDGE OF THE DOOR. **THE NAME PLATE ON THE INNER EDGE OF THE DOOR MUST NEVER BE REMOVED.**



DO NOT LEAVE THE DISCARDED PACKAGING MATERIALS UNSUPERVISED WITHIN THE HOME. SEPARATE THE VARIOUS MATERIALS WHICH MAKE UP THE PACKAGING AND TAKE THEM TO THE NEAREST SORTED WASTE COLLECTION CENTRE.



THE APPLIANCE MUST BE PROVIDED WITH AN EARTH CONNECTION IN ACCORDANCE WITH THE ELECTRICAL SAFETY REGULATIONS IN FORCE.

THE MANUFACTURER DECLINES ALL RESPONSIBILITY FOR DAMAGE TO PERSONS OR PROPERTY RESULTING FROM THE FAILURE TO EARTH THE APPLIANCE OR FROM A DEFECTIVE EARTH CONNECTION.



IF THE APPLIANCE IS INSTALLED ON A CARPETED OR COVERED FLOOR, ENSURE THAT THE OPENINGS ON ITS UNDERSIDE ARE NOT OBSTRUCTED.

ALWAYS SWITCH OFF THE DISHWASHER AFTER EACH USE TO AVOID WASTING ELECTRICITY.



OBSOLETE APPLIANCES MUST BE RENDERED UNUSABLE. CUT OFF THE MAINS POWER CORD AFTER UNPLUGGING IT FROM THE WALL OUTLET, AND MAKE SAFE ANY COMPONENTS WHICH MIGHT BE DANGEROUS FOR CHILDREN (LOCKS, DOORS, ETC.).



THIS APPLIANCE IS MARKED ACCORDING TO THE **EUROPEAN DIRECTIVE 2002/96/EC** ON WASTE ELECTRICAL AND ELECTRONIC EQUIPMENT (**WEEE**).

BY ENSURING THIS PRODUCT IS DISPOSED OF CORRECTLY, YOU WILL HELP PREVENT POTENTIAL NEGATIVE CONSEQUENCES FOR THE ENVIRONMENT AND HUMAN HEALTH, WHICH COULD OTHERWISE BE CAUSED BY INAPPROPRIATE WASTE HANDLING OF THIS PRODUCT.



THE SYMBOL  ON THE PRODUCT, OR ON THE DOCUMENTS ACCOMPANYING THE PRODUCT, INDICATES THAT THIS APPLIANCE MAY NOT BE TREATED AS HOUSEHOLD WASTE. INSTEAD IT SHALL BE HANDED OVER TO THE APPLICABLE COLLECTION POINT FOR THE RECYCLING OF ELECTRICAL AND ELECTRONIC EQUIPMENT.

DISPOSAL MUST BE CARRIED OUT IN ACCORDANCE WITH LOCAL ENVIRONMENTAL REGULATIONS FOR WASTE DISPOSAL. FOR MORE DETAILED INFORMATION ABOUT TREATMENT, RECOVERY AND RECYCLING OF THIS PRODUCT, PLEASE CONTACT YOUR LOCAL CITY OFFICE, YOUR HOUSEHOLD WASTE DISPOSAL SERVICE OR THE SHOP WHERE YOU PURCHASED THE PRODUCT.

IN THE EVENT OF A FAULT, DISCONNECT THE DISHWASHER FROM THE ELECTRICAL POWER SUPPLY AND SHUT OFF THE WATER TAP.



DO NOT USE APPLIANCES WHICH HAVE BEEN DAMAGED DURING TRANSIT! IF IN DOUBT, CONSULT YOUR DEALER.

THE APPLIANCE MUST BE INSTALLED AND CONNECTED IN ACCORDANCE WITH THE INSTRUCTIONS PROVIDED BY THE MANUFACTURER OR BY A QUALIFIED TECHNICIAN.



THIS DISHWASHER MUST BE USED BY ADULTS.

USE BY PERSONS WITH REDUCED MENTAL AND/OR PHYSICAL CAPABILITIES IS ONLY PERMITTED UNDER THE SUPERVISION OF A PERSON RESPONSIBLE FOR THEIR SAFETY.

KEEP CHILDREN AWAY FROM DETERGENTS AND PACKAGING MATERIALS (PLASTIC BAGS, POLYSTYRENE, ETC.), AND NEVER ALLOW THEM TO APPROACH OR PLAY WITH THE DISHWASHER, SINCE IT MIGHT CONTAIN DETERGENT RESIDUES CAPABLE OF CAUSING PERMANENT DAMAGE TO THE EYES, MOUTH AND THROAT, AND EVEN LEADING TO SUFFOCATION.



DO NOT INTRODUCE SOLVENTS SUCH AS ALCOHOL OR TURPENTINE WHICH MAY CAUSE AN EXPLOSION.

DO NOT LOAD DISHES THAT ARE SOILED WITH ASH, WAX OR PAINTS.

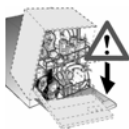

LEANING OR SITTING ON THE DISHWASHER DOOR WHEN OPEN MAY CAUSE THE APPLIANCE TO OVERTURN, PUTING PEOPLE AT RISK. NEVER LEAVE THE DISHWASHER DOOR OPEN; PEOPLE MIGHT TRIP OVER IT.



DO NOT DRINK THE WATER RESIDUES WHICH MAY BE PRESENT INSIDE THE DISHES OR DISHWASHER AT THE END OF THE WASHING PROGRAM AND BEFORE THE DRYING CYCLE.



KNIVES OR OTHER SHARP-ENDED COOKING UTENSILS MUST BE PLACED IN THE CUTLERY BASKET BLADE-DOWN, OR LAID HORIZONTAL IN THE TOP BASKET. TAKE CARE NOT TO CUT YOURSELF AND ENSURE THAT THEY DO NOT PROJECT FROM THE BASKET.



AQUASTOP MODELS

THE AQUASTOP DEVICE PREVENTS FLOODING IN THE EVENT OF A WATER LEAK. WHEN THE AQUASTOP DEVICE IS TRIPPED, CALL IN A QUALIFIED TECHNICIAN TO IDENTIFY AND REPAIR THE FAULT.

IN MODELS EQUIPPED WITH THE AQUASTOP DEVICE, THERE IS A SOLENOID VALVE INSIDE THE WATER INTAKE HOSE. DO NOT CUT THE HOSE AND DO NOT ALLOW THE SOLENOID VALVE TO DROP INTO WATER. IN THE EVENT OF DAMAGE TO THE WATER INTAKE HOSE, DISCONNECT THE APPLIANCE FROM THE ELECTRICAL POWER SUPPLY AND FROM THE WATER SUPPLY.



IMMEDIATELY AFTER INSTALLING THE DISHWASHER, PERFORM A QUICK TEST OF THE APPLIANCE FOLLOWING THE INSTRUCTIONS BELOW. IF THE DISHWASHER FAILS TO OPERATE CORRECTLY, DISCONNECT IT FROM THE ELECTRICAL POWER SUPPLY AND CALL THE NEAREST TECHNICAL SERVICE CENTRE. DO NOT ATTEMPT TO REPAIR THE APPLIANCE.



THE DISHWASHER MEETS ALL THE REQUIREMENTS SET OUT BY THE REGULATIONS IN FORCE CONCERNING SAFETY AND ELECTRICAL EQUIPMENT. ANY TECHNICAL CHECKS SHOULD BE CONDUCTED EXCLUSIVELY BY A TRAINED AND AUTHORISED TECHNICIAN: REPAIRS CARRIED OUT BY UNAUTHORISED PERSONS WILL INVALIDATE THE WARRANTY, AS WELL AS POSING A POTENTIAL HAZARD TO THE USER.

The manufacturer declines all responsibility for damage to persons or property resulting from failure to observe the above precautions, from tampering with even a single component of the appliance, or from the use of non original spare parts.



2. Installation and hook-up

Remove the polystyrene basket retainers.

Position the appliance in the desired place of installation. The back or sides of the dishwasher may be placed up against walls or other furniture units. If the dishwasher is installed near a heat source, fit the special insulating panel to prevent overheating and malfunction of the appliance. To ensure stability, install integrated or built-under dishwashers only under continuous worktops, and screw them to the adjacent units. To facilitate the installation procedure, the intake and drain hoses can be positioned in any direction; make sure that the hoses are not kinked, crushed or pulled too tightly. Make sure to tighten the locking ring-nut once the pipes have been placed in the direction required. A hole at least 8 cm in diameter is required to allow the power supply cable and pipes to pass.

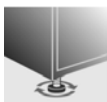

Level the appliance on the floor using its adjustable feet. This operation is essential for ensuring correct operation of the dishwasher.



*Building-in a dishwasher underneath a ceramic hob is **absolutely forbidden**.*

*A dishwasher can be built-in underneath a conventional hob provided there is **no break** in the kitchen worktop, and the dishwasher and hob are **installed and secured correctly**, so that **no hazards are generated**.*

When installing the dishwasher in a compartment next to one or more other appliances, it is essential to comply with all the recommendations provided by the appliance's manufacturer (minimum distances, installation procedures, etc.).

For free-standing models only:

- *Installing a hob on top of a free-standing dishwasher is **absolutely forbidden**.*
- *If the appliance is not built-in and is therefore accessible on one side, the door hinge area must be covered for safety reasons (injury hazard). The covering fixtures are available as an accessory from specialist dealers or the After-Sales Service.*
- *To build in the dishwasher, the **special kit** must be purchased from authorised dealers or the After-Sales Service.*



Some models are equipped with only one adjustable foot at the rear, which can be adjusted by turning the screw on the lower front part of the appliance.



2.1 Water supply connection



Preventing the risk of clogging or damage: if the water pipe is new or has not been used for a long time, before connecting to the water supply check that the water is clear and free of impurities, to prevent damage to the appliance.

The dishwasher must always be connected to the water system with new hoses; old or used hoses must never be reused.

CONNECTING TO THE WATER SUPPLY

Connect the intake hose to a cold water supply with $\frac{3}{4}$ " gas thread, inserting the filter **A** supplied with the dishwasher. **Take care to screw the hose firmly into place with your hands and then complete by tightening about $\frac{1}{4}$ of a turn with pliers.**

In dishwashers equipped with the ACQUASTOP device, the filters is already fitted inside the threaded ring.

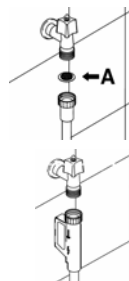

The dishwasher can also be connected to a hot water supply **not exceeding 60°C**. Supplying the appliance with hot water cuts down the washing time by approximately 20 minutes, but slightly reduces its effectiveness. Make the connection to the domestic hot water supply using the same procedure described for connecting to the cold water supply.



DRAIN CONNECTION

Insert the dishwasher's drain hose into a drain pipe having a diameter of at least **4 cm**, or alternatively, place it inside the kitchen sink using the plastic support provided, taking care not to crush or excessively bend the hose. It is important to prevent the hose from coming loose and falling. For this purpose, the plastic support is equipped with a hole for tying it to the wall or water tap.

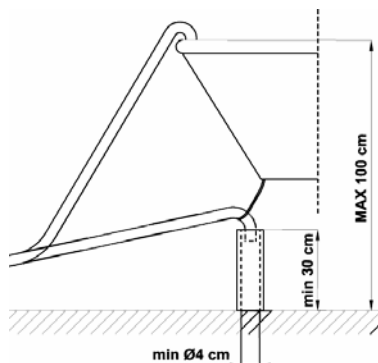

The free end should be positioned at a height of between **30 and 100 cm**, and should never be submerged in water. If a horizontal drain extension hose is used (for a maximum of 3 m) the drain hose can be placed at a maximum height of **85 cm** from the ground.



2.2 Electrical connection and precautions

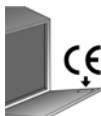

CHECK THAT THE VOLTAGE AND THE FREQUENCY OF THE MAINS MATCH THE RATINGS ON THE NAME PLATE OF THE APPLIANCE POSITIONED ON THE INNER EDGE OF THE DOOR.



THE PLUG ON THE SUPPLY CORD AND THE CORRESPONDING SOCKET OUTLET MUST BE OF THE SAME TYPE AND MEET THE REGULATIONS IN FORCE.

THE PLUG MUST BE ACCESSIBLE AFTER INSTALLATION.

NEVER DISCONNECT THE PLUG BY PULLING ON THE POWER SUPPLY LEAD.

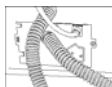

IN THE EVENT OF DAMAGE TO THE SUPPLY CORD, HAVE IT REPLACED BY THE MANUFACTURER OR AN AUTHORIZED TECHNICAL SERVICE CENTRE. AFTER CHANGING THE SUPPLY CORD, MAKE SURE THAT THE **BRACKET** WHICH SECURES THE CORD IS FIXED SECURELY IN PLACE.



DO NOT USE ADAPTORS OR SHUNT CONNECTIONS IN ORDER TO AVOID THE POSSIBILITY OF OVERHEATING OR BURNING.

IF THE APPLIANCE IS PROVIDED WITH A PLUGLESS SUPPLY CORD:



IT IS NECESSARY TO INSTALL IN THE FIXED WIRING AN ALL-POLE DISCONNECTION DEVICE HAVING A GAP BETWEEN CONTACTS OF AT LEAST **3.5MM**. AFTER INSTALLATION THE DISCONNECTION DEVICE HAS TO BE EASY TO REACH.



THE CONNECTION TO THE MAINS MUST BE CARRIED OUT BY A **QUALIFIED TECHNICIAN** IN ACCORDANCE TO THE SCHEME SHOWN BELOW AND THE REGULATIONS IN FORCE.

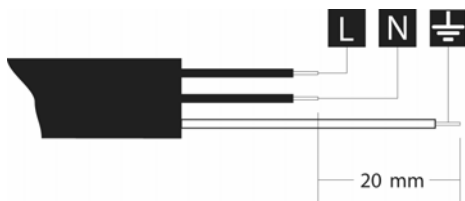

L = brown
N = blue
⊕ = yellow-green



In the event of damage to the supply cord, have it replaced by the manufacturer or an Authorized Technical Service Centre in order to avoid any risk.

**FOR GREAT BRITAIN ONLY:**

THIS APPLIANCE MUST BE EARTHED.

Fuse replacement

If the mains lead of this appliance is fitted with a **BS 1363A 13amp** fused plug, to change a fuse in this type of plug use an **A.S.T.A.** approved fuse to **BS 1362** type and proceed as follows:

1. Remove the fuse cover **A** and fuse **B**.
2. Fit replacement 13A fuse into fuse cover.
3. Refit both into plug.

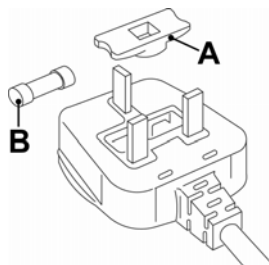

The fuse cover must be refitted when changing a fuse and if the fuse cover is lost the plug must not be used until a correct replacement is fitted.

Correct replacement are identified by the colour insert or the colour embossed in words on the base of the plug.

Replacement fuse covers are available from your local electrical store.



3. Description of the controls

3.1 Front panel

All the dishwasher control are grouped on the front panel.

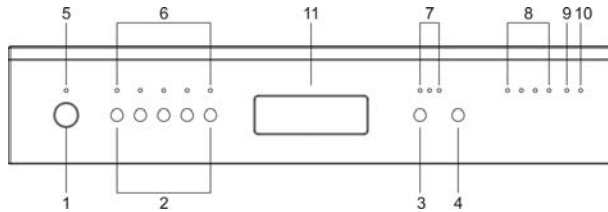

1	ON/OFF BUTTON
2	SELECTION PROGRAMS BUTTONS (P1...P5)
3	DELAY PROGRAM BUTTON (on some models only)
4	START/PAUSE BUTTON
5	POWER ON LIGHT
6	PROGRAMS LIGHTS
7	DELAY PROGRAM LIGHTS (on some models only)
8	PHASES/PROGRAM LIGHTS
9	NO SALT LIGHT (on some models only)
10	NO RINSE AID LIGHT (on some models only)
11	RECESSED DOOR HANDLE



PROGRAM	SELECTION	TYPE AND GRADE DIRT	PROGRESS PROGRAM	DURATION	CONSUMPTION	
				MINUTES (2)	WATER LITRES (1)	POWER KWh (2)
SOAK		PANS AND DISHES AWAITING COMPLETION OF THE LOAD	Cold prewash	9'	5	0,02
DELICATE		DELICATE DISHES WITH NORMAL DIRT	Wash at 38°C Cold rinse Rinse at 58°C	45	13	0,70
ECO (*) EN 50242		DISHES WITH NORMAL DIRT, WASHED IMMEDIATELY AFTER USE	Wash at 55°C Cold rinse Rinse at 66°C Dry	175'	**	**
FAST & STRONG		MIXED DISHES WITH NORMAL DIRT, WITHOUT DRIED-ON RESIDUES	Wash at 65°C Cold rinse Rinse at 70°C	50'	10	1,20
ULTRA CLEAN		VERY DIRTY PANS AND DISHES, WASHED IMMEDIATELY AFTER USE	Wash at 70°C 2 cold rinses Rinse at 70°C Dry	95'	17	1,45

Only run the soak program with half loads.

The "**ULTRA CLEAN**" and "**ULTRA CLEAN+**" program terminates with an anti-bacteria rinse that ensures a further reduction in the bacteria level.

If the temperature falls during this rinse stage (e.g. because the door is opened or due to a power blackout), the light (6) of the current program flashes to warn that the anti-bacteria effect is not guaranteed.

(*) Reference program as per **EN 50242**.

(**) See energy label.

(1) Average power consumption with the softener set on **level 2**.

(2) The cycle duration and power consumption may vary according to the water and room temperatures, and the type and amount of dishes.



The washing cycle will not take place if the dishwasher door is left open or not properly closed.



User instructions

EN

PROGRAM	SELECTION	TYPE AND GRADE DIRT	PROGRESS PROGRAM	DURATION	CONSUMPTION	
				MINUTES (2)	WATER LITRES (1)	POWER KWh (2)
DELICATE	+	DELICATE DISHES WITH NORMAL DIRT	Cold prewash Wash at 45°C Cold rinse Rinse at 70°C Dry	59'	12	0,90
BIO	+	DISHES WITH NORMAL DIRT, EVEN WITH DRIED-ON RESIDUES	Cold prewash Wash at 55°C Cold rinse Rinse at 70°C Dry	85'	16	1,10
NORMAL	+	DISHES WITH NORMAL DIRT, EVEN WITH DRIED-ON RESIDUES	Cold prewash Wash at 65°C Cold rinse Rinse at 70°C Dry	90'	17	1,30
ULTRA CLEAN+	+	VERY DIRTY PANS AND DISHES, EVEN WITH DRIED-ON RESIDUES	Prewash at 45°C Wash at 70°C 2 cold rinses Rinse at 70°C Dry	110'	20	1,60

The "ULTRA CLEAN" and "ULTRA CLEAN+" program terminates with an anti-bacteria rinse that ensures a further reduction in the bacteria level.

If the temperature falls during this rinse stage (e.g. because the door is opened or due to a power blackout), the light (6) of the current program flashes to warn that the anti-bacteria effect is not guaranteed.

- (1) Average power consumption with the softener set on **level 2**.
- (2) The cycle duration and power consumption may vary according to the water and room temperatures, and the type and amount of dishes.



The washing cycle will not take place if the dishwasher door is left open or not properly closed.



3.2 Washing programs

The dishwasher is equipped with a control panel, described in chapter "3. Description of the controls", from which it is possible to carry out all the power switch-on, switch-off and programming operations.



Before starting a washing program make sure that:

- The water supply tap is **open**.
- The **correct amount of detergent** has been added to the **dispenser**.
- The baskets have been **correctly loaded**.
- The spray arms are able to **rotate freely** and without obstruction.
- The dishwasher door is **securely closed**.

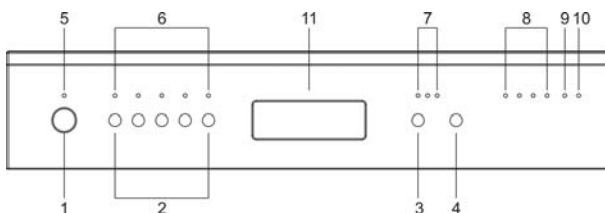
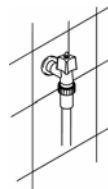

LIGHTING

When the **ON/OFF** button (1) is pressed, the dishwasher switches on and the light (5) comes on. About **2 seconds** later, the **PHASES/PROGRAM** lights (8) will come on.

PROGRAMMING

In this model of dishwasher, all programming procedures can only be carried out with the door closed. As long as the door is open, the **PROGRAMS** lights (6) and **PHASES/PROGRAM** lights (8) will remain off.



SELECTION PROGRAM

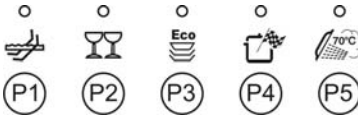

The program selection is possible through the relative buttons **(2)**.

When the button relating to the program required is pressed, the relative light will come on to confirm the operation.

To run the last four programs in the table, first select the “main” program **(P2, P3, P4, P5)** and then the soak program **P1**.



START PROGRAM

To start the dishwasher, press the **START/PAUSE** button **(4)** for a few seconds, until the light of the first phase of the selected program starts to flash (confirmation beep).

This phase, that updates itself during the cycle, is “indicative” since it is influenced by the washing conditions such as dishwasher type and quantity, entry temperature etc. For this reason it is normal to see the updating during a program (increment and decrease of minutes) specially in the passage from one phase to the other (for example, from washing to rinse).

As the program runs, the **PHASES/PROGRAM** lights **(8)** will indicate the current cycle status.

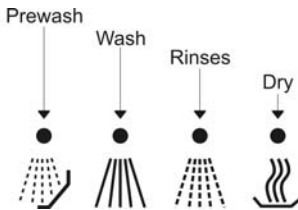

The light of the phase in progress will flash, while the lights of the previous and subsequent phases remain on.

N.B. during execution of programs which do not include a prewash, the first **PHASES/PROGRAM** light **(8)** will remain off.



END PROGRAM

When the program finishes, a buzzer sounds briefly and all the **PHASES/PROGRAM** lights **(8)** flash.

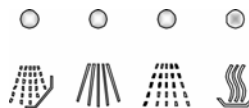

Press any of the **SELECTION PROGRAMS** buttons **(2)**, stops the light flashings, and the dishwasher is now ready to perform a new cycle; opening and shutting the door or switching the appliance off and on has the same effect.

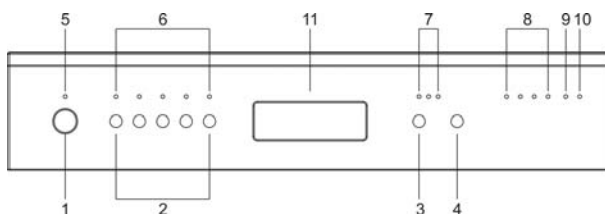

INTERRUPTION OF A PROGRAM

In order to interrupt a running program it is necessary:

- press the **START/PAUSE** button **(4)**, the light of the current phase goes out;
- keep the button pressed until the **PHASES/PROGRAM** lights **(8)** come on (confirmation buzzer).

TO CHANGE A PROGRAM

To change the running program it is necessary:

- to interrupt the running program (see “**INTERRUPTION OF A PROGRAM**”);
- select the new program;
- to press again the **START/PAUSE** button **(4)** to make start the new program.



ANNULLING A PROGRAM

To annul the program in progress, it must first be interrupted (see "INTERRUPTION OF A PROGRAM").

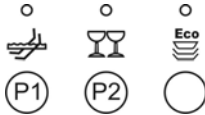

Now press buttons **P1+P2** simultaneously and the first three program lights will come on.



In case that the door is opened during the operation, to the next door closing it is going to be necessary to start the program as shown in paragraph "START PROGRAM". The program will resume from the point in which it was interrupted.

In case that the tub temperature is higher than 50°C the program will start about 30 seconds later.

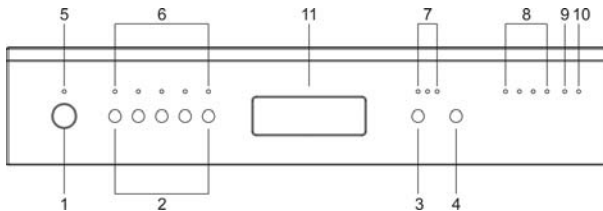

DELAY PROGRAM (on some models only) (available in all programs except the soak program)

The **PROGRAM DELAY** button (**3**) can be pressed to delay the start of the washing program by **3, 6 or 9 hours**. This function allows you to set the dishwasher to work at your preferred time of day.

After selecting the delay, start the program (see relative section). The appliance will prewash the dishes, after which the "program delay" set previously will come into effect (the light corresponding to **3, 6 or 9 hours** flashes).



To **reset or change the delay** once the program has started:

- press the **START/PAUSE** button (4) for a few seconds, until the **PHASES/PROGRAM** lights (8) come on;
- press the **DELAY PROGRAM** button (3) several times “until the program delay” returns to zero (all the lights indicating the delay go out);
- press the **START/PAUSE** button (4) to start the new program.

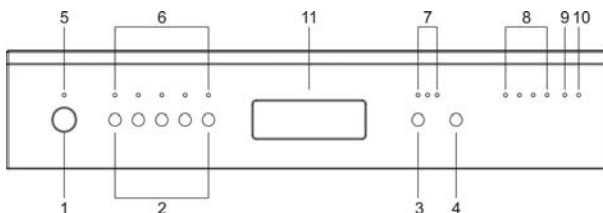

To **set the delay once the program has started**, proceed as follows.

If the program you wish to carry out is the same as the one already in progress:

- press the **START/PAUSE** button (5) for a few seconds, until the **PHASES/PROGRAM** lights (10) come on;
- annul the program in progress (see relative section) and wait for the cycle to come to an end;
- select the program again;
- select the delay required;
- press the **START/PAUSE** button (5) to start the new program.

If the program you wish to carry out is different from the one already in progress:

- press the **START/PAUSE** button (5) for a few seconds, until the **PHASES/PROGRAM** lights (10) come on;
- change the program;
- select the delay required;
- press the **START/PAUSE** button (5) to start the new program. The dishwasher will pump out the water and restart with the delay set and the new program.



TO SAVE ON ENERGY! ... AND PROTECT THE ENVIRONMENT

- Always try to run the dishwasher **fully loaded**.
- Do not wash the dishes in running water.
- Use the washing program that is **most appropriate** for each type of load.
- Do not carry out any preliminary rinsing.
- If available, connect the dishwasher to a hot water supply up to 60°C.
- When possible, **skip the drying cycle** by leaving the door open when the washing cycle is complete; the air and the residual heat will dry the dishes perfectly.

TO CUT DOWN ON DETERGENT CONSUMPTION! ... AND PROTECT THE ENVIRONMENT

The phosphates contained in dishwasher detergents are harmful to the environment. To avoid using excessive amounts of detergent and to save on electricity, observe the following:

- **separate** the more delicate items from dishes that are more resistant to aggressive detergents and high temperatures;
- **do not pour** the detergent directly on the dishes.

REMOVING THE DISHES

At the end of the washing program, wait at least **20 minutes** before removing the dishes, to allow them to cool down. To prevent any water droplets on the upper basket from falling on the dishes in the lower basket, it is **advisable** to unload the lower basket first, and then the upper basket.



4. Operating instructions

Once the dishwasher has been correctly installed, prepare for use as follows:

- Adjust the water softening system;
- Add the regenerating salt;
- Add the rinse aid and detergent.

4.1 Using the water softening system



The amount of scale contained in the water (water hardness index) can cause whitish staining on the dry dishes, which tend to become dull over time. The dishwasher is equipped with an automatic softening system which uses a special regenerating salt to reduce the hardness of the water.

The dishwasher is factory set for water hardness level **3** (average hardness **41-60°dF – 24-31°dH**).

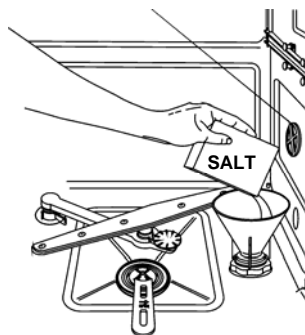

When using water of medium hardness, the regenerating salt container should be refilled after approximately **20 washing cycles**. The salt container can hold approximately **1.5 Kg** of salt in grains. The container is situated at the bottom of the dishwasher. After removing the lower basket, unscrew the salt container cap by turning it anticlockwise and pour in the salt using the funnel supplied with the dishwasher. Before replacing the cap, remove any salt residues from around the opening.



- *When using the dishwasher for the first time, in addition to the salt it is also necessary to add **one litre of water** to the container.*
- *Each time the salt container is refilled, make sure that **the cap is securely closed**. The mixture of water and detergent must never penetrate the salt container, as this would compromise the operation of the regeneration system. In the event of this occurring, the warranty will be invalidated.*
- ***Only** use regenerating salt specially formulated for domestic dishwashers. If using salt tablets, **do not fill the container completely**.*



- **Do not use table salt** as it contains insoluble substances which, over time, may damage the water softening system.
- When necessary, refill the regenerating salt container **before starting the washing program**. In this way, the excess saline solution will be immediately removed by the water; the prolonged presence of salt water inside the tank may lead to **corrosion**.



Be careful not to confuse the salt and detergent packages; adding detergent to the salt container will **damage** the water softening system.

ADJUSTING THE WATER SOFTENING SYSTEM

The dishwasher is equipped with an device for the user to adjust the water softening system according to the hardness of the water supply.

According to the machine model, the selector which acts on the adjustment may be located:

- inside the plastic locking ring located on the **right-hand** side, inside the dishwasher;
- inside the water softener, just below the cap.

Both allow for adjustment to **5** settings.

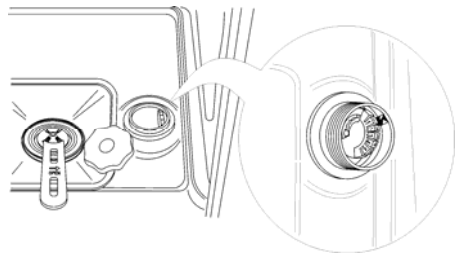
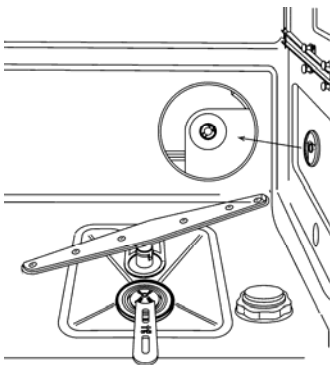



WATER HARDNESS TABLE

WATER HARDNESS		SETTING
German Degrees (°dH)	French Degrees (°dF)	
0 - 4	0 - 7	Setting N. 1 NO SALT
5 - 15	8 - 25	Setting N. 1
16 - 23	26 - 40	Setting N. 2
24 - 31	41 - 60	Setting N. 3
32 - 47	61 - 80	Setting N. 4
48 - 58	81 - 100	Setting N. 5

Contact your local water board for information on the hardness of your water supply.

4.2 Using the rinse aid and detergent dispensers

The detergent and rinse aid dispensers are situated on the inner part of the door: the detergent dispenser is on the left, and the rinse aid dispenser is on the right.

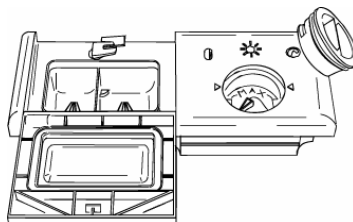

With the exception of the **SOAK** program, before every washing cycle it is necessary to add the required amount of detergent to the **detergent dispenser**. The rinse aid, on the other hand, should only be added as required.



ADDING THE RINSE AID

The rinse aid helps the dishes dry faster and prevents the formation of scale deposits and staining; it is automatically added to the water during the final rinse cycle, from the container situated on the inner side of the door.

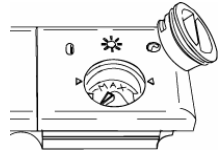

To add rinse aid:

- Open the door.
- Rotate the container cap anticlockwise by $\frac{1}{4}$ of a turn and remove it.
- Add the rinse aid until the container is full (approximately 140 cc). The optical level indicator on the side of the cap should be completely obscured. Refill the rinse aid when the optical level indicator becomes clear again, or when the rinse aid warning light illuminates.
- Replace the cover and turn it in a clockwise direction.
- Use a cloth to remove any spillage of rinse aid which might lead to the formation of excess foam.

ADJUSTING THE RINSE AID DISPENSER SETTING

The dishwasher is factory set for medium water hardness. However it possible to change the setting by turning the dispenser's selector to the desired position: the amount of rinse aid dispensed is proportional to the selector position.

- To adjust the rinse aid setting, rotate the dispenser cap through a quarter turn in an anticlockwise direction and remove it.
- Then use a screwdriver to rotate the rinse aid selector to the desired position.
- Replace the cap, turning it clockwise.



- *The amount of rinse aid must be **increased** if the washed dishes appear dull or feature circular stains.*
- *If, on the other hand, the dishes are sticky or have white streaks, it is necessary to **reduce** the rinse aid setting.*



ADDING THE DETERGENT

To open the detergent dispenser cap, lightly press the button **P**. Add the detergent and close the cap carefully.

During the washing cycle, the dispenser will be opened automatically.

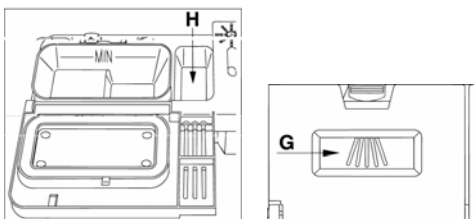
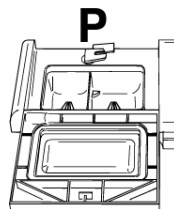

- When a program with hot prewash is selected (see program table), extra detergent must be placed in the cavity **G/H** (depending on models).
- Use **only** detergents specially formulated for dishwashers. For optimal washing results it is important to use a good quality detergent.
- The detergent packs must be sealed and stored in a dry place to prevent the formation of lumps which may negatively affect washing results. Once opened the detergent packs should not be kept for too long, otherwise the detergent loses its effectiveness.
- Do not use detergents formulated for washing dishes by hand, because they produce a great deal of foam and may negatively affect the operation of the dishwasher.
- Add the correct amount of detergent. An insufficient amount of detergent will result in a partial removal of dirt from the dishes, whereas an excessive amount is wasteful and does not improve the washing results.
- The market offers liquid and powder detergents with differing chemical compositions, which may contain **phosphates**, or be phosphate-free but contain **natural enzymes**.
 - Detergents containing **phosphates** are more effective against grease and starch at **temperatures above 60°C**.
 - **Enzyme** detergents, on the other hand, are also effective at lower temperatures (**from 40 to 55°C**) and are more easily biodegradable. With enzyme detergents it is possible to obtain at low temperatures comparable results to those which can only be achieved at **65°C** using traditional detergents.

For the safeguarding of the environment we recommend the use of **phosphate- and chlorine free** detergents.



- **"3/1" Products**

*If you wish to use detergents which already contain salt and rinse aid, check whether your dishwasher is fitted with the **"3/1 option button"** on the **"Controls description"** page and then refer to the section which explains how to use this function.*

*If the button is not provided, we recommend the use of conventional products (separate detergent, salt and rinse aid), because with conventional washing cycles **"3/1"** products might create problems such as a white deposit, poor drying results and residues left on dishes.*



The introduction of detergent into the rinse aid dispenser, even in liquid form, will damage the dishwasher.

4.3 General warnings and recommendations



Before using the dishwasher for the first time, it is advisable to read the following recommendations concerning dish types to be washed and their loading.

There are generally no constraints on the washing of domestic dishes, but in certain cases it is necessary to take their characteristics into account.

Before loading the dishes into the baskets it is necessary to:

- *remove coarse food remains: e.g. bones, fish-bones, etc. which may clog the filter or damage the wash pump.*
- *soak any pots or pans with burnt-on food remains on the bottom to facilitate removal, then load them into the LOWER BASKET.*

There is no need to pre-wash the dishes under running water before loading them into the baskets since this only wastes water.

Correct loading of the dishes helps ensure optimal washing results.

**WARNING!**

- *Make sure that the dishes are securely in place so that they cannot tip over or obstruct the rotation of the spray arms during the washing cycle.*
- *Do not place very small objects in the baskets as these could fall and obstruct the spray arms or the wash pump.*
- *Containers such as cups, bowls, glasses and pots should always be loaded with the opening facing downwards and with any cavities at an angle, to allow the water to drain out.*
- *Do not stack dishes or place them in such a way that they cover one other.*
- *Do not place glasses too close together because they may knock against each other and break, or there might be staining at the point where they touch.*

MAKE SURE that the items being washed are dishwasher-safe.

Items which are not dishwasher-safe:

- **Wooden dishes, pots or pans:** these may be damaged by the high washing temperatures.
- **Handcrafted items:** these are rarely suitable for washing in a dishwasher. The relatively high water temperatures and the detergents used may damage them.
- **Plastic dishes:** heat resistant plastic dishes must be washed in the upper basket.
- **Dishes and objects in copper, tin, zinc or brass:** these tend to stain.
- **Aluminium dishes:** items made from anodised aluminium may lose their colour.
- **Silverware:** silver items may stain.
- **Glass and crystal:** in general, glass and crystal objects can be washed in the dishwasher. However, certain types of glass and crystal may become dull and lose their clearness after many washings. Therefore, for these items we recommend using the least aggressive program available.
- **Decorated items:** the decorated objects available on the market are generally able to withstand washing in the dishwasher, although the colours may fade after a great many washes. If in doubt as to the fastness of the colours, it is advisable to wash just a few items at a time for approximately one month.



4.4 Using the baskets

The dishwasher has a capacity of **10 place-settings**, including serving dishes.

LOWER BASKET

The lower basket receives the full force of the lower spray arm, and should therefore be used for the “toughest” items with a heavier degree of soiling.

All types and combinations of loads are permitted, provided that the dishes, pots and pans are arranged with all the soiled surfaces exposed to the water jets coming from the bottom.



With fixed supports

The bottom basket is fitted with supports which can be lowered to make better use of the space available.



With tilting supports

LOADING THE LOWER BASKET

Carefully load flat plates, soup plates, dessert and serving dishes, positioning them vertically. Pots, pans and their covers must be loaded upside down. When loading soup plates and dessert bowls, be sure to leave a gap between them.

Loading examples:

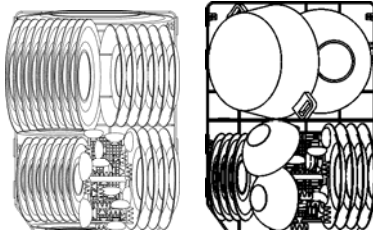



CUTLERY BASKET

The cutlery should be arranged in an orderly manner inside the basket, with the handles pointing downwards. Take care during loading to avoid injury from the knife blades. The basket is suitable for all types of cutlery, except those long enough to interfere with the upper spray arm. Ladles, wooden spoons and cooking knives can be placed in the upper basket, **making sure that the knife blades do not protrude from the basket.** The cutlery basket features an **exclusive system of independent sliding tip-up supports**, offering a choice of possible combinations to allow optimum use of the space available.

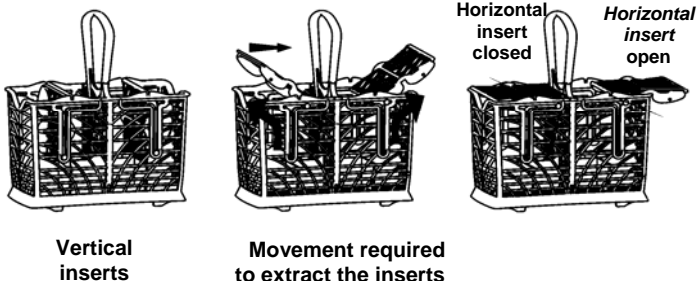

UPPER BASKET

It is recommended to load the upper basket with small- or medium-sized items such as glasses, small plates, tea or coffee cups, shallow bowls and light objects made from heat resistant plastic. If the upper basket is used in the lowermost position, it can also be loaded with serving dishes, provided they are only slightly soiled.

The basket is equipped with two tip-up cutlery supports which can be raised or lowered as required. See illustrations below.

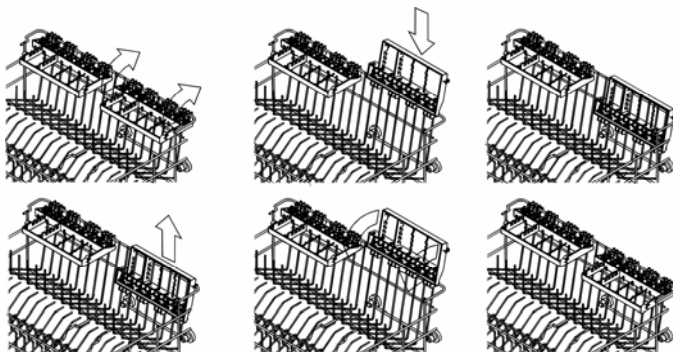



LOADING THE UPPER BASKET

Load plates facing forward; cups, bowls etc. must always be facing downwards. The left-hand side of the basket can be loaded with two layers of cups and glasses. On the right plates and saucers can be slotted vertically into the forks.

Loading examples:

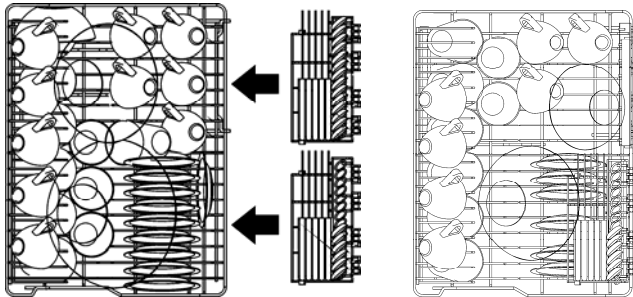

ADJUSTING THE UPPER BASKET

The upper basket can be adjusted in **two positions**, according to the user's needs and according to the height of the dishes in the lower basket.

Proceed as follows:

- turn the retainer **E** on both runners, right and left, through **90°**;
- remove the basket;
- lift the basket and fit the smaller pairs of wheels in the runners;
- return the retainers **E** to their original position.

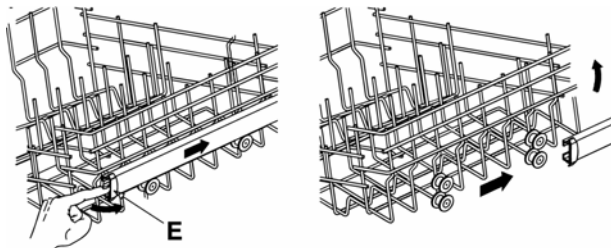



5. Cleaning and maintenance



Before carrying out any work, always unplug the appliance from the electrical supply or switch off the all-pole disconnection device.

5.1 General warnings and recommendations

Avoid the use of acidic or abrasive detergents.

Clean the outer surfaces and door-lining of the dishwasher regularly using a soft cloth moistened with water or with a normal detergent suitable for painted surfaces.

Clean the door gaskets with a damp sponge.

Periodically (once or twice a year) it is advisable to clean the tank and gaskets, using a soft cloth and water to remove any deposits.

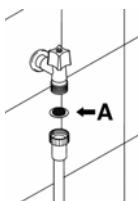

CLEANING THE WATER INTAKE FILTER

The water intake filter **A** located at the outlet of the water supply tap needs to be cleaned periodically.

After having closed the water supply tap, unscrew the end of the water intake hose, remove the filter **A** and clean it delicately under running water. Reassemble filter **A** in its seat and carefully screw the water intake hose back into position.

CLEANING THE SPRAY ARMS

The spray arms can be easily removed for periodic cleaning of the nozzles, to prevent possible clogging. Wash them under running water and carefully replace them in their seats, **checking that their rotary movement is in no way impeded.**

To remove the **upper** spray arm, unscrew locking ring **R**.

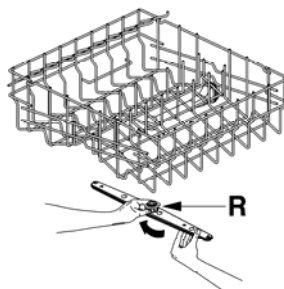



CLEANING THE SPRAY ARM, TRAVELLING VERSION

To remove the TRAVELLING spray arm, take hold of it and raise it to release both the spray arm and the pipe from the tank, then detach the spray arm from the pipe. Wash both the pipe and the spray arm in running water, re-attach the spray arm to the pipe and return the assembly to the seat provided in the tank.

Once the assembly has been put back in place, check that the spray arm turns freely (turn through a couple of revolutions by hand) and that the pipe is able to travel without impediments. Otherwise, check that it has been fitted correctly.



CLEANING THE FILTER UNIT

- The central filter **H** should be inspected regularly and cleaned if necessary. To remove it, take hold of the handle, turn anti-clockwise and lift.
- Press the central filter **H** from below to extract it from the micro-filter.
- Separate the two parts of the plastic filter by pressing the body of the filter in the zone shown by the arrows.
- Remove the central filter by lifting it.

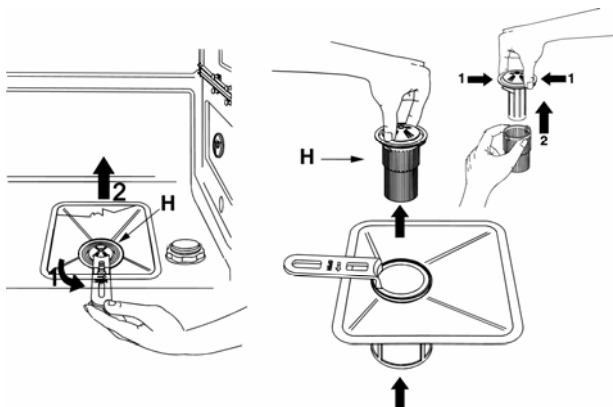



GENERAL WARNINGS AND RECOMMENDATIONS FOR CORRECT MAINTENANCE:

- The filters should be cleaned **under running water** using a stiff brush.
- **When removing the filter**, take care that there are no food residues on it. If any residues fall into the washing pit they might block hydraulic components, or foul the spray arm nozzles.
- It is essential to **thoroughly clean the filters** according to the above instructions: the dishwasher cannot function if the filters are clogged.
- **Carefully replace** the filters in their seats, to avoid damaging the wash pump.

PROLONGED DISUSE:

- Run the soak program twice in succession.
- **Unplug** the power cord from the socket.
- **Leave the door slightly open**, in order to prevent the formation of unpleasant odours inside the washing tank.
- **Fill the rinse aid dispenser**.
- **Shut off the water supply tap**.

BEFORE STARTING THE DISHWASHER AFTER PROLONGED DISUSE:

- Check that there are no deposits of sludge or rust inside the water pipe: if there are, allow the water to run from the water supply tap for a few minutes.
- **Plug the power cord** back into the socket.
- **Reconnect the water intake hose and open the tap again**.

TROUBLESHOOTING MINOR PROBLEMS

In some cases it is possible to remedy minor problems by referring to the following instructions:

If the program fails to start, check that:

- the dishwasher is connected to the electrical power supply;
- there is no power failure;
- the water tap is open;
- the dishwasher door is properly closed.

If water remains inside the dishwasher, check that:

- the drain hose is not kinked;
- the drain siphon is not obstructed;
- the dishwasher filters are not clogged.



If the dishes are not being cleaned properly, check that:

- the correct amount of detergent has been added;
- there is regenerating salt inside the special container;
- the dishes are being loaded correctly;
- the selected program is suitable for the dish types and their degree of soiling;
- all the filters are clean and positioned correctly;
- the spray arm nozzles are not obstructed;
- there is no object obstructing the rotation of the spray arms.

If the dishes fail to dry or remain dull, check that:

- there is rinse aid inside the special container;
- the rinse aid dispenser setting is correct;
- the detergent used is of good quality and has not lost its effectiveness (for example, through incorrect storage, with the box left open).

If the dishes show signs of streaking, staining, etc., check that:

- the rinse aid dispenser setting is not too high.

If there are visible traces of rust inside the tank:

- the tank is made of steel, and therefore any rust marks are due to external elements (fragments of rust from the water pipes, pots, cutlery, etc.). Special products are commercially available to remove such marks;
- check that the amount of detergent being used is correct. Certain detergents can be more corrosive than others;
- check that the cap of the salt container is securely closed, and that the water softening setting is correct.



If after following the above troubleshooting instructions the problem persists, call the nearest After-Sales Centre.

WARNING: any operations performed on the appliance by unauthorised persons are not covered by the warranty and shall be paid for by the user.



6. Troubleshooting

In case of a malfunction, the dishwasher will identify the program by switching on a combination of lights.

When an alarm is present, all the **PROGRAM** lights (6) come on, while the **PHASES/PROGRAM** lights (8) identify the error code:

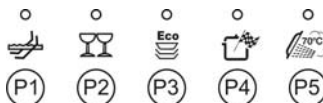

CODE	PHASES LIGHTS	DESCRIPTION
E1		The anti-flooding system (if installed) has been tripped.
E2		The system which limits the water level inside the dishwasher (safety unit) has been tripped.
E3		The appliance is not able to pump out the water.
E4		Temperature sensor disconnected.
E5		The appliance is not able to take in water.
E6		The appliance is not able to pump out the water from the tank.



User instructions



CODE	PHASES LIGHTS	DESCRIPTION
E7		The appliance is not able to measure the amount of water loaded accurately (on models with turbine flow-regulator only).
E8		Anomaly in the system which distributes water to the basket (where installed).
E9		The maximum level of water for loading has been exceeded (on models with turbine flow-regulator only).

- The **E1**, **E2**, **E3**, **E4**, **E8**, **E9** alarms provoke the “forcing” to end cycle of the running program.
- The **E5**, **E6** alarms interrupts the running program once the cause is resolved, it will bring bach the execution of the program.
- The alarm **E7** is visualized at the end of the cycle that comes, however, brought to the end since the operation of the dishwasher is not harmed.

To “reset” an alarm is necessary:

- Open and close the door, or turn off and on the machine. At this point is possible to program the dishwasher again.



If the fault persists, call the authorised Technical Service Centre.

TECHNICAL DATA

Width	497 ÷ 499 mm
Depth measured flush with the outer edge of the control panel	Free standing: 600 mm Semi-integrated: 570 mm
Height	Free standing: from 850 mm to 870 mm Semi-integrated: from 820 mm to 870 mm
Capacity	10 Standard place settings
Water supply pressure	min. 0,05 - max. 0,9 MPa (min. 0.5 – max. 9 bar)
Electrical characteristics	See rating plate

Misurare l'altezza del pannello di comando; fare coincidere l'indice relativo a tale valore con il profilo superiore della porta in legno; tracciare il posizionamento degli agganci porta.
 Measure the height of the control panel; bring the mark relating to this value into line with the top edge of the wooden door; mark the position of the door connections.
 Mesurer la hauteur du panneau de commandes; faire coïncider l'index relatif à cette valeur avec le profil supérieur de la porte en bois; tracer le positionnement des crochets de la porte.
 Die Höhe des Bedienfelds messen; Die diesen Wertentsprechende Markierung mit dem oberen Profiler der Holztür zur Deckung bringen; Die Position der Tür aufhängungen anzeichnen.
 Meet de hoogte van het bedieningspaneel; laat de markering die bij die waarde hoort overeenstemmen met het bovenste profiel van de houtendeur; tekende positieve van de deurhangers af.
 Medir la altura del panel de mandos; hacer coincidir el índice correspondiente a dicho valor con el perfil superior de la puerta de madera; trazar el posicionamiento de las bisagras de la puerta.
 Meça a altura do painel de comandos; faça com que o indicador relativo a este valor coincida com o perfil superior da porta de madeira; marque a posição dos ganchos para a porta.

115
125
135
145
155

115
125
135
145
155

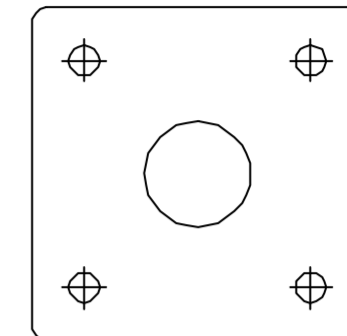
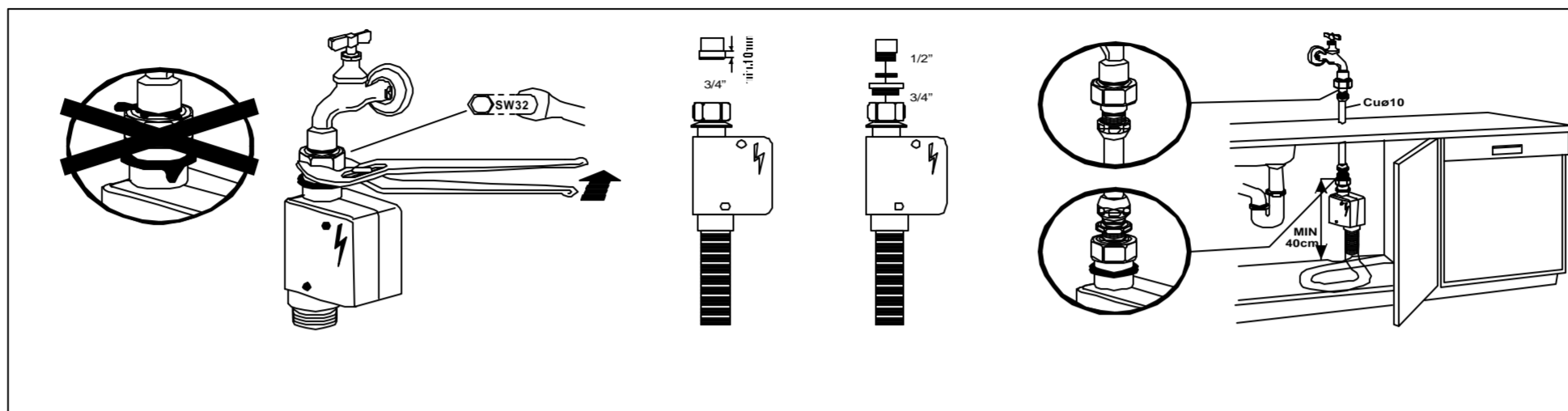
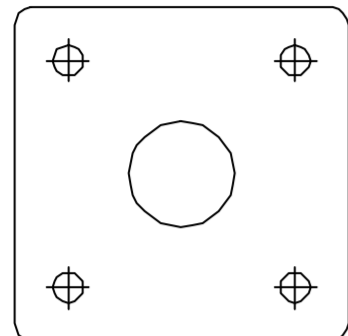

19 570 0054 02

Sicurezza contro gli allagamenti

Questo sistema di sicurezza protegge il vostro appartamento da danni dell'acqua. In caso di guasto al tubo di entrata o permeabilità del sistema della macchina, l'entrata dell'acqua viene interrotta. La scatola della sicurezza anti-allagamento montata sul tubo, contiene parti elettriche. E' pertanto proibito collocare la scatola stessa nell'acqua. Nel caso in cui per una ragione qualsiasi la scatola subisca danni, togliere immediatamente la presa di collegamento dalla rete elettrica.

HR AQUASTOP - Zаштита pred poplavom

Ovaj sigurnosni sistem štiti vaš stan od štete koju može uzrokovati voda. U slučaju kvara na dovodnoj cijevi ili u slučaju propuštanja na sistemu stroja za pranje posuđa, prekida se dovod vode. Kućište ventila, odnosno sigurnosne naprave, namješteno na cijevi, sadrži električne dijelove. Zato je ne smijete potopiti u vodu. U slučaju da se kućište iz bilo kojeg razloga ošteti, odmah isključite aparat iz električne mreže.

Aquastop safety device

The AQUASTOP is safety device. The aquastop assures that the fresh water hose need only take the stress of water pressure during the actual timer water is flowing. If the hose should begin to leak during this time, the magnetic valve in the water spout cuts off the flow, and the hose is relieved of pressure. Operating pressure DIN 44995. The valve casing on the water-stop hose contains electrically controlled components. It is should not, therefore, be submerged in water. If the housing becomes damaged the plug must be removed from the socket.

МК AQUASTOP - Заштита од поплава

Ovaj zaštitni sistem štiti vaš stan od poplave. U slučaju na oštećenje na dovodnoj cijevi ili pak u slučaju propuštanja sistem na mašinu za mičeње sadovi, se prekine dovod na voda. Kućište na ventila odnosno na sigurnosna naprava koja e namještena na cijevi, sadrži električni dijelovi i zato ne smijete da je potopite u vodu. Ako se slučaj od bilo kakvi pričini kućište da se ošteti, aparat vedanaš isključite go od električnata mreža.

Paliers de sécurité pour empêcher les fuites

Le système est doté de sept paliers de sécurité pour éviter les fuites d'eau et protéger ainsi votre logement contre d'éventuels dégâts matériels. Si le tuyau d'arrivée d'eau n'est pas étanche ou si la machine fuit, ce dispositif arrête l'écoulement d'eau. Le boîtier de sécurité qui contrôle l'arrivée d'eau est situé sur le tuyau et contient des parties électriques. Il ne faut donc pas le tremper dans l'eau. S'il est endommagé pour une raison quelconque, débranchez immédiatement l'appareil en retirant la prise.

SLO AQUASTOP - Zаштита pred poplavo

Ta varnostni sistem varuje vaše stanovanje pred škodo, ki bi jo povzročila voda. V primeru okvare na dovodni cevi ali v primeru puščanja na sistemu pomivalnega stroja, se prekine dovod vode.

Ohišje ventila oz. varnostne naprave, ki je namješeno na cevi, vsebuje električne dele. Zato je ne smete potopiti v vodu. V primeru, da se ta skatla iz kakršnegakoli razloga poškoduje, nemudoma izklopite aparat iz električnega omrežja.

Aquastop

Dieses Wasserschutz-System schützt ihre Wohnung zuverlässig vor Wasserschaden. Bei undichtigem Wasserzulaufschlauch oder undichtem Maschinensystem wird jeglicher weiterer Wasserzulauf unterbunden. Der Ventilkasten am Wasserstop Schlauch beinhaltet elektrisch gesteuerte Bauteile. Er darf deshalb nicht in Wasser getaucht werden. Sollte das Ventilkastengehäuse beschädigt sein, ist unbedingt der Netzstecker aus zu ziehen.

Aquastop-Verlängerung

Im Handel können längere Aquastopschläuche gekauft werden, die von einem Fachmann mit dem bestehenden Aquastopschlauch ausgetauscht werden müssen. Bei einer eigenmächtigen Verlängerung des Wasserzufuhrschlauches trägt der Hersteller keine weitere Verantwortlichkeit.

"Aquastop" por septuplicado

El sistema "AQUASTOP" por septuplicado protege su vivienda de forma fiable e de danos por escapes de agua. Se corta inmediatamente el suministro de agua en caso de cualquier fuga en tubos o en componentes del aparato. El cajón de válvulas del tubo aquastop contiene componentes eléctricos. Por este motivo no debe sumergirse en agua. En caso de que el cajón de válvulas estuviera dañado, debe desconectarse de la red eléctrica, desenchufando la clavija.

YU AQUASTOP - Заштита пред поплавом

Ovaj bezbednosni sistem štiti vaš stan od štete koju može da uzrokuje voda. U slučaju kvara na dovodnoj cijevi ili u slučaju prekida se o voda vode. Kućište ventila odnosno bezbednosne naprave, montirane na cijevi, sadrži električne dijelove. Zato nesmete da je potopiate u vodu. U slučaju da se kućište iz bilo kog razloga ošteti, odmah isključite aparat iz električne mreže.

ATTENZIONE: Quota "H": secondo i modelli 820÷870 oppure 820÷890. CAUTION: Depending on the model, distance "H" maybe 820÷870 or 820÷890. ATTENTION: Cote "H": selon les modèles 820÷870 ou 820÷890. ACHTUNG: Maß "H": gemäß den Modellen 820÷870 oder 820÷890. LETOP: Hoogte "H": voor de modellen 820÷870 of 820÷890. ATENCIÓN: Cota "H": según los modelos 820÷870 o bien 820÷890. ATENÇÃO: Cota "H": dependendos dos modelos 820÷870 ou 820÷890.

