

Operating instructions

Professional dishwasher  
G 8050 / PG 8050i

---

To prevent accidents  
and machine damage  
read these instructions

**before**  
installation or use.

en - CA, US

M.-Nr. 07 950 142

# Contents

---

<b>Safety instructions and warnings</b> . . . . .	4
<b>Guide to the machine</b> . . . . .	9
Overview . . . . .	9
Control panel G 8050 . . . . .	10
Control panel PG 8050i . . . . .	11
<b>Before using for the first time</b> . . . . .	12
Before using the machine for the first time you will need: . . . . .	12
<b>Opening and closing the door</b> . . . . .	13
To open the door . . . . .	13
To close the door . . . . .	13
Child safety lock . . . . .	13
<b>Water softener</b> . . . . .	14
Filling the salt reservoir . . . . .	16
Recharge indicator . . . . .	17
<b>Rinse aid</b> . . . . .	18
Filling the rinse aid reservoir . . . . .	18
Rinse aid indicator . . . . .	19
Setting the rinse aid dosage . . . . .	19
<b>Use</b> . . . . .	20
Loading the machine . . . . .	20
Items not recommended for dishwashing . . . . .	21
Upper basket . . . . .	22
Adjusting the upper basket . . . . .	23
Lower basket . . . . .	24
Lower basket inserts . . . . .	25
Removing an insert . . . . .	25
Inserting an insert . . . . .	25
Adding detergent . . . . .	26
Turning on . . . . .	28
Selecting a program . . . . .	28
Program sequence indicators . . . . .	29
Display . . . . .	29
At the end of a program . . . . .	30
Interrupting a program . . . . .	31
Changing a program . . . . .	31
<b>Program Guide G 8050</b> . . . . .	32
<b>Program Guide PG 8050i</b> . . . . .	34

<b>Options</b> . . . . .	36
Start delay . . . . .	36
Extra Drying . . . . .	37
<b>Programming special functions</b> . . . . .	38
Dispensing system settings for DOS Module G 60 Semi (optional extras) . . . . .	38
To access the DOS programming level . . . . .	38
Setting the dosage . . . . .	39
Venting the dispensing system. . . . .	39
Special function 1 Setting the rinse temperature. . . . .	40
Special function 2 Increasing the water level . . . . .	42
Special function 3 Display time or temperature. . . . .	44
Special function 4 Actual temperature display . . . . .	46
Special function 5 Setting the heating power . . . . .	48
<b>Cleaning and care</b> . . . . .	50
Cleaning the water inlet filter . . . . .	54
Cleaning the drain pump and non-return valve . . . . .	55
<b>Frequently asked questions</b> . . . . .	56
Technical faults . . . . .	56
Poor cleaning results . . . . .	59
Other faults . . . . .	61
<b>After sales service</b> . . . . .	62
<b>Installation instructions</b> . . . . .	63
<b>Installation</b> . . . . .	64
<b>Electrical connection</b> . . . . .	67
<b>Plumbing</b> . . . . .	69
Water inlet . . . . .	69
Drainage . . . . .	70
<b>Technical data</b> . . . . .	71
<b>Help to protect the environment</b> . . . . .	72

# Safety instructions and warnings

---

This commercial dishwasher complies with all applicable safety laws and regulations. However, inappropriate use can result in personal injury and property damage.

These operating instructions contain important information on the installation, operation and care of your commercial dishwasher. To avoid the risk of personal injury or damage to the commercial dishwasher, it is important that you carefully read these instructions before use.

Keep them in a safe place and pass them on to any future owner.

## Proper use

▶ Use this commercial dishwasher only for the purpose of dishwashing, as indicated in the instructions. Any other use, conversions or modifications are impermissible and possibly hazardous. The manufacturer will not be held liable for damage caused by inappropriate use or improper operation.

▶ Operating personnel must receive training regularly. Untrained personnel must not be permitted to work with the commercial dishwasher.

▶ Individuals who are incapable of using this commercial dishwasher safely because of physical, sensory or mental factors, or their inexperience or lack of knowledge, should not use this commercial dishwasher without supervision or instruction by a responsible person.

▶ The special inserts are to be used only for their specific application.

## Technical safety

▶ Before installing the commercial dishwasher, check for externally visible damage. A damaged commercial dishwasher must never be placed into operation. A damaged commercial dishwasher can jeopardize your safety.

▶ The electrical safety of this commercial dishwasher can be ensured only when it has been properly grounded in compliance with applicable safety regulations. It is imperative that this basic safety requirement be met. In case of doubt, have the electrical system checked by a qualified technician.

The manufacturer will not be held liable for damage or injury (such as electric shock) caused by a missing or broken protective grounding conductor.

▶ Be sure to follow the installation instructions in this manual and in the installation diagram.

▶ Before connecting the commercial dishwasher, it is imperative to compare the connection data (voltage and frequency) on the data plate with those of the electrical network.

These data must agree, if damage to the unit is to be prevented. If in doubt, ask a qualified electrician.

## Safety instructions and warnings

- ▶ Installation, maintenance and repairs should be performed only by technicians authorized by the manufacturer.  
Improper installation and maintenance or repairs can pose significant hazards to the user; note that the manufacturer will not be held liable for such hazards.
- ▶ If the power cord is damaged, a special cord must be installed by a Miele-authorized technician.
- ▶ The commercial dishwasher should only be placed into operation and serviced by Miele Customer Service, an authorized Miele dealer or a qualified technician.
- ▶ To ensure safe operation, use the commercial dishwasher only after it has been correctly installed into place.
- ▶ NEVER open the commercial-dishwasher housing. Any contact with live connections or any changes to the electrical or mechanical setup will endanger you and may impair the functioning of the commercial dishwasher.
- ▶ Defective components should be replaced by Miele original parts only. Only these parts are guaranteed by the manufacturer to comply with safety requirements.
- ▶ Do not connect the commercial dishwasher to the power supply by means of an extension cord or power strip, as these do not guarantee the required safety of the commercial dishwasher (and could cause overheating, for example).
- ▶ A damaged commercial dishwasher can jeopardize your safety. Immediately shut down the damaged commercial dishwasher and notify Miele Customer Service, an authorized Miele dealer or a qualified technician.
- ▶ Before performing installation and maintenance work or repairs, the commercial dishwasher must be disconnected from the power supply. The commercial dishwasher is NOT disconnected from the power supply unless one of the following conditions is met:
  - The fuses or circuit breakers are tripped.
  - The screw-in type fuses are fully unscrewed.
  - The power cord is disconnected from the electrical system.  
To disconnect a commercial dishwasher with a plug, grasp the plug itself and pull. Do not pull on the power cord.

# Safety instructions and warnings

---

## Proper use

► Repair of the commercial dishwasher during the warranty period should be performed only by a customer service center authorized by the manufacturer, otherwise any damage will not be covered by the warranty.

► Always exercise care when handling liquid cleaning agents or additives. Some of these products contain corrosive and irritating substances. NEVER use organic solvents since there is a risk of explosion. ALWAYS observe the applicable safety regulations. Use safety glasses and gloves. Always follow the manufacturer's safety recommendations when using chemical additives.

► The water in the wash cabinet is NOT safe to drink.

► Avoid inhaling powdered cleaning agents. If detergents are swallowed, this can result in chemical burns to the mouth and throat or even suffocation.

► Certain pre-treatments (for example, that contain detergents), as well as, certain contaminants and some dishwashing liquids, can generate foam. Foam can adversely affect the cleaning performance.

► The recommendation to use chemical additives (such as cleaning agents) does not mean that the washer manufacturer accepts liability for how these chemical additives may affect the wash load.

Note that formulation changes, storage conditions, etc., not disclosed by the manufacturer, may alter the cleaning results obtained.

► When using cleaning agents and special-purpose products, comply strictly with the instructions of the respective manufacturer. In order to avoid possible chemical reactions (such as explosive hydrogen gas reactions), use cleaning agents only for the applications intended by the manufacturer.

► The commercial dishwasher is designed only for operation with water and additive cleaning agents. Organic solvents must NOT be used in the appliance, as there is the danger of explosion and/or damage. (Note: Although many organic solvents do not involve a danger of explosion, they may still cause other problems, such as the destruction of rubber and plastics.)

► For critical applications, where very high processing-quality requirements have to be met, it is strongly recommended that all process-related factors (cleaning agents, water quality, etc.) be discussed in advance with Miele's Application Technology.

## Safety instructions and warnings

- ▶ Ensure that no appreciable residues of solvents or acids, and especially of hydrochloric acid or chloride solutions, are introduced into the wash cabinet along with the wash load. This also applies for corrosive ferrous material. Solvents combined with contaminants (especially from hazard class A1) should be present in trace amounts only.
- ▶ To avoid corrosive damage, make sure the stainless steel housing (if present on your model) does not come into contact with solutions/steam containing hydrochloric acid.
- ▶ After work has been performed on the supply plumbing, the supply line to the commercial dishwasher must be vented. Failure to do so can result in damage to the water-intake components.
- ▶ NEVER hose down the commercial dishwasher or the immediate vicinity, for instance with a water hose or pressure washer.
- ▶ Do not stand or sit on the open door, as this could damage the commercial dishwasher or cause it to tip over.
- ▶ Be aware of the potential for injury when utensils with sharp, pointed ends are placed upright, and position them so they cannot cause injury.
- ▶ When operating the commercial dishwasher in the upper temperature range, proceed with caution. Be aware of the danger of scalding or burning when opening the door. Allow baskets and inserts to cool off. Empty any hot water remaining in hollow items into the wash cabinet.
- ▶ When opening the door during or after the end of the program, take care not to touch the heating elements or heated surfaces on the floor of the wash cabinet. They remain hot for quite a few minutes after the program has ended and can cause burns.
- ▶ Empty all hollow items before loading them.

# Safety instructions and warnings

---

## Proper installation

▶ The installation and operation of this commercial dishwasher in non-stationary locations should be performed by specialized technicians only and then only if they ensure that the requirements for the safe use of the appliance have been met.

▶ Do NOT install the commercial dishwasher in an area where there may be the danger of explosion or freezing.

▶ To ensure the stability of under-counter dishwashers and integrated under-counter dishwashers, they must only be installed beneath a continuous worktop that is bolted to the adjacent cabinetry.

## Children in the vicinity

▶ Always supervise any children in the vicinity of the commercial dishwasher. Never allow children to play with the commercial dishwasher.

▶ Children must only be allowed to use the commercial dishwasher without supervision if the operation of the dishwasher has been explained to them in such a way that they can safely operate it. Children must be able to recognize the potential hazards of improper operation.

▶ Do not allow small children to play with the commercial dishwasher or to operate it. Among other hazards, children run the risk of locking themselves in the dishwasher.

## Accessories

▶ Accessories may only be attached or installed if they have been expressly approved by Miele. If other parts are attached or installed, claims under the warranty and/or product liability become null and void.

▶ Whatever the application, only Miele accessories should be connected to this machine. Miele application advisors can provide you with the item names and numbers for accessories.

## Disposal of the commercial dishwasher

▶ For safety and environmental protection, dispose of all detergent residues in compliance with safety regulations (use safety glasses and gloves).

Remove or destroy the door latch to prevent children from locking themselves inside. Then dispose of the commercial dishwasher properly (see: Caring for the environment).

For commercial dishwashers with a tank system, the water must first be drained from the tank.

The manufacturer will not be held liable for damage caused by failure to comply with the safety instructions and warnings.



## Overview

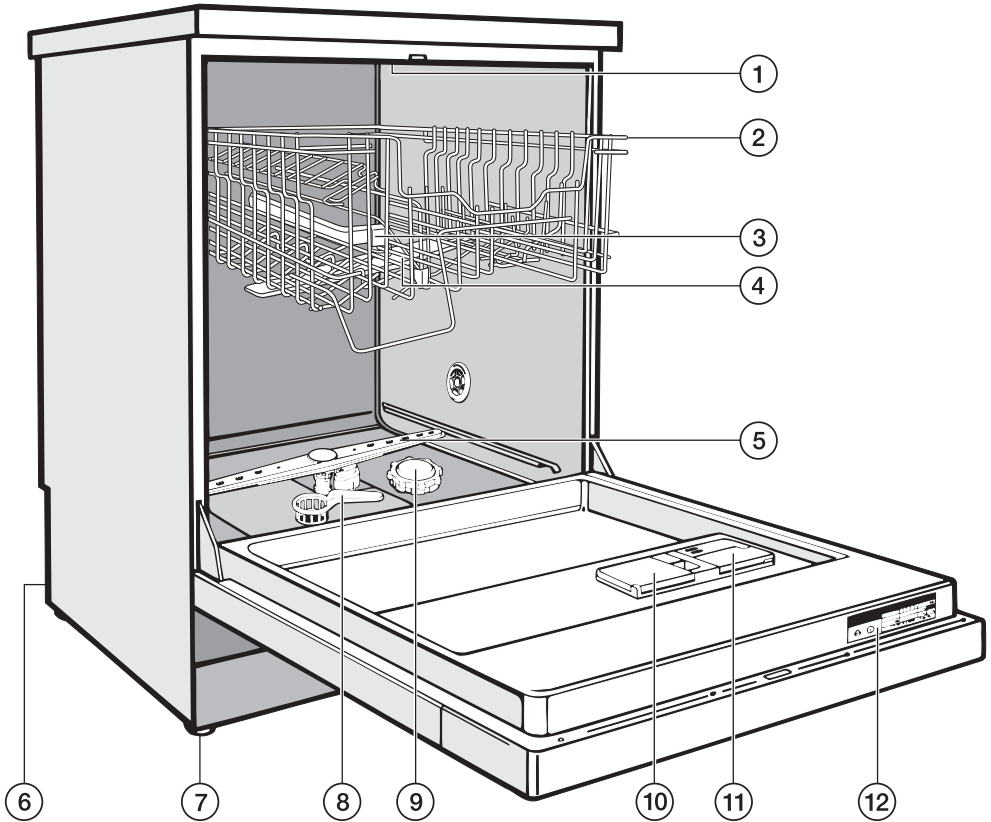

- ① Upper spray arm (not visible)
- ② Upper basket
- ③ Water feed for middle spray arm
- ④ Middle spray arm
- ⑤ Lower spray arm
- ⑥ Connection for DOS G 60 Semi module

- ⑦ Four height adjustable feet
- ⑧ Triple filter
- ⑨ Salt reservoir
- ⑩ Dual compartment detergent dispenser
- ⑪ Rinse aid reservoir (with dosage selector)
- ⑫ Data plate

# Guide to the machine

## Control panel G 8050

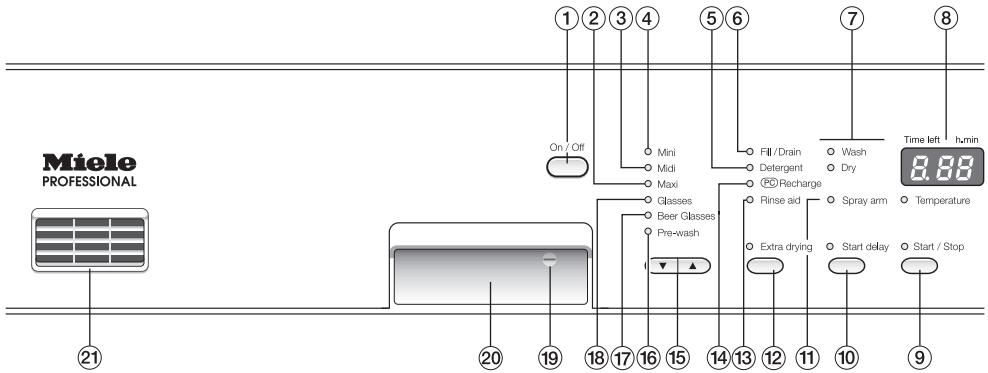

- ① On/Off button
- ② Maxi program indicator
- ③ Midi program indicator
- ④ Mini program indicator
- ⑤ Add detergent indicator (only applies to machines fitted with an optional external DOS G60 Semi module)
- ⑥ Check water inlet/drain indicator
- ⑦ Program sequence indicators
- ⑧ Display
- ⑨ Start/Stop button
- ⑩ Start delay button
- ⑪ Check spray arm indicator
- ⑫ Extra drying button
- ⑬ Add rinse aid indicator
- ⑭ Add salt (Recharge) indicator
- ⑮ Program selection buttons
- ⑯ Pre-wash program indicator
- ⑰ Beer Glasses program indicator
- ⑱ Glasses program indicator
- ⑲ Child safety lock
- ⑳ Door release
- ㉑ Ventilation outlet for drying fan

## Control panel PG 8050i

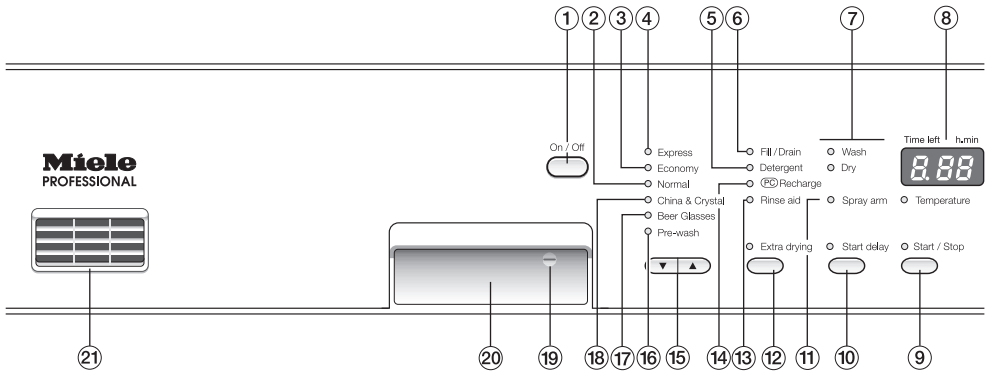

- ① On/Off button
- ② Normal program indicator
- ③ Economy program indicator
- ④ Express program indicator
- ⑤ Add detergent indicator (only applies to machines fitted with an optional external DOS G60 Semi module)
- ⑥ Check water inlet/drain indicator
- ⑦ Program sequence indicators
- ⑧ Display
- ⑨ Start/Stop button
- ⑩ Start delay button
- ⑪ Check spray arm indicator
- ⑫ Extra drying button
- ⑬ Add rinse aid indicator
- ⑭ Add salt (Recharge) indicator
- ⑮ Program selection buttons
- ⑯ Pre-wash program indicator
- ⑰ Beer Glasses program indicator
- ⑱ China & Crystal program indicator
- ⑲ Child safety lock
- ⑳ Door release
- ㉑ Ventilation outlet for drying fan

## Before using for the first time

---

### **Before using the machine for the first time you will need:**

- 2 liters of water,
- 2 kg of dishwasher reactivation salt,
- detergent for commercial dishwasher, and
- rinse aid for household dishwasher.

Every dishwasher is tested at the factory. There may be residual water in the machine from this test. This is not an indication that it has been previously used.

# Opening and closing the door

## To open the door

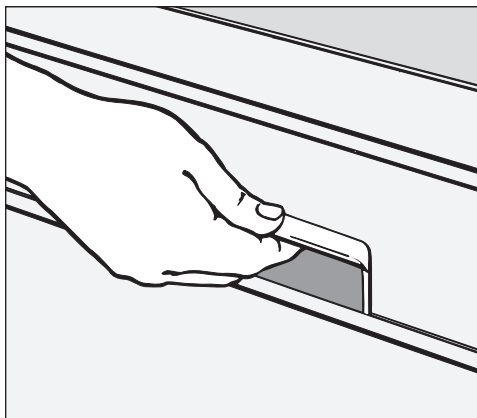

- Press the release catch inside the door grip and pull forward.

If the door is opened during operation all functions are automatically interrupted.

## To close the door

- Push the baskets in, lift the door and push until it clicks into position.

## Child safety lock

The yellow key for the child safety lock is on one of the spikes in the front of the upper basket. Remove the key before using the dishwasher and keep it in a safe place away from the dishwasher.

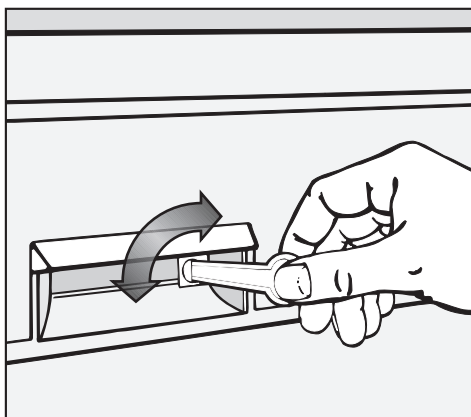

To prevent children from opening the dishwasher door during operation, use the key to lock the door.



Horizontal setting:  
The door is locked.



Vertical setting:  
The door can be opened.

# Water softener

In order to achieve good cleaning results, the dishwasher needs to operate with soft water. Hard water results in the build-up of calcium deposits on cookware and in the dishwasher.

Water with a hardness level higher than 4 gr/gal (4° d – German scale) needs to be softened. This takes place automatically in the integrated water softener.

- The water softener requires dishwasher reactivation salt.
- The dishwasher must be programmed for the water hardness in your area.
- Your local water authority can advise you of the water hardness level in your area.

Where the water hardness fluctuates e.g. between 8 - 18 gr/gal (8 - 17 °d German scale) always program the dishwasher to the higher value (17°d in this example).

If the water in your area is very soft and consistently **lower than 4 gr/gal (4 °d)** you do **not need to add dishwasher salt**. The salt indicator, however, will still come on, but should be ignored.

Local water hardness:

\_\_\_\_\_ gr/gal or °d

## The dishwasher is programmed at the factory for a water hardness level of 20 gr/gal (19 °d).

If this setting corresponds with the hardness of your water, continue with "Rinse aid".

If your water is harder or softer, you will need to program the water hardness level using the buttons on the control panel.

The programming can be canceled at any time by pressing the "On/Off" button. The procedure can then be restarted.

## Checking the programmed water hardness level

- Turn the dishwasher off with the "On/Off" button.
- **Press and hold** the "Extra drying" and "Start / Stop" buttons in and turn the dishwasher on with the "On/Off" button.
- Release the buttons.

The hardness level set will flash in the display.

The digit sequence after the *H* indicates the hardness level set in °d.

- Turn the dishwasher off with the "On/Off" button.

## Settings

°d German scale	gr/gal	Value displayed
1	1	1
2	2	2
3	3	3
4	4	4
5	5	5
6	6	6
7	7	7
8	8	8
9	9	9
10	10	10
11	11	11
12	12	12
13	13	13
14	14	14
15	16	15
16	17	16
17	18	17
18	19	18
19	20	19
20	21	20
21	22	21
22	23	22
23	24	23
24	25	24
25	26	25
26	27	26
27	28	27
28	29	28
29	30	29
30	31	30
31	32	31
32	33	32
33	34	33
34	35	34
35	36	35
36 - 70	37 - 73	36

## Setting the water softener

■ Turn the dishwasher off with the "On/Off" button.



■ **Press and hold** the "Extra drying" and "Start / Stop" buttons, at the same time turn the dishwasher on with the "On/Off" button.

■ Release the buttons.

The "Wash" indicator will come on and the "Recharge" indicator will flash.

If this does not happen, restart the procedure.

If **A 19** flashes in the timer display the water hardness level has been set to 20 gr/gal (19 °d).

■ Use the program selection buttons   to select the value that corresponds to your water hardness level.

 = to select a lower value.

 = to increase the value.

The selected two digit value will flash in the display.

■ Press the "Start/Stop" button twice.

The indicator beside the "Start / Stop" button will flash.

The programmed water hardness level is now stored into memory.

■ Turn the dishwasher off with the "On/Off" button.

# Water softener

## Filling the salt reservoir

Only special, coarse-grained reactivation salt\* should be used in this machine.

\*Available from Miele. Please see back page for more information.

Do not use other types of salt, e.g. table salt, agricultural or gritting salt. These could contain components which are insoluble in water and could damage the water softener. If in doubt consult the Miele Professional Department.

The salt reservoir holds about 2 kg of salt.

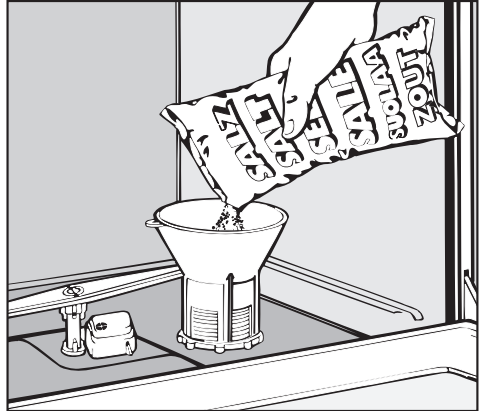

- Place the supplied funnel over the salt reservoir.
- Carefully fill with reactivation salt.

Displaced water will run out as it is being filled.

 Inadvertently filling the salt reservoir with detergent will damage the water softener. Before filling, make sure that you are using **reactivation salt**.

- Remove the lower basket.
- Unscrew the salt reservoir cap.

 **Filling the salt reservoir with salt for the first time:**

Fill the reservoir with approx. 2 liters of water first.



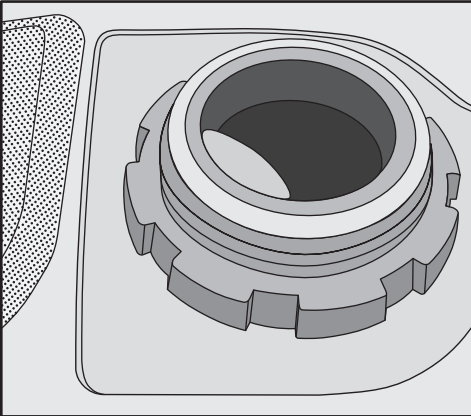

- Clean any excess salt from the thread and seal.
- Screw the cap on firmly.
- Close the door.
- Immediately run the "Pre-wash" program to remove any traces of salt from the cabinet.

## Recharge indicator

The reactivation salt needs to be replenished when the "Recharge" indicator lights.

- Fill / Drain
- Detergent
- ➔ ○ (PC) Recharge
- Rinse aid

After the reservoir has been filled, the water softener is automatically reactivated the next time the dishwasher is run. The salt indicator may still light during this process. It will go out once the salt concentration has reached the correct level.

## Rinse aid

Rinse aid is needed to prevent spotting on dishes and glassware. The rinse aid is filled in the reservoir and the set amount will be automatically dispensed during the final rinse.

 Inadvertently filling the rinse aid reservoir with powder or liquid detergent will damage the reservoir. Only pour rinse aid formulated for household dishwashers into the reservoir.

### Filling the rinse aid reservoir

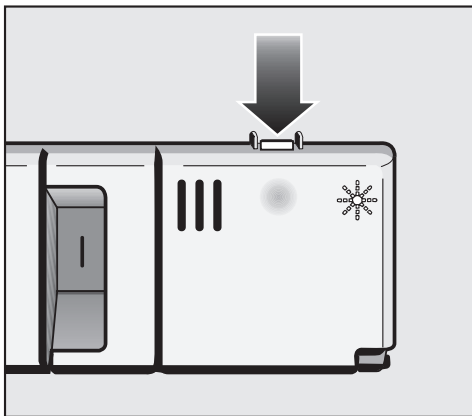

- Press the button of the rinse aid reservoir flap in the direction of the arrow until the flap springs open.

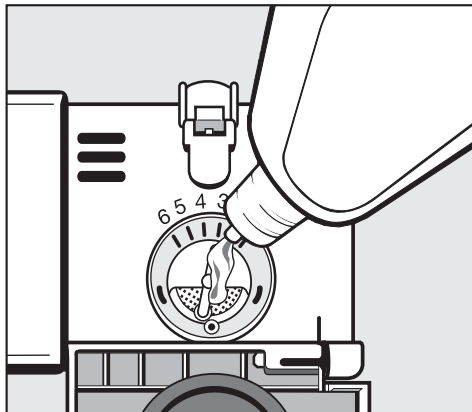

- Add rinse aid until it is visible on the surface of the filter in the opening.

The rinse aid reservoir holds approx. 130 ml.

- Close the flap firmly so that it clicks into place otherwise, water will enter the rinse aid reservoir during the program.
- Clean up any spilled rinse aid. This prevents over-foaming from occurring during the next program.

## Rinse aid indicator

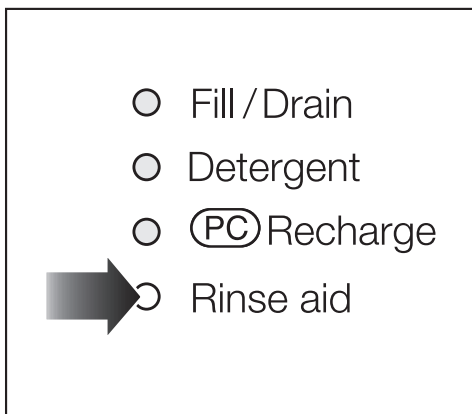

- Fill the rinse aid reservoir when the "Rinse aid" indicator comes on. There will be enough rinse aid left for 2 - 3 wash programs.

## Setting the rinse aid dosage

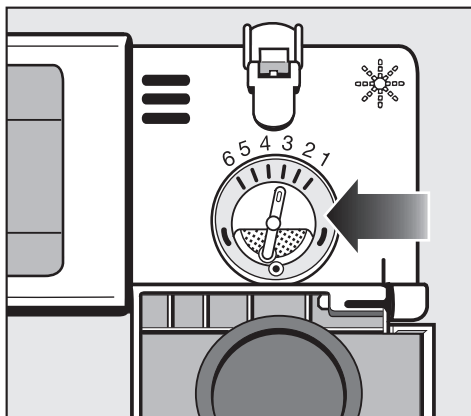

The dosage selector has settings from 1-6. It is factory set to the recommended setting "3" (3 ml). Approx. 3 ml of rinse aid are used per program.

### If spots appear on cookware and glassware

- Use a higher setting.

### If clouding or smearing appears on cookware and glassware

- Use a lower setting.

# Use

---

## Loading the machine

### Removing excess soils

- Scrape food from dishes before placing them in the dishwasher. Inadequate pre-cleaning can clog the filters and interrupt the wash program.

### Important

- Select baskets and inserts which are appropriate for the application.
- Load items so that water can reach all surfaces.
- Do not place dishes or cutlery inside other pieces.
- Hollow items such as cups, glasses, pots, etc. should be placed upside down in the respective inserts. Hollow vessels should be inverted and placed in the correct inserts.
- Concave based items such as mugs or bowls, should be placed at an angle so that water does not pool.
- To ensure good water coverage, tall, narrow and hollow items should be placed in the center of the baskets rather than in the corners. Do not obscure them with larger items below.
- The spray arms must not be blocked by items that are too tall or hang through the baskets. Check clearance by manually rotating the spray arms.

- Small items should be placed on the cup racks in the upper basket. Do not obscure them with larger items below, e.g. place bowls on the rack above the cups so that water reaches all items.
- Do not place very tall items in the front right hand area of the lower basket as these would prevent the detergent dispenser lid from opening.
- Cutlery can be placed in any order in the cutlery holders however, for the best cleaning and drying results, place the cutlery in the inserts with the handles down.

 Be careful when sorting items with sharp pointed ends. Position them in the machine so that you do not hurt yourself or create a danger for others. Sharp knives, forks, etc. should be placed in baskets with the pointed ends facing downwards.

## Items not recommended for dishwashing

- Cutlery with wooden or bone handles.
- Wooden or plastic cutting boards.
- Plastic items that are not heat resistant.
- Glued items, e.g. old knives with handles which have been glued on.
- Hand-made craft items, antiques, valuable vases and decorative glassware.
- Copper, brass, tin and aluminum items may discolor or become matt.
- Colors painted over a glaze may fade after a number of washes.
- Clouding may occur on glasses after frequent washing. Do not wash delicate glassware or glassware containing lead crystal in a dishwasher.

## We recommend

- When purchasing cookware, glassware and cutlery, make sure they are dishwasher-safe.
- Wash particularly delicate glassware by hand.

## Please note

**Silverware** previously cleaned with a **silver polish** may still be damp or spotted at the end of a program, where water has not run off smoothly. Dry with a soft cloth.

Silver treated in a **silver immersion dip** is usually dry at the end of a program but may tarnish.

Silver which has been in contact with foods containing sulphur may discolor. These include egg yolk, onions, mayonnaise, mustard, fish and marinades.

 Aluminum components (e.g. grease filters) must not be cleaned with caustic alkaline commercial or industrial cleaning agents. These may damage the material or, in extreme cases, cause a severe chemical reaction.

# Use

## Upper basket

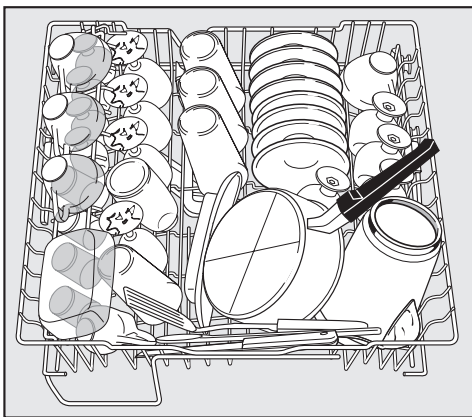

Small, lightweight, delicate items such as cups, saucers, glasses, dessert bowls, etc. , should be placed in the upper basket.

Shallow pans or casserole dishes can also be placed in the upper basket.

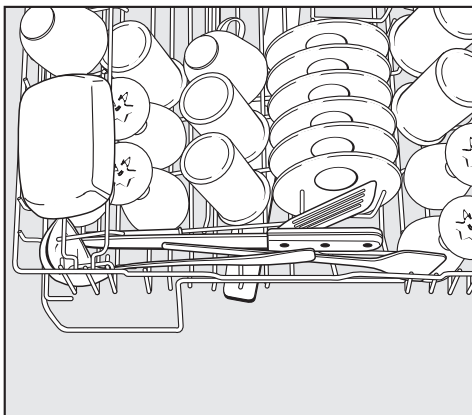

Long items such as soup ladles, mixing spoons and long knives should be placed lying down across the front of the upper basket.

## Hinged cup rack

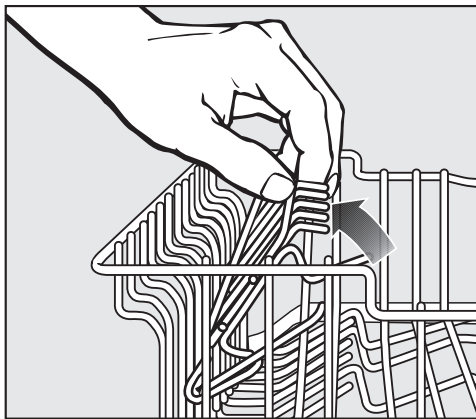

To make room for tall items, raise the rack upwards.

## Adjusting the upper basket

In order to gain more space for taller pieces of cookware in the bottom or upper basket, the upper basket can be adjusted to three levels with 2 cm between each level.

The upper basket can also be set at an angle with one side high and the other side low. Make sure that the basket can be inserted smoothly into the cabinet. Adjust the basket before loading it.

Depending on the setting of the upper basket, the following plate dimensions can be accommodated.

Upper basket level	Plate Ø in cm	
	Upper basket	Lower basket
Top	21.5	30
Middle	23.5	28
Bottom	25.5	26

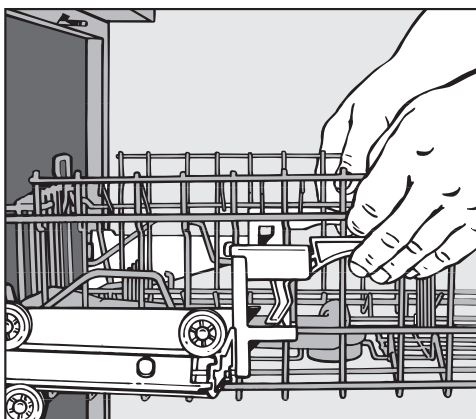

- Pull out the upper basket.
- Pull upwards on the levers at either side of the upper basket.
- Adjust the basket to the desired height.
- Then push the levers securely back down into position.

# Use

## Lower basket

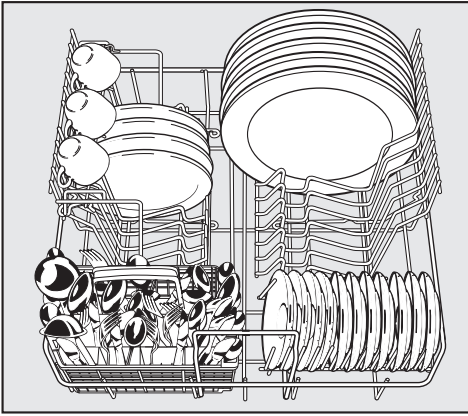

For larger and heavier items such as plates, serving platters, saucepans, bowls, etc. Glasses and small items such as saucers can also be placed in the lower basket. Do not place thin, delicate glassware in the lower basket.

## Hinged cup rack

To make room for tall items, raise the rack upwards.

## Height limitation

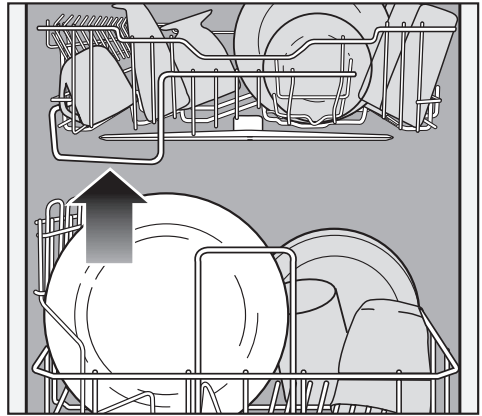

The guide at the front of the upper basket shows the maximum height for items placed in the lower basket so that the middle spray arm is not blocked.



## Lower basket inserts

Various removable inserts are available for the lower basket to accommodate your special needs.

### Removing an insert

- To remove an insert, gently pull upwards on the handle.

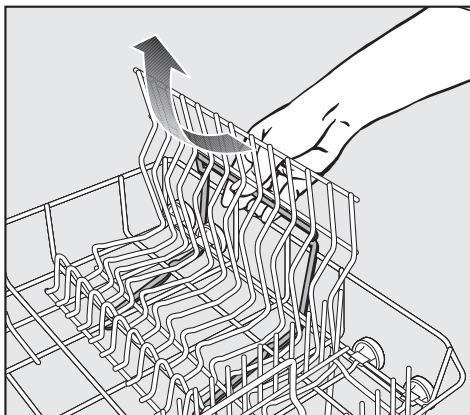

### Inserting an insert

- Slid the hitches of the inset under the vertical struts of the lower basket.
- Push down on the handle to snap the insert into position.

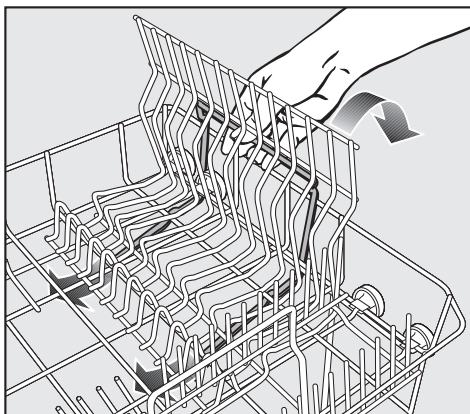

# Use

---

## Adding detergent

 Only use detergents formulated for commercial dishwashers. Do not use dish soap.

Do not use tablet detergent, the short program durations will not allow the tablets to dissolve properly.

Powder detergent is distributed through a dispenser in the door or liquid detergent via the DOS-Module G 60 Semi (available as an optional extra - see "Programming special functions - Dispensing system settings").

## Dosage

- Use at least 30 ml of detergent for a full load in the following programs (G 8050 / PG 8050i):
  - Mini / Express,
  - Midi / Economy,
  - Maxi / Normal,
  - Beer Glasses / Beer Glasses,
  - Glasses / China & Crystal.
- See the "Program Guide" for recommended dispensing amounts.

Follow the detergent manufacturer's instructions if they differ.

Failure to dispense the recommended amount of detergent may impair cleaning results.

 Avoid inhalation of powder detergents and do not ingest dishwasher detergent. Dishwasher detergents contain irritants and/or corrosive ingredients. They can cause burning in the nose, mouth and throat if swallowed or inhibit breathing. Consult a doctor immediately if detergent has been swallowed or inhaled.

Keep detergent and other cleaning agents out of the reach of children at all times. Keep children away from the dishwasher when the door is open. There could still be detergent residues in the cabinet.

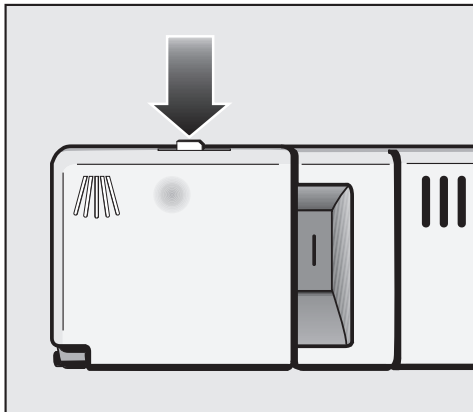

- Press the button of the detergent dispenser. The flap will spring open. The flap is always open at the end of a program.

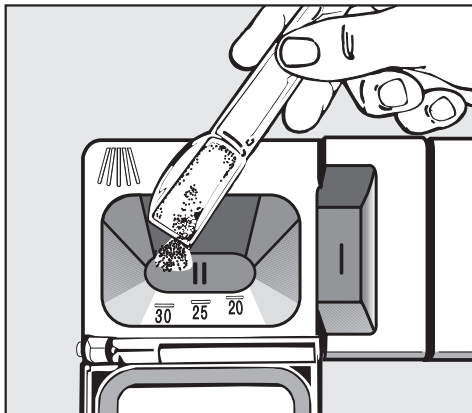

The horizontal marks in Compartment II indicate levels of approximately 20, 25 and 30 ml respectively.

- With the dishwasher door fully open, fill compartment II with 30 ml of powder detergent.
- Close the cover. The cover will always open at the end of a wash program except in "Pre-wash".

# Use

## G 8050

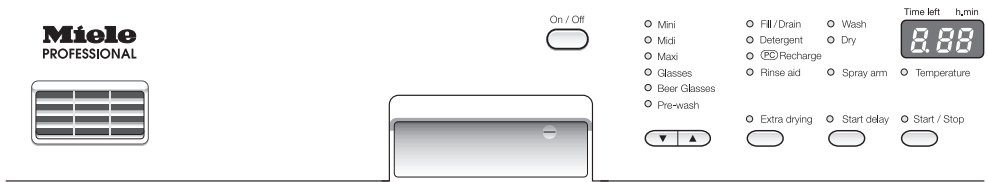

## PG 8050i

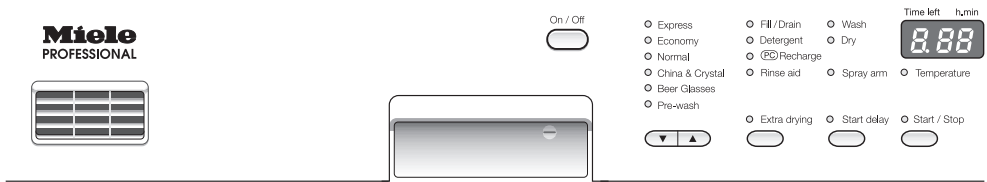



## Turning on

- Make sure the spray arms are not blocked.
- Close the door.
- Open the water supply, if closed.
- Press the "On/Off" button.

The "Start/Stop" indicator will flash and the indicator next to the last program selected will come on.

## Selecting a program

- Choose your program according to the type of load and the degree of soiling.
- See the "Program Guide" for info on the programs.
- Use the program selection buttons   to select the desired program.

 = to scroll down through the programs.

 = to scroll up through the programs.

The indicator next to the selected program will come on.

The duration of the selected program will appear in the display in hours and minutes.

## Selecting options

- If desired, select the "Start delay" or "Extra drying" options (see "Options").

## Starting a program

- Press the "Start/Stop" button.

The program will start. The "Start/Stop" indicator and the indicator next to the last program selected will come on. The sequence indicator for the current program stage reached will also come on.

Do not finish a program prematurely. Important program stages (e.g. reactivating the water softener) could be omitted.

## Program sequence indicators

After a program has been started, the current stage of the program is indicated by the program sequence indicators.

The indicator for the **active** program stage lights up during the program.

"Wash": Main wash / Rinses

"Extra drying": Drying (Options)

## Display

The duration of the selected program appears in hours and minutes in the display before the program begins. During the program the time left until the end of the program is displayed.

The time displayed may vary with the same program. This is due to the water inlet temperature at each intake.

When a program is selected for the first time, the display shows an average time for a cold water intake.

Each time a program is run, the electronic takes the water temperature and the size of the load into account and calculates the required time. This new duration is displayed when this program is selected the next time.

# Use

---

## At the end of a program

☐ appears in the display when the program has finished.

- Open the door and unload the dishwasher.

Dishes tend to break and chip more easily when they are hot. Allow the dishes to cool before unloading them.

If you open the door fully after the program turns off, the dishes will cool much faster.

- Press the "On/Off" button to turn the dishwasher off.

The "Start/Stop" indicator will go out.

The dishwasher continues to use electricity until turned off using the "On/Off" button.

- If the dishwasher will not be used for a longer period of time, e.g. while vacationing, close the water supply.

### **Drying fan running time:**

During the drying phase, as long as the door of the dishwasher remains closed, moist air is expelled through the ventilation outlet of the drying fan. To prevent steam damage to the countertop above the dishwasher, you can select the "Extra drying" option before starting the program. The drying fan will then run at the end of the program until the door is opened (up to a maximum of 45 minutes after the program has finished).

## Interrupting a program

A program is interrupted as soon as the door is opened.

If the door is closed again, the program will continue from the point it was at before the door was opened.

 Water in the dishwasher may be hot. Danger of scalding!  
Only open the door if absolutely necessary and exercise extreme caution when doing so. Before closing the door again, leave it ajar for approx. 20 seconds. This will enable the temperature in the wash cabinet to settle. Then close the door firmly making sure that it clicks into place.

## Changing a program

Important:

If the detergent dispenser flap has already opened, do not change the program.

### If a program has already started

- Press the "Start/Stop" button for at least one second.

The program will be canceled and the "Start/Stop" indicator will flash.

- Use the program selection buttons  to select a different program.

The indicator next to the program selected will come on.

- Select the "Extra drying" and "Start delay" options again if desired (see "Options").
- Press the "Start/Stop" button.

The program will begin.

# Program Guide G 8050

Program	Use	Powder detergent (when not using a liquid cleaning agent) <b>Follow manufacturers instructions</b>
<b>Mini</b>	For normally soiled loads.	30 g in the powder dispenser
<b>Midi</b>	For normally soiled items with a higher wash temperature for removing <b>starchy</b> foods.	30 g in the powder dispenser
<b>Maxi</b>	For heavily soiled items. Most of the soiling is removed in an intensive cold-water pre-rinse.	30 g in the powder dispenser
<b>Glasses</b>	Special program for glasses.	30 g in the powder dispenser
<b>Beer Glasses</b>	Special program for beer glasses.	30 g in the powder dispenser
<b>Pre-wash</b>	To rinse heavily soiled items, (e.g. for removing soiling or to prevent soiling from drying onto dishes when a complete program is not yet needed).	



## Program Guide G 8050

Program	Program sequence						
	Pre-rinse	Pre-wash	Main wash	Interim rinse I	Interim rinse II <sup>1)</sup>	Final rinse	Drying (Option)
Mini	X		X 60 °C 4 min.	X	(X)	X 85 °C <sup>2)</sup> 0.5 min.	(X)
Midi	X		X 65 °C 10 min.	X	(X)	X 85 °C <sup>2)</sup> 1.5 min.	(X)
Maxi	X	X	X 65 °C 10 min.	X	(X)	X 85 °C <sup>2)</sup> 1.5 min.	(X)
Glasses	X		X 65 °C 1 min.	X	(X)	X 85 °C 1 min.	(X)
Beer Glasses	X		X 60 °C 1 min.	X	(X)	X 85 °C <sup>3)</sup> 1,25 min.	(X)
Pre-wash		X Cold 12 min.					

X = Sections included in a program (with temperature/temperature holding time)

- 1) If a second interim rinse is required, this must be programmed by a Miele service technician.
- 2) To alter the rinse aid temperature, see "Programming special functions".  
The drying fan turns on to dissipate the steam.
- 3) Without rinse aid

## Program Guide PG 8050i

Program	Use	Powder detergent (when not using a liquid cleaning agent) <b>Follow manufacturers instructions</b>
<b>Express</b>	A quick wash program for cleaning lightly soiled items.	30 g in the powder dispenser
<b>Economy</b>	For washing lightly soiled dishes with light fatty residues.	30 g in the powder dispenser
<b>Normal</b>	For washing normally and heavily soiled dishes with fatty residues. Program for completely washing a full load of normally soiled dishes with the ability to adjust energy and water consumption based on the soil load of the dishes.	30 g in the powder dispenser
<b>China &amp; Crystal</b>	Special program for China & Crystal.	30 g in the powder dispenser
<b>Beer Glasses</b>	Special program for beer glasses.	30 g in the powder dispenser
<b>Pre-wash</b>	To rinse heavily soiled items, (e.g. for removing soiling or to prevent soiling from drying onto dishes when a complete program is not yet needed).	

## Program Guide PG 8050i

Program	Program sequence						
	Pre-rinse	Pre-wash	Main wash	Interim rinse I	Interim rinse II <sup>1)</sup>	Final rinse	Drying (Option)
Express	X		X 60 °C 4 min.	X	(X)	X 85 °C <sup>2)</sup> 0.5 min.	(X)
Economy	X		X 65 °C 10 min.	X	(X)	X 85 °C <sup>2)</sup> 1.5 min.	(X)
Normal	X	X	X 55 °C 30 min.	X	(X)	X 60 °C 1.5 min.	(X)
China & Crystal	X		X 50 °C 1 min.	X	(X)	X 50 °C 1 min.	(X)
Beer Glasses	X		X 50 °C 1 min.	X	(X)	X Cold <sup>3)</sup> 1,25 min.	(X)
Pre-wash		X Cold 12 min.					

X = Sections included in a program (with temperature/temperature holding time)

- 1) If a second interim rinse is required, this must be programmed by a Miele service technician.
- 2) To alter the rinse aid temperature, see "Programming special functions".  
The drying fan turns on to dissipate the steam.
- 3) Without rinse aid

# Options

---



## Start delay

A start delay time between 30 minutes and 24 hours can be selected.

With a start delay time between 30 minutes and 9 hours 30 minutes, the delay is set in 30 minute increments. For 10 hours or more it is set in one hour increments.

- Turn the dishwasher on with the "On/Off" button.

The "Start/Stop" indicator will flash.

- Use the program selection buttons / to select the desired program.

- Press the "Start delay" button.

The start delay time which was set the last time the function was used will appear in the display in hours and minutes. The "Start delay" indicator will come on.

- Press and hold the "Start delay" button until the desired start delay time shows in the display.
- To turn the function off, press the "Start delay" button again when a delay period of **24h** is shown in the display .  
The duration of the selected program will appear in the display.
- If desired, select the "Extra drying" option.

- Press the "Start/Stop" button.

The "Start/Stop" light will come on.

The time starts counting down until the program start time: in 1 hour increments for start delay periods of over 10 hours and in minutes for start delay periods of under 10 hours.

At the end of the delay period, the selected program starts automatically. The program running time shows in the display, the "Start delay" indicator goes out.

## How the start delay time is displayed

up to 59 minutes:

e.g. 30 minutes = **30**

between 1 hour and 9 hours 30 minutes:

e.g. 5 hours = **5.00**

10 hours and over:

e.g. 15 hours = **15h**

 To prevent children from coming into contact with dishwasher detergent do not fill the detergent dispenser **until just before starting the program**, i.e. before pressing the "Start" button and activating the child safety lock.

When using the "Start delay" option, make sure that the compartment is dry before adding detergent. Wipe dry with a cloth if necessary.

### Starting a program before the Start delay period has elapsed

- Press the "Start/Stop" button for at least one second.

The "Start delay" indicator will go out.

#### **Note:**

If the "Extra drying" option had been selected, it must be selected again.

- Press the "Start/Stop" button.

The program will begin. The "Start/Stop" and "Wash" indicators will come on.

### Extra Drying

The "Extra drying" option can be selected immediately after selecting the program.

**Note:** This option cannot be selected with the "Pre-wash" program. The drying process is carried out by the built-in turbothermic fan and depends on the program. The "Extra Drying" is an additional heating time which turns on for 11 - 17 minutes. The total program duration will increase accordingly.

- Select the desired program.
- Press the "Extra drying" button.
- Press the "Start/Stop" button.

# Programming special functions

---

## Dispensing system settings for DOS Module G 60 Semi (optional extras)

It is not possible to change settings while a program is running. You will have to cancel the program. The "Start/Stop" indicator must be flashing.

### To access the DOS programming level

- Turn the dishwasher off with the "On/Off" button.
- **Press and hold** the "Extra drying" and "Start/Stop" buttons, at the same time, turn the dishwasher on with the "On/Off" button.
- Release the buttons.

The "Wash" indicator will come on and the "Recharge" indicator will flash.

If they do not come on, restart the procedure.

The set water hardness will appear in the display.

- Press the "Extra drying" button once.

The set dispensing time will appear in the display, e.g. **10** (factory setting).

The "Dry" indicator will come on and the "Recharge" indicator will flash.

The programming level for the DOS module has been accessed.

# Programming special functions

## Setting the dosage

Set the dosage according to the detergent manufacturer's recommendations.



The machine needs 5.4 liters of water for the main wash stage of the program.

### Example:

A detergent manufacturer recommends 4 ml of cleaning agent per liter of water:  
 $5.4 \text{ l} \times 4 \text{ ml/l} = 21.6 \text{ ml}$ .

2 ml of cleaning agent will take about 1 second to dispense;

i.e. program to 11 seconds.

- Use the program selection buttons   to select the value that corresponds with the desired dispensing time.

 = button to select a lower value.

 = button to increase the value.

The selected value is displayed.

## Saving the settings

- Press the "Start/Stop" button twice.

The indicator beside the "Start/Stop" button will flash.

The programmed dispensing time is stored in memory.

- Turn the dishwasher off with the "On/Off" button.

Value set: \_\_\_\_\_

## Venting the dispensing system

- Access the DOS programming level.

- Press the "Start delay" button once.

"do1" will appear in the display.

- Press the "Start delay" button again.

The venting process will be carried out.

The remaining time will appear in the display.

At the end of the time  $\bar{0}$  will appear in the display. The dispensing system has now been vented.

- Turn the machine off with the "On/Off" button.

## Immediately after venting

- Start the "Pre-wash" program so that any agents in the wash cabinet are diluted and drained away.

# Programming special functions

---

## Special function 1 Setting the rinse temperature

If you alter the rinse temperature, make a note of the new temperature in the appropriate column of the "Program Guide".

The **rinse temperature** factory setting is listed in the "Program Guide". Use Special function 1 to change the rinse temperature from 85 °C to 65 °C.

At a temperature of 85 °C, the drying fan will turn on when the temperature reaches 65 °C to dissipate the steam.

The drying fan will continue to run for 45 minutes after the program has finished.

The rinse temperature cannot be altered in the programs "Glasses" (G 8050) / "China & Crystal" (PG 8050i) and "Beer Glasses".

It is not possible to change settings while a program is running. You will have to cancel the program. The "Start/Stop" indicator must be flashing.

## Accessing the rinse temperature programming level

- Turn the dishwasher off with the "On/Off" button.
- **Press and hold** the "Extra drying" and "Start/Stop" buttons, at the same time, turn the dishwasher on with the "On/Off" button.

The "Wash" indicator will come on and the "Recharge" indicator will flash.

The set water hardness will then appear in the display.

- Press the "Extra drying" button twice.

The programming level is accessed.

The "Spray arm" indicator will come on, the "Mini" (G 8050) / the "Express" (PG 8050i) indicator will come on or will flash and the "Recharge" indicator will flash.

Special function 1 "Setting the rinse temperature" is selected and indicated with two-digit numbers in the display.



# Programming special functions



---

## Setting the rinse temperature

The first figure is the number of the Special function. The second figure shows which temperature is set.

**10** Rinse temperature 65 °C  
The "Mini" (G 8050) /  
the "Express" (PG 8050i)  
indicator flashes.

**11** Rinse temperature 85 °C  
The "Mini" (G 8050) /  
the "Express" (PG 8050i)  
indicator lights.

- Use the "Extra drying" button to change the setting.
- Use the   program selection buttons to select Special function 1 to 5 (**10** or **11** to **50** or **51** in the display).

## Saving the settings

- Press the "Start/Stop" button twice.

The indicator beside the button will flash.

The programmed setting is now stored in memory.

- Turn the dishwasher off with the "On/Off" button.

Value set: _____
------------------

# Programming special functions

---

## Special function 2 Increasing the water level

It is not possible to change settings while a program is running. You will have to cancel the program. The "Start/Stop" indicator must be flashing.

The amount of water taken into the machine at each intake can be increased by 20 %.

### Accessing the programming level

- Turn the dishwasher off with the "On/Off" button.
- **Press and hold** the "Extra drying" and "Start/Stop" buttons, at the same time, turn the dishwasher on with the "On/Off" button.
- Release these buttons.

The "Wash" indicator will come on and the "Recharge" indicator will flash.

If they do not come on, restart the procedure.

The set water hardness will then appear in the display.

- Press the "Extra drying" button twice.

Special function 1 "Rinse temperature increased" is displayed in double digits (*10* or *11*).

- Press the  button until *20* or *21* appears in the display.

The programming level is accessed.

The "Spray arm" indicator comes on, the "Midi" (G 8050) / the "Economy" (PG 8050i) program indicator will come on or flash and the "Recharge" indicator will flash.

Special function 2 "Increasing the water level" is selected and indicated with two-digit numbers in the display.

# Programming special functions



---

## Setting the water level

The first figure is the number of the Special function. The second figure shows whether or not the function is activated.

**20** Water level increased OFF.  
The "Midi" (G 8050) /  
the "Economy" (PG 8050i)  
indicator flashes.

**21** Water level increased ON.  
The "Midi" (G 8050) /  
the "Economy" (PG 8050i)  
indicator lights  
(20% more water will be  
taken into the machine at each  
water intake).

- Use the "Extra drying" button to turn the increased water level function on or off.
- Use the   program selection buttons to select Special function 1 to 5 (**10** or **11** to **50** or **51** in the display).

## Saving the settings

- Press the "Start/Stop" button twice.

The indicator beside the "Start/Stop" button will flash.

The programmed setting is now stored in memory.

- Turn the dishwasher off with the "On/Off" button.

Value set: _____
------------------

# Programming special functions

---

## Special function 3 Display time or temperature

It is not possible to change settings while a program is running. You will have to cancel the program. The "Start/Stop" indicator must be flashing.

The display can either show the time or temperature.  
Factory default setting is the time.

### Accessing the programming level

- Turn the dishwasher off with the "On/Off" button.
- **Press and hold** the "Extra drying" and "Start/Stop" buttons, at the same time, turn the dishwasher on with the "On/Off" button.
- Release these buttons.

The "Wash" indicator will come on and the "Recharge" indicator will flash.

If they do not come on, restart the procedure.

The set water hardness will then appear in the display.

- Press the "Extra drying" button twice.

Special function 1 "Rinse temperature increased" is displayed in double digits (*10* or *11*).

- Press the  button until *30* or *31* appears in the display.

The programming level is accessed.

The "Spray arm" indicator will come on, the "Maxi" (G 8050) / the "Normal" (PG 8050i) program indicator will come on or flash and the "Recharge" indicator will flash.

Special function 3 "Display time or temperature" is selected and indicated with two-digit numbers in the display.

# Programming special functions



---

## Setting the display

The first figure is the number of the Special function. The second figure shows which feature is displayed.

*30* Time

*31* Temperature

- Use the "Extra drying" button to display the time or temperature.
- Use the   program selection buttons to select Special function 1 to 5 (*10* or *11* to *50* or *51* in the display).

## Saving the settings

- Press the "Start/Stop" button twice.

The indicator beside the button will flash.

The programmed setting is now stored in memory.

- Turn the dishwasher off with the "On/Off" button.

Value set: _____
------------------

# Programming special functions

---

## Special function 4 Actual temperature display

It is not possible to change settings while a program is running. You will have to cancel the program. The "Start/Stop" indicator must be flashing.

The actual temperature can be displayed constantly or only during the program blocks "Wash" and "Rinse".

## Accessing the programming level

- Turn the dishwasher off with the "On/Off" button.
- **Press and hold** the "Extra drying" and "Start/Stop" buttons, at the same time, turn the dishwasher on with the "On/Off" button.
- Release the buttons.

The "Wash" indicator will come on and the "Recharge" indicator will flash.

If they do not come on, restart the procedure.

The set water hardness will then appear in the display.

- Press the "Extra drying" button twice.

Special function 1 "Rinse aid temperature increased" is displayed in double digits (*10* or *11*).

- Press the  button until *40* or *41* appears in the display.

The "Spray arm" indicator will come on, the "Glasses" (G 8050) / the "China & Crystal" (PG 8050i) program indicator will come on or flash, the "Recharge" indicator will flash.



Special function 4 "Actual temperature display" is selected and indicated with two-digit numbers in the display.

# Programming special functions

---

## Setting the temperature display

The first figure is the number of the Special function. The second figure shows whether or not the function is activated.

- 40 Actual temperature is displayed constantly
- 41 Actual temperature is only displayed during heating phases (during program sequences without heating bars will appear in the display)
- Use the "Extra drying" button to set the actual temperature display.
- Use the   program selection buttons to select Special function 1 to 5 (10 or 11 to 50 or 51 in the display).

## Saving the settings

- Press the "Start/Stop" button twice.

The indicator beside the button will flash.

The programmed setting is now stored in memory.

- Turn the dishwasher off with the "On/Off" button.

Value set: \_\_\_\_\_

# Programming special functions

---

## Special function 5 Setting the heating power

It is not possible to change settings while a program is running. You will have to cancel the program. The "Start/Stop" indicator must be flashing.

The heating power can only be altered when the rinse temperature is set to 85°C, see "Special function 1".

The heating power is factory set to 1.3 kW.

If the dishwasher is set to a higher heating power (see "Electrical connection"), the heating power must be adjusted in this special function.

## Accessing the programming level

- Turn the dishwasher off with the "On/Off" button.
- **Press and hold** the "Extra drying" and "Start/Stop" buttons, at the same time, turn the dishwasher on with the "On/Off" button.

The "Wash" indicator will come on and the "Recharge" indicator will flash.

If they do not come on, restart the procedure.

The set water hardness will then appear in the display.

- Press the "Extra drying" button twice.

Special function 1 "Rinse aid temperature increased" is displayed in double digits (*10* or *11*).

- Press the  button until *50* or *51* appears in the display.

The "Spray arm" indicator will come on, the "Beer Glasses" program indicator will come on or flash and the "Recharge" indicator will flash.

Special function 5 "Setting the heating power" is selected and indicated with two-digit numbers in the display.



# Programming special functions



---

## Setting the heating power

The first figure is the number of the Special function. The second figure shows the setting.

*50* Heating power 1.3 kW

*51* Heating power over 1.3 kW

- Use the "Extra drying" button to set the heating power.
- Use the   program selection buttons to select Special function 1 to 5 (*10* or *11* to *50* or *51* in the display).

## Saving the settings

- Press the "Start/Stop" button twice.

The indicator beside the button will flash.

The programmed setting is now stored in memory.

- Turn the dishwasher off with the "On/Off" button.

Value set: \_\_\_\_\_

## Cleaning and care

Check your dishwasher regularly (approx. every 4 - 6 months). This way faults and problems can be avoided.

### Cleaning the filters in the wash cabinet

The triple filter in the base of the wash cabinet retains coarse soil from the wash water, preventing it from accessing the circulation system and re-entering the cabinet through the spray arms.

 The dishwasher must not be used without all the filters in place.

Collection of coarse soil may cause the filters to clog.

- Check the triple filter regularly (every week).
- Turn the dishwasher off.

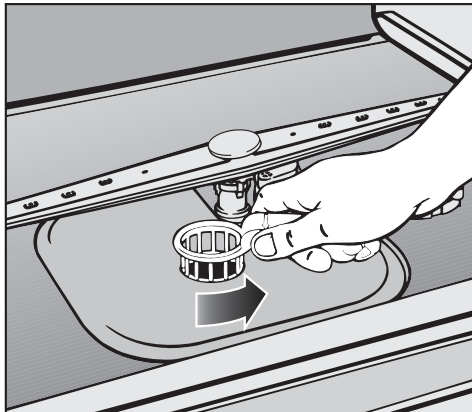

- Turn the handle counterclockwise to release the triple filter.

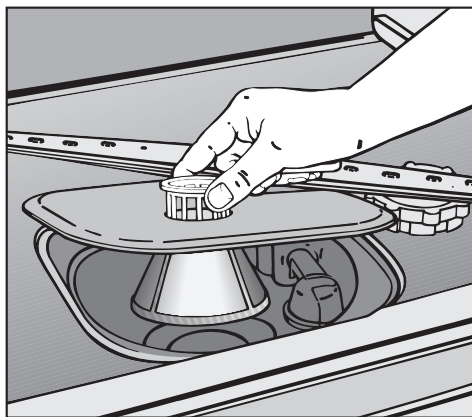

- Lift the triple filter out of the dishwasher.
- Remove any coarse particles and rinse the filter under running water. Use a nylon brush if necessary.

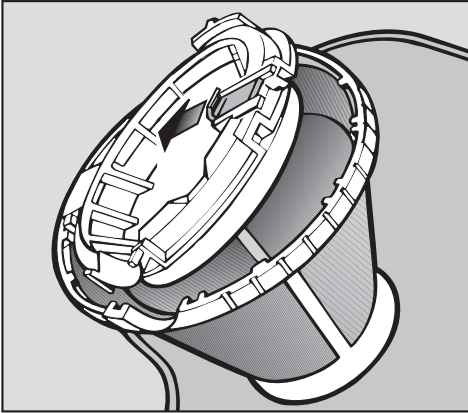

To clean the inside of the filter, the flap must be opened.

- Pull back the yellow clip.
- Rinse all parts under running water, using a nylon brush if necessary.
- Then close the flap so that the catch engages.

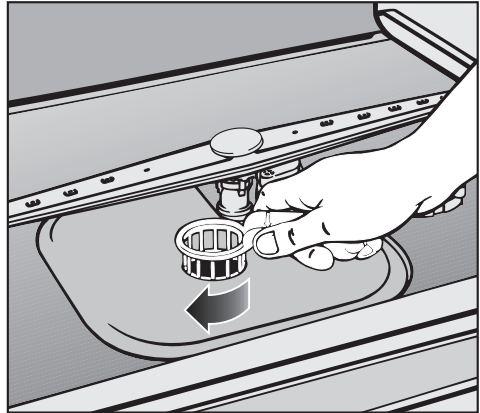

- Replace the triple filter making sure it is correctly secured in position in the base of the wash cabinet.
- Then turn the handle clockwise to lock the triple filter in place.

## Cleaning and care

### Cleaning the spray arms

Sometimes particles get stuck in the spray arm jets.

The spray arms should be inspected and cleaned **every 4 - 6 months**.

- Turn the dishwasher off.
- Push the **top** spray arm upwards to engage the inner ratchet. Then unscrew the spray arm.

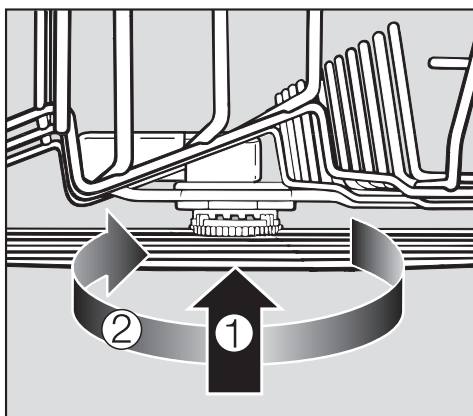

- Push the **middle** spray arms upwards ① to engage the ratchet. Then unscrew the spray arm ②.
- Remove the lower basket.

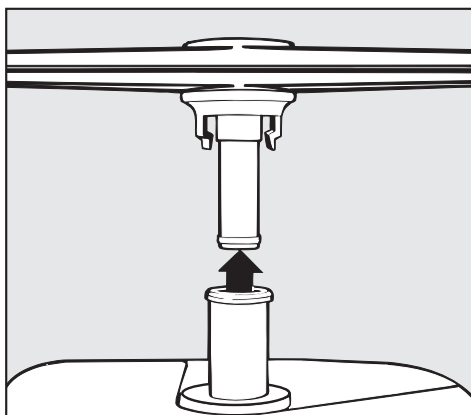

- Pull the **lower** spray arm firmly upwards to remove it.

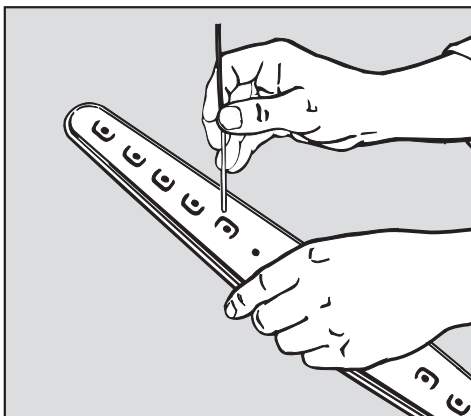

- Use a pointed object to push food particles into the spray arm jets.
- Rinse thoroughly under running water.
- Replace the spray arms and check that they rotate freely.

## Cleaning the wash cabinet

The wash cabinet is self-cleaning, provided that the correct amount of detergent is always used.

If limescale or grease deposits show in the cabinet, they can be removed with a dishwasher cleaner, available from Miele.

## Cleaning the door and the door seal

- Clean the door seals regularly with a damp cloth to remove food deposits.
- When the dishwasher is being loaded, food and drink residue may drip onto the sides of the dishwasher door.  
These surfaces are outside the wash cabinet and are not accessed by water from the spray arms. Any soiling should be wiped off these surfaces before the door is closed.

## Cleaning the control panel and exterior

 Do not use thinners, abrasive-, glass-, all-purpose - or ammonia cleaners.

They **will** damage the surfaces.

### Plastic surfaces

- Clean with a damp cloth or with a cleaner designed for use on plastic.

# Cleaning and care

## Cleaning the water inlet filter

A filter is incorporated in the screw connection of the valve on the water inlet hose. The filter must be cleaned when dirty, otherwise the water flowing into the wash cabinet is insufficient.

 The plastic housing of the water connection contains an electrical component. It must not be submerged in water.

If the mains water contains a large number of insoluble substances, we recommend fitting a large-area filter in the connection between the water faucet and the water inlet hose threaded union.

This filter is available from your Miele dealer or Miele.

### Cleaning the filter

- Disconnect the machine from electricity (unplug it or "trip" the circuit breaker).
- Close the water supply.
- Unscrew the inlet hose.

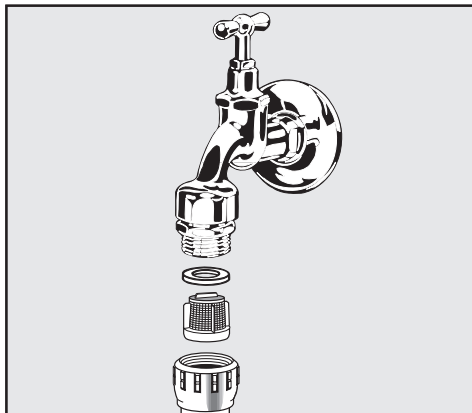

- Carefully remove the seal.
- Remove the filter using needle nose pliers and rinse clean under running water.
- Replace the filter and seal, making sure they are sitting correctly.
- Reconnect the inlet hose to the water supply, making sure it goes on correctly and is not cross-threaded.
- Turn on the water supply gradually to test for leaks.

## Cleaning the drain pump and non-return valve

If the water has not been drained at the end of a program the drain pump or the non-return valve might be blocked.

 Be careful - glass or bone splinters could cause injury.

- Take the triple filter out of the wash cabinet (see "Cleaning and care" - Cleaning the filters in the wash cabinet").
- Scoop the water out of the cabinet using a suitable container or utensil.

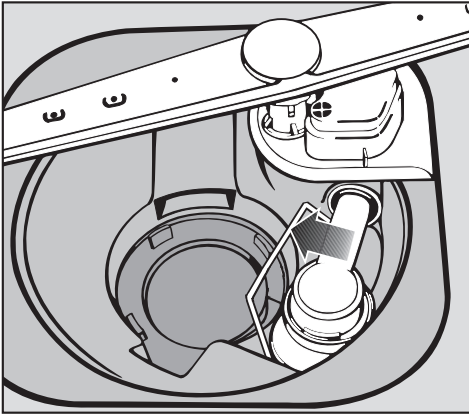

- Raise the locking clamp of the non-return valve.

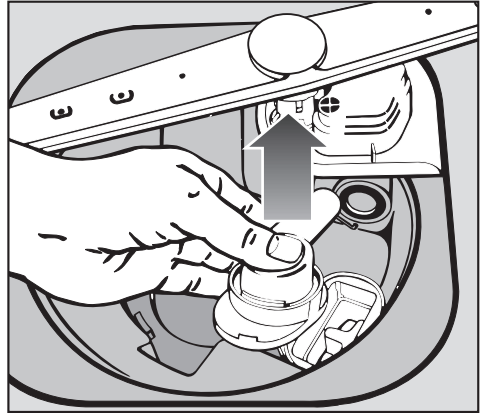

- Lift out the non-return valve and rinse under running water.
- Remove all foreign objects from the non-return valve.

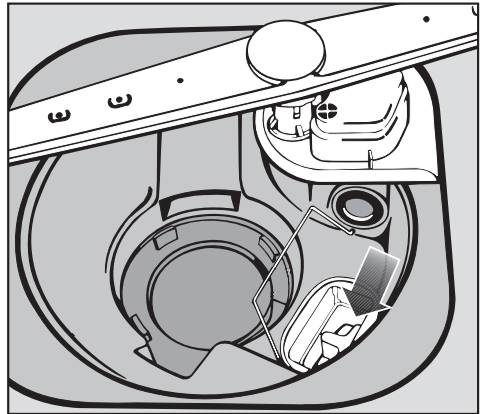

The drain pump is located under the non-return valve (see arrow).

- Clean any foreign objects from the drain pump. Turn the drain pump impeller by hand to check for objects.
- Carefully replace the non-return valve and secure it with the locking clamp.

## Frequently asked questions

With the aid of the following guide, minor problems can be fixed without a service call.

Repairs should only be carried out by a qualified and trained person in accordance with local and national safety regulations. Unauthorized repairs could cause personal injury or machine damage.

<b>Technical faults</b>		
<b>Issue</b>	<b>Possible fault</b>	<b>Solution</b>
<b>The "Start/Stop" indicator does not flash after the appliance has been turned on with the "On/Off" button.</b>	The door is not properly closed.	Close the door firmly.
	The appliance is not plugged in.	Insert the plug.
	The fuse is defective or has tripped.	Replace the fuse (see data plate).
<b>The dishwasher stops during a program.</b>	The fuse is defective or has tripped.	Replace the fuse (see data plate).
<b>The "Fill/Drain" indicator lights and flashes alternately.</b>	The water supply is closed.	Open the water supply fully.
	The water inlet filter is blocked.	Before fixing the problem: <ul style="list-style-type: none"> <li>– Press the "Start/Stop" button for at least one second.</li> <li>– Turn the dishwasher off.</li> </ul> Then: <ul style="list-style-type: none"> <li>– Clean the water inlet filter, see "Cleaning the water inlet filter".</li> </ul>
	The Waterproof system has reacted.	Call the Miele Service Department.



## Frequently asked questions

Issue	Possible fault	Solution
<b>The "Fill/Drain" indicator flashes and the program stops.</b>		Before fixing the problem: <ul style="list-style-type: none"> <li>– Press the "Start/Stop" button for at least one second.</li> <li>– Restart the program.</li> </ul>
	The water supply is closed.	Open the water supply fully.
	The water inlet filter is blocked.	Before fixing the problem: <ul style="list-style-type: none"> <li>– Press the "Start/Stop" button for at least one second.</li> <li>– Turn the dishwasher off.</li> </ul> Then: <ul style="list-style-type: none"> <li>– Clean the water inlet filter, see "Cleaning the water inlet filter".</li> </ul>
	The water pressure at the intake is lower than 0.3 bar (4 psi).	Contact a plumber.
		Before fixing the problem: <ul style="list-style-type: none"> <li>– Press the "Start/Stop" button for at least one second.</li> <li>– Turn the dishwasher off.</li> </ul>
	The triple filter in the wash cabinet is clogged.	Clean the triple filter, see "Cleaning and Care".
	The drain pump or non-return valve may be blocked.	Clean the drain pump and non-return valve, see "Cleaning the drain pump and non-return valve".
	The drain hose is kinked.	Remove any kinks in the drain hose.

## Frequently asked questions

Issue	Possible fault	Solution
<p><b>Three horizontal bars show in the display at the end of the program: - - -</b></p>	<p>There may be a technical fault.</p>	<ul style="list-style-type: none"> <li>– Press the "Start/Stop" button for at least one second.</li> <li>– Turn the dishwasher off.</li> </ul> <p>After a few seconds:</p> <ul style="list-style-type: none"> <li>– Turn the dishwasher on.</li> <li>– Select the desired program.</li> <li>– Press the "Start/Stop" button.</li> </ul> <p>If the three horizontal bars appear again at the end of the program, there is a technical fault.</p> <ul style="list-style-type: none"> <li>– Contact the Miele Service Department.</li> </ul>
<p><b>Knocking noise in the wash cabinet</b></p>	<p>The spray arm is hitting an item in the basket.</p>	<p>Interrupt the program, rearrange items blocking the spray arms.</p>
<p><b>Rattling noise</b></p>	<p>Items are not secure in the wash cabinet.</p>	<p>Interrupt the program and rearrange loose pieces.</p>
<p><b>Knocking noise in the water pipes</b></p>	<p>This may be caused by the installation or diameter of the pipe.</p>	<p>This has no effect on the dishwasher. If in doubt contact a plumber.</p>

## Frequently asked questions

<b>Poor cleaning results</b>		
<b>Issue</b>	<b>Possible fault</b>	<b>Solution</b>
<b>The dishes are not clean.</b>	The dishes were not loaded correctly.	Load items so water can reach all surfaces. See "Use - Loading the machine" for more information.
	The outlet of the water intake pipe for the middle spray arm was covered. An insufficient amount of water reached the middle spray arm.	Make sure that dishes placed in the rear section of the upper basket do not cover the opening.
	The program was not powerful enough.	Select a more powerful program, see the "Program Guide".
	Not enough detergent was dispensed.	Use more detergent, see "Use - Adding detergent".
	Tall items are blocking the path of the spray arms.	Rearrange the items so that the spray arms can rotate freely.
	The spray arm jets are blocked.	Clean the spray arm jets, see "Cleaning and Care".
	The triple filter in the base of the wash cabinet is not clean or is not correctly fitted. This may cause the spray arm jets to get blocked.	Clean and/or replace the triple filter correctly. Clean the spray arm jets, see "Cleaning and Care".
	The non-return valve is open and blocked. Soiled water got back into the wash cabinet.	Clean the drain pump and the non-return valve, see "Cleaning the drain pump and non-return valve".

## Frequently asked questions

Issue	Possible fault	Solution
<b>Dishes are not dry, glasses and cutlery are spotted</b>	The rinse aid setting may be too low or the rinse aid reservoir is empty.	Increase the dosage or refill the reservoir, see "Rinse aid".
	Items were taken out of the dishwasher too soon.	Leave them in longer, see "Use".
<b>White residue is visible on cutlery and dishes, clouding occurs on glassware and film can be wiped off</b>	Not enough rinse aid was used.	Increase the dosage, see "Rinse aid".
	The salt reservoir is empty.	Replenish reactivation salt, see "Water softener".
	The salt reservoir cap was not properly screwed on.	Reseat and screw the cap on firmly.
<b>Smears on glasses and cutlery, bluish sheen on the surface of glasses and film can be wiped off</b>	The rinse aid dosage is set too high.	Use less rinse aid, see "Rinse aid".
<b>Glasses are dull and discolored and film cannot be wiped off</b>	Glasses were not dishwasher safe.	There is no remedy. Only wash dishwasher safe glasses.
<b>Tea or lipstick stains have not been completely removed</b>	The wash temperature of the selected program was too low.	Select a program with a higher wash temperature.
	The detergent has a low bleaching effect.	Use a different detergent brand.
<b>Plastics are discolored</b>	Natural dyes e.g. from vegetables may be the cause. Not enough detergent was used to break down natural dyes.	Use more detergent, see "Use - Adding detergent". Discoloration is permanent.
<b>Rust stains on cutlery</b>	The salt reservoir cap was not properly screwed on.	Reseat and screw the cap on firmly.
	The affected items are not rust resistant.	There is no remedy. Only wash dishwasher safe cutlery.
	The "Pre-wash" program was not run after adding reactivation salt. Traces of salt got into the wash cycle.	Always run the "Pre-wash" program after adding reactivation salt.

## Frequently asked questions

<b>Other faults</b>		
<b>Issue</b>	<b>Possible fault</b>	<b>Solution</b>
<b>Detergent residue is left in the dispenser at the end of a program.</b>	The dispenser was still damp when detergent was added.	Make sure the dispenser is dry before adding detergent.
<b>The detergent lid cannot be closed properly.</b>	Clogged detergent residue is blocking the catch.	Remove the residue.
<b>Water remains in the wash cabinet at the end of a program.</b>		Before fixing the problem: <ul style="list-style-type: none"> <li>– Press the "Start/Stop" button.</li> <li>– Turn the dishwasher off.</li> </ul>
	The triple filter in the wash cabinet is clogged.	Clean the triple filter, see "Cleaning and Care".
	The drain pump or non-return valve may be blocked.	Clean the drain pump and the non-return valve, see "Cleaning the drain pump and non-return valve".
	The drain hose is kinked.	Remove any kinks in the drain hose.

## After sales service

---

In the event of any faults that you cannot fix yourself, please contact the Miele Service Department. See back cover for contact details.

- When contacting your Dealer or the Miele Service Department, please quote the model type and number of your machine, both of which are shown on the data plate at the top of the door.

### Program update function - PC

The program update function (PC) is designed to enable a service technician to update your machine's electronics in keeping with advances in technology.

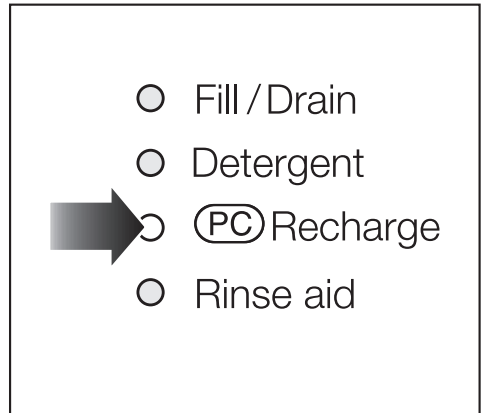

The "PC" indicator is used as the interface for this programming.



## Installation Instructions

To prevent accidents  
and machine damage  
read these instructions  
**before**  
installation or use.

# Installation

---

## Installation options

- **Free-standing**
- **Undercounter**

The machine can be installed under a continuous counter or sink drain. The recess must be at least 60 cm wide, 60 cm deep and 82 cm high.

## Installation

 Furniture and fittings installed near the machine must be of a commercial standard (able to withstand the effects of steam).

- Please refer to the installation diagram supplied with the machine.

## Leveling the machine

- The dishwasher needs to stand even. It can be leveled with the four height adjustable feet.

## Integrated ("i") professional dishwashers:

 To ensure stability, these dishwashers should only be installed under a continuous countertop which must be securely screwed to adjacent units.

"i" models are designed for installation under a continuous countertop.

- The accessories are enclosed in a separate package for on-site installation.
- The front of the dishwasher is designed to take a front panel. It can be fitted with a base unit door front to match the rest of the kitchen.
- The dishwasher does not have a toekick. The toekick area of the dishwasher needs to be covered either with a toekick board to match the kitchen cabinets or with one which can be ordered as a special accessory. The height of the dishwasher toekick can be adjusted to match that of adjacent cabinets. The toekick recess depth is also adjustable.

All instructions necessary for installing the dishwasher are described in separate installation instructions.



## Positioning and securing the machine

To ensure stability for undercounter installations, the machine must be aligned and screwed to the counter.

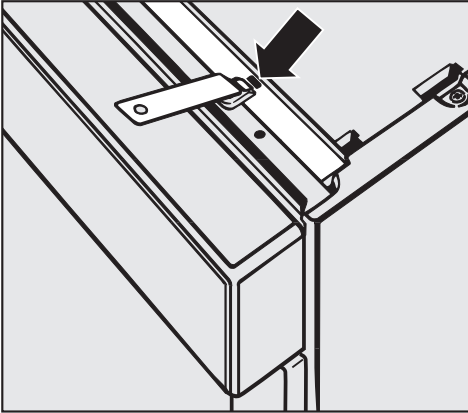

- Insert the brackets in the slots.
- Line up the bracket holes with the long holes in the cover plate. Adjust if necessary making sure the dishwasher is centered to the adjacent cabinetry.
- Push the dishwasher in the recess.
- Open the door.

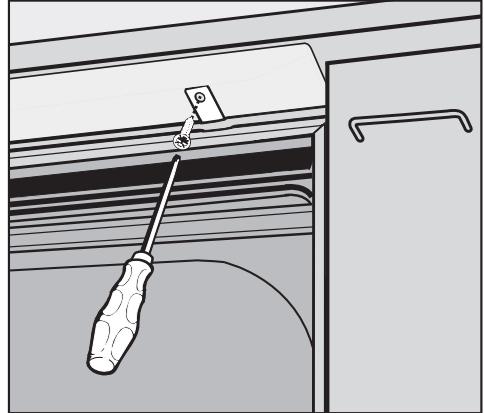

- Secure the machine with the brackets to the front edge of the countertop using the supplied screws.
- Make sure that the seal on the top edge of the dishwasher sits flush against the countertop. Adjust the feet if necessary.

Do not use silicone sealant to seal the gaps between the machine and any neighboring units.

- When not mounted undercounter, floor mounting brackets must be used.

# Installation

## Steam Deflector

Depending on the requirements for an undercounter installation, a steam deflector can be ordered from the Miele Technical Service Department.

The underside of the countertop is protected from steam damage by this stainless steel plate.

## Granite and marble countertops

These countertops require that the dishwasher is securely screwed to neighboring units on the right and left hand sides. Two special fixing brackets are available as an accessory.+

## Removing the lid

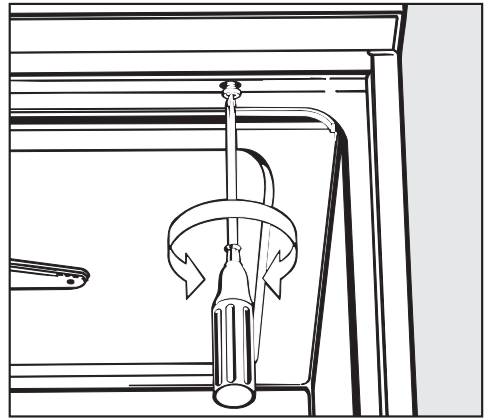

If necessary, remove the lid from the machine to make installation possible.

- Open the door.
- Remove the fixing screws on the left and right sides using a Phillips head screwdriver.
- Pull the machine lid approx. 5 mm forwards, lift it upwards and remove.

## Electrical connection

 All electrical work must be carried out by a suitably qualified person in compliance with local and national safety regulations.

Installation, repairs and other work by unqualified persons could be dangerous. The manufacturer cannot be held responsible for unauthorized work.

 Ensure power is not supplied to the appliance until after installation.

The dishwasher comes equipped with a power cord and plug.

 The power outlet must be accessible after installation. Do not use an extension cord to connect the dishwasher to the mains. Danger of overheating!

A damaged power cord must only be replaced with a genuine Miele cord by a Miele service technician.

The machine must only be operated with the voltage, frequency and fusing shown on the **data plate** located on the rear of the machine, and on the top of the door.

**GROUNDING INSTRUCTIONS** This appliance must be grounded. In the event of malfunction or breakdown, grounding will reduce the risk of electric shock by providing a path of least resistance for electric current. This appliance is equipped with a cord having an equipment-grounding conductor and a grounding plug. The plug must be plugged into an appropriate outlet that is properly installed and grounded in accordance with all local codes and ordinances.

**WARNING** – Improper connection of the equipment-grounding conductor can result in the risk of electric shock. Check with an electrician if in doubt of the appliance's grounding. Do not modify the plug provided with the appliance: if it will not fit the outlet, have a proper outlet installed by a qualified electrician.

The wires in the cord are colored in accordance with the following code:

Green/yellow	= ground
Blue	= neutral
Brown	= live

**WARNING**  
**THIS APPLIANCE MUST BE GROUNDED**

# Electrical connection

The G 8050 / PG 8050i comes equipped with a 14/3 AWG cord and plug for connection to a standard 120 V, 60 Hz AC power outlet.

If available, the dishwasher may be connected to a 208/240V single phase power supply. This will increase the power to the heating elements and shorten the time of selected wash cycle.

	120V	208V	240V
<b>Rated Load (kW)</b>	1.5	3.6	4.0
<b>Fuse Rating</b>	15A	20A	20A

To connect the machine to a 208/240V supply, the standard power cord must be removed and replaced by a 10/4 AWG SJ or SJO cable. A 3 pole, 4-wire grounding plug and receptacle are recommended (NEMA Type 14-20R and 14-20P).

The **conversion diagram** and **wiring diagram** are secured to the inner side of the toe kick.

## Removing the toe kick

Disconnect the machine from the mains electrical supply.

- Remove the fixing screws from the toe kick and take it off.

## Power connection options

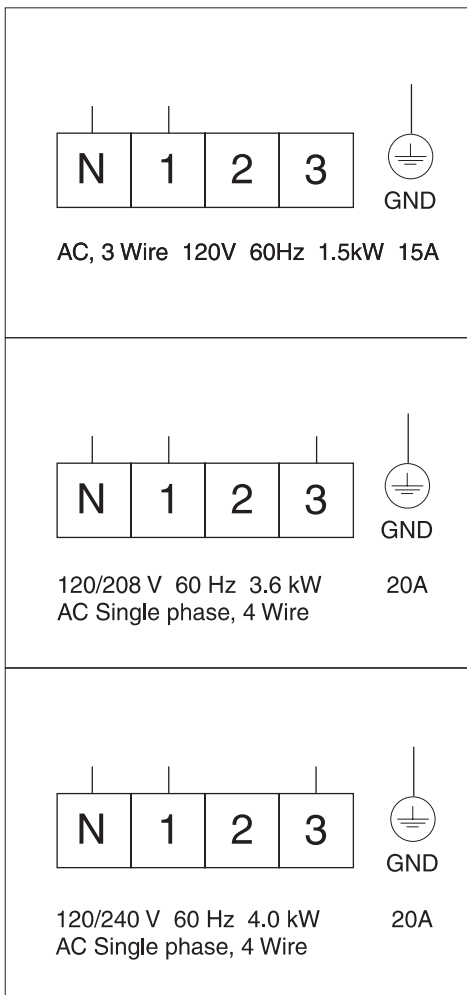



## Water inlet

 Water in the machine must not be used as drinking water.

- The machine must be connected to the water supply in accordance with local and national regulations.
- The water supply must meet or surpass all applicable tap water codes.  
High iron content can lead to rust formation in the appliance and on the items washed.  
If the chloride content in the water supply is above 100mg/l, the risk of corrosion is greatly increased.
- The washer is constructed so it may be connected to a water supply without an extra non-return valve, unless required by code.
- Water in certain regions shows precipitations. In this case the machine must only be used with a water softener unit.
- The water pressure (flow rate) must be a minimum of 7.25 psi.  
If the water pressure (flow rate) is below 29 psi, the filling time is automatically extended.  
The max. permitted static pressure is 145 psi.  
If the water pressure is not in the range of 7.25 to 145 psi the "Fill/Drain" indicator may come on and the fault code "F2E" may show in the display. Please contact the Miele Service Department.

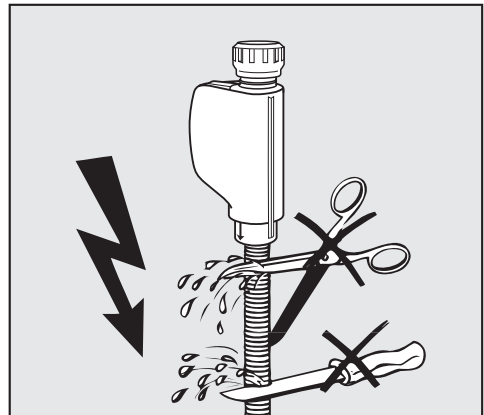
- The machine is supplied to be connected to a standard cold **or** hot water supply at a maximum temperature of 60 °C.
- A water valve with  $\frac{3}{4}$ " male hose thread is to be provided on site. It should be easily accessible so the water supply can be turned off when the machine is not in use.
- The inlet hose is 1.7 m long, with a 2 cm female hose thread. A 1.5 m extension hose is available (flexible metal hose, 2.03 psi pressure). **The water inlet filters in the threads must not be removed.**



 The inlet hose must **not** be shortened or damaged in any way (see illustration).

- See also the installation diagram supplied.

# Plumbing

---

## Drainage

– The drain hose is equipped with a non-return valve which prevents waste water from flowing back into the machine.

– The machine should preferably be connected to a **separate** drainage system onsite.

If separate drainage is not available contact your Miele application specialist for advice.

The onsite drain connection point should be located between 1 ft.

(0.3 m) and 3' 3". (1 m) **above the lower edge of the machine.**

If it is lower than 1 ft. (0.3 m), bend the hose in a curve to a height of at least 1 ft. (0.3 m).

The drainage system must be able to take a minimum drainage flow of 4.5 gal/min (16 l/min).

– The flexible drain hose is 4' 7" (1.4 m) long and has an internal diameter of  $\frac{7}{8}$ " (22 mm). Do not cut the drain hose.

Hose clamps are supplied for securing it into position.

– A longer drain hose (up to 13 ft. [4 m] long) is available from Miele.

– The drainage system must not exceed 13 ft. (4 meters).

– See the supplied installation diagram.

## Technical data

---

Height:	85 (82) cm
Width:	60 cm
Depth:	60 cm
Voltage:	see data plate
Connected load:	see data plate
Fuse rating:	see data plate
Mains connection cable:	approx. 1.8 m
Water pressure (flow rate):	7.25 - 145 psi (50 - 1000 kPa)
Cold or hot water connection:	up to max. 60 °C
Delivery head:	min. 0.3 m, max. 1 m
Drainage length:	max. 4 m
Inlet hose:	approx. 1.7 m
Drain hose:	approx. 1.4 m
Noise level in dB (A): Sound level LpA	Free standing: under 60 Built-in: under 70
Test marks:	Interference suppression
Certification:	CSA
Manufacturer address:	Miele & Cie. KG, Carl-Miele-Str. 29 33332 Gütersloh, Germany

# Help to protect the environment

---

## **Disposal of the packing material**

The protective packing materials are environmentally safe and can be recycled.

Ensure that any plastic wrappings, bags, etc. are disposed of safely and kept out of the reach of children.

Danger of suffocation!

## **Disposal of the appliance**

Appliances contain materials which can be recycled. Please contact your local authorities about recycling in your area.

Ensure that the machine presents no danger to children while being stored for disposal. See "Important Safety Instructions".









# **Miele**

## **PROFESSIONAL**

### **Canada** **Miele Limited**

Professional Division  
161 Four Valley Drive  
Vaughan, ON L4K 4V8  
Phone: 1-888-325-3957  
905-532-2271  
Fax: 1-800-803-3366  
[www.mieleprofessional.ca](http://www.mieleprofessional.ca)  
[professional@miele.ca](mailto:professional@miele.ca)

**MieleCare National Service**  
Phone: 1-888-325-3957  
905-532-2271  
Fax: 905-532-2295  
[serviceprofessional@miele.ca](mailto:serviceprofessional@miele.ca)

**Germany**  
Miele & Cie. KG  
Carl-Miele-Straße 29  
33332 Gütersloh