

# Miele

## Operating instructions

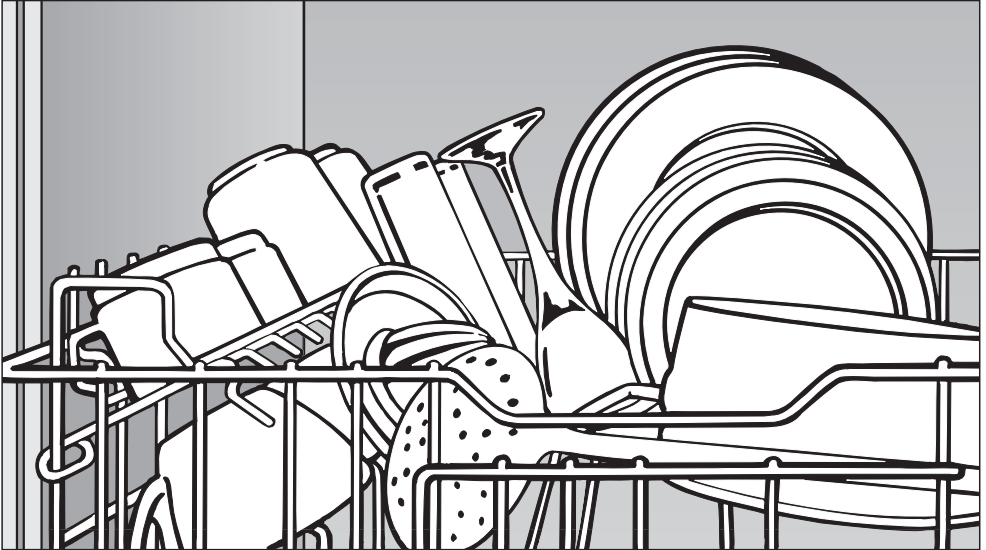

**Incognito**  
**G 643 SCVi**  
**G 843 Vi**  
**G 843 SCVi**

To prevent accidents  
and machine damage,  
read these instructions  
**before**  
installation or use.

**HG01**



M.-Nr. 05 431 291

# Contents

---

<b>IMPORTANT SAFETY INSTRUCTIONS</b> . . . . .	4
<b>CONSIGNES DE SÉCURITÉ</b> . . . . .	7
<b>Caring for the environment</b> . . . . .	10
Energy saving washing . . . . .	10
<b>Guide to the dishwasher</b> . . . . .	11
Wash cabinet . . . . .	11
Control panel . . . . .	12
<b>Before using for the first time</b> . . . . .	13
To open the door . . . . .	13
To close the door . . . . .	13
Water softener . . . . .	14
Programming the water softener . . . . .	15
Checking the programmed water hardness . . . . .	16
Salt indicator . . . . .	18
Rinse aid . . . . .	19
Adding rinse aid . . . . .	19
Adjusting the dosage . . . . .	20
Rinse aid indicator . . . . .	20
<b>Loading the dishwasher</b> . . . . .	21
Items not recommended for dishwashing . . . . .	22
Cutlery basket . . . . .	23
Cutlery tray (SC units) . . . . .	24
Upper basket . . . . .	25
Adjusting the upper basket . . . . .	25
Adjustable cup racks . . . . .	26
Coffee bar . . . . .	26
Lower basket . . . . .	27
Foldable spikes . . . . .	28
Bottle holder (select models) . . . . .	28
<b>Basket accessories</b> . . . . .	29

<b>Operation</b> . . . . .	30
Adding detergent . . . . .	30
Running the dishwasher . . . . .	31
At the end of a program . . . . .	31
Interrupting a program . . . . .	32
Changing a program . . . . .	32
Program guide . . . . .	33
<b>Frequently asked questions</b> . . . . .	34
<b>After sales service</b> . . . . .	40
<b>Transport</b> . . . . .	41
<b>User Maintenance Instructions</b> . . . . .	43
Cleaning the filter in the wash cabinet . . . . .	44
Cleaning the spray arms . . . . .	46
Cleaning the wash cabinet . . . . .	47
Cleaning the door and door seal . . . . .	47
Cleaning the optic indicator reflector . . . . .	47
Cleaning the control panel . . . . .	48
Cleaning the exterior . . . . .	48
Cleaning the water inlet filter . . . . .	49
Cleaning the drain pump and non-return valve . . . . .	50

# IMPORTANT SAFETY INSTRUCTIONS

---

## WARNING –

**When using your dishwasher, follow basic precautions, including the following:**

**Read all instructions before installation or use of the dishwasher to prevent injury and machine damage.**

The manufacturer cannot be held responsible for damage or injury caused by improper use of this appliance.

Use the dishwasher only for its intended purpose. This appliance is intended for residential use only.

Keep these operating instructions in a safe place and pass them on to any future user.

## Electrical safety

Before installation make sure that the voltage and frequency listed on the data plate correspond with the household electrical supply. This data must correspond to prevent injury and machine damage. Consult a qualified electrician if in doubt.

Before installation or service, disconnect the power supply to the work area by unplugging the unit, “tripping” the circuit breaker or removing the fuse.

Do not use an extension cord to connect this appliance to electricity. Extension cords do not guarantee the required safety of the appliance (e.g. danger of overheating).

Be certain your appliance is properly installed and grounded by a qualified technician. To guarantee the electrical safety of this appliance, continuity must exist between the appliance and an effective grounding system. It is imperative that this basic safety requirement be met. If there is any doubt, have the electrical system of the house checked by a qualified electrician. The manufacturer cannot be held responsible for damages caused by the lack, or inadequacy, of an effective grounding system.

## Installation

Installation and repair work should be performed by a Miele authorized service technician. Work by unqualified persons could be dangerous and could void the warranty.

**⚠ WARNING - Fire hazard**  
Do not cover or crush the plug of an electric appliance. Ensure that the cabinet opening for the dishwasher provides ample space for the plug. Installing the dishwasher in a tight space may crimp the power cord or put pressure on the plug which may cause overheating.

# IMPORTANT SAFETY INSTRUCTIONS

---

■ This equipment is not designed for maritime use or for use in mobile installations such as recreational vehicles or aircraft. However, under certain conditions it may be possible for an installation in these applications. Please contact the nearest Miele dealer or the Miele Technical Service Department with specific requirements.

■ Inspect the dishwasher for shipping damage. Do not install or operate a damaged unit. Contact the place of purchase.

■ Ensure that any plastic wrappings, bags etc. are disposed of safely and kept out of the reach of children. Danger of suffocation!

■ This dishwasher should only be installed under a continuous countertop secured to adjacent cabinetry.

■ Do not install this dishwasher beneath a cooking surface, oven or any appliance that radiates heat. High temperatures from these units may damage the dishwasher.

■ Do not, under any circumstances cut the intake hose or submerge in liquid. This hose contains electrical components that could cause injury or property damage if cut or submerged.

## Use

■ Only use the dishwasher if all panels are properly in place.

■ Do not tamper with the controls.

■ To reduce the risk of injury, do not allow children to play in, on, or near the dishwasher.

■ Do not damage, sit, or stand on the door or baskets of the dishwasher.

■ Under certain conditions, hydrogen gas may be produced in a hot water system that has not been used for two weeks or more. **HYDROGEN GAS IS EXPLOSIVE.** If the hot water system has not been used for such a period, turn on all hot water faucets and let water flow from each for several minutes before using the dishwasher. This will release any accumulated hydrogen gas. Do not smoke or use an open flame during this time.

■ Do not wash plastic items unless they are labeled "dishwasher safe" or the equivalent. For items not labeled, check the manufacturer's recommendations.

# IMPORTANT SAFETY INSTRUCTIONS

---

■ When loading tableware, place sharp items away from the door seal to prevent damage to the seal. Load knives pointing downwards to prevent injuries.

■ Only use detergents and rinse aids recommended for residential dishwashers. Keep all detergents and rinse aids out of the reach of children.

■ Do not drink water from the dishwasher! Harmful residues could be present.

## **For dishwashers with a visible heating element**

■ Do not touch the heating element during or immediately after use.

## **Disposal of an appliance**

■ If the appliance is removed from its installation and will not be used, the door to the wash cabinet should be removed to prevent children from being locked in the machine. When discarding an old dishwasher, unplug it from the power outlet, remove the door to the wash cabinet and cut off the power cord.

## **SAVE THESE INSTRUCTIONS**

# CONSIGNES DE SÉCURITÉ IMPORTANTES

## AVERTISSEMENT –

**Lorsque vous utilisez votre lave-vaisselle, veuillez prendre des précautions essentielles, y compris ce qui suit.**

**Lisez attentivement l'ensemble des consignes avant d'installer ou d'utiliser le lave-vaisselle afin de prévenir les blessures et éviter d'endommager l'appareil.**

Le fabricant ne peut être tenu responsable des dommages ou blessures causés par une utilisation inappropriée de l'appareil.

Utilisez le lave-vaisselle uniquement aux fins auxquelles il a été conçu. Cet appareil est destiné à un usage domestique uniquement.

Conservez ces instructions dans un lieu sûr et transmettez-les à tout utilisateur ultérieur.

## Sécurité électrique

■ Avant l'installation, assurez-vous que la tension et la fréquence indiquées sur la plaque signalétique correspondent bien à celles de l'alimentation électrique de la résidence afin de prévenir les blessures et d'éviter d'endommager l'appareil. Dans le doute, consultez un électricien qualifié.

■ Avant de procéder à l'installation ou à des travaux d'entretien, coupez l'alimentation électrique, soit en débranchant l'appareil, soit en faisant basculer le disjoncteur, soit en enlevant le fusible.

■ N'utilisez pas de rallonge pour brancher l'appareil à la source d'alimentation électrique. Les rallonges ne garantissent pas la sécurité requise pour l'appareil - si vous utilisez une rallonge, cela peut causer une surchauffe.

■ Assurez-vous que votre appareil est installé correctement et mis à la terre par un technicien qualifié. Pour garantir la sécurité électrique de l'appareil, il faut le raccorder à une installation de mise à la terre appropriée. Il est essentiel de respecter cette exigence de sécurité élémentaire. Dans le doute, faites vérifier l'installation électrique de la résidence par un électricien qualifié. Le fabricant ne peut être tenu responsable de dommages causés par l'absence d'une installation de mise à la terre ou une installation déficiente.

# CONSIGNES DE SÉCURITÉ IMPORTANTES

---

## Installation

■ L'installation et les réparations devraient être effectuées uniquement par un technicien de service autorisé Miele. Les travaux effectués par des personnes non qualifiées peuvent s'avérer dangereux et annuler la garantie.

■  ATTENTION - Risque d'incendie  
Ne recouvrez et n'écrasez jamais la fiche d'un appareil électrique. Assurez-vous que dans l'espace occupé par le lave-vaisselle, il y a suffisamment d'espace pour la fiche. Si vous installez le lave-vaisselle dans un espace trop petit, le cordon d'alimentation pourrait être comprimé ou une pression pourrait être exercée sur la fiche, ce qui risque de causer une surchauffe.

■ Cet appareil n'est pas conçu pour être utilisé sur un bateau ou dans des engins mobiles, comme des avions ou des véhicules récréatifs. Toutefois, son installation est possible dans certaines circonstances. Veuillez communiquer vos exigences particulières au détaillant Miele le plus près de chez vous ou au Service technique.

■ Vérifiez si votre lave-vaisselle n'a pas subi de dommage lors du transport. N'installez pas et n'utilisez pas un appareil endommagé. Communiquez avec le point de vente où vous l'avez acheté.

■ Assurez-vous de vous débarrasser correctement des emballages, sacs, matières plastiques et autres et de les tenir hors la portée de bébés et d'enfants. Risque de suffocation!

■ Le lave-vaisselle doit être installé uniquement sous un comptoir continu fixé à des armoires adjacentes.

■ N'installez pas ce modèle de lave-vaisselle sous une surface de cuisson, un four ou tout autre appareil qui diffuse de la chaleur. Les hautes températures émanant de ces appareils pourraient endommager le lave-vaisselle.

■ En aucun cas, vous ne devez couper le tuyau d'arrivée d'eau ou l'immerger, car il contient des composants électriques qui pourraient causer des blessures ou des dommages matériels.



# CONSIGNES DE SÉCURITÉ IMPORTANTES

---

## Utilisation

■ N'utilisez le lave-vaisselle que lorsque tous les panneaux sont bien en place.

■ Ne jouez pas avec les commandes.

■ Afin de diminuer le risque de blessures, ne laissez pas les enfants jouer près de l'appareil ni monter dedans ou dessus.

■ Évitez de malmener la porte ou les paniers du lave-vaisselle ou de vous y appuyer ou asseoir.

■ Dans certaines circonstances, un système d'eau chaude qui n'a pas servi durant deux semaines ou davantage peut produire de l'hydrogène. L'HYDROGÈNE EST UN GAZ EXPLOSIF. Si le système d'eau chaude n'a pas servi durant une telle période, ouvrez tous les robinets d'eau chaude et laissez l'eau couler plusieurs minutes avant d'utiliser le lave-vaisselle. Cette action libérera l'hydrogène qui aura pu s'y accumuler. Entre-temps, abstenez-vous de fumer et n'utilisez pas de flamme nue.

■ Ne lavez pas des articles en plastique qui ne portent pas la mention "va au lave-vaisselle" ou une formulation équivalente. Consultez les recommandations du fabricant pour les articles qui ne portent aucune mention à cet égard.

■ Au moment de charger la vaisselle, ne disposez pas les articles coupants à proximité du joint d'étanchéité de la porte afin d'éviter de l'endommager. Placez les couteaux avec la pointe vers le bas afin d'éviter les blessures.

■ Utilisez seulement les détergents et les produits de rinçage recommandés pour les lave-vaisselle à usage domestique. Conservez tous ces produits hors de la portée d'enfants.

■ Ne consommez pas l'eau du lave-vaisselle! Elle peut contenir des résidus dangereux.

## Lave-vaisselle munis d'un élément chauffant visible

■ Ne touchez pas l'élément chauffant pendant ou immédiatement après l'utilisation.

## Mise au rebut de l'appareil

■ Si vous désinstallez l'appareil et comptez ne plus vous en servir, détachez-en la porte pour éviter que des enfants s'y retrouvent enfermés. Lorsque vous mettez un lave-vaisselle au rebut, débranchez-le de la source d'alimentation électrique, détachez-en la porte et coupez le cordon d'alimentation.

# CONSERVEZ CES CONSIGNES

# Caring for the environment

---

## Energy saving washing

This dishwasher is exceptionally economical in the use of water and electricity. For best results follow these tips:

- For lowest energy consumption and the gentlest washing of china and crystal, connect the dishwasher to a cold water source.
- For fastest possible wash times, yet higher energy consumption, connect the dishwasher to a hot water source.
- Make full use of the baskets without overloading for the most economical washing.
- Choose a program that best suits the degree of soiling and the type of dishes being washed.
- If baskets are only half full, select the "Economy" program.
- Use the correct amounts of detergent and rinse aid.

## Wash cabinet

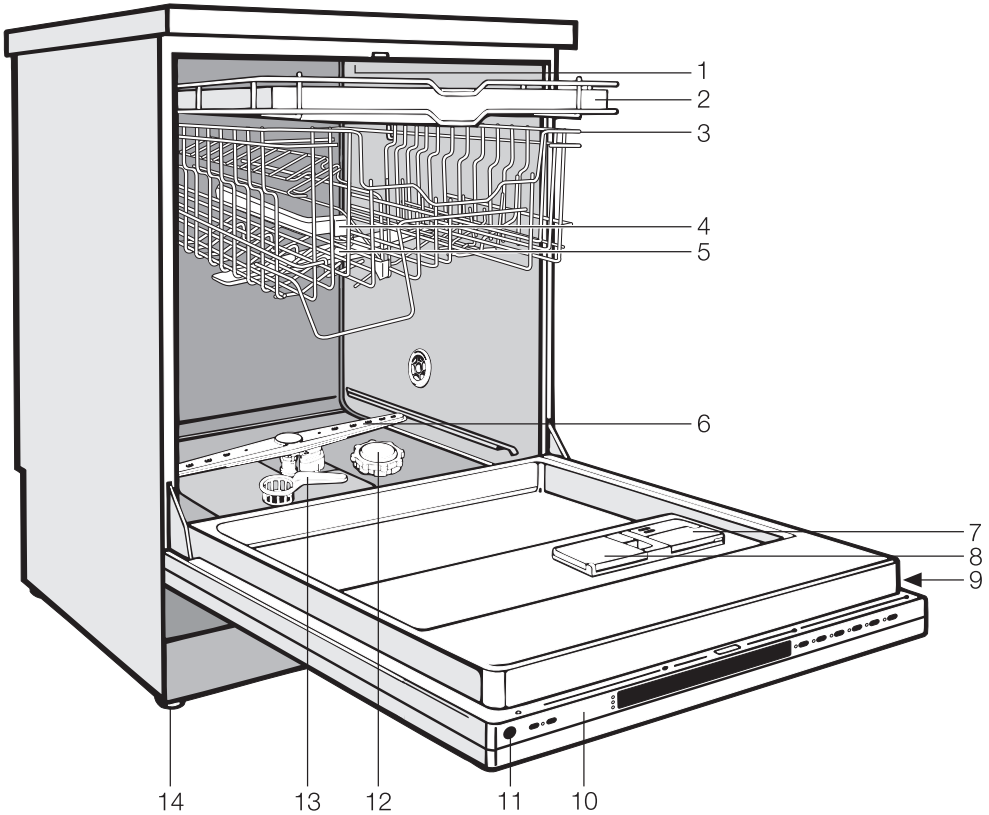

- |   |                                 |    |                             |
|---|---------------------------------|----|-----------------------------|
| 1 | Upper spray arm (not visible)   | 8  | Detergent dispenser         |
| 2 | Cutlery tray                    | 9  | Data plate                  |
| 3 | Upper basket                    | 10 | Control panel               |
| 4 | Water feed for middle spray arm | 11 | Optic indicator             |
| 5 | Middle spray arm                | 12 | Salt reservoir              |
| 6 | Lower spray arm                 | 13 | Triple Filter System        |
| 7 | Rinse aid reservoir             | 14 | Four height adjustable feet |

# Guide to the dishwasher

## Control panel



- 15 On button / Indicator
- 16 Off button
- 17 Check / Refill indicators
- 18 Program list
- 19 Program selection buttons / indicators

### Note:

Remove the protective film from the program list before the first use.

Every dishwasher is tested before leaving the factory. Any water remaining in the machine is from these tests and does not indicate that the machine has been used.

## Before using for the first time

---

### To open the door

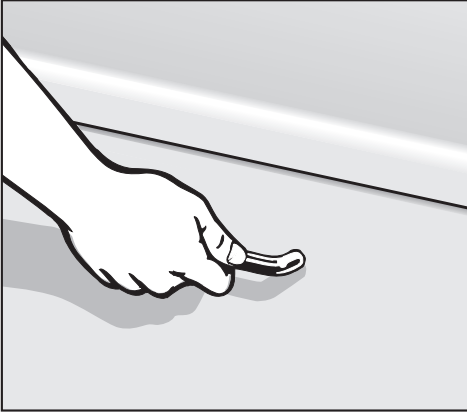

- Pull the handle.

If the door is opened during operation, the dishwasher will stop running. Once the door is closed the program will restart.

Instructions on how to open the dishwasher if a door panel has not yet been installed can be found in the Installation Instructions.

### To close the door

- Push the baskets in.
- Lift the door and push until it clicks into position.

# Before using for the first time

---

## Water softener

To achieve good cleaning results, the dishwasher needs soft water. Hard water results in calcium deposits on dishware and in the dishwasher.

If your tap water hardness is above 8 gr/gal (values are in US gallons) (140 ppm), the water should be softened. This takes place automatically in the unit's integrated water softener.

- Your local water authority will be able to advise you of the water hardness level in your area.
- The dishwasher must be programmed to correspond with the water hardness in your area.
- The water softener must be filled with dishwasher salt for reactivation.

If your water hardness is consistently **lower than 8 gr/gal (140 ppm), you do not need to add dishwasher salt.**

However, the dishwasher must still be programmed to correspond with the local water hardness.

Where the water hardness fluctuates e.g. between 9 - 17 gr/gal (160 - 310 ppm), always program the machine to the higher value, 17 gr/gal (310 ppm) in this example.

If there is a fault, it will help the service technician to know the hardness of your local water supply.

■ Please note your water hardness:

\_\_\_\_\_ gr/gal

# Before using for the first time

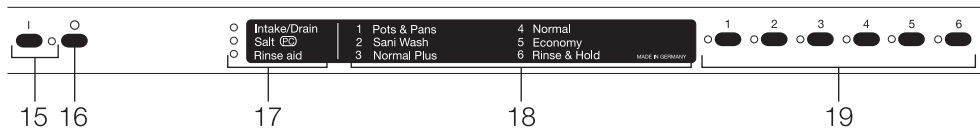

## Programming the water softener

Your water hardness level must be programmed into the dishwasher using the buttons on the control panel.

The programming can be canceled and restarted at any time by turning the dishwasher off using the "Off" button, (16).

- Open the door.
- Turn off the dishwasher.
- Press and hold the ① and ③ buttons. At the same time turn on the dishwasher with the "On" (15) button.

- Release all buttons.

The "Salt" and ② indicators will flash. If this is not the case, the above steps must be repeated.

- Press the ② button.

The ② indicator goes out and the "Salt" indicator will flash.

If your water hardness is greater than 12 gr/gal (220 ppm) proceed to the next page.

## 1 - 12 gr/gal:

An indicator corresponding to a preset water hardness will light (see Table 1).

**Table 1:**

gr/gal*	ppm	Button
1 - 4**	20 - 70	①
5 - 6	90 - 110	②
7	130	③
8 - 10	140 - 180	④
11 - 12	200 - 220	⑤

\* US gallons

\*\* Factory preset

If this value corresponds with the water hardness in your area:

- Turn off the dishwasher.

If you need to program a different water hardness:

- Press the button, which corresponds with your water hardness (see Table 1).

The "Salt" and ② indicators will flash.

- Press the ⑥ button twice.

The "Salt" and ⑥ indicators will flash.

The new water hardness is set.

- Turn off the dishwasher.

# Before using for the first time

---

## 13 - 70 gr/gal:

- Press the ⑥ button.

The ⑥ indicator will light.

An indicator corresponding to a set water hardness will light (see Table 2).

**Table 2:**

gr/gal	ppm	Button
13	230	①
14 - 16	250 - 290	②
17 - 22	310 - 400	③
23 - 35	410 - 630	④
36 - 70	650 - 1260	⑤

If this value corresponds with the water hardness in your area:

- Turn off the dishwasher.

If you need to program a different water hardness:

- Press the button which corresponds to your water hardness (see Table 2).

The "Salt" and ② indicators will flash.

- Press the ⑥ button twice.

The "Salt" and ⑥ indicators will flash.

The new water hardness is set.

- Turn off the dishwasher.

## Checking the programmed water hardness

- Open the door.
- Turn off the dishwasher.
- Press and hold the ① and ③ buttons. At the same time turn on the dishwasher with the "On" (15) button.
- Release all buttons.

The "Salt" and ② indicators will flash. If this is not the case, the above steps must be repeated.

- Press the ② button.

The programmed water hardness is indicated by:

## 1 - 12 gr/gal

Corresponding indicator is lit, (see Table 1).

- If an indicator is not lit, press the ⑥ button.

## 13 - 70 gr/gal:

The ⑥ indicator and an additional corresponding indicator is lit, (see Table 2).

- Turn off the dishwasher.



## Before using for the first time

### Filling the salt reservoir

If your water hardness level is greater than 8 gr/gal, the salt reservoir should be filled before the first use and when the "Salt" indicator lights.

Only use water softener salt specially formulated for dishwashers. Other salts may contain insoluble additives which can impair the water softener.

The proper salt can be purchased from your Miele dealer or Miele.

 **Inadvertently filling the salt reservoir with dishwashing detergent will damage the water softener.**

### To fill the salt reservoir:

- Remove the lower basket.
- Unscrew and remove the salt reservoir cap located on the floor of the wash cabinet.
- Place the provided funnel over the salt reservoir.

The salt reservoir must be filled with 2 quarts (2 l) of water **before adding salt for the first time**. Water does not have to be added with subsequent refills.

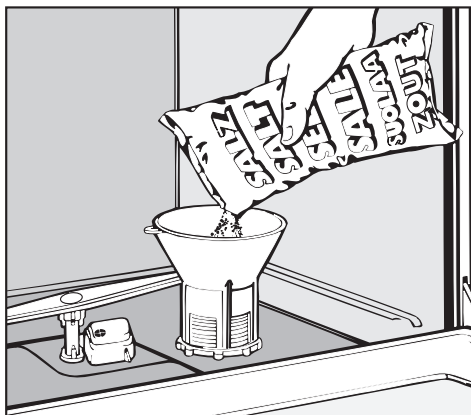

- Carefully fill with salt. The salt reservoir holds approximately 4.5 lbs (2 kg) of salt. As it is filled, water will run out.
- Clean any excess salt from the threads of the reservoir opening.
- Screw the cap on firmly.
- If the dishwasher will not be used immediately, run the "Rinse & Hold" program. This will remove any traces of salt from inside the wash cabinet.

## Before using for the first time

### Salt indicator

When the salt reservoir is empty, the "Salt-PC" indicator will light, indicating that it should be refilled with reactivation salt.

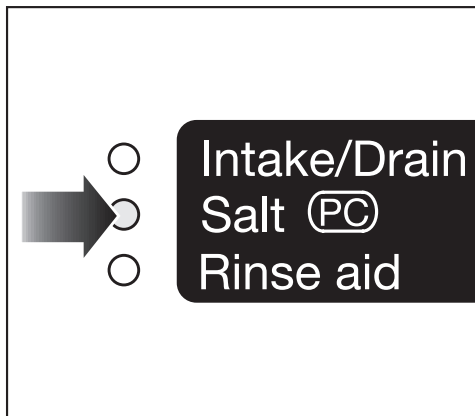

After the reservoir has been filled, the water softener is automatically reactivated the next time the dishwasher is started. The "Salt" indicator will be lit during this process.

### Bypassing the salt indicator

If your water is soft (below 8 gr/gal) the salt reservoir should not be filled with salt. The indicator will remain lit and should be disregarded or bypassed.

- Remove the salt reservoir cap.

Looking into the salt reservoir, you will see the top of the float chamber on the right hand side, ①.

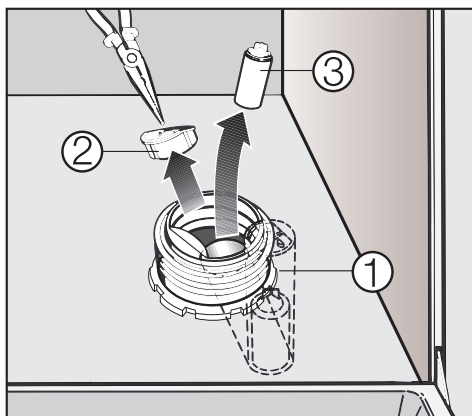

- Using a screwdriver, carefully pivot the float chamber towards the center of the reservoir.
- Using needle nose pliers, pull the cap, ②, off of the float chamber, and remove the float, ③.

Replace the float chamber cap, push the chamber back into its upright position, and replace the salt reservoir cap. The "Salt" indicator should no longer be lit.

## Before using for the first time

### Rinse aid

Rinse aid is recommended to prevent spotting on dishes and glassware.

⚠ Filling the rinse aid reservoir with detergent will damage the reservoir. Only pour rinse aid formulated **for residential dishwashers** into the reservoir.

### Adding rinse aid

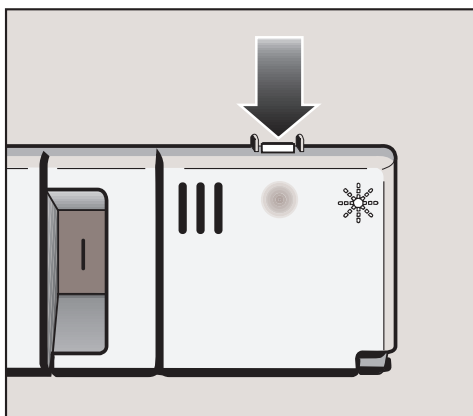

- Add rinse aid before the first use and whenever the "Rinse aid" indicator lights.
- Press the button in the direction of the arrow until the flap springs open.

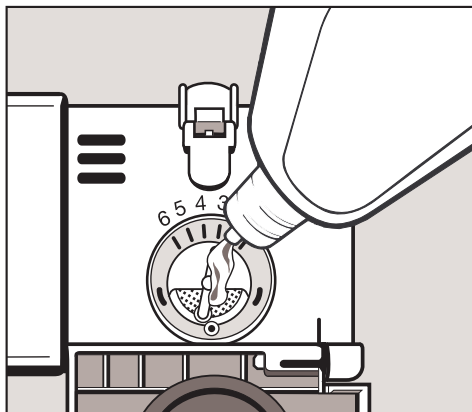

- Pour liquid rinse aid into the reservoir until it is visible on the surface of the screen.
- Press on the flap until you hear it click shut. Failure to close it all the way will allow water to enter the reservoir during the wash program.
- Wipe up any spilled rinse aid. The flap will remain closed during normal operation.

## Before using for the first time

---

### Adjusting the dosage

The dosage selector is preset to 3. This dispenses approximately 3 ml of rinse aid per program. It can be adjusted from 1 to 6.

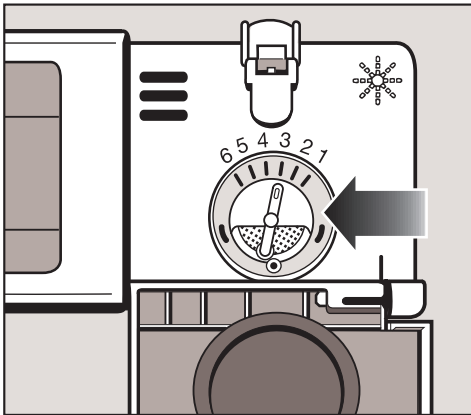

- Use a higher setting if spots appear on dry glassware.
- Use a lower setting if streaking appears on dishes or glasses.

### Rinse aid indicator

The rinse aid indicator on the control panel will light when the rinse aid reservoir needs refilling.

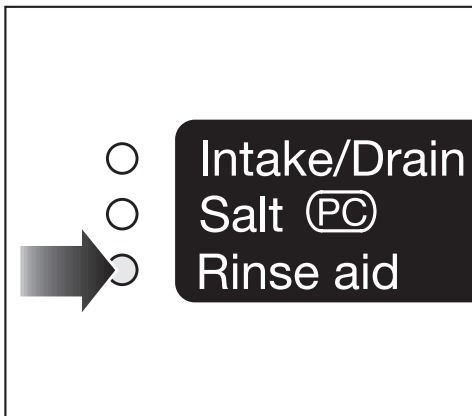

When the indicator first comes on, there will be enough rinse aid left for 2 - 3 washes.

## Loading the dishwasher

 Do not wash items soiled with ash, sand, wax, grease or paint in the dishwasher.

Ash and sand do not dissolve and will be distributed throughout the inside of the dishwasher.

Wax, grease and paint will cause permanent discoloration or damage to the dishwasher.

- Scrape food from dishes before placing in the dishwasher.  
**Do not rinse dishes.**
  - Load dishes so that water can reach all surfaces. Do not place dishes and cutlery inside other pieces.
  - Hollow items such as cups and glasses should be placed upside down in the upper basket.
  - Concave based items, such as mugs or bowls, should be placed at an angle so that water does not pool.
  - To ensure good water coverage tall, narrow, hollow pieces, such as a vase, should be placed in the center of the basket, rather than in the corners.
  - Small cups and glasses should be placed on the cup racks. Taller mugs and glasses can be placed beneath the rack.
  - Place very small items in the cutlery tray or basket so they do not fall to the bottom of the wash cabinet.
- The spray arms must not be blocked by items that are too tall or hang through the baskets. Check clearance by manually rotating the spray arms.
  - Food residue and spilled liquids should be cleaned from the sides of the dishwasher door. These are outside of the wash cabinet and are not cleaned by water from the spray arms.

# Loading the dishwasher

---

## Items not recommended for dishwashing

- Cutlery with wooden handles.
- Wooden cutting boards.
- Glued items such as old knives with handles glued together around the shank of the blade.
- Hand made craft items, antique, metal trimmed or decorative glassware.
- Lead crystal.
- Copper, brass, tin or pewter.
- Plastic items that are not heat resistant.
- Dishes with color painted over the glaze. These dishes may fade over time.
- Cast iron pots and pans.

## Glassware:

- There are no standard guidelines for washing glassware but, when in doubt wash by hand.
- Wash delicate glassware with a low temperature program and without the extended drying feature to reduce the risk of clouding. See the "Program guide".
- If crystal or delicate glasses will be washed frequently, connect the dishwasher to cold, rather than hot water.
- Clouding or etching may occur on glasses after frequent washing.
- When purchasing new dishes, glasses and cutlery, make sure they are dishwasher safe.

## Silver and aluminum:

- Silver or aluminum items may tarnish.
- Silverware previously cleaned with a silver polish may be damp or spotted at the end of a program where water has adhered to the polish. This can be rubbed off with a soft, dry cloth. Silver that has been cleaned in an immersion dip is usually dry at the end of a program, but may tarnish.
- If left to dry, foods containing sulfur can discolor silver. These include egg yolk, onions, mayonnaise, mustard, fish and marinades.
- Silverware may tarnish or pit if washed next to stainless steel. Leave space between these metals.

## Cutlery basket

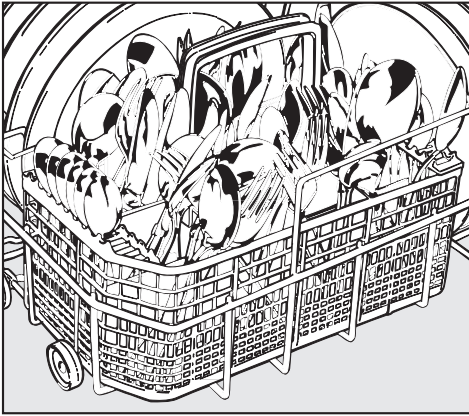

- For the best cleaning results, spoons and forks should be placed in the basket with handles down. Knives and other pointed objects can be loaded with their handles up to prevent injuries.
- Place small spoons into the slots on either side of the cutlery basket.

# Loading the dishwasher

## Cutlery tray (SC units)

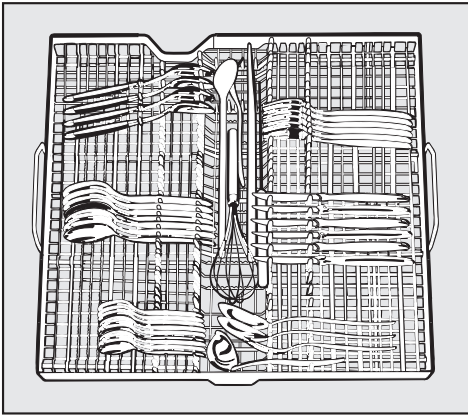

The removable cutlery tray makes unloading flatware easy. Simply carry the cutlery tray to where the flatware is stored and put the entire basket away in one trip.

For easier unloading cutlery should be grouped in zones, one for knives, one for forks, one for spoons, etc.

Place knives with the cutting edge and forks with the prongs between the holders. Spoons should be placed in the opposite direction with the handles between the holders.

Longer items such as soup ladles, cake slices, mixing spoons and long knives should be placed lengthwise in the indentation of the cutlery tray.

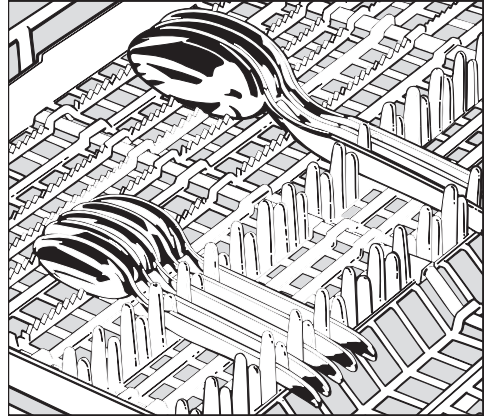

Spoon heads should be placed in contact with at least one of the serrated retainers of the cutlery tray to ensure that water runs off freely.

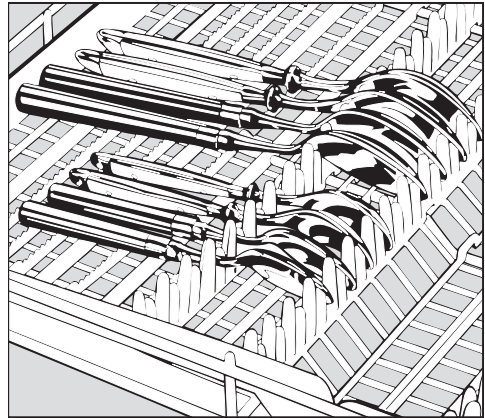

Spoons with thick handles may have to be placed as knives and forks with their heads in the holders.



# Loading the dishwasher

## Upper basket

### Adjusting the upper basket

On select models, the upper basket can be raised or lowered to accommodate tall items.

- Slide out the upper basket.

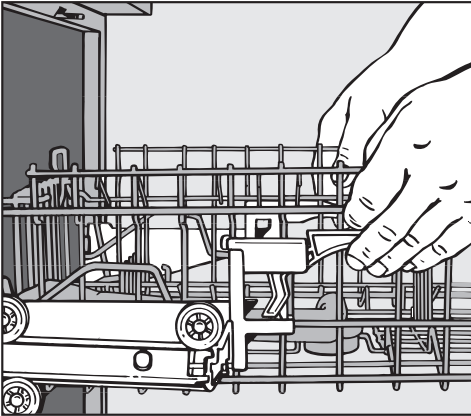

- Pull up the levers at the sides of the upper basket and adjust the basket height.
- Release the levers and the basket will lock in place.

The basket can also be angled to fit tall items in both, the lower and upper baskets. The angles should not be set to opposite extremes. This will block the middle spray arm. Take care when sliding the basket in and out in this position.

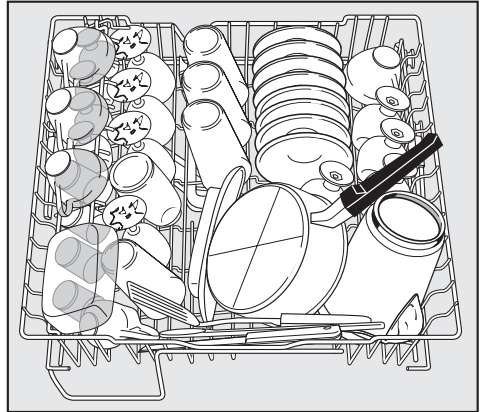

Load the upper basket with small, lightweight, or delicate items such as cups, saucers, glasses, dessert bowls and flat pans.

Long items such as soup ladles, mixing spoons and knives can be set across the front of the upper basket.

# Loading the dishwasher

---

## Adjustable cup racks

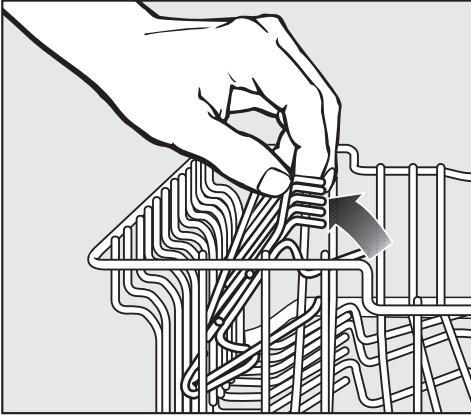

Raise the rack to make room for tall glasses. Lower it to double stack smaller pieces.

## Coffee bar

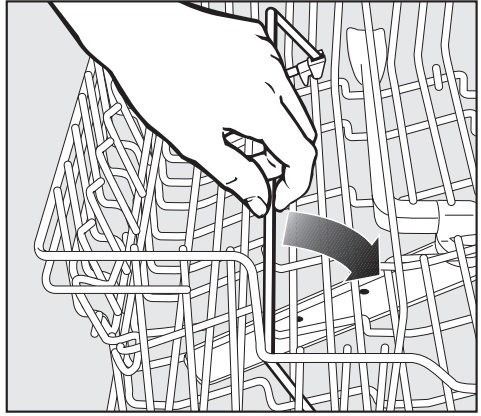

To allow water to run off the bottom of coffee mugs, place them slanted on top of the coffee bar. The bar can also be used to separate two rows of glasses. To stack wide items, flip the bar to the right.

# Loading the dishwasher

## Lower basket

For larger and heavier items such as plates, serving platters, sauce pans, bowls.

## Dishwasher with cutlery tray

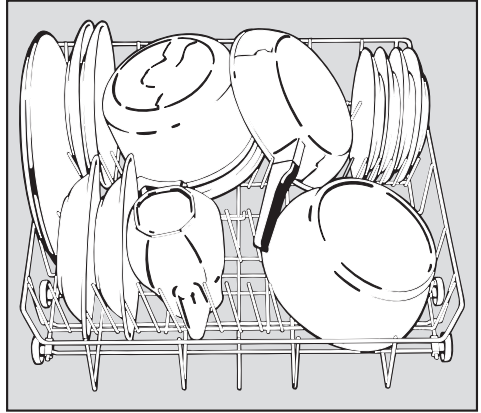

## Dishwasher with cutlery basket

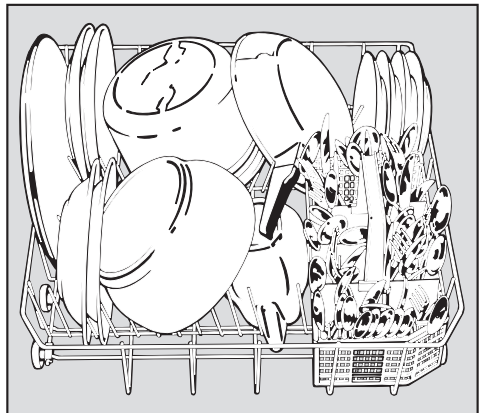

# Loading the dishwasher

## Height limit

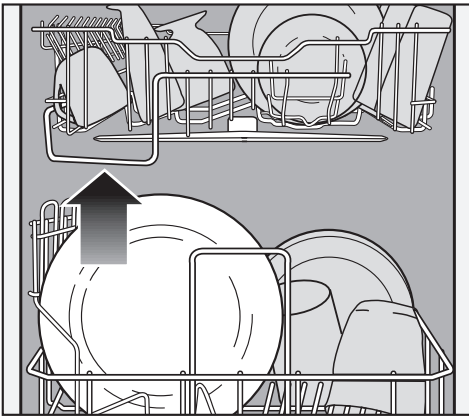

The guide at the front of the upper basket determines the maximum height for items placed in the lower basket so that the middle spray arm is not blocked.

## Foldable spikes

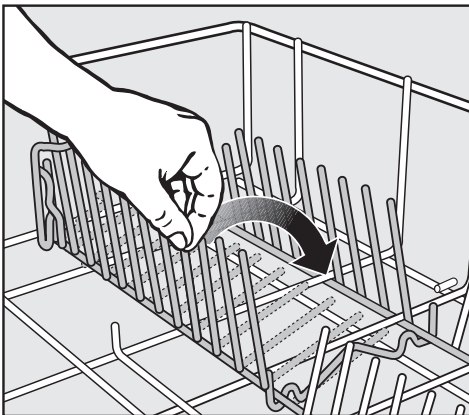

Two rows of spikes can be folded down, to create more room for larger dishware e.g. pots, pans and bowls.

- Lift up the spike rows and fold them one on top of the other.

## Vase / Bottle holder (select models)

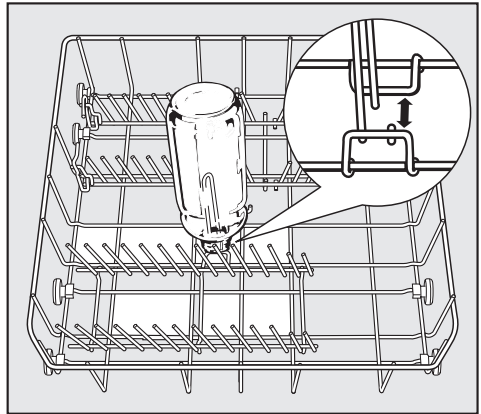

The bottle holder e.g. for milk or baby bottles, can be inserted into the bottom basket in more than one place. Position in any area marked white in the illustration. Do not place the insert in the corners of the lower basket, water cannot properly cover bottles in these areas.

## Basket accessories

---

Additional inserts for the upper and lower baskets may be purchased from your Miele dealer or the Miele Technical Service Department.

Vase / Bottle holder

To wash milk or baby bottles  
attaches to the lower basket

---

Mini Cutlery Basket

To wash additional cutlery  
for units with cutlery tray  
attaches to the lower basket

---

Upper Basket Glassware Insert

To wash long stemmed glassware  
attaches to the upper basket

# Operation

## Adding detergent

 Dishwasher detergents contain irritant and corrosive ingredients. Keep children away from detergent. Do not fill the detergent dispenser until you are ready to start the dishwasher.

Only use **powder** detergents or **tablets** formulated for residential dishwashers. The use of gel or liquid detergent is not recommended. Never fill the detergent dispenser to capacity. Do not use more than the recommended amount of detergent. Continued use of too much detergent may cause machine damage.

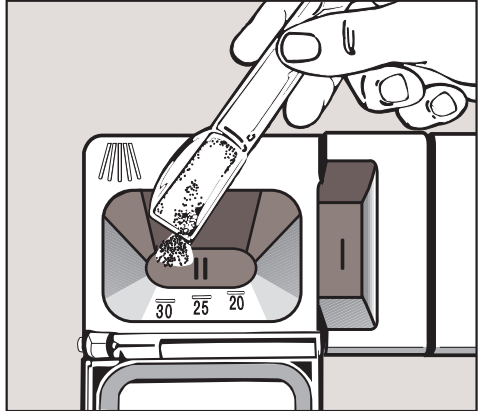

The horizontal marks in Compartment II indicate levels of approximately 1  $\frac{1}{4}$ , 1  $\frac{3}{4}$  and 2 tablespoons (20, 25 and 30 ml) respectively.

- With the dishwasher door fully open fill compartment II with 2 tablespoons (30 ml) of powder detergent or one detergent tablet.
- Close the cover. The cover will always open at the end of a wash program except in "Rinse & Hold".

2 tablespoons (30 ml) of detergent is enough for most normally soiled loads. For heavily soiled loads, or if food has dried on the dishes, a program containing a prewash cycle should be selected. Add an extra tablespoon (15 ml) of detergent to compartment I.

Less detergent is needed in homes with very soft water and when washing lightly soiled dishes.

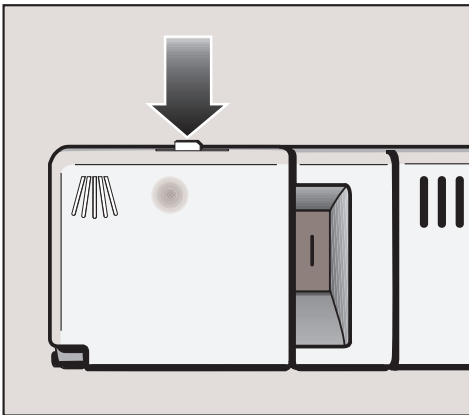

- To open, press the latch on the detergent dispenser.



## Running the dishwasher

- Open the door.
- Make sure the spray arms are not blocked.
- Turn on the dishwasher using the "On" button (15).
- Select a wash program using the program selection buttons (19). Refer to the "Program guide" for details.

The selected program indicator will light.

- Close the door.

The optic indicator will come on.

The program will begin.

Do not end a program prematurely! Important program steps could be omitted (e. g. reactivating the water softener).

## Waterproof System

All Miele dishwashers are specially designed to shut off the water intake and drain the wash cabinet in the rare event of an internal water valve failure.

For this feature to be active, the machine must be "On" (not necessarily running), and the door must be closed.

## At the end of a program

At the end of a program the optic indicator will flash.

The optic indicator will go out after an hour or sooner if the door is opened.

After a program has ended:

- Open the door.

The optic indicator and the program indicator will go out.

- Press the "Off" button (16).

Allow dishes to cool before unloading.

It is advisable to turn off the water supply if the dishwasher will not be used for a period of time (e.g. while vacationing).

# Operation

---

## Interrupting a program

A program is interrupted as soon as the door is opened.

If the door is closed, the program will continue from where it was interrupted.



Water in the dishwasher may be hot. There is a danger of being burned!

Only open the door if absolutely necessary.

## Changing a program

If the door has not been closed yet:

- Press the program button of the new program.
- Close the door.

The program will begin.

If the door has already been closed and the program is running:

- Open the door.
- Press the "Off" button (16).
- Press the "On" button (15).
- Select a program with the program selection buttons (19).
- Close the door.

The program will begin.



## Program guide

Program	When to use	Program cycle				
		Pre-wash 1 2	Main wash	Interim rinse 1 2	Final rinse	Dry- ing
Pots & Pans	For heavily soiled pots and pans with dried on food Main wash temperature <b>170 °F (75 °C)</b> Run-time <b>142 min</b>	X X	X	X -	X	X
Sani Wash	Eextended wash time For <b>sanitizing normally soiled dishware with dried on food</b> Main wash temperature <b>150 °F (65 °C)</b> Run-time <b>147 min</b>	- X	X	X X	X	X
Normal Plus	Higher wash temperature helps to clean <b>normally soiled dishware with stubborn dried on food or greasy residues</b> Main wash temperature <b>150 °F (65 °C)</b> Run-time <b>145 min</b>	X X	X	X -	X	X
Normal <sup>1)</sup>	For <b>normally soiled dishware</b> Main wash temperature <b>130 °F (55 °C)</b> Run-time <b>143 min</b>	X X	X	X -	X	X
Economy	Energy saving program For normally soiled dishware Main wash temperature <b>130 °F (55 °C)</b> Run-time <b>103 min</b>	- -	X	X -	X	X
Rinse & Hold	For rinsing dishes when a complete cycle is not needed Run-time <b>11 min</b>	- X	-	- -	-	-

1) Standard for Energy Label

When washing a full load in Pots & Pans, Sani Wash and the Normal programs use at least 2 tablespoons (30 ml) of detergent.

For the Pots & Pans program add an additional teaspoon (5 ml) to compartment I.

If "Top Solo" is selected, reduce the amount of detergent to 1  $\frac{1}{4}$  tablespoons (20 ml).

Program times are based on a hot water connection. If the unit is connected to cold water, program times will increase by approximately 25 minutes.

### Usage:

Electric: 0.06 - 2.4 (kWh)

Water: 1.3 - 6.3 US gallons (5 - 24 L)

## Frequently asked questions

With the aid of the following guide, minor problems can be fixed without a service call.

 Repairs should only be carried out by a qualified and trained technician in accordance with local and national safety regulations. Unauthorized repairs could cause personal injury or machine damage.

<b>What if ...</b>	<b>Possible fault</b>	<b>Fix</b>
<b>the dishwasher does not start?</b>	The door is not properly closed.	Close the door firmly.
	The machine is not plugged in.	Insert the plug.
	The fuse is defective or the breaker has tripped.	Reset the circuit breaker. Make sure it is a 15 A circuit breaker.
	The dishwasher is not turned on.	Press "On", select program.
	No program is selected.	Select a program with the program selection buttons.
<b>the dishwasher stops during a program?</b>	The fuse or breaker has tripped.	Reset the circuit breaker. Make sure it is a 15 A circuit breaker.
<b>the dishwasher stops running, shortly after starting a program and the optic indicator flashes?</b>	Water intake error. The "Intake/Drain" indicator flashes/lights.	<ul style="list-style-type: none"><li>– Turn off the dishwasher.</li><li>– Open the water valve.</li><li>– Clean the water inlet filter, see maintenance instructions.</li></ul> The waterproof system has activated. <ul style="list-style-type: none"><li>– Call the Miele Technical Service Department.</li></ul>

## Frequently asked questions

What if ...	Possible fault	Fix
<b>shortly after starting a program, the dishwasher stops running and the optic indicator flashes?</b>	<p>Water intake error. The "Intake/Drain" indicator flashes.</p> <p>Drain error, water remains in the wash cabinet. The "Intake/Drain" indicator flashes.</p>	<p>The water pressure is less than 4.5 psi (0.3 bar). Contact a plumber.</p> <ul style="list-style-type: none"> <li>– Turn off the dishwasher.</li> <li>– Clean the triple filter. See maintenance instructions.</li> <li>– Clean the drain pump and the non-return valve, see maintenance instructions.</li> <li>– Remove any kinks in the drain hose.</li> </ul>
<b>after starting a program, the optic indicator does not shine?</b>	<p>The optic indicator reflector was not placed in the steam deflector properly.</p>	<p>Install the optic indicator reflector correctly. See Installation manual, "1. Install the steam deflector".</p>

## Frequently asked questions

<b>What if ...</b>	<b>Possible fault</b>	<b>Fix</b>
<b>after a program has ended, the optic indicator and the program indicators flash?</b>	There may be a technical fault.	– Turn the dishwasher off. Despite the problem the dishwasher can be used. If the indicators flash again after the next program cycle, call Miele Technical Service.
<b>there is a knocking noise in the wash cabinet?</b>	The spray arm is hitting an item in the basket.	Interrupt the program, rearrange items blocking the spray arms.
<b>there is a rattling noise?</b>	Items are not secure in the wash cabinet.	Interrupt the program and rearrange loose pieces.
<b>there is a knocking noise in the water pipes?</b>	This may be caused by the installation or diameter of the pipes.	This has no effect on the dishwasher. If in doubt contact a plumber.
<b>dishes are not dry, glasses and cutlery are spotted?</b>	The rinse aid setting may be too low, or the rinse aid reservoir is empty.	Increase the dosage or refill the reservoir, see "Before using for the first time".
	Dishes were taken out too soon.	Leave dishes in longer.

## Frequently asked questions

<b>What if ...</b>	<b>Possible fault</b>	<b>Fix</b>
<b>dishes are not clean?</b>	The dishes were not loaded correctly.	See "Loading the dishwasher".
	The program was not powerful enough.	Select a more intensive program, see the "Program guide".
	Not enough detergent was used.	Use more detergent, see "Adding detergent".
	The spray arm jets are clogged.	Clean the spray arm jets, see "User Maintenance Instructions".
	The triple filter is clogged or not correctly seated.	Clean and reseal the filter, see "User Maintenance Instructions".
	The drain pump or the non-return valve is blocked.	Clean the drain pump and the non-return valve, see "User Maintenance Instructions".

## Frequently asked questions

<b>What if ...</b>	<b>Possible fault</b>	<b>Fix</b>
<b>tea or lipstick stains have not been completely removed?</b>	The wash temperature of the selected program was too low.	Select a program with a higher temperature.
	Not enough detergent was used.	Use more detergent.
<b>white residue is visible on cutlery and dishes, clouding occurs on glassware and film can be wiped off?</b>	Not enough rinse aid was used.	Increase the dosage, see "Before using for the first time".
	The salt reservoir is empty.	Add reactivation salt, see "Before using for the first time".
	The salt reservoir cap was not correctly screwed on.	Reseat it making sure it screws back on correctly.
	The programmed setting of the water softener is too low.	Adjust the setting of the water softener, see "Before using for the first time".
<b>there are smears on glasses and cutlery, bluish sheen on the surface of glasses and film can be wiped off?</b>	The rinse aid dosage is set too high.	Reduce the dosage, see "Before using for the first time".
<b>glasses are dull and discolored and film cannot be wiped off?</b>	Glasses are not dishwasher safe.	There is no remedy. Only wash dishwasher safe glasses.

## Frequently asked questions

<b>What if ...</b>	<b>Possible fault</b>	<b>Fix</b>
<b>plastics are discolored?</b>	Natural dyes e.g. from vegetables may be the cause. Not enough detergent was used to break down natural dyes.	Use more detergent, see "Adding detergent". Discoloration is permanent.
<b>there are rust stains on cutlery?</b>	The salt reservoir cap was not screwed on properly.	Reseat and screw the cap on firmly.
	The affected items are not corrosion resistant.	There is no remedy. Only wash dishwasher safe cutlery.
<b>the detergent dispenser lid cannot be closed properly?</b>	Detergent residue is blocking the catch.	Remove the residue.
<b>detergent is left in the dispenser at the end of a program?</b>	The dispenser was damp when detergent was added.	Dry the dispenser before adding detergent.
<b>water remains in the wash cabinet at the end of a program?</b>	The triple filter in the wash cabinet is clogged.	Clean the filter, see "User Maintenance Instructions".
	The drain pump or the non-return valve may be blocked.	Clean the drain pump and the non-return valve, see "User Maintenance Instructions".
	The drain hose is kinked.	Remove the kink.

## After sales service

---

In the event of a fault which you cannot correct yourself please contact the Miele Technical Service Department.

**(USA)** 1-800-999-1360  
techserv@mieleusa.com

**(CDN)** 1-800-565-6435  
service@miele.ca

When contacting the Miele Technical Service Department, please quote the model and serial number of your appliance.

These can be found on the data plate on the upper inside edge of the dishwasher door.

### Program update function - PC

The Program Correction (PC) allows a technician to update the dishwasher to make use of new technology.

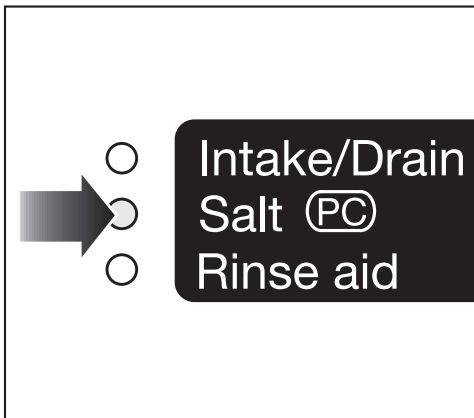

For example, if a detergent with good wash results using only cold water becomes available, the wash programs can be modified to take advantage of this.

## MieleCare

**MieleCare**, our Extended Service Contract program; gives you the assurance of knowing that your appliance investment is covered by 5 years of worry free ownership.

**MieleCare** is the only Extended Service Contract in the industry that guarantees repairs by a Miele Authorized Service Provider using genuine Miele parts. Only genuine Miele parts installed by factory trained professionals can guarantee the safety, reliability, and longevity of your Miele appliance.

Please note that unless expressly approved in writing by Miele's Service department, Extended Service Contracts offered by other providers for Miele products will not be recognized by Miele. Our goal is to prevent unauthorized (and untrained) service personnel from working on your Miele products, possibly doing further damage to them, you and/or your home.

To learn more about **MieleCare** Extended Service Contracts, please contact your appliance dealer or visit us online at:

[www.miele.com/mielecare/mielecarehome.asp](http://www.miele.com/mielecare/mielecarehome.asp)



To transport the dishwasher, e.g. when moving to a new home, note the following:

- Empty the dishwasher.
- Secure any loose parts, e.g. hoses, cables, cutlery baskets.
- Transport the dishwasher in the upright position. If unavoidable it may be transported on its back. Do not transport it on its side or on the door. Residual water in the machine could leak and cause electrical damage.



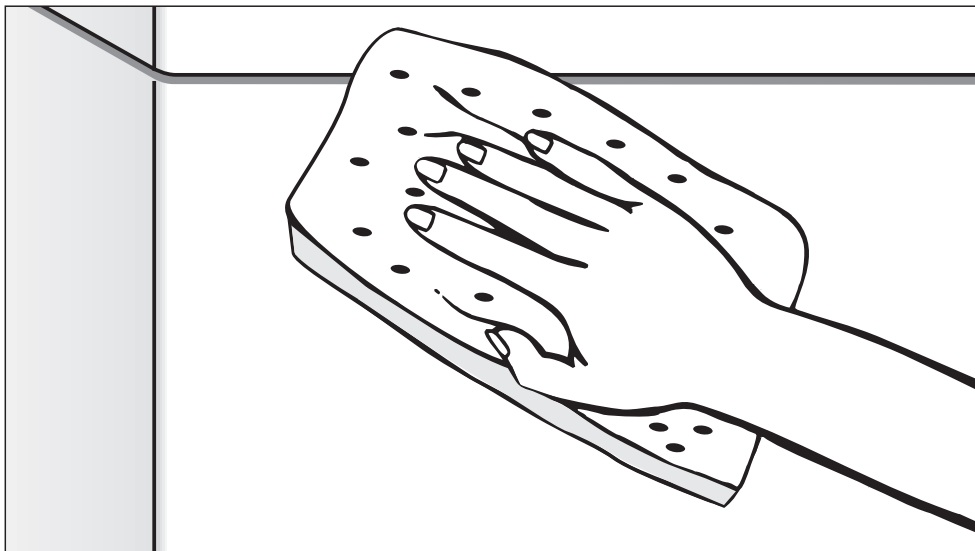

## User Maintenance Instructions

To prevent accidents  
and machine damage,  
read these instructions  
**before** installation or use.

# Cleaning and Care

## Triple filter system

The triple filter system in the base of the wash cabinet prevents food from being redeposited on dishes. It also protects the circulation pump from damage caused by foreign objects (e.g. broken glass, bones).

The filter system should be cleaned every 4 - 6 months or whenever a foreign object is trapped.

## Cleaning the filter in the wash cabinet

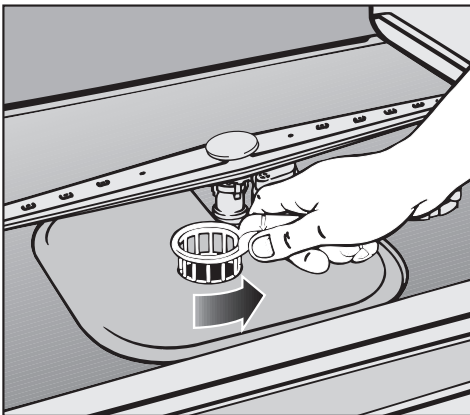

- Turn off the dishwasher before cleaning.
- Turn the handle counterclockwise to release the triple filter system.

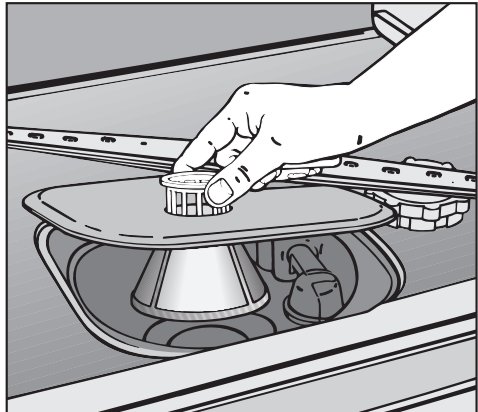

- Lift the filter out of the machine. Remove any solid particles and rinse under running water. Scrub with a nylon brush if necessary.

## Cleaning and Care

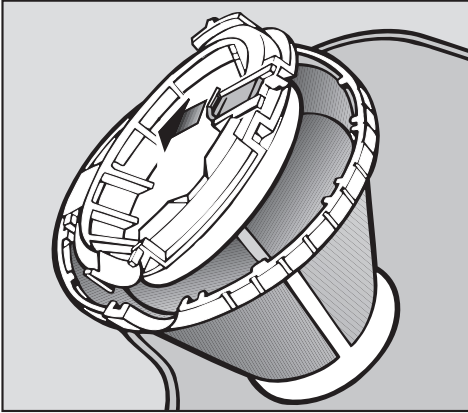

To clean the underside of the filter, the flap must be opened:

- Pull back the yellow clip.
- Rinse all parts under running water. Scrub with a nylon brush if necessary.
- Close the flap so that the clip engages.

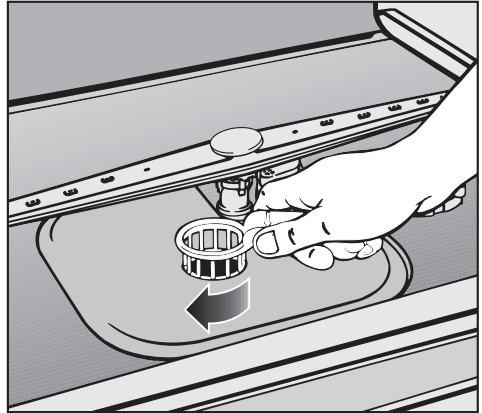

- Return the filter so it lies flat in the base of the wash cabinet.
- Lock the filter by turning the handle clockwise.

 The dishwasher must not be used without the filter locked in place.

# Cleaning and Care

## Cleaning the spray arms

Sometimes particles of food get stuck in the spray arm jets. The spray arms should be inspected and cleaned every 4 - 6 months.

- Turn off the dishwasher before cleaning.

Remove the spray arms as follows:

- Remove the cutlery tray (if present).
- Press the **top** spray arm upwards to engage the inner ratchet and unscrew the spray arm.

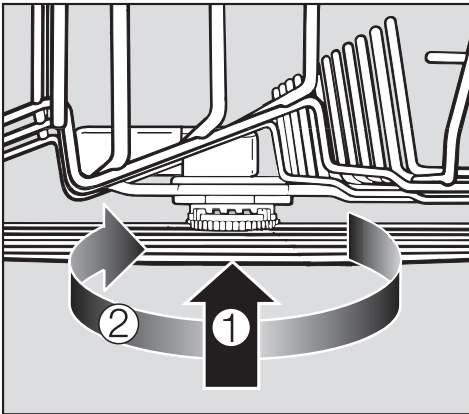

- Lift up the **middle** spray arm, ①, to engage the ratchet and unscrew the spray arm, ②.

- Remove the lower basket.

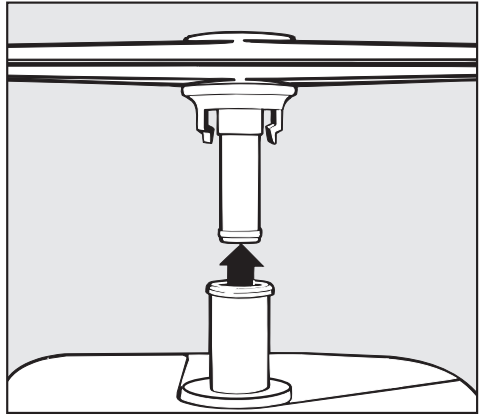

- Pull the **lower** spray arm firmly upwards to remove.

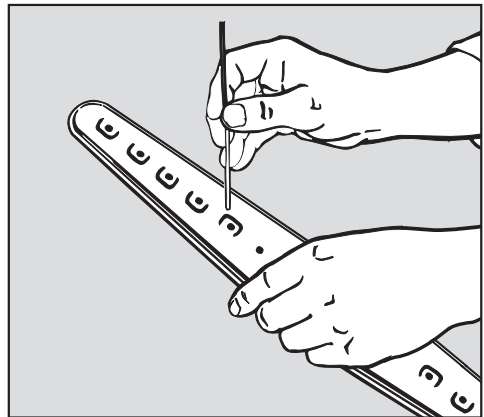

- Use a pointed object such as a toothpick to push food particles into the spray arm jets.
- Rinse thoroughly under running water.
- Return the spray arms and check that they rotate freely.

## Cleaning the wash cabinet

Generally, the wash cabinet is self cleaning if the correct amount of dishwasher detergent is used.

The wash cabinet can be cleaned with a dishwasher cleaner such as Dis Cleaner available from your Miele dealer or the Miele Technical Service Department.

## Cleaning the door and door seal

- Wipe the door seal with a damp cloth to remove any food particles.
- Food residue and spilled liquids should be wiped from the sides of the dishwasher door. These are outside of the wash cabinet and are not cleaned by water from the spray arms.

## Cleaning the optic indicator reflector

The optic indicator reflector is located in the steam deflector under the countertop.

To clean the optic indicator reflector:

- Open the door and remove the reflector from the plastic mounting.
- Clean the reflector and the plastic mounting with a damp cloth.

 Do not use abrasive, glass or all purpose cleaners! These **will** damage the surface!

# Cleaning and Care

---

## Cleaning the control panel

- **Only** clean the control panel with a damp cloth.

 Do not use too much water when cleaning the controls. Water could penetrate into the electronics and cause damage.

 Do not use abrasive, glass or all purpose cleaners. They **will** damage the surface.

## Cleaning the exterior

 Never use abrasive cleaners, scouring pads, steel wool or caustic (oven) cleaners on the dishwasher. They **will** damage the surface.

### Plastic

All plastic surfaces can be cleaned with warm water and liquid dish soap applied with a soft sponge.

Wipe dry using a soft cloth.

### Stainless steel

Stainless steel surfaces can be cleaned using a non-abrasive stainless steel cleaner.

To help prevent resoiling, a conditioner for stainless steel can also be used. Apply sparingly with even pressure.

### Stainless steel colored controls

These controls can be cleaned with warm water and liquid dish soap.

These controls may become discolored or damaged if not cleaned regularly. Do not use a stainless steel cleaner on the knobs or buttons.

### Wood

Panels made from wood should be cleaned using a soft damp cloth and an appropriate wood cleaner.



## Cleaning the water inlet filter

A filter is incorporated in the intake hose attached to the dishwasher's shut off valve. If your water is hard, or the pipes contain sediment, this filter may clog and prevent enough water from entering the wash cabinet.

## Installing an in-line water filter

- If your water contains a large number of insoluble substances, a filter between the water valve and the intake hose connection is recommended. These filters can be purchased from Miele.

 The plastic valve housing on the intake hose contains electrical components and should not be submerged, or run through water.

## Cleaning the filter:

- Disconnect the dishwasher from electricity (unplug it or "trip" the circuit breaker).
- Turn off the water valve.
- Unscrew the intake hose.
- Carefully remove the rubber seal.

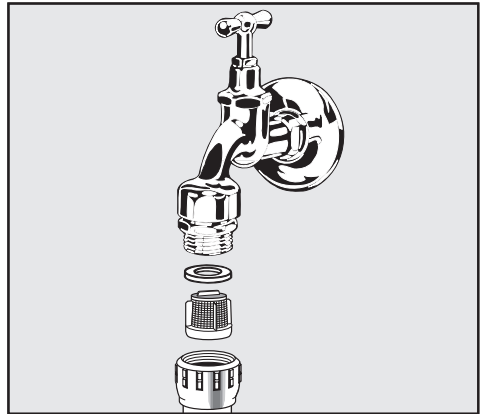

- Remove the filter using needle nose pliers and rinse under running water.
- Return the filter and seal. Make sure they are seated correctly.
- Screw the intake hose back on the water valve, checking that it is not cross-threaded.
- Slowly turn on the valve and test for leaks.

## Cleaning and Care

### Cleaning the drain pump and non-return valve

If the dishwasher is not completely drained at the end of a program, the drain pump or non-return valve may be blocked.

- Turn off the dishwasher.
- Remove the triple filter (see "Cleaning the filter in the wash cabinet").
- Use a jug or bowl to scoop water out of the wash cabinet.

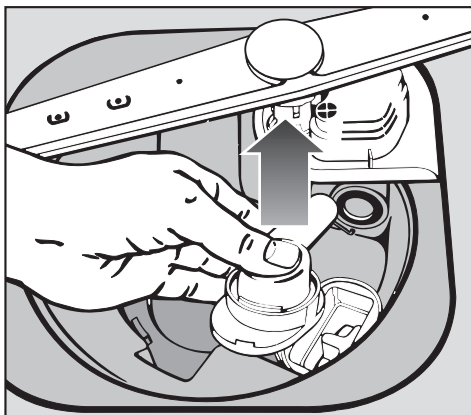

- Pull out the non-return valve and rinse well under running water.

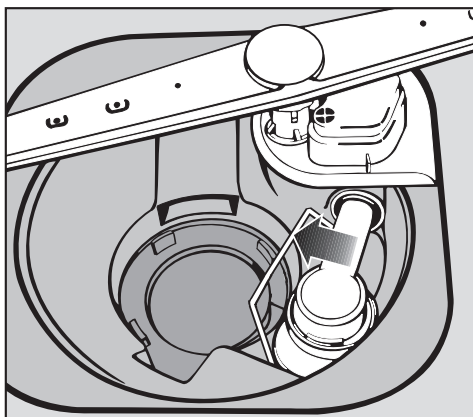

- Tilt the locking clamp to the side.

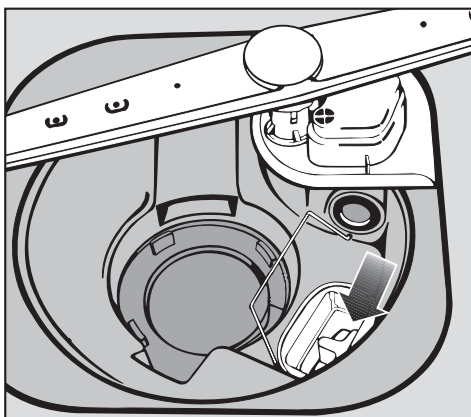

The drain pump is beneath the non-return valve (see arrow).

- Before returning the non-return valve, check that the drain pump is not blocked. Spin the propeller several times in both directions to check for obstructions.
- Carefully refit the non-return valve and secure it with the locking clamp.
- Refit and lock the filter in place.



When contacting the Technical Service,  
please quote the model and serial number  
of your appliance.

---



**Miele, Inc.** (USA)

**National Headquarters**

9 Independence Way

Princeton, NJ 08540

Phone: 800-843-7231

609-419-9898

Fax: 609-419-4298

[www.miele.com](http://www.miele.com)

**Technical Service & Support  
Nationwide**

Phone: 800-999-1360

Fax: 888-586-8056

**Miele Limited** (CDN)

**National Headquarters**

55G East Beaver Creek Road

Richmond Hill, ON L4B 1E5

Phone: 800-643-5381

905-707-1171

Fax: 905-707-0177

[www.miele.ca](http://www.miele.ca)

[info@miele.ca](mailto:info@miele.ca) (general enquiries)

[professional@miele.ca](mailto:professional@miele.ca) (commercial  
enquiries)

**Mielecare National Service**

Phone: 800-565-6435

905-850-7456

Fax: 905-850-6651

[service@miele.ca](mailto:service@miele.ca) (Tech. Service)