

Miele

Operating instructions

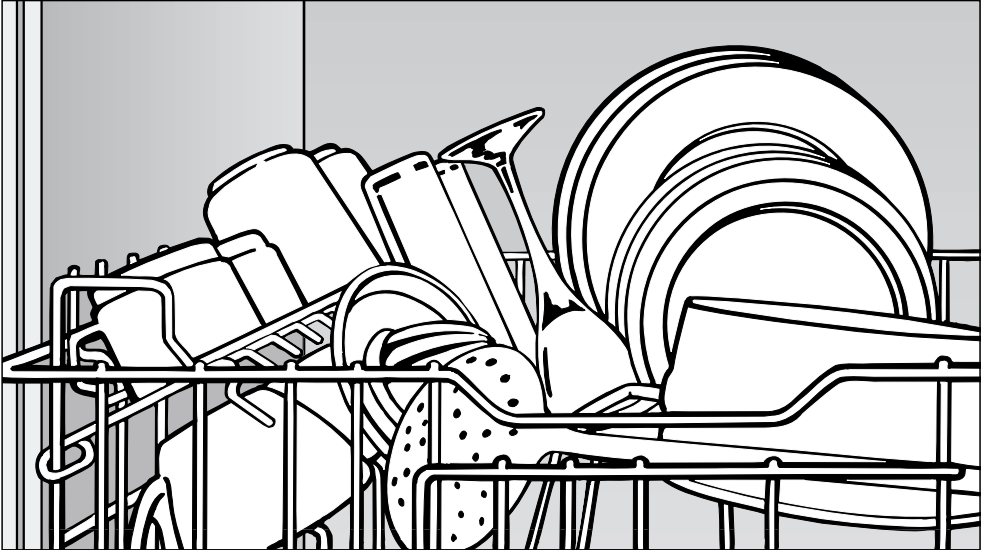

for G 803 dishwasher

To prevent accidents and machine damage read the Operating Instructions before installing or using the machine.

HG02



M.-Nr. 05 255 481

Contents

Guide to the appliance	4
View of the dishwasher	4
Control panel (11)	5
IMPORTANT SAFETY INSTRUCTIONS	6
INSTRUCTIONS IMPORTANTES SUR LA SÉCURITÉ	8
Caring for the environment	10
Disposing of the packing material	10
Disposing of an old machine	10
Energy saving washing	10
Before using for the first time	11
To open the door	12
To close the door	12
Water softener	13
Programming and setting the water hardness level	13
Programming the water hardness.	13
Setting the water hardness level selector in the wash cabinet.	18
Filling the salt reservoir.	19
Salt indicator.	20
Rinse aid	21
Adding rinse aid	21
Rinse aid indicator	22
Setting the dosage.	23
Loading the dishwasher	24
Loading examples	25
Upper basket	25
Adjusting the Upper basket	26
Lower basket	27
Cutlery tray	28
Items not suitable for dishwashers:	29

Operating the dishwasher	30
Adding detergent	30
Program selection	31
Turning on the dishwasher	32
Starting a program	32
End of a program	32
Turning off the dishwasher	32
Changing a program	33
Interrupting a program	33
Additional features	34
Heated drying	34
End of program buzzer	36
Unloading the dishwasher	38
Cleaning and care	39
Cleaning the filters in the wash cabinet	39
Cleaning the spray arms	41
Cleaning the wash cabinet	42
Cleaning the door and the door seal	42
Cleaning the control panel	42
Cleaning the door panel	42
Problem solving guide	43
Solving problems	48
Cleaning the water intake filter	48
Checking the water level	49
Increasing the water intake time	50
Cleaning the drain pump and non-return valve	52
After sales service	54
Special accessories	55
Transport	56
Technical data	57
Program chart	58

Guide to the appliance

View of the dishwasher

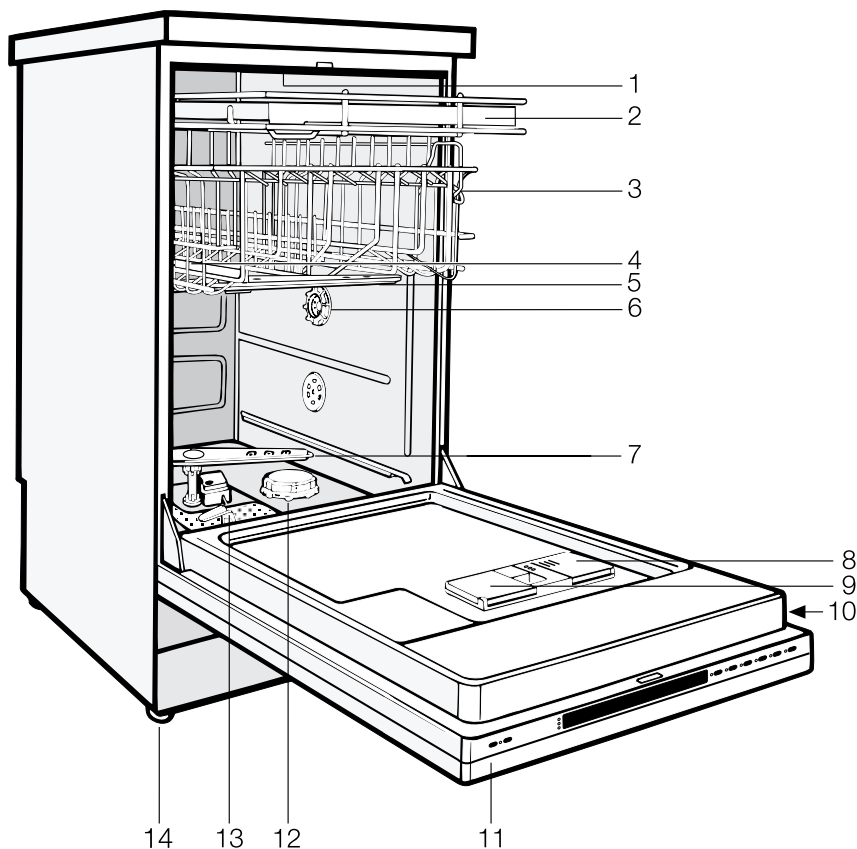

- | | |
|--|--|
| 1 Upper spray arm (not visible) | 9 Dual compartment detergent dispenser |
| 2 Cutlery tray (select models) | 10 Data plate |
| 3 Upper basket | 11 Control panel |
| 4 Water feed for middle spray arm | 12 Salt reservoir |
| 5 Middle spray arm | 13 Filter combination |
| 6 Water hardness selector | 14 Four height adjustable feet |
| 7 Lower spray arm | |
| 8 Rinse aid dispenser (with dosage selector) | |

Control panel (11)



15 “On” button

16 “Off” button

17 Check/Refill indicators

18 Program list

19 Program buttons

Please note:

The program list is covered by a protective film.

- Please pull this protective film off before using the appliance.

IMPORTANT SAFETY INSTRUCTIONS

WARNING

Please follow all basic safety precautions when operating this dishwasher.

This appliance conforms with all uniform safety codes and regulations. To avoid injury and machine damage, read the operating instructions carefully.

The manufacturer cannot be held responsible for damage or injury caused by improper use or for uses other than those for which the appliance is intended.

Repairs should only be performed by a qualified and competent person. Disconnect the appliance from the power supply before servicing (pull out the plug or “trip” the circuit breaker).

This dishwasher should only be installed under a continuous countertop secured to adjacent cabinetry.

The dishwasher must be electrically grounded. Install the dishwasher as outlined in the included Installation instructions.

Only use detergents and rinse aids recommended for residential dishwashers.

Do not use the dishwasher unless all panels are in place.

Do not allow children to play in or on the dishwasher.

Keep all detergents and rinse aids out of the reach of children.

Dishwasher detergents contain Sodium Silicate and Sodium Carbonate. In case of eye contact, immediately flush with water. Call a physician or poison control.

Do not tamper with the controls.

Do not drink water from the dishwasher.

IMPORTANT SAFETY INSTRUCTIONS

- When loading dishes and cutlery:
 - Place sharp items away from the door seal to prevent damaging the seal.
 - Load knives pointing down to prevent injuries.
- Do not wash plastic items unless they are labeled “dishwasher safe”. For items not labeled, check the manufacturer’s recommendations.
- Do not abuse, sit, or stand on the door or baskets of the dishwasher.
- Remove the front door and cut off the power cord of the dishwasher before disposing. This will help protect children from injury and accidentally locking themselves in.
- Under certain conditions, hydrogen gas may be produced in a hot water system that has not been used for two weeks or more. **HYDROGEN GAS IS EXPLOSIVE.** If the hot water system has not been used for such a period, turn on all hot water faucets and let the water flow from each for several minutes before using the dishwasher. This will release any accumulated hydrogen gas. Do not smoke or use an open flame during this time.

SAVE THESE INSTRUCTIONS

INSTRUCTIONS IMPORTANTES SUR LA SÉCURITÉ

AVERTISSEMENT

Au moment d'utiliser votre lave-vaisselle, veuillez observer toutes les mesures de sécurité de base.

Cet appareil électroménager est conforme à tous les règlements et codes sur la sécurité. Pour éviter de vous blesser et d'endommager l'appareil, veuillez lire soigneusement les instructions sur l'utilisation.

Le fabricant ne peut être tenu responsable des dommages ou blessures causés par une utilisation inadéquate ou par des utilisations autres que celles auxquelles l'appareil est destiné.

Les réparations doivent être effectuées uniquement par une personne compétente. Débrancher l'appareil de la prise de courant avant d'en faire l'entretien (enlever la fiche de la prise ou fermer le disjoncteur).

Installer uniquement ce lave-vaisselle sous un comptoir continu qui est fixé à des meubles adjacents.

Vous devez mettre le lave-vaisselle à la terre. Installer le lave-vaisselle en observant les instructions pour l'installation ci-jointes.

Utiliser uniquement des détergers et des produits de rinçage recommandés pour les lave-vaisselle domestiques.

Ne pas utiliser le lave-vaisselle à moins que tous les panneaux soient bien en place.

Ne pas permettre aux enfants de jouer dans ou sur le lave-vaisselle.

Ranger tous les détergers et produits de rinçage hors de la portée des enfants.

Les détergers pour lave-vaisselle contiennent du silicate de soude et du carbonate de soude. En cas de contact avec les yeux, les rincer immédiatement à grande eau. Téléphoner à un médecin ou à un centre de traitement antipoison.

Ne pas modifier les commandes.

Ne pas boire l'eau du meuble de lavage.

INSTRUCTIONS IMPORTANTES SUR LA SÉCURITÉ

■ Au moment de remplir le lave-vaisselle :

- Mettre les articles pointus de manière à ce qu'ils n'endommagent pas le seau étanche de la porte.
- Mettre le tranchant des couteaux vers le bas afin d'éviter les risques de blessure.

■ Ne pas laver les articles en plastique à moins qu'ils n'indiquent "Va au lave-vaisselle". Vérifier les recommandations du fabricant pour les articles non étiquetés.

■ Ne pas abuser et ne pas vous asseoir ni vous tenir sur la porte ou sur les paniers du lave-vaisselle.

■ Enlever la porte et couper le cordon du lave-vaisselle avant de l'enlever aux déchets afin d'empêcher les enfants de se blesser ou de s'enfermer dans l'appareil par accident.

■ Dans certaines conditions, un système d'eau chaude qui n'a pas été utilisé pendant plus de deux semaines, peut dégager de l'azote. L'AZOTE EST EXPLOSIF. Si le système d'eau chaude n'a pas été utilisé pendant une telle période de temps, ouvrir tous les robinets d'eau chaude et laisser l'eau couler pendant plusieurs minutes avant d'utiliser le lave-vaisselle. Ceci dissipera tout l'azote accumulé. Ne pas fumer ni utiliser une flamme nue durant ce temps.

CONSERVER CES INSTRUCTIONS.

Caring for the environment

Disposing of the packing material

The cardboard box and packing material protects the appliance during shipping. These materials are biodegradable and recyclable, please recycle.

Disposing of an old machine

Before disposing of an old appliance, please make child resistant as outlined in the “Important Safety Instructions” by removing power cords and doors.

Energy saving washing

This dishwasher is exceptionally economical in the use of water and electricity. For best results follow these tips:

The dishwasher can internally heat water to the temperatures required by the wash program. This capability allows the option of connecting the machine to either a hot or cold water source.

- For lowest energy consumption and the gentlest washing of china and crystal, connect the dishwasher to a cold water source.
- For fastest possible wash times, yet higher energy consumption, connect the dishwasher to a hot water source.
- For the most economical washing make full use of the baskets without overloading the dishwasher.
- Choose the program best suited for the type of dishware being washed and the degree of soiling.
- Select the Economy program for energy saving dishwashing.
- Use the correct amount of detergent.
- Use only 2/3 the usual amount of detergent when baskets are only half full.
- Turn off the heated drying feature to conserve more energy (see “Additional features”).

Before using for the first time

Before using for the first time, please note the following points.

Setting the water softener.

The water softener must be set to correspond to the water hardness in your area. This can be obtained from your local water company, or by using a test kit that can be purchased from the Miele Parts Department.

The salt reservoir must only be filled with water and salt. Never fill it with detergent.

Adding rinse aid.

Inadvertently filling the rinse aid reservoir with detergent will damage the reservoir.

Only use detergents and rinse aids formulated for domestic dishwashers.

Choose the correct program.

Different wash programs should be selected for different loads and different degrees of soiling. See the program chart for further program descriptions.

Add the correct amount of detergent.

Generally, 1 ½ tablespoons (25 ml) of detergent is enough for most wash loads. Not enough or too much detergent can lead to poor wash results.

Cleaning results vary among detergent brands. If you are not satisfied with the wash results, try another brand of detergent.

Load dishes correctly.

Load dishes so that water can reach all surfaces. Check that the spray arms are not blocked by items that are too tall for the baskets or hang through the bottom of the baskets. If necessary, manually rotate the spray arms to check clearance.

The combination filter in the base of the wash cabinet and the spray arms must be kept clean.

These should be regularly inspected and cleaned, if necessary.

See the corresponding sections for detailed information on the above points.

Every dishwasher is tested before leaving the factory. Any water remaining in the machine is from these tests and does not indicate that the machine has been used.

Before using for the first time

To open the door

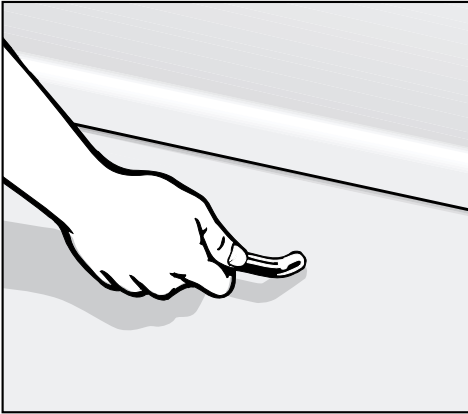

- Pull the handle.

If the door is opened during operation, the wash program is automatically interrupted.

Note:

Instructions on how to open the dishwasher if a door panel has not yet been installed can be found in Section 3 of the Installation Instructions; “Installing the custom door panel”

To close the door

- Push the baskets in.
- Lift the door and push until it clicks into position.

Water softener

For good cleaning results, the dishwasher needs to operate with soft water. Hard water results in the build up of calcium deposits on dishes and in the dishwasher.

If water hardness is above 4 gr/gal (70 ppm), the water should be softened. This takes place automatically in the integrated water softener.

- The water softener must be filled with dishwasher salt for reactivation.
- The dishwasher must be programmed to correspond to the water hardness in your area.
- Your water company can tell you the highest level of water hardness in your area.

If your tap water is consistently lower than 4 gr/gal (= 70 ppm) do not add dishwasher salt. However, the dishwasher must still be programmed to correspond to the water hardness in your area.

Where water hardness fluctuates e.g. between 8 - 17 gr/gal (140 - 310 ppm), always program the dishwasher to the higher value (in this example 17 gr/gal / 310 ppm)!

If there is a fault it will help the service technician to know the hardness of your tap water.

- Enter the water hardness below:

_____ gr/gal (ppm)

Programming and setting the water hardness level

The water hardness of your water supply must be programmed into the dishwasher using the buttons on the control panel.

The water hardness selector in the wash cabinet must also be set to the water hardness in your area.

Programming the water hardness

The programmed water hardness can be checked and adjusted using the buttons on the control panel. The indicators will light after each button is pressed (⊙) on the control panel.

While programming, the water hardness can be cancelled by turning off the dishwasher with the "Off" button.

The water hardness is preset to 1 - 5 gr/gal (20 - 90 ppm).

Before using for the first time

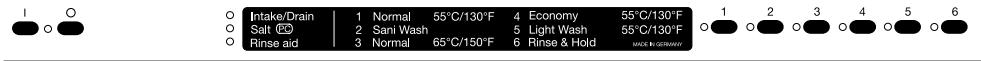

Procedure...



lights



flashes

■ Open the door.

■ Turn off the dishwasher using the “Off” (○) button.

■ Hold the buttons ① and ③ in and at the same time turn the dishwasher on with the “On” (I) button.

On

Salt

■ Release the buttons ① and ③.

On

Salt + ②

Note: If any other indicators **flash** the process must be repeated.

The following indicators will light, if:

- rinse aid was never added or needs to be refilled,
- Heated drying is deactivated (see “Additional features”),
- the water intake time has been increased (see “Increasing water intake time”),
- the end of program buzzer is deactivated (see “Additional features”).

Rinse aid

①

③

④

■ Press the ② button.

On

Salt

As the water hardness is programmed an additional indicator will also light.

- 1 - 5 gr/gal (20 - 90 ppm): ①
- 6 - 7 gr/gal (110 - 130 ppm): ②
- 8 gr/gal (140 ppm): ③
- 9 - 11 gr/gal (160 - 200 ppm): ④
- 12 - 14 gr/gal (220 - 250 ppm): ⑤

If the water hardness is programmed between 15 gr/gal and 70 gr/gal (270 -1260 ppm) an additional indicator will also light.

Before using for the first time

Procedure...



The correct water hardness is now programmed:

- Turn off the dishwasher with the “Off” (○) button.

To change the water hardness:

- Press the button that corresponds to the water hardness of your area. As long as the button is held in the indicator will remain lit.

1 - 5 gr/gal (20 - 90 ppm):	button ①	On + ①	Salt
6 - 7 gr/gal (110 - 130 ppm):	button ②	On + ②	Salt
8 gr/gal (140 ppm):	button ③	On + ③	Salt
9 - 11 gr/gal (160 - 200 ppm):	button ④	On + ④	Salt
12 - 14 gr/gal (220 - 250 ppm):	button ⑤	On + ⑤	Salt

15 - 70 gr/gal (270 -1260 ppm): see the following page

- Release the button. On Salt + ②

Other indicators may light depending on which features have been selected:

- Press ⑥ button. On + ⑥ Salt
- Press the ⑥ button once more. On Salt + ⑥
- Turn the dishwasher off with the “Off” (○) button.

The programmed water hardness level is now stored in the program memory.

- To check the setting of the water hardness selector (see “Setting the water hardness level in the wash cabinet”).

Before using for the first time



Procedure...

lights flashes

For water hardness levels greater than 14 gr/gal:

- Press the ⑥ button.

On+⑥

Salt

If the water hardness level is programmed between 15 gr/gal and 70 gr/gal, an additional indicator will light:

15 - 16 gr/gal (270 - 290 ppm):	①
17 - 21 gr/gal (310 - 380 ppm):	②
22 - 24 gr/gal (400 - 430 ppm):	③
25 - 31 gr/gal (450 - 560 ppm):	④
32 - 70 gr/gal (580 -1260 ppm):	⑤

The correct water hardness level is now programmed:

- Turn off the dishwasher with the “Off” (○) button.

To program a different water hardness level:

- Press the button that corresponds to the water hardness of your area. As long as the button is held in the indicator will remain lit.

15 - 16 gr/gal (270 - 290 ppm): button ①	On+⑥ + ①	Salt
17 - 21 gr/gal (310 - 380 ppm): button ②	On+⑥ + ②	Salt
22 - 24 gr/gal (400 - 430 ppm): button ③	On+⑥ + ③	Salt
25 - 31 gr/gal (450 - 560 ppm): button ④	On+⑥ + ④	Salt
32 - 70 gr/gal (580 -1260 ppm): button ⑤	On+⑥ + ⑤	Salt

- Release the button

On

Salt + ②

Other indicators may light depending on which features have been selected:

Before using for the first time

Procedure...

 lights

 flashes

■ Press the  button.

On + 

Salt

■ Press the  button once more.

On

Salt + 

■ Turn off the dishwasher with the “Off” () button.

The water hardness level is now saved in the program memory.

■ Check the setting of the water hardness level inside the wash cabinet and make any necessary adjustments (see “Setting the water hardness level in the wash cabinet”).

Before using for the first time

Setting the water hardness level selector in the wash cabinet

The water hardness level selector in the wash cabinet must be set according to the following table.

Selecting the correct setting will help minimize the effects of dishwashing on glass surfaces. Too high a setting will lead to poor cleaning results and an increase in water spots left on dishes and cutlery.

- Use a screwdriver to take the cover off the water hardness level selector in the wash cabinet.

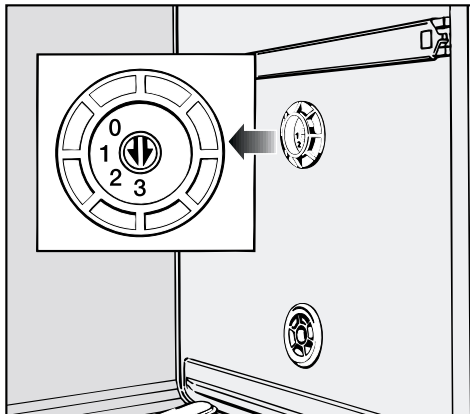

- Use a coin or screwdriver to adjust the water hardness level selector in the wash cabinet. There is a click as each setting is reached.

gr/gal	ppm	Selector setting
1 - 8	20 - 140	3
9 - 11	160 - 200	2
12 - 16	220 - 290	1
17 - 70	310 -1260	0

The water hardness selector is preset to setting 3.

Example:

For a water hardness 9 gr/gal.

The water hardness selector is set on 2 (9 - 11 gr/gal).

- Replace the cover on the water hardness level selector.

Before using for the first time

Filling the salt reservoir.

The salt reservoir should be filled before the first use and whenever the “Salt” indicator lights. Only use water softener reactivation salt (1 - 4 mm grain size), other salts may contain insoluble additives which can impair the water softener.

The salt reservoir holds approximately 2 lbs (1 kg) of salt.

Inadvertently filling the salt reservoir with dishwashing detergent will damage the water softener. Make sure that only water softener reactivation salt of the proper grain size is used.

To fill the salt reservoir:

- Remove the lower basket.
- Unscrew and remove the salt reservoir cap.

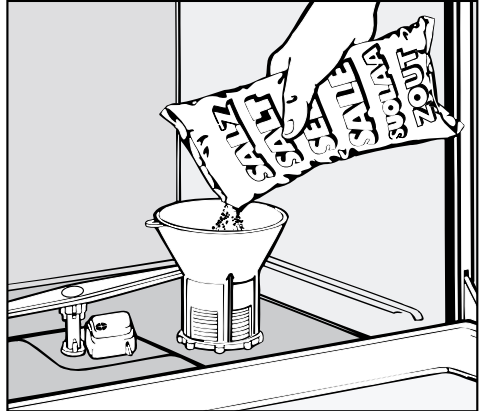

Before adding salt for the first time, fill the reservoir with approximately 1 quart (1 l) of water.

- Place the funnel provided over the salt reservoir.
- Carefully fill with salt. As it is filled, water will run out.
- Clean any excess salt from the threads of the reservoir opening.
- Screw the cap on firmly.

If the dishwasher will not be used immediately after reactivation, run the “Rinse & Hold” program. This will remove any traces of salt from inside the wash cabinet.

Before using for the first time

Salt indicator.

When the salt reservoir is empty, the “Salt-PC” indicator lights, indicating that it needs to be refilled with reactivation salt.

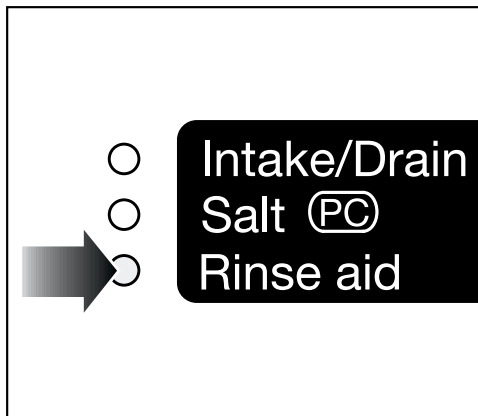

After the reservoir has been filled, the water softener is automatically reactivated the next time the dishwasher is started. The “Softener” indicator will light during this process.

Note:

If your water is very soft (below 4 gr/gal), the salt indicator light will stay on. The reservoir should not be filled with salt. The indicator will remain lit and should be disregarded or bypassed.

The “Salt-PC” indicator has also been designed so that future program updates can be entered into the dishwasher. See “After Sales Service”.

Bypassing the Salt indicator.

In order to bypass the salt indicator light, you will need a screwdriver and needle nose pliers.

- Remove the salt reservoir cap.

Looking into the salt reservoir, you will see the top of the float chamber on the right hand side ①.

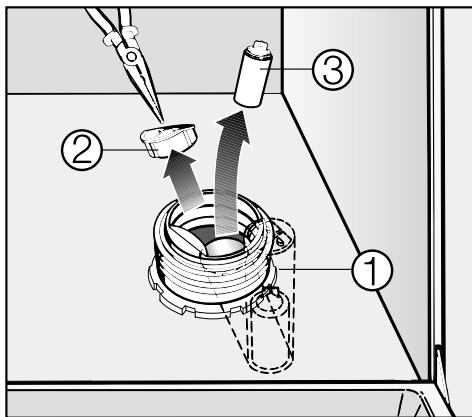

- Using a screwdriver, carefully pivot the float chamber towards the center of the reservoir.
- Using the needle nose pliers, pull the cap ② off of the float chamber, and remove the float ③.
- Replace the float chamber cap, push the chamber back into its upright position, and replace the salt reservoir cap. The indicator should not light.

Before using for the first time

Rinse aid

Rinse aid is recommended to prevent spotting on dishes and glassware that normally occurs during the drying cycle.

Inadvertently filling the rinse aid reservoir with detergent will damage the reservoir. Only pour rinse aid formulated for residential dishwashers into the reservoir.

Adding rinse aid

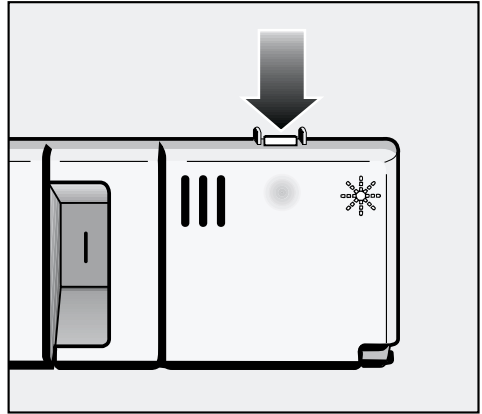

- Add Rinse aid before the first use and whenever the “Rinse Aid” indicator lights.
- Press the button in the direction of the arrow until the flap springs open.

Before using for the first time

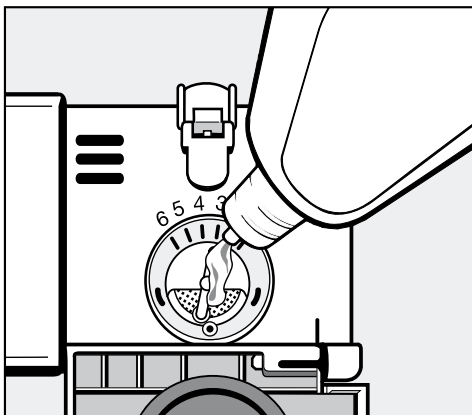

- Pour liquid rinse aid into the reservoir until it is visible on the surface of the screen. Do not refill until the “Rinse Aid” indicator lights.

Only use rinse aid labeled for residential dishwashers. Inadvertently adding detergent to the rinse aid dispenser will cause damage.

- Press on the flap until you hear it click shut. Failure to close it all the way will allow water to enter the reservoir during the wash program.
- Wipe up any spilled rinse aid.

The flap will remain closed during normal operation.

Rinse aid indicator

The rinse aid indicator on the control panel will light when the rinse aid reservoir needs refilling.

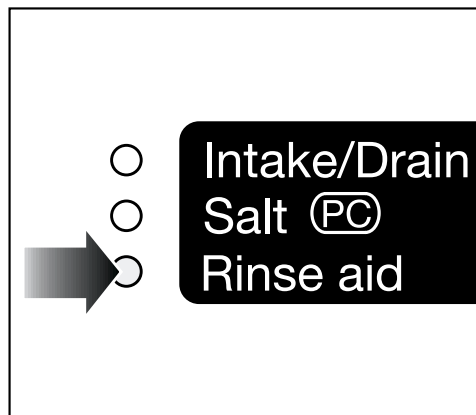

There will be enough rinse aid left for 2 - 3 washes after the indicator first lights.

Setting the dosage

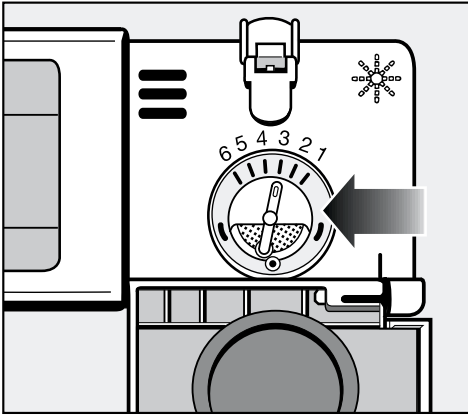

The dosage selector comes preset to 3. This dispenses approximately 3 ml of rinse aid per program. It can be adjusted from 1 to 6, depending on your needs.

- Use a higher setting if spots appear on dry glassware.
- Use a lower setting if streaking appears on dishes or glasses.

Loading the dishwasher

Do not wash items soiled with ash, wax, grease or paint in the dishwasher.

Ash does not dissolve and will be distributed through out the inside of the dishwasher. Wax, grease and paint will cause permanent discoloration or damage to the dishwasher.

- Scrape food from dishes before placing in the dishwasher but, do not rinse dishes.
- Load dishes so that water can reach all surfaces.
- Do not place dishes and cutlery inside other pieces where they may be hidden.
- Hollow items such as cups and glasses should be inverted and placed in the upper basket.
- Concave based items should be placed at an angle on top of the coffee bar, so that water does not pool.
- To ensure good water coverage tall, narrow, hollow pieces should be placed in the center of the basket, rather than in the corners.

- Small cups and glasses should be placed on the cup racks. Taller mugs and glasses can be placed underneath the rack.
- The spray arms must not be blocked by items that are too tall or hang through the baskets. Check clearance by manually rotating the spray arms.

Some food may contain natural dyes that can discolor plastics in the dishwasher (e.g. carrots, tomatoes, ketchup, etc.). The stability of plastic items are not affected by this discoloration.

Loading the dishwasher

Loading examples

Upper basket

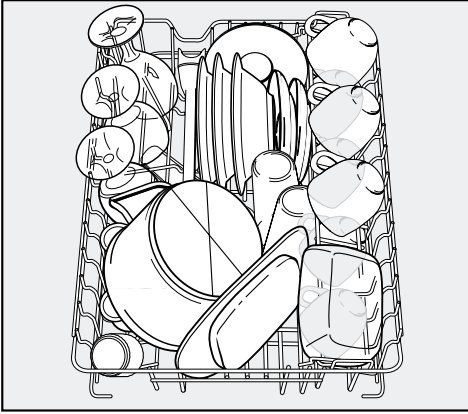

For small, light weight, or delicate items such as cups, saucers, glasses, and dessert bowls, as well as heat resistant plastics. Flat pans can also be placed in the upper basket.

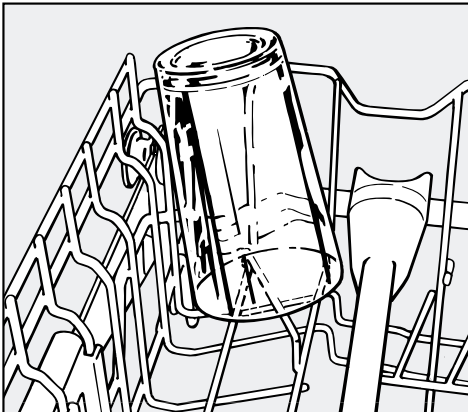

There are angled holders in the corners of the upper basket. These are made to support narrow glasses in the best position for a thorough cleaning.

Cup rack

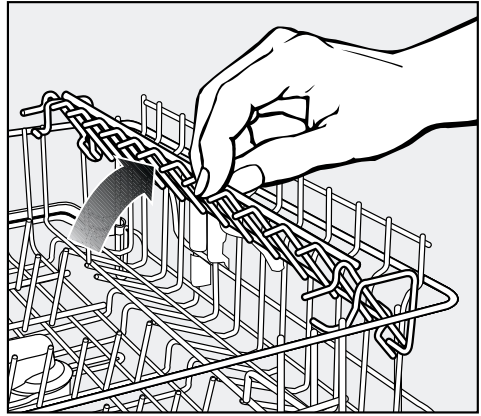

The adjustable cup rack can be raised to make room for taller items or lowered to double stack smaller items.

Loading the dishwasher

Adjusting the upper basket

The upper basket height is adjustable. If tall items are being washed, more room can be made by raising or lowering the upper basket.

Do not set the angle to the extreme - one side at the highest setting and one side at the lowest. This will block the middle spray arm.

- Slide out the upper basket.

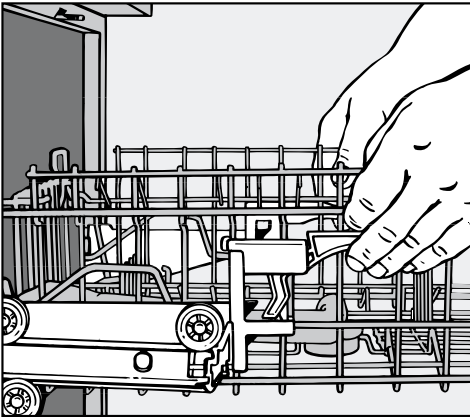

- Pull up the levers at the sides of the upper basket and adjust the basket height.
- Release the levers and the basket will lock in place.

Depending on the setting of the upper basket, the following plate dimensions can be accommodated.

Upper basket position	Plate diameter	
	Upper basket	Lower basket
Top	8" (20.5 cm)	12" (30 cm)
Middle	9" (22.5 cm)	11" (28 cm)
Bottom	10" (24.5 cm)	10" (26 cm)

Lower basket

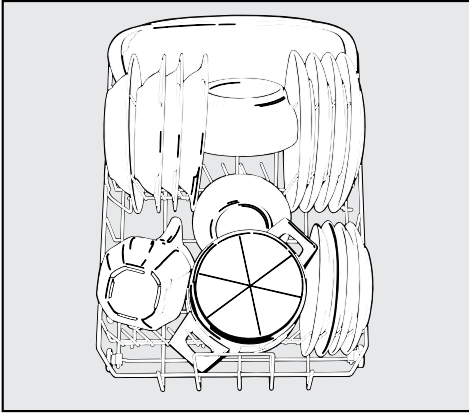

For larger and heavier item such as plates, serving platters, saucepans, bowls, etc. Small items like saucers can also be placed in the lower basket. Do not place thin , delicate glassware in the lower basket unless a special basket with glassware insert is installed.

Loading the dishwasher

Cutlery tray

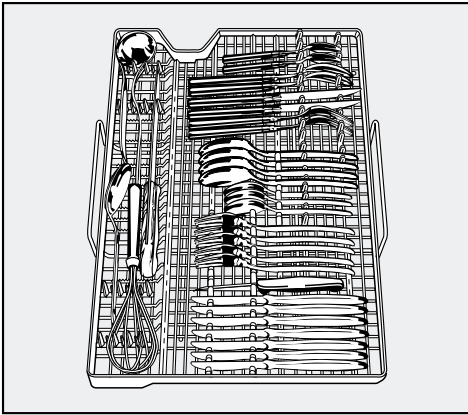

For best results cutlery should be grouped in zones, one for knives, one for forks, etc. making unloading easier.

Place the blades of knives and the tines of forks between the holders. Spoons should be placed in the opposite direction with the handle in the holder.

Longer items such as soup ladles, spatulas, mixing spoons and long knives should be placed lengthwise in the indentation in the middle of the cutlery tray.

The upper spray arm must not be blocked by large pieces.

The cutlery tray insert is removable.

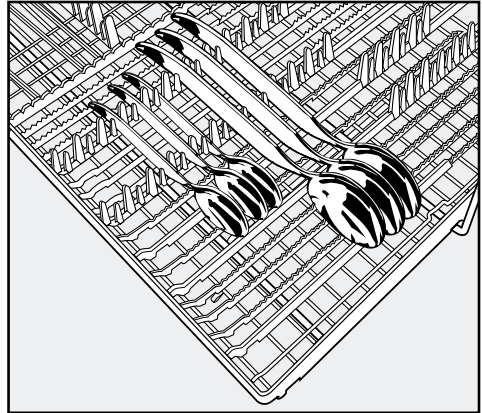

Spoon heads should be placed in contact with the serrated retainers of the cutlery tray so water can run off.

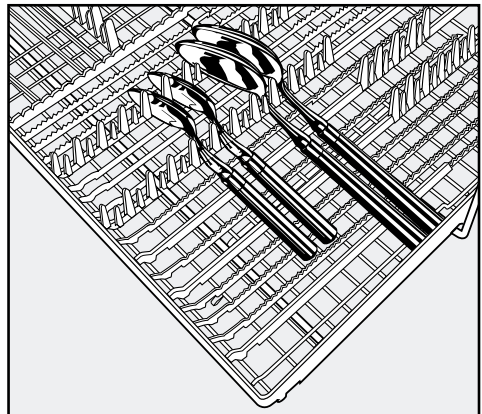

If a spoon handle does not fit securely between the holders then place it like the forks and knives.

Do not cover the opening in the middle of the cutlery tray. Make sure that the upper spray arm can rotate freely after the tray is slid in; otherwise the rotation of the spray arms may be inadequate for a thorough cleaning.

Loading the dishwasher

Items not suitable for dishwashers:

- Cutlery with wooden handles.
- Wooden cutting boards.
- Glued items such as old knives with handles that are glued together around the shank of the blade.
- Hand made craft items, antique or decorative glassware.
- Copper, brass or tin.
- Plastic items that are not heat resistant.

Please note:

- Silver or aluminum items may tarnish.
- Silverware previously cleaned with a silver polish may be damp or spotted at the end of a program where water has adhered to the polish. This can be rubbed off with a soft, dry cloth. Silver that has been cleaned in an immersion dip is usually dry at the end of a program, but may tarnish.
- Color painted over the glaze of dishes may fade over time.
- Clouding or etching may occur on glasses after frequent washing.

Miele recommends:

- Wash delicate glassware using the “Economy” program or the “China & Crystal” program to reduce the risk of clouding.
- There are no standard guidelines for washing glassware but, when in doubt wash by hand.
- When purchasing new dishes and cutlery, make sure they are dishwasher safe.
- If crystal or delicate glasses will be washed frequently, connect the dishwasher to cold, rather than hot water.

Operating the dishwasher

Adding detergent

Use only powdered detergents or tablets formulated for residential dishwashers. Do not use gels or liquid detergents.

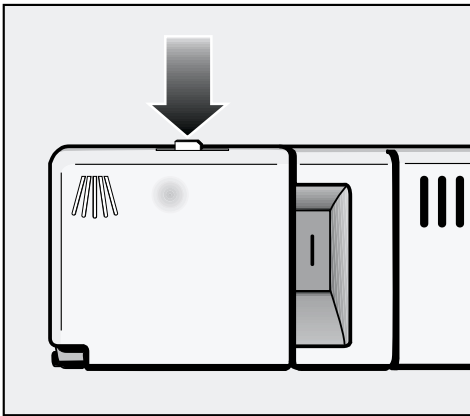

- Press the latch on the detergent dispenser. The cover will spring open.

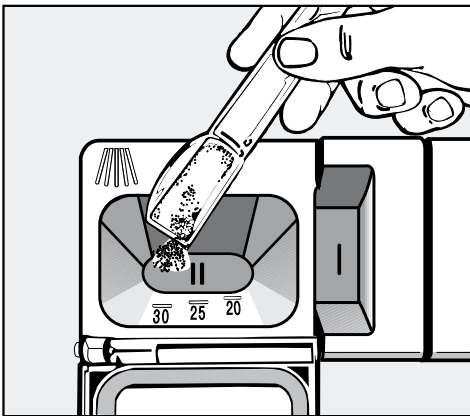

- Fill the dispenser with 1 ½ tablespoons (25 ml) of powder detergent, or place a detergent tablet into compartment II.

- Close the cover. The cover will always be open at the end of a wash program (except “Rinse & Hold”).

Generally, filling the dispenser with 1 ½ tablespoons (25 ml) of detergent is enough for a thorough cleaning. If dishes are extra dirty, or if food has dried on the dishes, a program containing a prewash cycle should be selected. Add an extra tablespoon (15 ml) of detergent to compartment I in the center of the dispenser, or place directly on the inner door panel.

Dishwasher detergents contain irritant and corrosive ingredients. They can cause burns in the mouth and throat if swallowed, or inhibit breathing. Keep children away from detergent and from the dishwasher when the door is open.

To prevent children from coming into contact with dishwasher detergent, do not fill the detergent dispenser until you are ready to run the dishwasher.

Capacities:

Compartment I (prewash) holds a maximum of ¾ ounce (20 ml) and Compartment II (main wash) holds a maximum of 2 ¾ ounces (70 ml) when completely filled. The horizontal marks in Compartment II indicate levels of approximately ¾, 1, and 1 ¼ ounces (20, 25 and 30 ml) respectively.

Program selection

The wash program chosen should depend on the type of dishes and the degree of soiling.

In most cases the “Light Wash”, the “Normal” or the “Sani Wash” program will give excellent results.

Available programs and their applications are listed in the Program Chart.

Operating the dishwasher

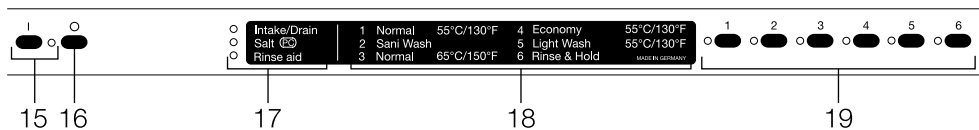

Turning on the dishwasher

- Open the water valve, if closed.
- Open the door.
- Check that spray arms are not blocked.
- Press the “On” button (15).

The “On” indicator lights.

Starting a program

- When selecting a program, refer to the Program Chart .
- Press the button for the desired program.

The indicator for the selected program will light.

- Close the door.

The program starts.

Do not end a program prematurely or important program steps (e.g. re-activating the water softener) could be omitted.

End of a program

The end of a program buzzer sounds when a program has finished.

The buzzer will sound every ten minutes.

Once the door is opened the buzzer will stop.

The end of program buzzer can be deactivated. (see “Additional features“).

Turning off the dishwasher

At the end of a program:

- Open the door a few inches (5 – 6 cm).

The program indicator goes out.

If the program indicator is still lit the program has not finished. Close the door so that the program may finish.

- Press the “Off” button (16).

The “On” indicator lights.

The dishwasher will continue to use electricity until it has been turned off.

Operating the dishwasher

The dishwasher can now be unloaded (see “Unloading the dishwasher”).

Be careful not to touch the heating elements. They can become extremely hot and cause serious burns!

The water valve should be closed if the dishwasher will not be used for a long period of time, (e.g. while on vacation).

Changing a program

If the door has not been closed after selecting a program:

- Simply press the button for the new program.
- Close the door.

The program will start.

If the program has already started and you wish to change the program:

- Open the door.
- Press the “Off” button (16).
- Press the “On” button (15).
- Press the selected program button.
- Close the door.

The program will start.

Interrupting a program

A program is interrupted as soon as the door is opened.

When the door is closed, the program will continue from the point it was at before the door was opened.

Warning!

Water in the dishwasher may be hot. There is a danger of being burned! Only open the door if absolutely necessary and with extreme caution. Before closing the door, leave ajar 20 seconds. This will allow the temperature in the wash cabinet to settle. Close the door firmly until it clicks into place

Be careful not to touch the heating elements. They can become extremely hot and cause burns!

Operating the dishwasher

Additional features



Heated drying

In all wash programs a heater element aids in drying. Heated drying is preset to be activated.

Dishes are then dried with residual heat. Open the dishwasher door a few inches at the end of a program to speed drying.

Activating and Deactivating Heated drying

Procedure...

lights flashes

- Open the door.
- Turn the dishwasher off with the “Off” (○) button.
- Press buttons ① and ③ simultaneously and at the same time turn the dishwasher on with the “On” (I) button.

On	Salt
----	------
- Release buttons ① and ③.

On	Salt + ②
----	----------

Note: If any other indicator light **is flashing**, the process must be repeated.

The following indicator lights may also **light**, if:

- rinse aid was never added or needs to be refilled. Rinse aid
- Heated drying has been deactivated ①
- the water intake time has been increased (see “Increase water intake time”) ③
- End of program buzzer is deactivated. ④

Operating the dishwasher

Procedure...

– Heated drying is activated, if:

 lights

 flashes

On
(+③,④)

Salt + ②

– Heated drying is deactivated, if:

On + ①
(+③,④)

Salt + ②

If the Heated drying setting is correct (activated or deactivated):

- Turn the dishwasher off by pressing the “Off” (○) button.

To change the Heated drying setting:

- Press button ①.

- Press button ⑥.

On + ⑥

Salt

- Press the ⑥ button again.

On

Salt + ⑥

- Turn off the dishwasher by pressing the “Off” (○) button.

The new Heated drying setting is now stored in the program memory.

Operating the dishwasher

Procedure...

 lights

 flashes

– the buzzer is activated, if:

On
(+①,③)

Salt + ②

– the buzzer is deactivated, if:

On + ④
(+①,③)

Salt + ②

If the buzzer setting is correct (activated or deactivated):

- Turn off the dishwasher by pressing the “Off” (○) button .

To change the buzzer setting:

- Press button ④.

- Press button ⑥.

On + ⑥

Salt

- Press button ⑥ again.

On

Salt + ⑥

- Turn off the dishwasher by pressing the “Off” (○) button.

The new buzzer setting is now stored in the program memory.

Operating the dishwasher

Unloading the dishwasher

- Dishes tend to break and chip more easily when hot. Let dishes cool until they are comfortable enough to handle before unloading.
- Dishes will cool much faster if the dishwasher door is opened a few inches after a program has finished.
- First unload the lower basket, then the upper basket and cutlery tray. This will prevent water drops from the upper basket and cutlery tray from falling on dishes in the lower basket.

Cleaning the filters in the wash cabinet

The combination filter in the base of the wash cabinet should be regularly inspected and cleaned, every 4 - 6 months. Any broken glass or dishware should be removed immediately.

Use caution when cleaning the filters, non-return valve or drain pump; glass or bone splinters may be caught in the bottom of the wash cabinet.

- Turn off the dishwasher.

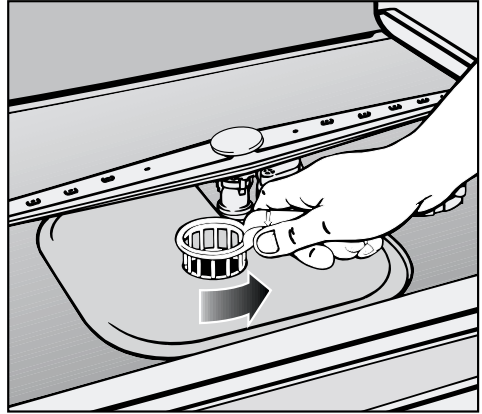

- Turn the handle counterclockwise to release the filters.

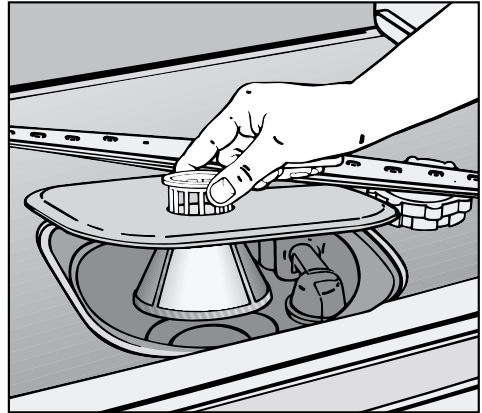

- Lift the combination filter out of the machine. Remove any coarse particles and rinse under running water. A nylon brush can be used.

Cleaning and care

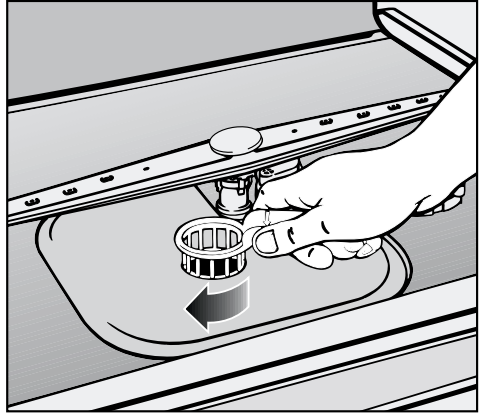
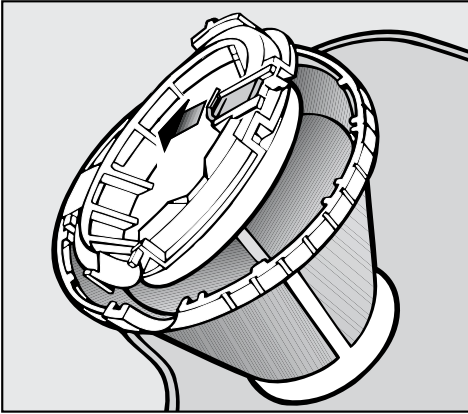

- Turn the combination filter over and open the coarse filter cover by pulling back on the locking tab.
- After cleaning, make sure that the coarse filter cover is properly locked in place.
- Return the combination filter so that it lies flat in the base of the dishwasher. Secure it by turning the handle clockwise.

Cleaning the spray arms

Sometimes particles of food get stuck in the spray arm jets. The spray arms should be inspected and cleaned every 4 - 6 months.

- Turn off the dishwasher.

Remove the spray arms as follows:

- Take out the cutlery tray.
- Press the top spray arm upwards to engage the inner ratchet and unscrew the spray arm.

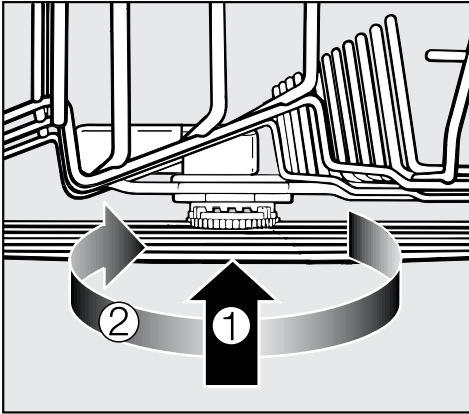

- Lift up the middle spray arm ①, to engage the ratchet and unscrew the spray arm ②.

- Remove the lower basket.

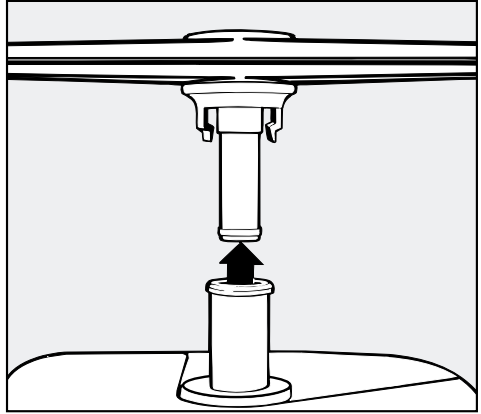

- Pull the lower spray arm firmly upwards to remove.

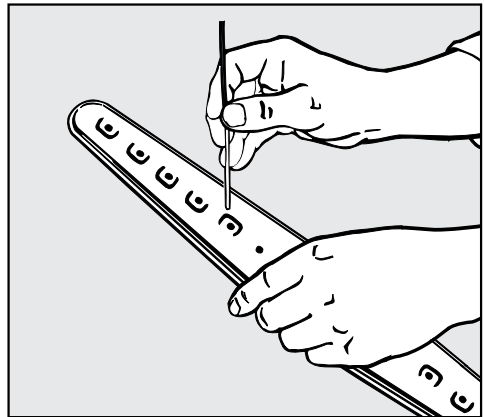

- Use a pointed object such as a toothpick to push food particles into the spray arm jets.
- Rinse thoroughly under running water.
- Return the spray arms and check that they rotate freely.

Cleaning and care

Cleaning the wash cabinet

Generally, the wash cabinet is self cleaning, provided the correct amount of dishwasher detergent is used.

If lime scale or grease deposits form, they can be removed with a special dishwasher cleaner.

Cleaning the door and the door seal

- Wipe the door seal with a damp cloth to remove any food particles.
- Food residue and spilt liquids should be wiped from the sides of the dishwasher door. The areas outside of the rubber seal are not cleaned by water from the spray arms.

Cleaning the control panel

- The control panel can be cleaned using a damp cloth and mild detergent.

Do not use abrasive, all purpose, or glass cleaners, they may damage plastic surfaces.

Cleaning the door panel

- Plastic laminate panels should be cleaned using a non-abrasive cleaner, or mild soapy water.
- Panels made from wood should be cleaned using a soft damp cloth and an appropriate wood cleaner.

Do not use any cleaning agents containing ammonia or petroleum distillates. They could damage surfaces.

Problem solving guide

With the aid of the following guide, minor problems can be corrected without a service call.

Any work required on the electrical components of the appliance should only be performed by a qualified and trained person in accordance with local and national regulations. Unauthorized repairs could be dangerous.

Problem	Possible cause	Remedy
The dishwasher does not start.	The door is not closed tightly.	Close the door completely.
	The machine is not plugged in.	Insert the plug.
	The circuit breaker is defective or has “tripped”.	Reset the circuit breaker.
	The dishwasher is not turned on.	Press the “On” button and select a program.
	A program has not been selected.	Press the desired program button.
Shortly after the program starts, the dishwasher stops.	The “Intake/Drain” light flashes. The water valve is closed.	Turn off the dishwasher, open the valve, and restart the program.
The dishwasher stops during a program.	The circuit breaker has “tripped”.	Reset the circuit breaker.

Problem solving guide

Problem	Possible cause	Remedy
The dishwasher stops during a program.	Not enough water is entering the machine. The “Intake/Drain” indicator flashes.	Before searching for the problem: Turn off the dishwasher. <ul style="list-style-type: none"> – Open the water valve completely. – Check the intake filter and clean it if necessary, see “Cleaning the intake filter”. – Check the water level and increase the intake time if necessary, see “Checking the water level”.
	Drainage is restricted - water is still inside the dishwasher at the end of a program. The “Intake/Drain” indicator flashes.	Before searching for the problem: Turn off the dishwasher. <ul style="list-style-type: none"> – Check for kinks in the drain hose. – Clean the drain pump and non-return valve, see “Cleaning the drain pump and non-return valve”. – Clean the combination filter, see “Cleaning the dishwasher filters”.
The indicator lights next to program buttons 1 to 5 flash.	A service call may be needed.	<ul style="list-style-type: none"> – Turn off the dishwasher and restart. If the indicators flash again: <ul style="list-style-type: none"> – Call the Miele Technical Service Department.

Problem solving guide

Problem	Possible cause	Remedy
Water remains in the dishwasher at the end of a program.		Before searching for the problem: Turn off the dishwasher.
	The drain hose is kinked.	Straighten the hose.
	The drain pump or non-return valve may be blocked.	Clean the drain pump and non-return valve, see "Cleaning the drain pump and non-return valve".
	The combination filter is clogged.	Clean the filter, see "Cleaning the dishwasher filters".
Rattling from within the dishwasher.	The dishes are moving inside the dishwasher.	Interrupt the program and rearrange the items not secured.
Knocking noise from within the dishwasher.	The spray arm is hitting something in the basket.	Interrupt the program and rearrange items obstructing the spray arms.
A whistling noise is heard during the program.	The circulation pump seal sometimes makes a whistling noise. This may be caused by detergent.	This is not a problem. Try other detergents. Call the Miele Technical Service Department if the noise is persistent.
Knocking noise in the water pipes.	This may be caused by the installation or the cross section of pipe.	This has no effect on dishwasher function. If in doubt contact a plumber.
The dishes are not clean.	The dishes were not loaded correctly. – Were the dishes placed inside of each other? – Could water reach all surfaces?	See "Loading the dishwasher".
	The water feed tube for the middle spray arm was covered.	Make sure that dishes placed at the rear of the upper basket do not cover the water feed tube.
	Not enough detergent was used.	Use more detergent; see "Adding detergent".

Problem solving guide

Problem	Possible cause	Remedy
The dishes are not clean.	The program selected was not strong enough.	Select a more intensive program; see the “Program chart” for guidelines.
	The spray arm jets are clogged.	Clean the spray arms, see “Cleaning the spray arms”.
	The combination filter inside the dishwasher is not clean or not inserted correctly.	Clean and/or reseal the filter, see “Cleaning the dishwasher filters”.
	The spray arms are blocked.	Rearrange dishes so that spray arms rotate freely.
	The drain pump or non-return valve may be blocked.	See “Cleaning the drain pump and non-return valve”.
	Too little water may be entering the dishwasher.	See “Checking the water level” and increase the water intake time if necessary.
Tea, coffee, or lipstick stains have not been completely removed.	The selected wash temperature was too low.	Select a program with a higher wash temperature.
	Old or non-chlorinated detergent was used.	Use fresh detergent containing chlorine.
Plastic items are stained.	Natural dyes from carrots, tomatoes or ketchup may stain plastics. The amount or type of detergent used was not strong enough to deal with these dyes.	Use an adequate amount of detergent containing chlorine. See “Adding detergent”.
There are smears on glasses and cutlery, or a bluish sheen on the surface of glasses. The film can be wiped off by hand.	The rinse aid dosage setting is too high.	Reduce the dosage. See “Adding rinse aid”.

Problem solving guide

Problem	Possible cause	Remedy
White residue is visible on cutlery and dishes, and clouding is evident on glasses; the residue can be wiped off.	Not enough rinse aid was dispensed.	See "Adding rinse aid" to increase the dosage.
	The salt reservoir is empty.	The "Salt - PC" indicator is lit. See "Filling the salt reservoir".
	The water softener is set too low.	Change to a higher setting; see "Before using the first time".
	The salt reservoir cap is not screwed on properly.	Screw the cap on firmly.
	Phosphate free detergent was used.	Try a detergent containing phosphates.
Glasses are dull and discolored and the film cannot be wiped off.	Glasses are not dishwasher safe.	This is permanent and cannot be reversed. Use glasses that are dishwasher safe.
The dishes are not dry or there is streaking on glassware and cutlery	Not enough rinse aid was dispensed or the rinse aid reservoir is empty.	Increase the dosage or add rinse aid; see "Adding rinse aid".
	The dishes were unloaded too soon.	Allow dishes to cool before unloading them; see "Unloading the dishes".
	Heated drying is turned off.	Turn on heated drying, see "Operating the dishwasher".
There are rust stains on cutlery.	The cutlery is not corrosion resistant or the surface of the cutlery is scratched or pitted.	There is no remedy. Always purchase dishwasher safe cutlery.
The detergent dispenser lid cannot be closed.	Detergent residue may be blocking the latch.	Clean out the residue.
Detergent remains in the dispenser at the end of a program.	The dispenser was damp when detergent was added.	Make sure the dispenser is dry before adding detergent.

Solving problems

Cleaning the water intake filter

A filter is incorporated in the intake hose attached to the dishwasher's shut-off valve. If your water is hard, or the pipes contain sediment; this filter may clog and prevent enough water from entering the wash cabinet. It can be cleaned as follows:

The plastic valve housing on the intake hose contains electrical components and should not be immersed, or run through water.

Cleaning the filter:

Disconnect the dishwasher from electricity (unplug it or "trip" the circuit breaker).

- Turn off the main shutoff valve and unscrew the intake hose.
- Carefully remove the rubber seal.
- Remove the filter using needle nose pliers and rinse under running water.

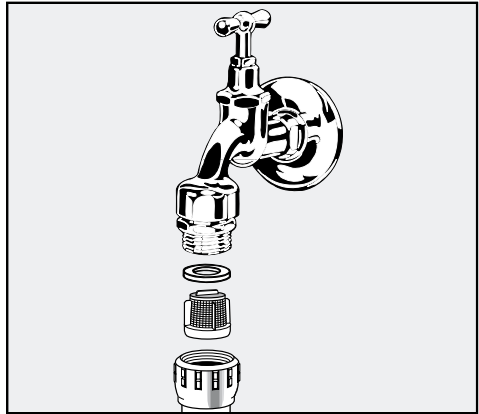

- Return the filter and seal. Make sure they are seated correctly.
- Screw the intake hose back on the water valve, checking that it is not cross-threaded.
- Slowly turn on the valve and test for leaks.

Installing an in-line water filter.

- If your water contains a large number of insoluble substances, a filter between the valve and the intake hose connection is recommended. These filters can be purchased from the Miele Parts Department.

Checking the water level

If the water pressure is less than 15 psi, too little water may flow into the wash cabinet.

- To check the water level, open the water valve completely and run the “Rinse & Hold” program once (without dishes), to bring water into the system.
- Run the “Rinse & Hold” program again. After approximately 3 minutes, open the door and remove the lower basket from the machine.

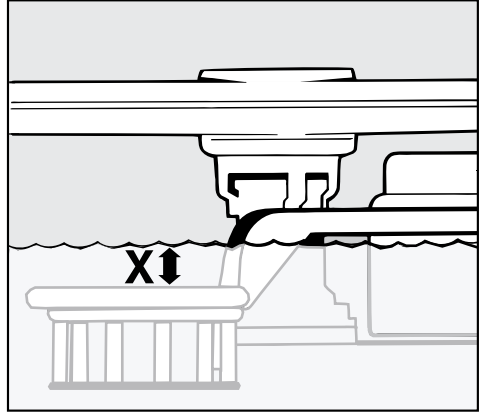

The water level is correct when dimension “X” is at least 1/8 ”(4 mm).

- If it measures less, the water intake time must be increased (see the following page).

Solving problems

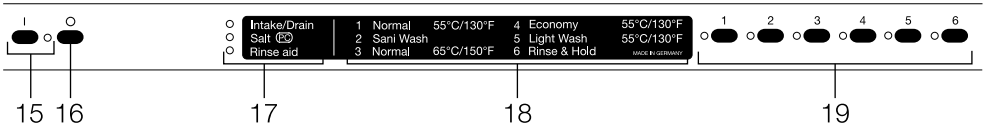

Increasing the water intake time

Procedure...

lights flashes

- Open the door.
- Turn off the dishwasher with the “Off” button (○).
- Press buttons ① and ③ while simultaneously turning on the dishwasher with the “On” button (|) .

On	Salt
----	------
- Release buttons ① and ③.

On	Salt + ②
----	----------

Note: If any other indicator lights **flash**, repeat the procedure from the beginning.

The following indicators may also be lit, if:

- Rinse aid has not been added or needs to be refilled,

Rinse aid

- Heated drying is deactivated (see “Additional features”)

①

- The water intake time has been increased (see “Increasing the water intake time”)

③

- The End of program buzzer is deactivated (see “Additional features”).

④

Procedure...

 lights

 flashes

Check the indicator lights to see if
“Increased time” is On or Off:

– Normal water intake time:	On (+ ^① , ^④)	Salt + ^②
– Increased water intake time:	On + ^③ (+ ^① , ^④)	Salt + ^②

To change the setting of the water intake time:

- Press button ^③. Salt + ^②
- To store your selection, press button ^⑥. On + ^⑥ Salt
- Press button ^⑥ once more. On Salt + ^⑥
- Turn off the dishwasher. The new setting is now stored in memory.

Indicator numbers in parentheses () may be lit depending upon features that have already been selected.

Solving problems

Cleaning the drain pump and non-return valve

Use caution when cleaning the filters, non-return valve or drain pump; glass or bone splinters may be caught in the bottom of the wash cabinet.

If the dishwasher is not completely drained at the end of a program, the drain pump or non-return valve may be blocked.

To clean them:

- Remove the combination filter.
- Use a jug or bowl to scoop water out of the wash cabinet.

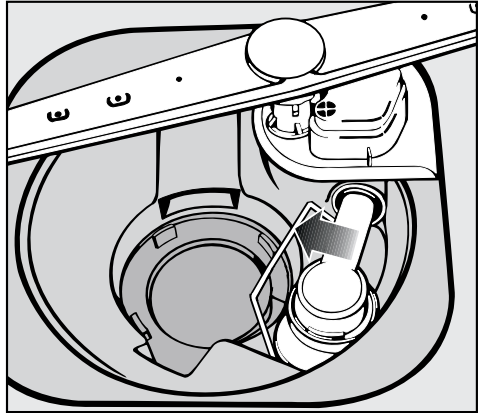

- Tilt the locking clamp to the side.

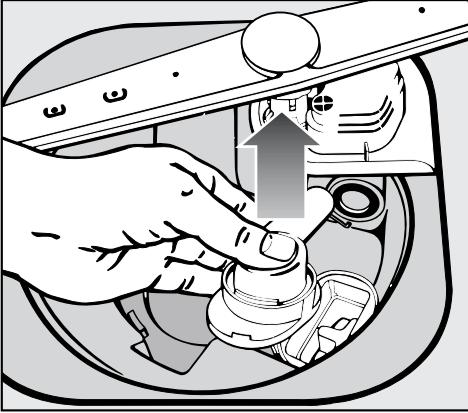

- Pull out the non-return valve.
- Rinse the non-return valve under running water.

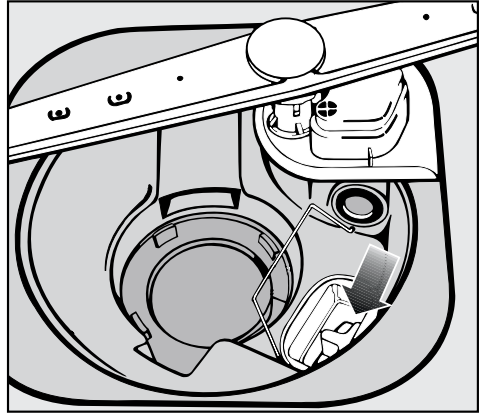

The drain pump is situated under the non-return valve (see arrow).

- Before returning the non-return valve, check to make sure that the drain pump is not obstructed. Spin the propeller several times in both directions; it should turn smoothly.
- Carefully refit the non-return valve and secure it with the locking clamp.
- Refit and secure the combination filter.

After sales service

If a problem can not be resolved, please contact the Miele Technical Service Department. (See back cover for telephone numbers).

Please have the model and serial number of your appliance available. This information can be found on the data plate on the upper edge of the dishwasher door.

Program update function - PC

The "PC" indicator has the function Program Correction (PC). This allows a technician to change the programming of the dishwasher to make use of new technological developments.

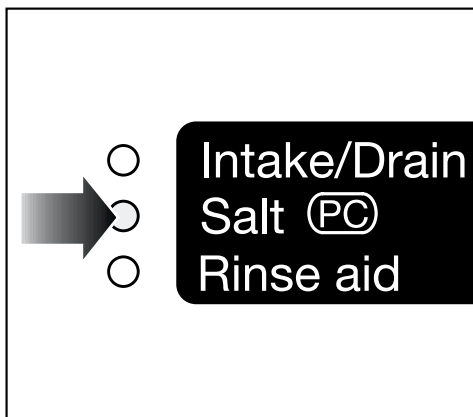

For instance, if a detergent becomes available that gives good wash results using only cold water, the wash programs can be modified to use only cold water.

The following special accessories are available for use with your dishwasher.

Glass insert for the bottom basket

provides the ability to safely wash glasses in the bottom basket. (Only available for models with removable inserts in the lower basket).

Glass insert for the upper basket

provides special support for long stemmed glassware.

These and other accessories are available through your Miele Dealer or the Miele Parts Department.

Transport

To transport the dishwasher, e.g. when moving to a new home, note the following:

- Empty the dishwasher,
- Secure any loose parts, e. g. hoses, cables, cutlery baskets.
- Transport the dishwasher in the upright position.

If unavoidable it may be transported on its back.

Do not transport it on its side or on the door because residual water in the machine will leak. This residual water could get into the electronic unit and cause damage.

Series designation HG02

Height	33 1/16" (84 cm [adj. + 2" /5.0 cm])
Width	17 1/2" (44.8 cm)
Width of cabinet opening	17 3/4" (45 cm)
Depth	22 7/16" (57 cm)
Depth with door open	47 7/16" (120.5 cm)
Weight	Approx. 108 lbs/49 kg
Voltage	110/120 V AC
Rated load	12.5 A / 1500 W
Fuse rating	15 A
Water pressure	15 - 150 psi
Water connection	max. 140 °F (60 °C)
Drain height	max. 39" (1 m)
Drainage length	max. 13" (4 m)
Connection cable	approx. 66" (1.7 m)
Capacity	9 complete place settings

Program chart

Program	When to use	Detergent		
		chlorine free ¹⁾	containing chlorine ²⁾	
		Compartment II (Wash cycle)	Compartment I (Pre-wash)	Compartment II (Wash cycle)
Normal ³⁾ 55 °C/130 °F	for normal everyday loads	100 %	20 %	80 %
Sani Wash	as Normal 55 °C/130 °F, but with longer wash time for heavily soiled tableware, also suitable for chlorine free detergents	100 %	20 %	80 %
Normal 65 °C/150 °F	as Normal 55 °C/130 °F, but at a higher temperature for stubborn dried on food	100%	20 %	80 %
Light Wash 55 °C/130 °F	for normal everyday loads, particularly suitable for chlorine free detergents	100 %		100 %
Economy 55 °C/115 °F	for normal everyday loads, particularly energy saving program	100 %		100 %
Rinse & Hold	For rinsing dishes when a complete cycle is not needed.			

The dispensing method will depend on the type of detergent being used.

1) Use this ratio for:

- detergent which is chlorine and phosphate free
- detergent which is chlorine free but contains phosphates

In this instance the whole amount is placed in compartment II.

2) Use this ratio for:

- powder detergent which contains chlorine and phosphates

Divide the total amount, as shown, between compartment I and compartment II.

When washing a full load in the Normal program, the Sani Wash program, the Light Wash program or the Economy program at least 1 ½ tablespoons (25 ml) of detergent are needed. If the detergent manufacturer recommends using more than this you should dispense the amount they suggest.

Program chart

Program cycle						Usage			Duration	
						Electric (kWh)		Water	Minutes (approx.)	
1. Preliminary pre-wash	2. Pre-wash	Main wash	Interim rinse	Final rinse	Drying	Cold water connection (10 °C/ 50 °F)	Hot water connection (49 °C/ 120 °F)	Liters/ Gallons	Cold water connection (10 °C/ 50 °F)	Hot water connection (49 °C/ 120 °F)
X	X	X 55 °C/ 130°F	X	X 65 °C/ 150°F	X	1.56	0.8	21 / 5.5	143	106
	X	X 65 °C/ 150°F	X	X 75 °C/ 170°F	X	2.4	1.42	17 / 4.5	182	143
X	X	X 65 °C/ 150°F	X	X 65 °C/ 150°F	X	1.74	1.0	21 / 5.5	150	106
		X 55 °C/ 130°F	X	X 65 °C/ 150°F	X	1.56	1.0	13 / 3.4	122	103
		X 55 °C/ 130°F	X	X 55 °C/ 130°F	X	1.35	0.65	13 / 3.4	112	84
	X					0.06	0.65	5 / 1.3	11	11

3) Standard program for comparison tests



Miele, Inc.

National Headquarters

9 Independence Way,
Princeton, NJ 08540
Phone: 800-843-7231
609-419-9898
Fax: 609-419-1435
Technical Service: 800-999-1360
www.mieleusa.com

Southeast Regional Headquarters

6400 Congress Avenue
Suite 1700
Boca Raton, FL 33487
Phone: 561-995-8030
Fax: 561-995-8083

West Coast Regional Headquarters

680 Eighth Street
Suite 168 - Sobel Building
San Francisco, CA 94103
Phone: 800-245-8215
415-241-6820
Fax: 415-241-6822

WEST COAST REGIONAL SERVICE 800-245-8215

Southern California Showroom

189 North Robertson Blvd.
Beverly Hills, CA 90211
Phone: 310-855-9470
Fax: 310-358-0238

Mid West Regional Headquarters

3100 West Dundee Road
Suite 901
Northbrook, IL 60062
Phone: 847-714-9433
Fax: 847-714-9434

Miele Limited

Canadian Head Office

55G East Beaver Creek Road
Richmond Hill
Ontario L4B 1E5
Phone: 905-707-1171
Toll-Free: 1-800-565-6435
Fax: 905-707-0177

Internet: www.miele.ca

E-Mail: info@miele.ca
(general enquiries)

E-Mail: service@miele.ca
(technical service)

BC Regional Sales Office

3731 North Fraser Way
Unit 200
Burnaby
British Columbia V5J 5J2
Phone: 604-434-1300
Fax: 604-434-1309

Quebec Regional Sales Office

400 Laurier Avenue West
Suite 600
Montreal
Quebec H2V 2K7
Phone: 514-277-1818
Toll-Free: 1-877-636-4353
Fax: 514-277-1838