

Panasonic®

Operating Instructions

Expandable Digital Corded/Cordless
Answering System

Model No. **KX-TG1061**

with 2 Handsets

Model No. **KX-TG1062**

with 3 Handsets

Model No. **KX-TG1063**

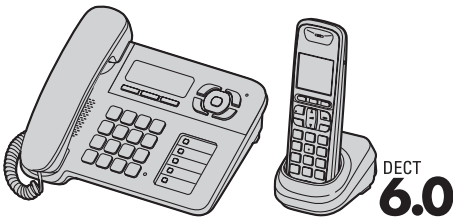

Model shown is KX-TG1061.

Panasonic's environmental declaration labels
This mark is an environmental label
showing that the products are certified
as Panasonic's Green Products.



Standby power consumption
reduced by 56%

Standby power consumption 1.3 W
Compared to the 2002 model KX-TG2584 (3.0 W)

Thank you for purchasing a Panasonic product.

This unit is compatible with Caller ID. You must subscribe to the appropriate service offered by your service provider/telephone company.

Charge the batteries for about 7 hours before initial use.

Please read these operating instructions before using the unit and save them for future reference.

For assistance, visit our website:

<http://www.panasonic.com/help> for customers in the U.S.A. or Puerto Rico.

Consulte "Guía Rápida Española", página 48.

Table of Contents

Introduction

Model composition	3
Accessory information	3

Important Information

For your safety	5
Important safety instructions	6
For best performance	6
Specifications	6
Other information	7

Getting started

Setting up	8
Note when setting up	9
Controls	10
Display	11
Initial settings	12

Making/Answering Calls

Making calls	13
Answering calls	14
Useful features during a call	14

Phonebook

Base unit/handset phonebook	16
Speed dial	18
Copying phonebook entries	19

Programming

Programmable settings	20
Special programming	25
Registering a unit	27

Caller ID Service

Using Caller ID service	28
Caller list	28

Answering System

Answering system	31
Turning the answering system on/off	31
Greeting message	31
Listening to messages using the base unit	32
Listening to messages using the handset	33
Remote operation	34
Answering system settings	35

Voice Mail Service

Voice mail service	37
------------------------------	----

Intercom/Locator

Intercom	38
Handset locator	38
Transferring calls, conference calls	38

Useful Information

Wall mounting	40
Belt clip	40
Error messages	41
Troubleshooting	42
FCC and other information	46

Guía Rápida Española

Guía Rápida Española	48
--------------------------------	----

Appendix

Customer services	56
Warranty (For United States and Puerto Rico)	57

Index

Index	59
-----------------	----

Model composition

Series	Model No.	Base unit	Handset	
		Part No.	Part No.	Quantity
KX-TG1061 series	KX-TG1061 ^{*1}	KX-TG1061	KX-TGA106	1
	KX-TG1062	KX-TG1061	KX-TGA106	2
	KX-TG1063	KX-TG1061	KX-TGA106	3

*1 Feature differences: Intercom calls can be made between the handsets by purchasing and registering one or more optional handsets (page 4).

Accessory information

Supplied accessories

No.	Accessory item/Order number	Quantity		
		KX-TG1061	KX-TG1062	KX-TG1063
①	AC adaptor/PQLV219Z	2	3	4
②	Telephone line cord/PQJA10075Z	1	1	1
③	Wall mounting adaptor/PNKL10035Z1	1	1	1
④	Corded handset/PNLXP1006Z	1	1	1
⑤	Corded handset cord/PQJA212V	1	1	1
⑥	Rechargeable batteries/HHR-4DPA (Part No. HHR-55AAABU or N4DHYYY00004)	2	4	6
⑦	Handset cover ^{*1} /PNYNTGA641TR	1	2	3
⑧	Belt clip/PNKE1029Z1	1	2	3
⑨	Charger/PNWETG6412M	1	2	3

*1 The handset cover comes attached to the handset.

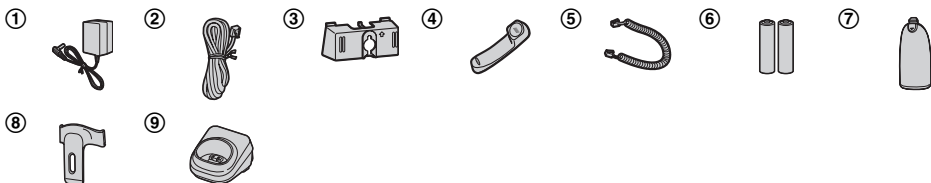

Additional/replacement accessories

Please contact your nearest Panasonic dealer for sales information (page 56).

Accessory item	Order number
Rechargeable batteries	HHR-4DPA*1 • To order, please call 1-800-332-5368 or visit http://www.panasonic.com/batterystore
	Battery requirement: – Nickel metal hydride (Ni-MH) type battery – 2 AAA (R03) batteries for each of every handsets
Headset	KX-TCA60, KX-TCA86, KX-TCA92, KX-TCA93, KX-TCA94
T-adaptor	KX-J66

*1 Replacement batteries may have a different capacity from that of the supplied batteries.

Expanding your phone system

You can expand your phone system by registering optional handsets (6 max.) to a single base unit.

Handset (optional): KX-TGA106



For your safety

To prevent severe injury and loss of life/property, read this section carefully before using the product to ensure proper and safe operation of your product.

WARNING

Power connection

- Use only the power source marked on the product.
- Do not overload power outlets and extension cords. This can result in the risk of fire or electric shock.
- Completely insert the AC adaptor/power plug into the power outlet. Failure to do so may cause electric shock and/or excessive heat resulting in a fire.
- Regularly remove any dust, etc. from the AC adaptor/power plug by pulling it from the power outlet, then wiping with a dry cloth. Accumulated dust may cause an insulation defect from moisture, etc. resulting in a fire.
- Unplug the product from power outlets if it emits smoke, an abnormal smell, or makes an unusual noise. These conditions can cause fire or electric shock. Confirm that smoke has stopped emitting and contact the Panasonic Call Center at 1-800-211-PANA (1-800-211-7262).
- Unplug from power outlets and never touch the inside of the product if its casing has been broken open.
- Never touch the plug with wet hands. Danger of electric shock exists.

Installation

- To prevent the risk of fire or electrical shock, do not expose the product to rain or any type of moisture.
- Do not place or use this product near automatically controlled devices such as automatic doors and fire alarms. Radio waves emitted from this product may cause such devices to malfunction resulting in an accident.
- Do not allow the AC adaptor or telephone line cord to be excessively pulled, bent or placed under heavy objects.

Operating safeguards

- Unplug the product from power outlets before cleaning. Do not use liquid or aerosol cleaners.
- Do not disassemble the product.
- Do not spill liquids (detergents, cleansers, etc.) onto the telephone line cord plug, or allow it to become wet at all. This may cause a fire. If the telephone line cord plug becomes wet, immediately pull it from the telephone wall jack, and do not use.
- Do not excessively pull the corded handset cord from the base unit. This may cause the base unit to fall, resulting in injury.

Medical

- Consult the manufacturer of any personal medical devices, such as pacemakers or hearing aids, to

determine if they are adequately shielded from external RF (radio frequency) energy. (The product operates in the frequency range of 1.92 GHz to 1.93 GHz, and the RF transmission power is 115 mW (max.).)

- Do not use the product in health care facilities if any regulations posted in the area instruct you not to do so. Hospitals or health care facilities may be using equipment that could be sensitive to external RF energy.

CAUTION

Installation and relocation

- Never install telephone wiring during an electrical storm.
- Never install telephone line jacks in wet locations unless the jack is specifically designed for wet locations.
- Never touch uninsulated telephone wires or terminals unless the telephone line has been disconnected at the network interface.
- Use caution when installing or modifying telephone lines.
- The AC adaptor is used as the main disconnect device. Ensure that the AC outlet is installed near the product and is easily accessible.
- The cordless handset is unable to make calls when:
 - the handset batteries need recharging or have failed.
 - there is a power failure.

Battery

- We recommend using the batteries noted on page 4. **USE ONLY rechargeable Ni-MH batteries AAA (R03) size.**
- Do not mix old and new batteries.
- Do not open or mutilate the batteries. Released electrolyte from the batteries is corrosive and may cause burns or injury to the eyes or skin. The electrolyte is toxic and may be harmful if swallowed.
- Exercise care when handling the batteries. Do not allow conductive materials such as rings, bracelets, or keys to touch the batteries, otherwise a short circuit may cause the batteries and/or the conductive material to overheat and cause burns.
- Charge the batteries provided with or identified for use with this product only, in accordance with the instructions and limitations specified in this manual.
- Only use a compatible charger to charge the batteries. Do not tamper with the charger. Failure to follow these instructions may cause the batteries to swell or explode.

Important Information

Attention:



A nickel metal hydride battery that is recyclable powers the product you have purchased. Please call 1-800-8-BATTERY (1-800-822-8837) for information on how to recycle this battery.

Important safety instructions

When using your product, basic safety precautions should always be followed to reduce the risk of fire, electric shock, and injury to persons, including the following:

1. Do not use this product near water for example, near a bathtub, washbowl, kitchen sink, or laundry tub, in a wet basement or near a swimming pool.
2. Avoid using a telephone (other than a cordless type) during an electrical storm. There may be a remote risk of electric shock from lightning.
3. Do not use the telephone to report a gas leak in the vicinity of the leak.
4. Use only the power cord and batteries indicated in this manual. Do not dispose of batteries in a fire. They may explode. Check with local codes for possible special disposal instructions.

SAVE THESE INSTRUCTIONS

For best performance

Base unit location/avoiding noise

The base unit and other compatible Panasonic units use radio waves to communicate with each other.

- For maximum coverage and noise-free communications, place your base unit:
 - at a convenient, high, and central location with no obstructions between the cordless handset and base unit in an indoor environment.
 - away from electronic appliances such as TVs, radios, personal computers, wireless devices, or other phones.
 - facing away from radio frequency transmitters, such as external antennas of mobile phone cell stations. (Avoid putting the base unit on a bay window or near a window.)
- Coverage and voice quality depends on the local environmental conditions.
- If the reception for a base unit location is not satisfactory, move the base unit to another location for better reception.

Environment

- Keep the product away from electrical noise generating devices, such as fluorescent lamps and motors.
- The product should be kept free from excessive smoke, dust, high temperature, and vibration.
- The product should not be exposed to direct sunlight.
- Do not place heavy objects on top of the product.
- When you leave the product unused for a long period of time, unplug the product from the power outlet.
- The product should be kept away from heat sources such as heaters, kitchen stoves, etc. It should not be placed in rooms where the temperature is less than 0 °C (32 °F) or greater than 40 °C (104 °F). Damp basements should also be avoided.
- The maximum calling distance may be shortened when the product is used in the following places: Near obstacles such as hills, tunnels, underground, near metal objects such as wire fences, etc.
- Operating the product near electrical appliances may cause interference. Move away from the electrical appliances.

Routine care

- **Wipe the outer surface of the product with a soft moist cloth.**
- Do not use benzine, thinner, or any abrasive powder.

Notice for product disposal, transfer, or return

- This product can store your private/confidential information. To protect your privacy/confidentiality, we recommend that you erase information such as phonebook or caller list entries from the memory before you dispose of, transfer, or return the product.

Specifications

- **Standard:**
DECT 6.0 (Digital Enhanced Cordless Telecommunications 6.0)
- **Frequency range:**
1.92 GHz to 1.93 GHz
- **RF transmission power:**
115 mW (max.)
- **Power source:**
120 V AC, 60 Hz
- **Power consumption:**
Base unit:
Standby: Approx. 1.3 W
Maximum: Approx. 2.0 W
Charger:
Standby: Approx. 0.1 W
Maximum: Approx. 3.3 W
- **Operating conditions:**
0 °C – 40 °C (32 °F – 104 °F), 20 % – 80 % relative air humidity (dry)

Note:

- Design and specifications are subject to change without notice.
- The illustrations in these instructions may vary slightly from the actual product.

Other information

CAUTION: Risk of explosion if battery is replaced by an incorrect type. Dispose of used batteries according to the instructions.

Notice

- This product is designed for use in the United States of America. Sale or use of this product in other countries may violate local laws.
- Cet appareil est conçu pour être utilisé aux États-Unis d'Amérique. La vente ou l'emploi de cet appareil dans certains autres pays peut constituer une infraction à la législation locale.
- Este producto está diseñado para usarse en los Estados Unidos de América. La venta o el empleo de este producto en ciertos países puede constituir violación de la legislación local.
- 本產品專為美國使用而設。若在其他國家銷售或使用，可能會違反當地法例。
- この製品は、日本国外での使用を目的として設計されており、日本国内での使用は法律違反となります。従って、当社では日本国内においては原則として修理などのサービスは致しかねます。

Setting up

Connections

- Use only the supplied Panasonic AC adaptor PQLV219.

■ Base unit

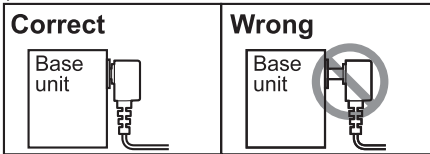
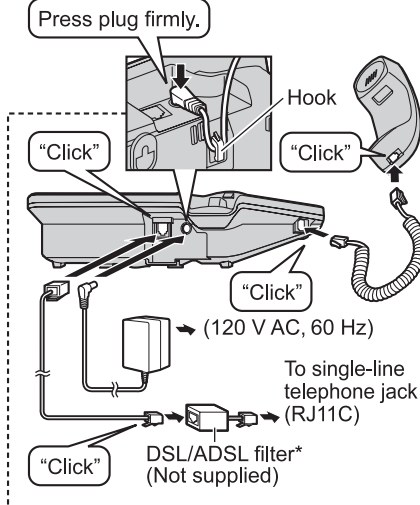

*For DSL/ADSL service users

■ Charger

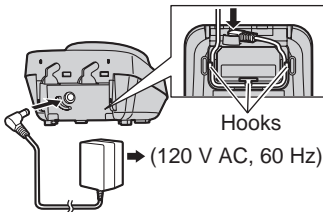

Battery installation

- USE ONLY Ni-MH batteries AAA (R03) size.
- Do NOT use Alkaline/Manganese/Ni-Cd batteries.
- Confirm correct polarities (\oplus , \ominus).

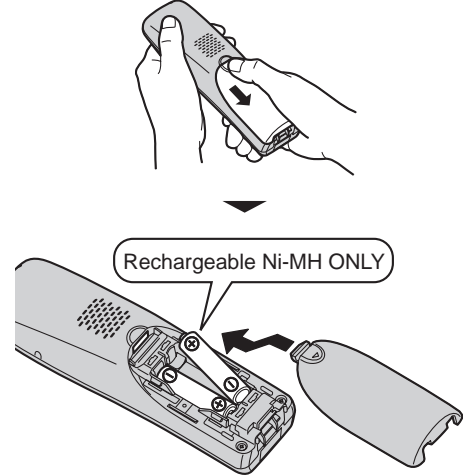

Important:

- If the handset does not automatically turn on after installing/replacing batteries, place the handset on the charger.

Battery charge

Charge for about 7 hours.

- When the batteries are fully charged, the charge indicator goes off.

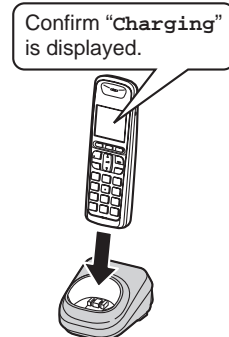

Note when setting up

Note for connections

- The AC adaptor must remain connected at all times. (It is normal for the adaptor to feel warm during use.)
- The AC adaptor should be connected to a vertically oriented or floor-mounted AC outlet. Do not connect the AC adaptor to a ceiling-mounted AC outlet, as the weight of the adaptor may cause it to become disconnected.

During a power failure

The base unit will work as a standard telephone using power from the telephone line, so you can make and answer outside calls with the corded handset. However, this operation may not work properly depending on area or telephone line's condition. The base unit speakerphone and the cordless handset will not function during a power failure.





Note for battery installation

- Use the supplied rechargeable batteries. For replacement, we recommend using the Panasonic rechargeable batteries noted on page 4, 5.
- Wipe the battery ends (+, -) with a dry cloth.
- Avoid touching the battery ends (+, -) or the unit contacts.

Note for battery charge

- It is normal for the handset to feel warm during charging.
- Clean the charge contacts of the handset and charger with a soft and dry cloth once a month. Clean more often if the unit is exposed to grease, dust, or high humidity.

Battery level

Icon	Battery level
	High
	Medium
	Low
	Needs charging.
	Empty

Note:

- The batteries need to be charged if the handset beeps while you are engaged in a call or operating the answering system remotely.

Panasonic Ni-MH battery performance (supplied batteries)

Operation	Operating time
In continuous use	12 hours max.
Not in use (standby)	6 days max.

Note:

- Actual battery performance depends on a combination of how often the handset is in use and how often it is not in use (standby).
- Even after the handset is fully charged, the handset can be left on the charger without any ill effect on the batteries.
- The battery level may not be displayed correctly after you replace the batteries. In this case, place the handset on the charger and let it charge for at least 7 hours.

Controls

Base unit

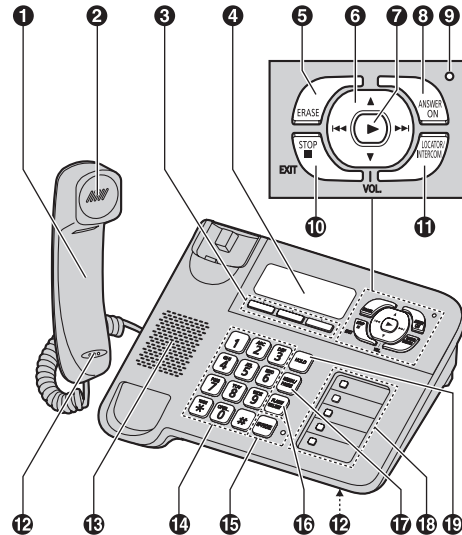

- 1 Corded handset
- 2 Receiver
- 3 Soft keys
- 4 Display
- 5 [ERASE]
- 6 Navigator key ([▲]/[▼])
VOL.: Volume ([▲]/[▼])
Repeat/Skip ([◀◀]/[▶▶])
- 7 [▶] (Play)
Message indicator
- 8 [ANSWER ON]
- 9 ANSWER ON indicator
- 10 [■] (STOP) (EXIT)
- 11 [LOCATOR] [INTERCOM]
- 12 Microphone
- 13 Speaker
- 14 Dial keypad ([*]: TONE)
- 15 [SP-PHONE] (Speakerphone)
SP-PHONE indicator
- 16 [FLASH] [CALL WAIT]
- 17 [REDIAL] [PAUSE]
- 18 Speed dial buttons
- 19 [HOLD]

Handset

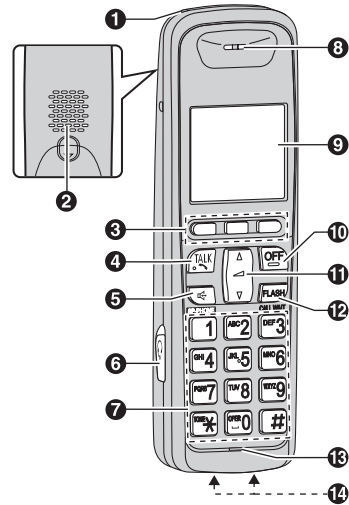

- 1 Charge indicator
Ringer indicator
Message indicator
- 2 Speaker
- 3 Soft keys
- 4 [TALK]
- 5 [SP-PHONE: Speakerphone]
- 6 Headset jack
- 7 Dial keypad ([*]: TONE)
- 8 Receiver
- 9 Display
- 10 [OFF]
- 11 Navigator key ([▲]/[▼])
▲: Volume ([▲]/[▼])
- 12 [FLASH] [CALL WAIT]
- 13 Microphone
- 14 Charge contacts

Using the navigator key/volume key (VOL., ▲)

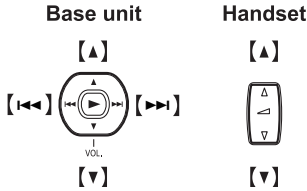

■ Scrolling through lists or items

By pressing this key (▲) or (▼) repeatedly, you can scroll through (up or down) various lists or items.

■ Adjusting the volume

By pressing this key (▲) or (▼) repeatedly, you can adjust the receiver or speaker volume (up or down) while talking.

■ Moving the cursor

Base unit: ▲, ▼, ◀, or ▶

Handset: ▲ or ▼

By pressing the above keys repeatedly, you can move the cursor to edit a number or name.

Soft keys

Each unit features 3 soft keys. By pressing a soft key, you can select the feature shown directly above it on the display.

Base unit

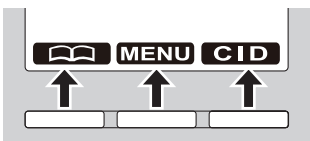

Handset

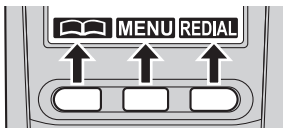

Display

Base unit display items



Item	Meaning
IN USE	The line is in use. <ul style="list-style-type: none"> When flashing: <ul style="list-style-type: none"> The call is put on hold. The answering system is being operated from outside remotely. When flashing rapidly: an incoming call is now being received.
🔕	Ringer volume is off. (page 14)
🔕	Silent mode is on. (page 25)
🕒	The recording time is set to "Greeting only". (page 35)
🚫	Blocked call (page 26)

Handset display items

Item	Meaning
📶	Within range of a base unit <ul style="list-style-type: none"> When flashing: Handset is searching for the base unit. (page 43)
IN USE	The line is in use. <ul style="list-style-type: none"> When flashing: <ul style="list-style-type: none"> The call is put on hold. The answering system is being operated from outside remotely. When flashing rapidly: An incoming call is now being received.
📞	Speakerphone is on. (page 13)
🔕	Ringer volume is off. (page 14)
🔕	Silent mode is on. (page 25)
🕒	Alarm is on. (page 25)
📱	Handset number
🔋	Battery level
🚫	Blocked call (page 26)

Initial settings

Symbol meaning:

Symbol	Meaning
	Perform with the base unit.
	Perform with the handset.
Example: [▼]/[▲]: "OFF"	Press [▼] or [▲] to select the words in quotations.

Display language

You can select either "English" or "Español" as the display language. The default setting is "English".

 Base unit /  Handset

- 1 [MENU] → [≡][1][1][0]
- 2 [▼]/[▲]: Select the desired setting.
- 3 Press the middle soft key to save.
- 4 Proceed with the operation for your unit.
Base unit: [■] (EXIT)
Handset: [OFF]

Voice guidance language

You can select either "English" or "Español" as the voice guidance language of the answering system. The default setting is "English".

 Handset

- 1 [MENU] → [≡][1][1][2]
- 2 [▼]/[▲]: Select the desired setting.
- 3 [SAVE] → [OFF]

Dialing mode

If you cannot make calls, change this setting according to your telephone line service. The default setting is "Tone".

"Tone": For tone dial service.

"Pulse": For rotary/pulse dial service.

 Handset

- 1 [MENU] → [≡][1][2][0]
- 2 [▼]/[▲]: Select the desired setting.
- 3 [SAVE] → [OFF]

Date and time

 Handset

- 1 [MENU] → [≡][1][0][1]
- 2 Enter the current month, date, and year by selecting 2 digits for each.
Example: July 15, 2009
[0][7] [1][5] [0][9]
- 3 [OK]
- 4 Enter the current hour and minute (12-hour clock format) by selecting 2 digits for each.
Example: 9:30
[0][9] [3][0]
- 5 [AM/PM]: Select "AM" or "PM".
- 6 [SAVE] → [OFF]

Note:

- When English is selected as the display language, 12-hour clock format is used. When Spanish is selected, 24-hour clock format is used.
- To correct a digit, press [▲] or [▼] to move the cursor to the digit, then make the correction.
- The date and time may be incorrect after a power failure. In this case, set the date and time again.

Making calls

Using the base unit

- 1 Dial the phone number.
 - To correct a digit, press **[CLEAR]**.
- 2 Lift the corded handset.
- 3 When you finish talking, place the corded handset on the cradle.

Note:

- You can also dial the phone number after lifting the corded handset.

Using the speakerphone

- 1 During a conversation with the corded handset, press **[SP-PHONE]** to turn on the speakerphone.
 - You can place the corded handset on the cradle.
 - Speak into the base unit microphone.
 - Speak alternately with the other party.
- 2 When you finish talking, press **[SP-PHONE]**.

Note:

- For best performance, use the speakerphone in a quiet environment.
- To switch to the receiver, lift the corded handset.

Using the handset

- 1 Lift the handset and dial the phone number.
 - To correct a digit, press **[CLEAR]**.
- 2 
- 3 When you finish talking, press **[OFF]** or place the handset on the charger.

Using the speakerphone

- 1 During a conversation, press  to turn on the speakerphone.
 - Speak alternately with the other party.
- 2 When you finish talking, press **[OFF]**.

Note:

- For best performance, use the speakerphone in a quiet environment.
- To switch to the receiver, press .

Adjusting the receiver or speaker volume

Base unit / Handset

Press **[▲]** or **[▼]** repeatedly while talking.

Making a call using the redial list

The last 10 phone numbers dialed are stored in the redial list in each unit (each 48 digits max.).

Base unit / Handset

- 1 **[REDIAL]**
- 2 **[▼]/[▲]**: Select the desired phone number.
- 3 Proceed with the operation for your unit.
Base unit: Lift the corded handset.
Handset: 

Erasing a number in the redial list

- 1 **[REDIAL]**
- 2 **[▼]/[▲]**: Select the desired phone number.
 → **[ERASE]** (soft key)
- 3 **[▼]/[▲]**: “Yes” → **[SELECT]**
- 4 Proceed with the operation for your unit.
Base unit: **[■]** (EXIT)
Handset: **[OFF]**

Pause (for PBX/long distance service users)

A pause is sometimes required when making calls using a PBX or long distance service. When storing a calling card access number and/or PIN in the phonebook, a pause is also needed (page 18).

Base unit / Handset

Example: If you need to dial the line access number “9” when making outside calls with a PBX:

- 1 **[9]** → **[PAUSE]**
- 2 Dial the phone number.
- 3 Proceed with the operation for your unit.
Base unit: Lift the corded handset.
Handset: 

Note:

- A 3.5 second pause is inserted each time **[PAUSE]** is pressed. Repeat as needed to create longer pauses.

Answering calls

Using the base unit

When a call is being received, the SP-PHONE indicator flashes rapidly.

- 1 Lift the corded handset or press **[SP-PHONE]** when the unit rings.
- 2 When you finish talking, place the corded handset on the cradle. When the speakerphone is used, press **[SP-PHONE]**.

Adjusting the base unit ringer volume

■ While the base unit is ringing for an incoming call:

Press **[▲]** or **[▼]** repeatedly to select the desired volume.

■ Programming the volume beforehand:

- 1 **[MENU]** → **[⇐][1][6][0]**
- 2 **[▼]/[▲]**: Select the desired volume.
- 3 **[SAVE]** → **[■]** (EXIT)

Using the handset

When a call is being received, the ringer indicator flashes rapidly.

- 1 Lift the handset and press **[↶]** or **[📞]** when the unit rings.
 - You can also answer the call by pressing any dial key from **[0]** to **[9]**, **[*]**, or **[⇐]**.
(Any key answer feature)
- 2 When you finish talking, press **[OFF]** or place the handset on the charger.

Auto talk

You can answer calls simply by lifting the handset off the charger. You do not need to press **[↶]**. To turn this feature on, see page 22.

Adjusting the handset ringer volume

■ While the handset is ringing for an incoming call:

Press **[▲]** or **[▼]** repeatedly to select the desired volume.

■ Programming the volume beforehand:

- 1 **[MENU]** → **[⇐][1][6][0]**
- 2 **[▼]/[▲]**: Select the desired volume.
- 3 **[SAVE]** → **[OFF]**

Temporary handset ringer off

While the handset is ringing for a call, you can turn the ringer off temporarily by pressing **[⌫]**.

Useful features during a call

Hold

This feature allows you to put an outside call on hold.

Base unit

- 1 Press **[HOLD]** during an outside call.
 - If you are using the corded handset, you can place it on the cradle.
- 2 To release hold, lift the corded handset or press **[SP-PHONE]**.
 - A handset user can take the call by pressing **[↶]**.

Handset

- 1 Press **[HOLD]** then press **[OFF]** during an outside call.
- 2 To release hold, press **[↶]**.
 - Another user can take the call by lifting the corded handset from the base unit or pressing **[↶]** on the handset.

Note for base unit and handset:

- If a call is kept on hold for more than 9 minutes, an alarm tone starts to sound and the ringer indicator on the handset flashes. After 1 additional minute on hold, the call is disconnected.
- If another phone is connected to the same line, you can also take the call by lifting its handset.
- While an outside call is on hold, the SP-PHONE indicator on the base unit flashes.

Mute

While mute is turned on, you can hear the other party, but the other party cannot hear you.

 Base unit /  Handset

- 1 Press **[MUTE]** during an outside call.
 - **[MUTE]** flashes.
- 2 To return to the conversation, press **[MUTE]** again.

Note:

- **[MUTE]** is a soft key visible on the display during a call.

Flash

 Base unit /  Handset

[FLASH] allows you to use the special features of your host PBX such as transferring an extension call, or accessing optional telephone services.

Note:

- To change the flash time, see page 23.

For call waiting or Call Waiting Caller ID service users

To use call waiting, you must first subscribe to call waiting from your service provider/telephone company.

This feature allows you to receive calls while you are already talking on the phone. If you receive a call while on the phone, you will hear a call waiting tone.

If you subscribe to both Caller ID and Call Waiting with Caller ID services, the 2nd caller's information is displayed on the base unit or handset that is in use after you hear the call waiting tone.

 Base unit /  Handset

- 1 Press **[CALL WAIT]** to answer the 2nd call.
- 2 To switch between calls, press **[CALL WAIT]**.

Note:

- Please contact your service provider/telephone company for details and availability of this service in your area.

Temporary tone dialing (for rotary/pulse service users)

You can temporarily switch the dialing mode to tone when you need to access touch-tone services (for example, answering services, telephone banking services, etc.).

 Base unit /  Handset

Press **[*]** (TONE) before entering access numbers which require tone dialing.

Call share

This feature allows you to join an existing outside call.

 Base unit

To join the conversation, lift the corded handset when the handset is on an outside call.

 Handset

To join the conversation, press **[↶]** when the other unit is on an outside call.

Note for handset and base unit:

- A maximum of 3 parties (including 1 outside party) can join a conversation.



Base unit/handset phonebook

The phonebook allows you to make calls without having to dial manually. You can add names and phone numbers to the base unit and handset phonebook independently, and assign each phonebook entry to the desired group.

- Base unit: up to 100 entries
- Handset: up to 100 entries

Adding entries

 Base unit /  Handset





- 1  → [ADD]
- 2 Enter the party's name (16 characters max.). → [OK]
- 3 Enter the party's phone number (24 digits max.). → [OK]
- 4 /[▲]: Select the desired group. → [SELECT] 2 times
 - To add other entries, repeat from step 2.
- 5 Proceed with the operation for your unit.
 - Base unit:** [■] (EXIT)
 - Handset:** [OFF]

Note:

- **Handset only:** If you do not press any dial key within 5 seconds after entering a character, the character is fixed and the cursor moves to the right.
- Caller ID subscribers can use group ringer tone feature (page 28).

Character table for entering names

Key	Character
[1]	Space # & ' () * , - . / 1
[2]	a b c A B C 2
[3]	d e f D E F 3
[4]	g h i G H I 4
[5]	j k l J K L 5
[6]	m n o M N O 6
[7]	p q r s P Q R S 7
[8]	t u v T U V 8
[9]	w x y z W X Y Z 9

Key	Character
[0]	Space 0
 ^{*1}  ^{*2}	To move the cursor to the right
 ^{*1}  ^{*2}	To move the cursor to the left

*1 Base unit only





*2 Handset only

- To enter another character that is located on the same dial key:

Base unit: Press  to move the cursor to the next space.

Handset: Press  to move the cursor to the next space.

Correcting a mistake

- 1 Proceed with the operation for your unit.
 - Base unit:** Press  or  to move the cursor to the character or number you want to erase.
 - Handset:** Press  or  to move the cursor to the character or number you want to erase.
- 2 Press [CLEAR], and then enter the appropriate character or number.
 - Press and hold [CLEAR] to erase all characters or numbers.





Groups

Groups can help you find entries in the phonebook quickly and easily. When adding an entry to the phonebook, you can assign it to one of 9 groups. You can change the names of groups assigned for phonebook entries ("Friends", "Family", etc.) and then search for phonebook entries by group. The group ringer tone feature is available for Caller ID subscribers (page 28).

Changing group names

The default group name is "Group 1" to "Group 9".

 Base unit /  Handset

- 1  → [MENU]
- 2 /[▲]: "Group" → [SELECT]
- 3 /[▲]: Select the desired group. → [SELECT]
- 4 /[▲]: "Group name" → [SELECT]

- 5 Edit the name (10 characters max.; page 16).
→ **[SAVE]**
- 6 Proceed with the operation for your unit.
Base unit: **[■]** (EXIT)
Handset: **[OFF]**

Finding and calling a phonebook entry

 Base unit /  Handset

Scrolling through all entries

- 1 
- 2 **[▼]/[▲]**: Select the desired entry.
- 3 Proceed with the operation for your unit.
Base unit: Lift the corded handset.
Handset: **[↶]**

Searching by first character (alphabetically)

- 1 
- 2 Press the dial key (**[0] – [9]**) which contains the character you are searching for (page 16).
 - Press the same dial key repeatedly to display the first entry corresponding to each character located on that dial key.
 - If there is no entry corresponding to the character you selected, the next entry is displayed.
- 3 **[▼]/[▲]**: Scroll through the phonebook if necessary.
- 4 Proceed with the operation for your unit.
Base unit: Lift the corded handset.
Handset: **[↶]**

Searching by group

- 1  → **[GROUP]**
- 2 **[▼]/[▲]**: Select the group you want to search.
→ **[SELECT]**
 - If you select “**All groups**”, the unit ends the group search.
- 3 **[▼]/[▲]**: Scroll through the phonebook if necessary.
- 4 Proceed with the operation for your unit.
Base unit: Lift the corded handset.
Handset: **[↶]**

Editing entries

 Base unit /  Handset

- 1 Find the desired entry (page 17). → **[EDIT]**
- 2 Edit the name if necessary (16 characters max.; page 16). → **[OK]**
- 3 Edit the phone number if necessary (24 digits max.). → **[OK]**
- 4 **[▼]/[▲]**: Select the desired group (page 16).
→ **[SELECT]** 2 times
- 5 Proceed with the operation for your unit.
Base unit: **[■]** (EXIT)
Handset: **[OFF]**

Erasing entries

 Base unit /  Handset

Erasing an entry

- 1 Find the desired entry (page 17). → **[MENU]**
- 2 **[▼]/[▲]**: “**Erase**” → **[SELECT]**
- 3 **[▼]/[▲]**: “**Yes**” → **[SELECT]**
- 4 Proceed with the operation for your unit.
Base unit: **[■]** (EXIT)
Handset: **[OFF]**

Erasing all entries

- 1  → **[MENU]**
- 2 **[▼]/[▲]**: “**Erase all**” → **[SELECT]**
- 3 **[▼]/[▲]**: “**Yes**” → **[SELECT]**
- 4 **[▼]/[▲]**: “**Yes**” → **[SELECT]**
- 5 Proceed with the operation for your unit.
Base unit: **[■]** (EXIT)
Handset: **[OFF]**

Chain dial

This feature allows you to dial phone numbers in the phonebook while you are on a call. This feature can be used, for example, to dial a calling card access number or bank account PIN that you have stored in the phonebook, without having to dial manually.

 Base unit /  Handset

- 1 During an outside call, press **[📖]**.
- 2 **[▼]/[▲]**: Select the desired entry.
- 3 Press **[CALL]** to dial the number.

Note:

- When storing a calling card access number and your PIN in the phonebook as one phonebook entry, press **[PAUSE]** to add pauses after the number and PIN as necessary (page 13).
- If you have rotary/pulse service, you need to press **[✳]** before pressing **[📖]** in step 1 to change the dialing mode temporarily to tone. When adding entries to the phonebook, we recommend adding **[✳]** to the beginning of phone numbers you wish to chain dial (page 16).

Speed dial

You can assign 1 phone number from the phonebook to each of the 5 speed dial buttons.

 Base unit

Assigning a phonebook entry to a speed dial button

- 1 Find the desired entry (page 17).
- 2 Press the speed dial button you want to assign to. → **[SELECT]**
 - If “**Overwrite**” is displayed, the button you selected has a phone number already assigned to it.
 - To overwrite with the currently selected phone number, go to step 3.
 - To select another button, press **[BACK]**, then repeat this step.
- 3 **[SELECT]** → **[■]** (EXIT)

Note:

- In step 2, you can also press **[MENU]**. → **[▼]/[▲]**: “**Speed dial**” → **[SELECT]** → **[▼]/[▲]**: Select the desired speed dial button. → **[SELECT]**
- If a speed dial button has already been assigned, “✓” is displayed next to the button in step 2.

Making a call using a speed dial button

- 1 Press the desired speed dial button.
- 2 Lift the corded handset.

Note:

- In step 1, if no phone number is stored to the speed dial button, you can assign a number by pressing **[📖]** and continue from step 1, “Assigning a phonebook entry to a speed dial button”, page 18.

Canceling a speed dial assignment

- 1 Press the desired speed dial button. → **[ERASE]** (soft key)
- 2 **[▼]/[▲]**: “**Yes**” → **[SELECT]**

Index card

Use the index card to record the names/phone numbers stored to the speed dial buttons.

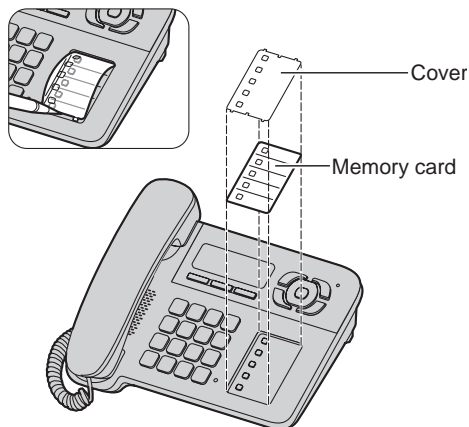

Copying phonebook entries

You can copy phonebook entries from the base unit to a handset, and vice versa.

Important:

- Groups (including their names and ringer tones) are not copied.
- You cannot make phonebook copy between handsets directly. However it is possible by first copying a handset's phonebook entries to the base unit, then copying the base unit's phonebook entries to another handset.

Copying an entry

Base unit

- 1 Find the desired entry (page 17). → **[MENU]**
- 2 **[▼]/[▲]**: "Copy" → **[SELECT]**
- 3 Enter the handset number to copy to.
 - When an entry has been copied, "Completed" is displayed.
 - To continue copying another entry: **[▼]/[▲]**: "Yes" → **[SELECT]** → Find the desired entry (page 17). → **[SELECT]**
- 4 **[■]** (EXIT)

Handset

- 1 Find the desired entry (page 17). → **[MENU]**
- 2 **[▼]/[▲]**: "Copy to base" → **[SELECT]**
 - When an entry has been copied, "Completed" is displayed.
 - To continue copying another entry: **[▼]/[▲]**: "Yes" → **[SELECT]** → Find the desired entry (page 17). → **[SELECT]**
- 3 **[OFF]**

Copying all entries

Base unit

- 1 **[📖]** → **[MENU]**
- 2 **[▼]/[▲]**: "Copy all" → **[SELECT]**
- 3 Enter the handset number to copy to.
 - When all entries have been copied, "Completed" is displayed.
- 4 **[■]** (EXIT)

Handset

- 1 **[📖]** → **[MENU]**
- 2 **[▼]/[▲]**: "Copy all to base" → **[SELECT]**
 - When all entries have been copied, "Completed" is displayed.
- 3 **[OFF]**

Programmable settings

You can customize the unit by programming the following features.

To access the features, there are 2 methods:

- scrolling through the display menus (page 20)
- using the direct commands (page 22)
- Direct command is the main method used in these operating instructions.

Programming by scrolling through the display menus

 Base unit /  Handset

- 1 **[MENU]**
- 2 Press **[▼]** or **[▲]** to select the desired main menu. → **[SELECT]**
- 3 Press **[▼]** or **[▲]** to select the desired item in sub-menu 1. → **[SELECT]**
 - In some cases, you may need to select from sub-menu 2. → **[SELECT]**
- 4 Press **[▼]** or **[▲]** to select the desired setting. → **[SAVE]**
 - This step may vary depending on the feature being programmed.
 - To exit the operation, press **[■]** (EXIT) on the base unit or **[OFF]** on the handset.

Note:

- See page 22 for the default settings.

Base unit

Main menu	Sub-menu 1	Sub-menu 2	Page
Caller list →)	–	–	28
Set answering ☎	Screen call	–	31
Initial setting ⊞⊞	Ringer setting	Ringer volume	14
		Ringer tone	–
		Silent mode – On / Off – Start / End	25
	Call block ^{*1}	–	26
	LCD contrast	–	–
	Caller ID edit	–	29
Display language	–	12	
Customer support ?🌐	–	–	–

*1 If you program these settings using the base unit, you do not need to program the same item using a handset.

Handset

Main menu	Sub-menu 1	Sub-menu 2	Page	
Caller list →)]	-	-	28	
Answering device ☎	Play new msg.	-	33	
	Play all msg.	-	33	
	Erase all msg.* ¹	-	33	
	Greeting	Record greeting* ¹		31
		Check greeting		32
		Pre-recorded* ¹		32
	Settings	Ring count* ¹		35
		Recording time* ¹		35
		Remote code* ¹		34
Screen call			31	
Answer on* ¹	-	31		
Answer off* ¹	-	31		
Intercom ☎))	-	-	38	
Initial setting ☎=	Ringer setting	Ringer volume	14	
		Ringer tone	-	
		Silent mode - On / Off	25	
		- Start / End		
	Set date / time	Date and time* ¹	12	
		Alarm	25	
		Time adjust* ¹	-	
	Call block* ¹	-	26	
	Message alert	-	36	
	LCD contrast	-	-	
	Key tone	-	-	
	Auto talk	-	14	
	Set tel line	Set dial mode* ¹	12	
		Set flash time* ¹	15	
		Set line mode* ¹	-	
		VM tone detect* ¹	37	
		Caller ID edit	29	
	Registration	Register handset	27	
		Deregistration	27	
Change language	Display	12		
	Voice prompt* ¹	12		
Customer support ?☎	-	-	-	

*1 If you program these settings using one of the handsets, you do not need to program the same item using another unit.

Programming using the direct commands



1 [MENU] → [⇄]



















2 Enter the desired feature code.



















3 [▼]/[▲]: Select the desired setting. → [SAVE]

- This step may vary depending on the feature being programmed.
- To exit the operation, press [■](EXIT) on the base unit or [OFF] on the handset.



Note:

- The operating unit column shows the unit(s) that can be used to program the item.
 - : Only the base unit can program the item.
 - : Only the handset can program the item.
 - : Both the base unit and handset can program the item.
- In the following table, < > indicates the default settings.

Operating unit	Feature	Feature code	Setting	System setting*1	Page
	Alarm	[7][2][0]	<Off> Once Daily	–	25
	Answer off	[3][2][8]	–	●	31
	Answer on	[3][2][7]	–	●	31
	Auto talk*2	[2][0][0]	On <Off>	–	14
	Block w/o num. (Block calls without phone number)	[2][4][0]	On <Off>	●	26
	Call block	[2][1][7]	–	●	26
	Caller ID edit (Caller ID number auto edit)	[2][1][4]	<On> Off	–	29
	Caller list	[2][1][3]	–	–	28
	Check greeting	[3][0][3]	–	–	32
	Customer support*3	[6][8][0]	–	–	–
	Date and time	[1][0][1]	–	●	12
	Deregistration	[1][3][1]	–	–	27
	Display language	[1][1][0]	<English> Español	–	12
	Display (Change language)				
	Erase all msg. (msg.: messages)	[3][2][5]	–	●	33
	Intercom	[2][7][4]	–	–	38
	Key tone*4	[1][6][5]	<On> Off	–	–
	LCD contrast (Display contrast)	[1][4][5]	Level 1–6 <3>	–	–

Operating unit	Feature	Feature code	Setting	System setting ^{*1}	Page
	Message alert	[3][4][0]	On <Off>	–	36
	Play all msg. (msg.: messages)	[3][2][4]	–	–	33
	Play new msg. (msg.: messages)	[3][2][3]	–	–	33
	Pre-recorded (Reset to pre-recorded greeting)	[3][0][4]	–	●	32
	Record greeting	[3][0][2]	–	●	31
	Recording time	[3][0][5]	lmin <3min> Greeting only	●	35
	Register handset	[1][3][0]	–	–	27
	Remote code	[3][0][6]	<111>	●	34
	Ring count	[2][1][1]	Toll saver 2–7 rings <4>	●	35
	Ringer tone ^{*5, *6}	[1][6][1]	Base unit: Tone <1>–6 Handset^{*7}: Tone <1>–5 Melody 1–10	–	–
	Ringer volume ^{*8}	[1][6][0]	Base unit: Level 1–<3>, Off Handset: Level 1–<6>, Off	–	14
	Screen call	[3][1][0]	<On> Off	–	31
	Set dial mode	[1][2][0]	<Tone> Pulse	●	12
	Set flash time ^{*9}	[1][2][1]	80ms 90ms 100ms 110ms 160ms 200ms 250ms 300ms 400ms 600ms <700ms> 900ms	●	15
	Set line mode ^{*10}	[1][2][2]	A 	●	–
	Silent mode (On/Off)	[2][3][8]	On <Off>	–	25
	Silent mode (Start/End)	[2][3][7]	<11:00 PM/06:00 AM>	–	25
	Time adjust ^{*11} (Caller ID subscribers only)	[2][2][6]	<Caller ID auto> Manual	●	–

Programming

Operating unit	Feature	Feature code	Setting	System setting ^{*1}	Page
	VM tone detect (VM: Voice mail)	[3][3][2]	<On> Off	●	37
	Voice prompt (Change language)	[1][1][2]	<English> Español	●	12

*1 If “System setting” column is checked, you do not need to program the same item using another unit.

*2 If you subscribe to a Caller ID service and want to view the caller’s information after lifting up the handset to answer a call, turn off this feature.

*3 The base unit and handset can display the Internet address where you can download the operating instructions or get further information for this product, using your computer.

*4 Turn this feature off if you prefer not to hear key tones while you are dialing or pressing any keys, including confirmation tones and error tones.

*5 If you subscribe to a distinctive ring service (such as IDENT-A-RING), select a tone (base unit: tone 1 to 6/handset: tone 1 to 5). If you select a melody, you cannot distinguish lines by their ringers.

*6 If you select one of the melody ringer tones, the ringer tone continues to play for several seconds even if the caller has already hung up. You may either hear a dial tone or no one on the line when you answer the call.

*7 The preset tones and melodies in this product are used with permission of © 2007 Copyrights Vision Inc.

*8 When the ringer volume is turned off, \mathcal{L} is displayed and the base unit and/or handset do not ring for outside calls.

However even when the ringer volume is set to off:

– the base unit rings at the low level for intercom calls (page 38).

– the handset rings at the lowest level for alarm (page 25) and intercom calls (page 38), and rings at the highest level for paging (page 38).

*9 The flash time depends on your telephone exchange or host PBX. Contact your PBX supplier if necessary. The setting should stay at “700ms” unless pressing **[FLASH]** fails to pick up the waiting call.

*10 Generally, the line mode setting should not be adjusted. If “New Voice Mail” is not displayed, even when the message indication service is available (page 37), you need to change the line mode to “A”.

*11 This feature allows the unit to automatically adjust the date and time setting when caller information is received. To use this feature, set the date and time first.

Special programming

Silent mode

Silent mode allows you to select a period of time during which the base unit and/or handset will not ring for outside calls. This feature is useful for time periods when you do not want to be disturbed, for example, while sleeping. Silent mode can be set independently for each base unit and handset.

Important:

- Set the date and time beforehand (page 12).
- **Handset only:** If you have set the alarm, the alarm sounds even if the silent mode is turned on.

Turning silent mode on/off

Base unit / Handset

- 1 **[MENU]** → **[#][2][3][8]**
- 2 **[▼]/[▲]**: Select “on” or “off”. → **[SAVE]**
 - If you select “off”, press **[■]** (EXIT) on the base unit or **[OFF]** on the handset to exit.
- 3 Enter the desired hour and minute you wish to start this feature.
- 4 **[AM/PM]**: Select “AM” or “PM”. → **[OK]**
- 5 Enter the desired hour and minute you wish to end this feature.
- 6 **[AM/PM]**: Select “AM” or “PM”.
- 7 **[SAVE]**
- 8 Proceed with the operation for your unit.

Base unit: **[■]** (EXIT)

Handset: **[OFF]**

 - When the silent mode is set, **Zz** is displayed.

Note:

- To correct a digit, proceed with the operation for your unit.

Base unit: press **[◀]** or **[▶]** to move the cursor to the digit, then make the correction.

Handset: press **[▲]** or **[▼]** to move the cursor to the digit, then make the correction.

Changing the start and end time

- 1 **[MENU]** → **[#][2][3][7]**
- 2 Continue from step 3, “Turning silent mode on/off”, page 25.

Alarm

An alarm sounds at the set time for 3 minutes once or daily. Alarm can be set for each handset.

Important:

- Set the date and time beforehand (page 12).

Handset

- 1 **[MENU]** → **[#][7][2][0]**
- 2 **[▼]/[▲]**: Select the desired alarm option. → **[SELECT]**

off	Turns alarm off. Go to step 6.
Once	An alarm sounds once at the set time.
Daily	An alarm sounds daily at the set time. Go to step 4.

- 3 Enter the desired month and date. → **[OK]**
- 4 Set the desired time. → **[OK]**
- 5 **[▼]/[▲]**: Select the desired ringer tone. → **[SELECT]**
 - We recommend selecting a ringer tone different from the ringer tone set for outside calls.
- 6 **[▼]/[▲]**: “Save” → **[SELECT]** → **[OFF]**
 - When the alarm is set,  is displayed.

Note:

- To stop the alarm, press any dial key or place the handset on the charger.
- When the handset is in use, the alarm will not sound until the handset is in standby mode.
- If you select “once”, the setting changes to “off” after the alarm sounds.

Call block (Caller ID subscribers only)

This feature allows the unit to reject calls when:

- the unit receives a call from a phone number stored in the call block list as unwanted (“Storing unwanted callers”, page 26).
- the unit receives a call without phone number (“Block calls without phone number”, page 26).

When a call is received, the unit rings for a short time while the caller is being identified. If the unit recognizes the call as unwanted, “**Caller blocked**” is displayed and the unit sends out a busy tone to the caller, and then disconnects the call.

Program this setting using either the base unit or one of the handsets.

Important:

- When the unit receives a call from a number that is stored in the call block list or a call without a recognized phone number, the call is logged in the caller list (page 28) with  after the call is disconnected.

Storing unwanted callers

You can store up to 30 phone numbers in the call block list by using the caller list or by entering the numbers directly.

Important:

- It is advised to store the 10 digits (including an area code) because if 7 digits are stored, all numbers that have the last 7 digits will be blocked.

 Base unit /  Handset

■ From the caller list:

- 1 Proceed with the operation for your unit.
Base unit: [CID]
Handset: [MENU] → [▼]/[▲]: “**Caller list**” → [SELECT]
- 2 [▼]/[▲]: Select the entry to be blocked.
 - To edit the number, press [EDIT] repeatedly until the phone number is shown in the 10-digit format.
- 3 [SAVE]
- 4 [▼]/[▲]: “**Call block**” → [SELECT]
- 5 [▼]/[▲]: “**Yes**” → [SELECT]
- 6 Proceed with the operation for your unit.
Base unit: [■] (EXIT)

Handset: [OFF]

■ By entering phone numbers:

- 1 [MENU] → [≡][2][1][7] → [ADD]
- 2 Enter the phone number (24 digits max.).
 - To erase a digit, press [CLEAR].
- 3 [SAVE]
- 4 Proceed with the operation for your unit.
Base unit: [■] (EXIT)
Handset: [OFF]

Block calls without phone number

You can reject a call without phone number including “**Out of area**”, “**Private caller**”, or “**Long distance**”.

 Base unit /  Handset

- 1 [MENU] → [≡][2][4][0]
- 2 [▼]/[▲]: Select the desired setting. → [SAVE]
- 3 Proceed with the operation for your unit.
Base unit: [■] (EXIT)
Handset: [OFF]

Viewing/editing/erasing call block numbers

 Base unit /  Handset

- 1 [MENU] → [≡][2][1][7]
- 2 [▼]/[▲]: Select the desired entry.
 - To exit, press [■] (EXIT) on the base unit or [OFF] on the handset.
- 3 Proceed with the desired operation.
 - **Editing a number:**
[EDIT] → Edit the phone number. → [SAVE] → Press [■] (EXIT) on the base unit or [OFF] on the handset.
 - **Erasing a number:**
[ERASE] (soft key) → [▼]/[▲]: “**Yes**” → [SELECT] → Press [■] (EXIT) on the base unit or [OFF] on the handset.

Note:

- When editing, press the desired dial key to add, [CLEAR] to erase.
- When viewing, [w/o NUM] appears if the block calls without phone number feature is turned on. To turn the feature off: [w/o NUM] → [▼] → [SAVE] → Press [■] (EXIT) on the base unit or [OFF] on the handset.

Registering a unit

Operating additional units

Additional handsets

Up to 6 handsets can be registered to the base unit.

Important:

- See page 4 for information on the available model.

Registering a handset to a base unit

The supplied handset and base unit are pre-registered. If for some reason the handset is not registered to the base unit, re-register the handset.

1 Handset:

[MENU] → **[#][1][3][0]**

2 Base unit:

Press and hold **[LOCATOR]** for about 5 seconds until the registration tone sounds.

- If all registered handsets start ringing, press the same button to stop. Then repeat from step 1.
- The next step must be completed within 90 seconds.

3 Handset:

Press **[OK]**, then wait until a long beep sounds.

Note:

- When you purchase an additional handset, refer to the additional handset's installation manual for registration.

Deregistering a handset

A handset can cancel its own registration (or the registration of another handset) that is stored to the base unit. This allows the handset to end its wireless connection with the system.

1 [MENU] → **[#][1][3][1]**

2 [3][3][5] → **[OK]**

3 Select the handset you want to cancel by pressing the desired handset(s) number.

- The selected handset number(s) flashes.
- To cancel a selected handset number, press the number again. The number will stop flashing.

4 [OK] → **[▼]/[▲]**: "Yes" → **[SELECT]**

- When you cancel a different handset than the one you are now using, press **[OFF]** to exit.

Using Caller ID service

Important:

- This unit is Caller ID compatible. To use Caller ID features, you must subscribe to a Caller ID service. Contact your service provider/ telephone company for details.

Caller ID features

When an outside call is being received, the caller's name and phone number are displayed.

Caller information for the last 50 callers is logged in the caller list from the most recent call to the oldest.

- If the unit cannot receive caller information, the following is displayed:
 - “**Out of area**”: The caller dials from an area which does not provide a Caller ID service.
 - “**Private caller**”: The caller requests not to send caller information.
 - “**Long distance**”: The caller makes a long distance call.
- If the unit is connected to a PBX system, caller information may not be properly received. Contact your PBX supplier.

Missed calls

If a call is not answered, the unit treats it as a missed call. The display shows “**Missed call**”. This lets you know if you should view the caller list to see who called while you were away.

Phonebook name display

When caller information is received and it matches a phone number stored in the phonebook, the stored name in the phonebook is displayed and logged in the caller list.

Group ringer tone for phonebook

This feature can help you identify who is calling by using different ringer tones for different groups of callers. When adding an entry to the phonebook, you can assign it to the desired group (page 16). When a call is received from a caller assigned to a group, the group's ringer you selected rings after the caller information is displayed. If you select “**No ringer ID**” (default), the unit uses the

ringer tone you selected on page 23 when calls from this group are received.

Base unit / Handset

- 1  → **[MENU]**
- 2 **[▼]/[▲]**: “**Group**” → **[SELECT]**
- 3 **[▼]/[▲]**: Select the desired group. → **[SELECT]**
- 4 **[▼]/[▲]**: Select the current setting of the group ringer tone. → **[SELECT]**
- 5 **[▼]/[▲]**: Select the desired entry. → **[SAVE]**
- 6 Proceed with the operation for your unit.
Base unit: **[■]** (EXIT)
Handset: **[OFF]**

Caller list

Important:

- Only 1 person can access the caller list at a time.
- Make sure the unit's date and time setting is correct (page 12).

Viewing the caller list and calling back

Base unit / Handset

- 1 Proceed with the operation for your unit.
Base unit: **[CID]**
Handset: **[MENU]** → **[▼]/[▲]**: “**Caller list**” → **[SELECT]**
- 2 Press **[▼]** to search from the most recent call, or **[▲]** to search from the oldest call.
- 3 Proceed with the operation for your unit.
Base unit:
 - To call back, lift the corded handset.
 - To exit, press **[■]** (EXIT).**Handset:**
 - To call back, press **[↶]**.
 - To exit, press **[OFF]**.

Note:

- If the entry has already been viewed or answered, “**✓**” is displayed, even if it was viewed or answered using another unit.

Editing a caller's phone number before calling back

You can edit a phone number in the caller list by removing its area code and/or the long distance code "1".

 Base unit /  Handset

- 1 Proceed with the operation for your unit.
Base unit: [CID]
Handset: [MENU] → [▼]/[▲]: "Caller list" → [SELECT]
- 2 [▼]/[▲]: Select the desired entry.
- 3 Press [EDIT] repeatedly until the phone number is shown in the desired format.
 - ① Local phone number
Example:

321-5555
 - ② Area code – Local phone number
Example:

555-321-5555
 - ③ 1 – Area code – Local phone number
Example:

1-555-321-5555
- 4 Proceed with the operation for your unit.
Base unit: Lift the corded handset.
Handset: [↶]

Caller ID number auto edit feature

Once you call back an edited number, the unit remembers the Area Code and Format of the Edited Number. Next time when someone calls from the same Area Code, caller information is customized by the unit as follows:

- When the call is being received, the Caller ID number is displayed in the same Format as the Edited Number.
- After the call is ended, the phone number of the caller, when reviewed from the Caller list, is displayed in the same Format as the Edited Number.

For example, you can use this feature to set the unit to ignore the area code of callers in your area, so that you can call these local numbers using caller information without dialing the area code. To activate this feature, you must edit an entry in the caller list, then call that number. After that, phone numbers from that caller's area code are edited automatically.

Note:

- Phone numbers from the 4 most recently edited area codes are automatically edited.
- If you move to another area, you can turn this feature off to erase previously edited area codes. To use this feature again, turn it on and reprogram the area codes you want to edit once again.

Turning Caller ID auto edit on/off

 Base unit /  Handset

- 1 [MENU] → [≡][2][1][4]
- 2 [▼]/[▲]: Select the desired setting.
- 3 [SAVE]
- 4 Proceed with the operation for your unit.
Base unit: [■] (EXIT)
Handset: [OFF]

Erasing selected caller information

 Base unit /  Handset

- 1 Proceed with the operation for your unit.
Base unit: [CID]
Handset: [MENU] → [▼]/[▲]: “Caller list” → [SELECT]
- 2 [▼]/[▲]: Select the desired entry.
- 3 [ERASE] (soft key) → [▼]/[▲]: “Yes” → [SELECT]
- 4 Proceed with the operation for your unit.
Base unit: [■] (EXIT)
Handset: [OFF]

Erasing all caller information

 Base unit /  Handset

- 1 Proceed with the operation for your unit.
Base unit: [CID]
Handset: [MENU] → [▼]/[▲]: “Caller list” → [SELECT]
- 2 [ERASE] (soft key) → [▼]/[▲]: “Yes” → [SELECT]
- 3 Proceed with the operation for your unit.
Base unit: [■] (EXIT)
Handset: [OFF]

Storing caller information to the phonebook

 Base unit /  Handset

- 1 Proceed with the operation for your unit.
Base unit: [CID]
Handset: [MENU] → [▼]/[▲]: “Caller list” → [SELECT]
- 2 [▼]/[▲]: Select the desired entry.
 - To edit the number, press [EDIT] repeatedly until the phone number is shown in the desired format.
- 3 [SAVE]
- 4 [▼]/[▲]: “Phonebook” → [SELECT]
- 5 Continue from step 2, “Editing entries”, page 17.

Answering system

The answering system can answer and record calls for you when you are unavailable to answer the phone.

You can also set the unit to play a greeting message but not to record caller messages by selecting “**Greeting only**” as the recording time setting (page 35).

Important:

- Only 1 person can access the answering system (listen to messages, record a greeting message, etc.) at a time.
- When callers leave messages, the unit records the day and time of each message. Make sure the date and time have been set correctly (page 12).

Memory capacity

The total recording capacity (including your greeting message) is about 18 minutes. A maximum of 64 messages can be recorded.

Note:

- If message memory becomes full:
 - “**Messages full**” is shown on the base unit and handset display.
 - The ANSWER ON indicator on the base unit flashes rapidly when the answering system is turned on.
- When the message memory becomes full:
 - If you use the pre-recorded greeting message, the unit automatically switches to another pre-recorded greeting message asking callers to call again later.
 - If you recorded your own greeting message, the same message is still announced to callers even though their messages are not recorded.

Turning the answering system on/off

Base unit

Press [**ANSWER ON**] to turn on/off the answering system.

Handset

■ To turn on:

- 1 [**MENU**] → [**⏏**][3][2][7]
- 2 [**OFF**]

■ To turn off:

- 1 [**MENU**] → [**⏏**][3][2][8]
- 2 [**OFF**]

Note for base unit and handset:

- When the answering system is turned on, the ANSWER ON indicator on the base unit lights up.

Call screening

Base unit / Handset

While a caller is leaving a message, you can listen to the call through the base unit's or handset's speaker. To adjust the speaker volume, press [**▲**] or [**▼**] repeatedly.

You can answer the call by lifting the corded handset from the base unit or pressing [**📞**] on the handset.

Note:

- To turn this feature off, see page 36.

Greeting message

When the unit answers a call, a greeting message is played to callers.

You can use either:

- your own greeting message
- a pre-recorded greeting message

Recording your greeting message

Handset

- 1 [**MENU**] → [**⏏**][3][0][2]
- 2 [**▼**]/[**▲**]: “**Yes**” → [**SELECT**]
- 3 After a beep sounds, hold the handset about 20 cm (8 inches) away and speak clearly into the microphone (2 minutes 30 seconds max.).
- 4 Press [**STOP**] to stop recording.
- 5 [**OFF**]

Using a pre-recorded greeting message

The unit provides 2 pre-recorded greeting messages:

- If you erase or do not record your own greeting message, the unit plays a pre-recorded greeting asking callers to leave a message.
- If the message recording time (page 35) is set to “**Greeting only**”, callers’ messages are not recorded and the unit plays a different pre-recorded greeting message asking callers to call again.

Erasing your greeting message (Resetting to a pre-recorded greeting message)

If you want to use a pre-recorded greeting message once you record your own greeting message, you need to erase your own greeting message.

 **Handset**

[MENU] → **[#][3][0][4]** → **[YES]** → **[OFF]**

Playing back the greeting message

 **Handset**

1 [MENU] → **[#][3][0][3]**

2 [OFF]

Listening to messages using the base unit

When new messages have been recorded:

- “**New message**” is displayed.
- The message indicator on the base unit flashes.

Press **[▶]**.

- If new messages have been recorded, the base unit plays back new messages.
- If there are no new messages, the base unit plays back all messages.

Operating the answering system during playback

Key	Operation
[▲] or [▼]	Adjust the speaker volume
[◀◀]	Repeat message ^{*1}
[▶▶]	Skip message
[PAUSE]	Pause message To resume playback, press [▶] .
[■] (STOP)	Stop playback
[ERASE]	Erase currently playing message

*1 If pressed within the first 5 seconds of a message, the previous message is played.

Calling back (Caller ID subscribers only)

If caller information was received for the call, you can call the caller back while listening to a message.

Lift the corded handset during playback.

- To edit the number before calling back, press **[EDIT]** repeatedly until the phone number is shown in the desired format (page 29).

Erasing all messages

Press **[ERASE]** 2 times while the unit is not in use.

Listening to messages using the handset

When new messages have been recorded:

- "New message" is displayed.
- The message indicator on the handset flashes slowly if the message alert feature is turned on (page 36).

1 [MENU] → [PLAY]

- If new messages have been recorded, the handset plays back new messages.
- If there are no new messages, the handset plays back all messages.

2 When finished, press [OFF].

Note:

- In step 1, you can also perform each specific operation.
 - To listen to new messages:
[MENU] → [⇄][3][2][3]
 - To listen to all messages:
[MENU] → [⇄][3][2][4]
- To switch to the receiver, press [↶].

Operating the answering system

You can also operate the answering system by pressing dial keys or soft keys on the handset.

To use the following commands:

[MENU] → [▼]/[▲]: "Answering device" → [SELECT]

Key	Operation
[▲] or [▼]	Adjust the receiver/speaker volume (during playback)
[1]	Repeat message (during playback) ^{*1}
[2]	Skip message (during playback)
[3]	Enter the answering device setting menu. ^{*2}
[4]	Play new messages
[5]	Play all messages
[6]	Play greeting message
[7][6]	Record greeting message
[8]	Turn answering system on
[9] or [STOP]	Stop playback

Key	Operation
[0]	Turn answering system off
[*][4] ^{*3}	Erase currently playing message
[*][5]	Erase all messages
[*][6]	Erase greeting message ^{*4}

*1 If pressed within the first 5 seconds of a message, the previous message is played.

*2 "Ring count" is displayed first.

*3 You can also erase as follows:

[ERASE] → [▼]/[▲]: "Yes" → [SELECT]

*4 Unit resets to a pre-recorded greeting message.

Calling back (Caller ID subscribers only)

If caller information is received for the call, you can call the caller back while listening to a message.

1 Press [MENU] during playback.

2 [▼]/[▲]: "Edit & Call" → [SELECT]

- To edit the number before calling back, press [EDIT] repeatedly until the phone number is shown in the desired format (page 29).

3 [↶]

Erasing all messages

1 [MENU] → [⇄][3][2][5]

2 [▼]/[▲]: "Yes" → [SELECT] → [OFF]

Remote operation

Using a touch-tone phone, you can call your phone number from outside and access the unit to listen to messages or change answering system settings. The unit's voice guidance prompts you to press certain dial keys to perform different operations.

Remote access code

A 3-digit remote access code must be entered when operating the answering system remotely. This code prevents unauthorized parties from listening to your messages remotely. The default setting is "111".

Handset

- 1 **[MENU]** → **[#][3][0][6]**
- 2 Enter the desired 3-digit remote access code.
→ **[SAVE]** → **[OFF]**

Using the answering system remotely

- 1 Dial your phone number from a touch-tone phone.
- 2 After the greeting message starts, enter your remote access code.
 - The unit announces the number of new messages.
 - The voice guidance announcements are different depending on the voice guidance language setting (page 12).
- 3 Follow the voice guidance prompts as necessary or control the unit using remote commands (page 34).
- 4 When finished, hang up.

Note:

- You can also leave a message just as any outside caller can. After the greeting message starts, press **[*]** to skip the greeting message and record your message after the beep.

Voice guidance

When the English voice guidance is selected

During remote operation, the unit's voice guidance starts and prompts you to press **[1]** to perform a

specific operation, or press **[2]** to listen to more available operations. Operations are presented by voice guidance in the following order:

- Play back all messages
- Play back new messages
- Record your message
- Erase all messages
- Record your greeting message

Note:

- If you do not press any dial keys within 10 seconds after a voice guidance prompt, the unit disconnects your call.

When the Spanish voice guidance is selected

To start the voice guidance, press **[9]**. The voice guidance announces the available remote commands (page 34). See the Spanish quick guide for details (page 48).

Note:

- If you do not press any dial keys within 10 seconds after a voice guidance prompt, the unit disconnects your call.

Remote commands

You can press dial keys to access certain answering system functions without waiting for the voice guidance to prompt you.

Key	Operation
[1]	Repeat message (during playback) ^{*1}
[2]	Skip message (during playback)
[4]	Play new messages
[5]	Play all messages
[6]	Play greeting message
[7]	Record a greeting message
[9]	Stop recording Stop playback ^{*2} Start voice guidance ^{*3}
[0]	Turn answering system off
[*][4]	Erase currently playing message
[*][5]	Erase all messages
[*][6]	Erase greeting message (during greeting message playback) ^{*4}
[*][#]	End remote operation (or hang up)

- *1 If pressed within the first 5 seconds of a message, the previous message is played.
- *2 For English voice guidance only:
To resume operation, enter a remote command within 3 seconds, or the voice guidance starts.
- *3 For Spanish voice guidance only
- *4 Unit resets to a pre-recorded greeting message.

Turning on the answering system remotely

If the answering system is off, you can turn it on remotely.

- 1 Dial your phone number from a touch-tone phone.
- 2 Let the phone ring 15 times.
 - A long beep is heard.
- 3 Enter your remote access code within 10 seconds after the long beep.
 - The greeting message is played back.
 - You can either hang up, or enter your remote access code again and begin remote operation (page 34).

Answering system settings

Number of rings before the unit answers a call

You can change the number of times the phone rings “**Ring count**” before the unit answers calls. You can select 2 to 7 rings, or “**Toll saver**”.

The default setting is “4”.

“**Toll saver**”: The unit’s answering system answers at the end of the 2nd ring when new messages have been recorded, or at the end of the 4th ring when there are no new messages. If you call your phone from outside to listen to new messages (page 34), you know that there are no new messages when the phone rings for the 3rd time. You can then hang up without being charged for the call.

Handset

- 1 **[MENU]** → **[#][2][1][1]**
- 2 **[▼]/[▲]**: Select the desired setting. → **[SAVE]** → **[OFF]**

For voice mail service subscribers

If you subscribe to a flat-rate service package that includes Caller ID, call waiting, voice mail, and unlimited local/regional/long distance calls, please note the following:

- To use the voice mail service provided by your service provider/telephone company rather than the unit’s answering system, turn off the answering system (page 31).
- To use this unit’s answering system rather than the voice mail service provided by your service provider/telephone company, please contact your service provider/telephone company to deactivate your voice mail service.

If your service provider/telephone company cannot do this:

- Set this unit’s “**Ring count**” setting so that this unit’s answering system answers calls before the voice mail service of your service provider/telephone company does. It is necessary to check the number of rings required to activate the voice mail service provided by your service provider/telephone company before changing this setting.
- Change the number of rings of the voice mail service so that the answering system can answer the call first. To do so, contact your service provider/telephone company.

Caller’s recording time

You can change the maximum message recording time allotted to each caller. You can also select “**Greeting only**” which sets the unit to greet callers but not record messages. The default setting is “3min”.

Handset

- 1 **[MENU]** → **[#][3][0][5]**
- 2 **[▼]/[▲]**: Select the desired setting. → **[SAVE]** → **[OFF]**

Note:

- When you select “**Greeting only**”:
 - If you do not record your own message, the unit will play the pre-recorded greeting-only message asking callers to call again later.
 - If you use your own message, record the greeting-only message asking callers to call again later (page 31).

- When “**Greeting only**” is selected, **GO** is displayed on the base unit.

Message alert

You can select whether or not the message indicator on the handset flashes slowly when new messages are recorded. The default setting is “**OFF**”.

Important:

- The message indicator also flashes for newly recorded voice mail messages (page 37).

Handset

- 1 **[MENU]** → **[#][3][4][0]**
- 2 **[▼]/[▲]**: Select the desired setting. →
[SAVE] → **[OFF]**

Note:

- While message alert is on, battery operating time is shortened (page 9).

Turning the call screening on/off

You can set the call screening feature “**On**” or “**OFF**”. For details, see page 31. The default setting is “**On**”.

Base unit / Handset

- 1 **[MENU]** → **[#][3][1][0]**
- 2 **[▼]/[▲]**: Select the desired setting. →
[SAVE]
- 3 Proceed with the operation for your unit.
Base unit: **[■]** (EXIT)
Handset: **[OFF]**

Voice mail service

Voice mail is an automatic answering service offered by your service provider/telephone company. After you subscribe to this service, your service provider/telephone company's voice mail system answers calls for you when you are unavailable to answer the phone or when your line is busy. Messages are recorded by your service provider/telephone company, not your telephone. Please contact your service provider/telephone company for details of this service.

Important:

- To use the voice mail service provided by your service provider/telephone company rather than the unit's answering system, turn off the answering system (page 31). For details, see page 35.

Voice mail message indication

The unit lets you know that you have new voice mail messages in the following ways:

- “**New Voice Mail**” is displayed on the display if message indication service is available.
- The message indicator on the handset flashes slowly if message alert feature is turned on (“Message alert”; page 36).

To listen to your voice mail messages, you must dial your service provider/telephone company's voice mail access number.

Note:

- If the base unit or handset still indicates there are new messages even after you have listened to all new messages, turn it off by pressing and holding **[OFF]** on the handset until a beep sounds.
- If your voice mail service uses voice mail tones and a message is over 3 minutes long, the unit may not indicate new messages.

Voice mail (VM) tone detection

Your service provider/telephone company sends special signals (sometimes called “voice mail tones” or “stutter tones”) to the unit to let you know you have new voice mail messages. If you hear a series of dial tones followed by a continuous dial tone after you lift the corded handset or press **[↶]**, you have new voice mail messages. Soon after you hang up a call or after the phone stops

ringing, your unit checks the phone line to see if new voice mail messages have been recorded. Turn this feature off when:

- You do not subscribe to voice mail service.
- Your service provider/telephone company does not send voice mail tones.
- Your phone is connected to a PBX.

If you are not sure which setting is required, contact your service provider/telephone company.

Turning VM tone detection on/off

The default setting is “On”.

Handset

- 1 **[MENU]** → **[#][3][3][2]**
- 2 **[▼]/[▲]**: Select the desired setting. → **[SAVE]** → **[OFF]**

Intercom

Intercom calls can be made:

- between the base unit and handset
- between handsets

Note:

- If you receive an outside call while talking on the intercom, you hear 2 tones.
 - To answer the call with the base unit, place the corded handset on the cradle, then lift it again. If the speakerphone is used, press **[SP-PHONE]** 2 times.
 - To answer the call with the handset, press **[OFF]**, then press **[↶]**.
- When paging unit(s), the paged unit(s) beeps for 1 minute.

Making an intercom call

Base unit

- 1 Proceed with the desired operation.
 - **When 1 handset is registered:**
Press **[INTERCOM]**.
 - **When 2 or more handsets are registered:**
Press **[INTERCOM]**.
 - To page a specific handset, enter the handset number.
 - To page all handsets, press **[0]** or wait for a few seconds.
 - Lift the corded handset if needed.
 - To stop paging, press **[INTERCOM]**.
- 2 When you finish talking, press **[INTERCOM]** or place the corded handset on the cradle.

Handset

- 1 **[MENU]** → **[⇄][2][7][4]**
- 2 To page the base unit, press **[0]**.
To page another handset, enter its extension number.
 - To stop paging, press **[OFF]**.
- 3 When you finish talking, press **[OFF]**.

Answering an intercom call

Base unit

- 1 Lift the corded handset or press **[INTERCOM]** to answer the page.
- 2 When you finish talking, place the corded handset on the cradle or press **[INTERCOM]**.

Handset

- 1 Press **[↶]** to answer the page.
- 2 When you finish talking, press **[OFF]**.

Handset locator

You can locate a misplaced handset by paging it.

- 1 **Base unit:**
[LOCATOR]
 - All registered handsets beep for 1 minute.
- 2 To stop paging:
Base unit:
Press **[LOCATOR]**.
Handset:
Press **[↶]**, then press **[OFF]**.

Transferring calls, conference calls

Outside calls can be transferred or a conference call with an outside party can be made:

- between the base unit and handset
- between 2 handsets

Base unit

- 1 Proceed with the desired operation.
 - **When 1 handset is registered:**
During an outside call, press **[INTERCOM]**.
 - **When 2 or more handsets are registered:**
During an outside call, press **[INTERCOM]**.
 - To page a specific handset, enter the handset number.
 - To page all handsets, press **[0]** or wait for a few seconds.

- 2 Wait for the paged party to answer.
 - If paged party does not answer, press **[INTERCOM]** to return to the outside call.
- 3 Proceed with the desired operation.
 - **To transfer the call:**
Place the corded handset on the cradle.
 - The outside call is being routed to the handset.
 - **To establish a conference call:**
Press **[CONF]**.
 - To leave the conference, place the corded handset on the cradle. Other parties can continue the conversation.
 - To put the outside call on hold, press **[HOLD]**. To resume the conference, press **[CONF]**.

Handset

- 1 During an outside call, press **[HOLD]** to put the call on hold.
 - To return to the outside call, press **[BACK]**.
- 2 To page the base unit, press **[0]**.
To page another handset, enter its extension number.
- 3 Wait for the paged party to answer.
 - If the paged party does not answer, press **[↶]** to return to the outside call.
- 4 Proceed with the desired operation.
 - **To transfer the call:**
Press **[OFF]**.
 - The outside call is being routed to the destination unit.
 - **To establish a conference call:**
Press **[CONF]**.
 - To leave the conference, press **[OFF]**.
The other parties can continue the conversation.
 - To put the outside call on hold, press **[HOLD]**. To resume the conference, press **[CONF]**.

Transferring a call without speaking to the other handset or base unit user

Base unit

- 1 Proceed with the desired operation.
 - **When 1 handset is registered:**
During an outside call, press **[INTERCOM]**.
 - **When 2 or more handsets are registered:**
During an outside call, press **[INTERCOM]**.
 - To page a specific handset, enter the handset number.
 - To page all handsets, press **[0]** or wait for a few seconds.
- 2 Place the corded handset on the cradle.
 - The outside call rings at the other unit.

Handset

- 1 During an outside call, press **[HOLD]** to put the call on hold.
 - To return to the outside call, press **[BACK]**.
- 2 To page the base unit, press **[0]**.
To page another handset, enter its extension number.
- 3 **[OFF]**
 - The outside call rings at the other unit.

Note for base unit and handset:

- If the other user does not answer the call within 1 minute, the call rings at your unit again.

Answering a transferred call

Base unit

Lift the corded handset or press **[SP-PHONE]** to answer the page.

Handset

Press **[↶]** to answer the page.

Note for base unit and handset:

- After the paging party disconnects, you can talk to the outside caller.

Wall mounting

Base unit

- 1 Connect the AC adaptor and telephone line cord. Tuck the telephone line cord inside the wall mounting adaptor, then push it in the direction of the arrow.

- The word "UP" should face upward.

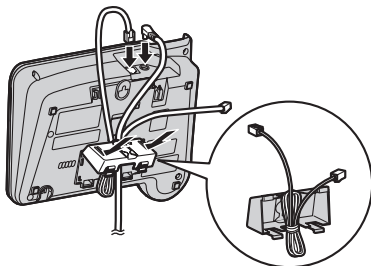

- 2 Connect the telephone line cord. Mount the unit by inserting the mounting pins into the round openings on the adaptor (for pin B, use the round cut out at the bottom of the adaptor if you are using the 4 inch phone plate), then slide the unit down to secure it. Connect the AC adaptor to power outlet (page 8).

- There are 2 common types of wall phone plates. The distance between A and B may vary depending on the size of the wall phone plate installed.

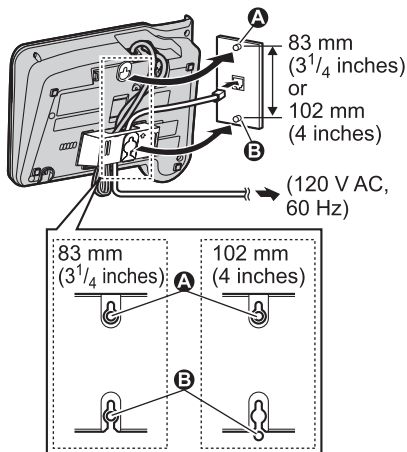

Charger

- 1 Drive the screws (not supplied) into the wall.

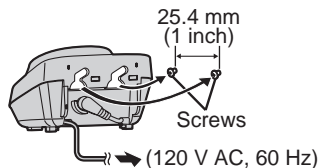

- 2 Mount the charger (1), then slide it down (2) and to the right (3) until it is secure.

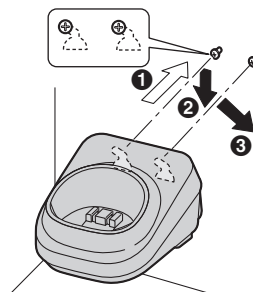

Belt clip

■ To attach

■ To remove

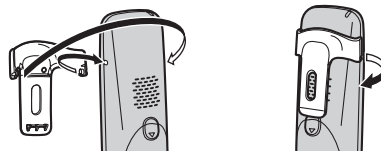

Error messages

If the unit detects a problem, one of the following messages is shown on the display.

Display message	Cause/solution
Busy	<ul style="list-style-type: none"> • The called unit is in use. • Other units are in use and the system is busy. Try again later. • The handset you are using is too far from the base unit. Move closer and try again. • The handset's registration may have been canceled. Re-register the handset (page 27).
Check tel line	<ul style="list-style-type: none"> • The supplied telephone line cord has not been connected yet or not connected properly. Check the connections (page 8).
Error!!	<ul style="list-style-type: none"> • Recording was too short. Try again.
Failed	<ul style="list-style-type: none"> • Phonebook copy failed (page 19). Confirm the other unit (the receiver) is in standby mode and try again.
Incomplete	<ul style="list-style-type: none"> • Phonebook copy is incomplete. The receiver's phonebook memory is full. Erase the unnecessary phonebook entries (page 17) from the other unit (the receiver) and try again.
Memory full	<ul style="list-style-type: none"> • The phonebook memory is full. Erase unnecessary entries (page 17). • Message memory is full. Erase unnecessary messages (page 32, 33).
Messages full	<ul style="list-style-type: none"> • Message memory is full. Erase unnecessary messages (page 32, 33).
No link. Reconnect base AC adaptor.	<ul style="list-style-type: none"> • The handset has lost communication with the base unit. Move closer to the base unit and try again. • Unplug the base unit's AC adaptor to reset the unit. Reconnect the adaptor and try again. • The handset's registration may have been canceled. Re-register the handset (page 27).
Requires subscription to Caller ID.	<ul style="list-style-type: none"> • You must subscribe to a Caller ID service. Once you receive caller information after subscribing to a Caller ID service, this message will not be displayed.
Use rechargeable battery.	<ul style="list-style-type: none"> • A wrong type of battery such as Alkaline or Manganese was inserted. Use only the rechargeable Ni-MH batteries noted on page 4, 5.

Troubleshooting

If you still have difficulties after following the instructions in this section, disconnect the base unit's AC adaptor, then reconnect the base unit's AC adaptor. Remove the batteries from the handset, and then insert the batteries into the handset again.

General use



Problem	Cause/solution
The unit does not work.	<ul style="list-style-type: none">● Make sure the batteries are installed correctly (page 8).● Fully charge the batteries (page 8).● Check the connections (page 8).● Unplug the base unit's AC adaptor to reset the unit. Reconnect the adaptor and try again.● The handset has not been registered to the base unit. Register the handset (page 27).
I cannot hear a dial tone.	<ul style="list-style-type: none">● The base unit's AC adaptor or telephone line cord is not connected. Check the connections.● If you are using a splitter to connect the unit, remove the splitter and connect the unit to the wall jack directly. If the unit operates properly, check the splitter.● Disconnect the base unit from the telephone line and connect the line to a known working telephone. If the working telephone operates properly, contact our service personnel to have the unit repaired. If the working telephone does not operate properly, contact your service provider/telephone company.
The indicator on the handset flashes slowly.	<ul style="list-style-type: none">● New messages have been recorded. Listen to the new messages (page 33).● New voice mail messages have been recorded. Listen to the new voice mail messages (page 37).

Programmable settings

Problem	Cause/solution
The display is in a language I cannot read.	<ul style="list-style-type: none">● Change the display language (page 12).
While programming, the unit starts to ring.	<ul style="list-style-type: none">● A call is being received. Answer the call and start again after hanging up.
I cannot register a handset to a base unit.	<ul style="list-style-type: none">● The maximum number of handsets (6) is already registered to the base unit. Cancel unused handset registrations from the base unit (page 27).● Place the handset and the base unit away from other electrical appliances.

Battery recharge

Problem	Cause/solution
The handset beeps and/or  flashes.	<ul style="list-style-type: none">● Battery charge is low. Fully charge the batteries (page 8).

Problem	Cause/solution
I fully charged the batteries, but  still flashes or  is displayed.	<ul style="list-style-type: none"> ● Clean the charge contacts and charge again (page 9). ● It is time to replace the batteries (page 8).
I fully charged the batteries, but the operating time seems to be shorter.	<ul style="list-style-type: none"> ● Clean the battery ends (\oplus, \ominus) and the charge contacts with a dry cloth and charge again.

Making/answering calls, intercom

Problem	Cause/solution
 is flashing.	<ul style="list-style-type: none"> ● The handset is too far from the base unit. Move closer. ● The base unit's AC adaptor is not properly connected. Reconnect AC adaptor to the base unit. ● You are using the base unit or handset in an area with high electrical interference. Re-position the base unit and use the handset away from sources of interference. ● The handset is not registered to the base unit. Register it (page 27).
Noise is heard, sound cuts in and out.	<ul style="list-style-type: none"> ● You are using the base unit or handset in an area with high electrical interference. Re-position the base unit and use the handset away from sources of interference. ● Move closer to the base unit. ● If you use a DSL/ADSL service, we recommend connecting a DSL/ADSL filter between the base unit and the telephone line jack. Contact your DSL/ADSL provider for details.
The base unit and/or handset does not ring.	<ul style="list-style-type: none"> ● The ringer volume is turned off. Adjust the ringer volume (page 14). ● Silent mode is turned on. Turn it off (page 25).
I cannot make a call.	<ul style="list-style-type: none"> ● The dialing mode may be set incorrectly. Change the setting (page 12). ● The handset is too far from the base unit. Move closer and try again.
I cannot make long distance calls.	<ul style="list-style-type: none"> ● Make sure that you have long distance service.

Caller ID

Problem	Cause/solution
Caller information is not displayed.	<ul style="list-style-type: none"> ● You must subscribe to Caller ID service. Contact your service provider/telephone company for details. ● If your unit is connected to any additional telephone equipment such as a Caller ID box or cordless telephone line jack, plug the unit directly into the wall jack. ● If you use a DSL/ADSL service, we recommend connecting a DSL/ADSL filter between the base unit and the telephone line jack. Contact your DSL/ADSL provider for details. ● The name display service may not be available in some areas. Contact your service provider/telephone company for details. ● Other telephone equipment may be interfering with this unit. Disconnect the other equipment and try again.

Useful Information

Problem	Cause/solution
Caller information is displayed late.	<ul style="list-style-type: none"> Depending on your service provider/telephone company, the unit may display the caller's information at the 2nd ring or later. Move closer to the base unit.
The caller list/incoming phone numbers are not edited automatically.	<ul style="list-style-type: none"> The Caller ID number auto edit feature is turned off. Turn it on and try again (page 29). You need to call back the edited number to activate Caller ID number auto edit.
I cannot dial the phone number edited in the caller list.	<ul style="list-style-type: none"> The phone number you dialed might have been edited incorrectly (for example, the long distance "1" or the area code is missing). Edit the phone number with another pattern (page 29).
Time on the unit has shifted.	<ul style="list-style-type: none"> Incorrect time information from incoming Caller ID changes the time. Set the time adjustment to "Manual" (off) (page 23).
The 2nd caller's information is not displayed during an outside call.	<ul style="list-style-type: none"> In order to use Caller ID, call waiting, or Call Waiting Caller ID (CWID), you must first contact your service provider/telephone company and subscribe to the desired service. After subscribing, you may need to contact your service provider/telephone company again to activate this specific service, even if you already subscribed to both Caller ID and Call Waiting with Caller ID services (CWID).

Answering system

Problem	Cause/solution
The unit does not record new messages.	<ul style="list-style-type: none"> The answering system is turned off. Turn it on (page 31). The message memory is full. Erase unnecessary messages (page 32). The recording time is set to "Greeting only". Change the setting (page 35). If you subscribe to a voice mail service, messages are recorded by your service provider/telephone company, not your telephone. Change the unit's number of rings setting or contact your service provider/telephone company (page 35).
I cannot operate the answering system.	<ul style="list-style-type: none"> Someone is using the unit. Wait for the other user to finish. A caller is leaving a message. Wait for the caller to finish. The handset is too far from the base unit. Move closer.
I cannot operate the answering system remotely.	<ul style="list-style-type: none"> You are entering the wrong remote access code. If you forgot the remote access code, enter the remote access code setting to check your current code (page 34). Press each key firmly. The answering system is turned off. Turn it on (page 35). You are using a rotary/pulse telephone. Try again using a touch-tone phone.
While recording a greeting message or listening to messages, the unit rings and the operation stops.	<ul style="list-style-type: none"> A call is being received. Answer the call and try again later.

Liquid damage

Problem	Cause/solution
Liquid or other form of moisture has entered the base unit/handset.	<ul style="list-style-type: none">● Disconnect the AC adaptor and telephone line cord from the base unit. Remove the batteries from the handset and leave to dry for at least 3 days. After the base unit/handset are completely dry, reconnect the AC adaptor and telephone line cord. Insert the batteries and charge fully before use. If the unit does not work properly, contact an authorized service center.

Caution:

- To avoid permanent damage, do not use a microwave oven to speed up the drying process.

FCC and other information

This equipment complies with Part 68 of the FCC rules and the requirements adopted by the ACTA. On the bottom of this equipment is a label that contains, among other information, a product identifier in the format US:ACJ-----.

If requested, this number must be provided to the telephone company.

- Registration No.(found on the bottom of the unit)
- Ringer Equivalence No. (REN).....0.1B
- Ringer Equivalence No. (REN: Under a power failure).....1.0B

A plug and jack used to connect this equipment to the premises wiring and telephone network must comply with the applicable FCC Part 68 rules and requirements adopted by the ACTA. A compliant telephone cord and modular plug is provided with the product. It is designed to be connected to a compatible modular jack that is also compliant.

The REN is used to determine the number of devices that may be connected to a telephone line. Excessive RENs on a telephone line may result in the devices not ringing in response to an incoming call. In most but not all areas, the sum of RENs should not exceed five (5.0). To be certain of the number of devices that may be connected to a line, as determined by the total RENs, contact the local telephone company. For products approved after July 23, 2001, the REN for the product is part of the product identifier that has the format US:AAEQ##TXXXX. The digits represented by ## are the REN without a decimal point (e.g., 03 is a REN of 0.3).

If this equipment causes harm to the telephone network, the telephone company will notify you in advance that temporary discontinuance of service may be required. But if advance notice isn't practical, the telephone company will notify the customer as soon as possible. Also, you will be advised of your right to file a complaint with the FCC if you believe it is necessary.

The telephone company may make changes in its facilities, equipment, operations or procedures that could affect the operation of the equipment. If this happens the telephone company will provide advance notice in order for you to make necessary modifications to maintain uninterrupted service.

If trouble is experienced with this equipment, for repair or warranty information, please contact a Factory Service Center or other Authorized Servicer. If the equipment is causing harm to the telephone network, the telephone company may request that you disconnect the equipment until the problem is resolved.

Connection to party line service is subject to state tariffs. Contact the state public utility commission, public service commission or corporation commission for information.

If your home has specially wired alarm equipment connected to the telephone line, ensure the installation of this equipment does not disable your alarm equipment. If you have questions about what will disable alarm equipment, consult your telephone company or a qualified installer.

This equipment is hearing aid compatible as defined by the FCC in 47 CFR Section 68.316.

When you hold the phone to your ear, noise might be heard in your Hearing Aid. Some Hearing Aids are not adequately shielded from external RF (radio frequency) energy. If noise occurs, use an optional headset accessory or the speakerphone option (if applicable) when using this phone. Consult with your audiologist or Hearing Aid manufacturer about the availability of Hearing Aids which provide adequate shielding to RF energy commonly emitted by digital devices.

WHEN PROGRAMMING EMERGENCY NUMBERS AND/OR MAKING TEST CALLS TO EMERGENCY NUMBERS:

- 1) Remain on the line and briefly explain to the dispatcher the reason for the call.
- 2) Perform such activities in the off-peak hours, such as early morning or late evenings.

This device complies with Part 15 of the FCC Rules. Operation is subject to the following two conditions: (1) This device may not cause harmful interference, and (2) this device must accept any interference received, including interference that may cause undesired operation. Privacy of communications may not be ensured when using this phone.

CAUTION:

Any changes or modifications not expressly approved by the party responsible for compliance could void the user's authority to operate this device.

NOTE:

This equipment has been tested and found to comply with the limits for a Class B digital device, pursuant to Part 15 of the FCC Rules. These limits are designed to provide reasonable protection against harmful interference in a residential installation. This equipment generates, uses, and can radiate radio

frequency energy and, if not installed and used in accordance with the instructions, may cause harmful interference to radio communications. However, there is no guarantee that interference will not occur in a particular installation. If this equipment does cause harmful interference to radio or television reception, which can be determined by turning the equipment off and on, the user is encouraged to try to correct the interference by one or more of the following measures:

- Reorient or relocate the receiving antenna.
- Increase the separation between the equipment and receiver.
- Connect the equipment into an outlet on a circuit different from that to which the receiver is connected.
- Consult the dealer or an experienced radio/TV technician for help.

Some cordless telephones operate at frequencies that may cause interference to nearby TVs and VCRs. To minimize or prevent such interference, the base of the cordless telephone should not be placed near or on top of a TV or VCR. If interference is experienced, move the cordless telephone further away from the TV or VCR. This will often reduce, or eliminate, interference.

FCC RF Exposure Warning:

- This product complies with FCC radiation exposure limits set forth for an uncontrolled environment.
- To comply with FCC RF exposure requirements, the base unit must be installed and operated 20 cm (8 inches) or more between the product and all person's body (excluding extremities of hands, wrist and feet).
- This product may not be collocated or operated in conjunction with any other antenna or transmitter.
- The handset may be carried and operated with only the specific provided belt-clip. Other non-tested belt-clips or similar body-worn accessories may not comply and must be avoided.

Notice

- FCC ID can be found inside the battery compartment or on the bottom of the units.

Compliance with TIA-1083 standard:

Telephone handsets identified with this logo have reduced noise and interference when used with T-Coil equipped hearing aids and cochlear implants.



Guía Rápida Española

Instalación

Unidad base

- Use sólo el adaptador de corriente Panasonic PQLV219 incluido.

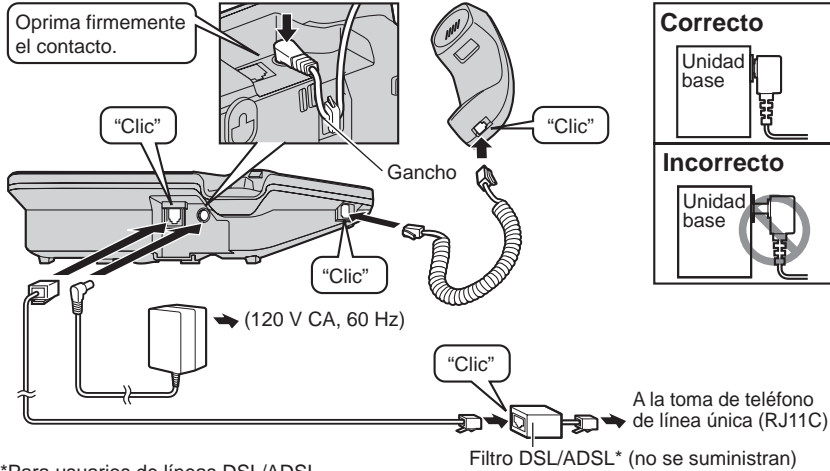

*Para usuarios de líneas DSL/ADSL

Auricular

- UTILICE SÓLO baterías de Ni-MH tamaño AAA (R03).
- NO utilice baterías Alcalinas, de Manganeseo o de Ni-Cd.
- Confirme que las polaridades estén correctas (⊕, ⊖).

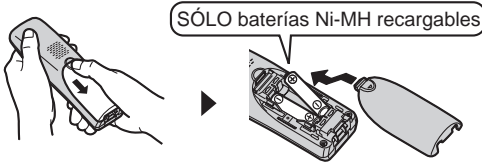

Cargador

- Use sólo el adaptador de corriente Panasonic PQLV219 incluido.

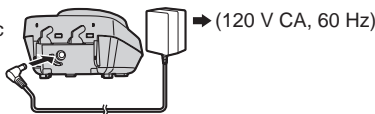

CARGUE APROXIMADAMENTE DURANTE 7 HORAS

Confirme que aparezca "Cargando".



Sugerencias de operación

Tecla navegadora/Tecla de volumen (VOL., ↵)

- Navegación por listas o elementos
Al oprimir esta tecla ([▲] o [▼]) repetidamente, puede navegar (hacia arriba o hacia abajo) por diversas listas o elementos.
- Cómo ajustar el volumen
Al oprimir esta tecla ([▲] o [▼]) repetidamente, puede ajustar el volumen (hacia arriba o hacia abajo) del receptor o el altavoz mientras habla.
- Cómo mover el cursor
Unidad base: [▲], [▼], [◀] o [▶]
Auricular: [▲] o [▼]
Al oprimir repetidamente las teclas anteriores, puede mover el cursor para editar un número o nombre.

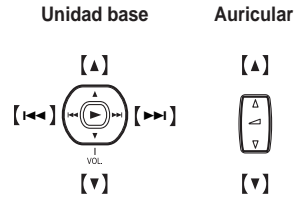

Teclas de función

Cada unidad incluye 3 teclas de función. Al oprimir una tecla de función, puede seleccionar la función que aparece directamente encima de ella en la pantalla.

[📖], [MENU], [REMR.] y otras funciones adicionales se asignan a las teclas de función. Preste atención a la pantalla para ver qué funciones están asignadas a las teclas de función durante la operación.

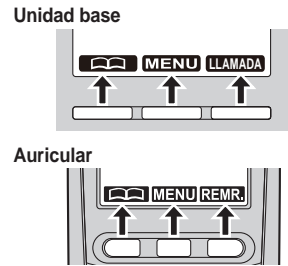

Idioma de la pantalla (Unidad base/Auricular) (predeterminado: inglés)

- 1 [MENU] → [≡][1][1][0]
- 2 [▼]/[▲]: "Español" → [GUARDA]
- 3 Continúe operando su unidad.
Unidad base: [■]
Auricular: [OFF]

Idioma de la guía de voz (Auricular) (predeterminado: inglés)

[MENU] → [≡][1][1][2] → [▼]/[▲]: Seleccione la configuración deseada. → [GUARDA] → [OFF]

Fecha y hora (Auricular)

- 1 [MENU] → [≡][1][0][1]
- 2 Introduzca el día, mes y año actuales. → [OK]
- 3 Introduzca la hora y minuto actuales (formato de reloj de 24 horas).
- 4 [GUARDA] → [OFF]

Operaciones básicas	
Cómo hacer y contestar llamadas (Unidad base/Auricular)	
Para hacer llamadas	Unidad base: Marque el número telefónico. → Levante el auricular alámbrico u oprima [SP-PHONE] . Auricular: Marque el número telefónico. → [📞]/[☎]
Para contestar llamadas	Unidad base: Levante el auricular alámbrico u oprima [SP-PHONE] . Auricular: [📞]/[☎]
Para colgar	Unidad base: Coloque el auricular alámbrico en la base. Cuando utilice el altavoz, oprima [SP-PHONE] . Auricular: [OFF]
Para ajustar el volumen del receptor o del altavoz	Oprima [▲] o [▼] repetidamente mientras habla.
Cómo hacer una llamada usando la lista de remarcación	1 Continúe operando su unidad. Unidad base: [REDIAL] Auricular: [REMR.] 2 [▼]/[▲] : Seleccione el número telefónico deseado. 3 Continúe operando su unidad. Unidad base: Levante el auricular con cable. Auricular: [📞]
Para ajustar el volumen del timbre	1 [MENU] → [⏏][1][6][0] 2 [▼]/[▲] : Seleccione el volumen deseado. → [GUARDA] 3 Continúe operando su unidad. Unidad base: [■] Auricular: [OFF]
Directorio telefónico (Unidad base/Auricular)	
Para añadir entradas	1 [📁] → [AÑAD.] 2 Introduzca el nombre de la persona (máx. 16 caracteres). → [OK] 3 Introduzca el número telefónico de la persona (máx. 24 dígitos). → [OK] 4 [▼]/[▲] : Seleccione el grupo deseado. → [SELEC.] 2 veces 5 Continúe operando su unidad. Unidad base: [■] Auricular: [OFF] • Para introducir un nombre, consulte la tabla de caracteres en las instrucciones de operación.
Para hacer llamadas	1 [📁] → [▼]/[▲] : Seleccione la entrada deseada. 2 Continúe operando su unidad. Unidad base: Levante el auricular con cable. Auricular: [📞]
Contestador de llamadas (Unidad base)	
Contestador encendido/apagado	Oprima [ANSWER ON] para encender y apagar el contestador de llamadas.
Para escuchar mensajes	[▶]

Operaciones básicas

Contestador de llamadas (Operación remota)

Puede usar un teléfono de tonos para llamar a su número telefónico desde un teléfono externo y obtener acceso a la unidad para escuchar los mensajes o cambiar la configuración del sistema contestador de llamadas. Cambie el idioma de la guía de voz a “Español” antes de operar la configuración.

- 1 Marque su número telefónico desde un teléfono de tonos.
- 2 Después de que comience el mensaje de bienvenida, introduzca su código de acceso remoto. (El código de acceso remoto predeterminado es “111”.)
- 3 Controle la unidad utilizando los comandos remotos.
 - Oprima [9] para iniciar la guía de voz.
- 4 Cuando termine, cuelgue el teléfono.

Comandos remotos

Tecla	Comando remoto
[1]	Repetir mensaje (durante la reproducción)
[2]	Avanzar al siguiente mensaje (durante la reproducción)
[4]	Reproducir mensajes nuevos
[5]	Reproducir todos los mensajes
[6]	Reproduzca el mensaje de saludo
[7]	Grabar un mensaje de saludo
[9]	Iniciar la guía de voz (se detiene la reproducción)/Detener la grabación
[0]	Apagar el sistema contestador
[*][4]	Borrar el mensaje que se está reproduciendo
[*][5]	Borrar todos los mensajes
[*][6]	Borre el mensaje de saludo (mientras lo reproduce)
[*][#]	Finalice la operación remota (o cuelgue)

Para grabar su propio mensaje (Mensaje marcador)

- 1 Después de escuchar el último mensaje, escuchará una serie de pitidos. Después de 10 segundos, sonarán 3 pitidos más.
- 2 Grabe su mensaje.
- 3 Cuando termine, cuelgue el teléfono.
 - También puede dejar un mensaje después de borrar todos los mensajes. Después del pitido largo, la unidad anunciará “No tiene mensajes”. Después de 10 segundos, sonarán 3 pitidos más. Entonces puede grabar su mensaje.
 - No puede introducir los comandos remotos mientras esté grabando su mensaje o después de hacerlo.

Preguntas frecuentes	
Pregunta	Causa y solución
¿Por qué está parpadeando Υ ?	<ul style="list-style-type: none"> ● El auricular está demasiado lejos de la unidad base. Acérquelo. ● El adaptador para corriente de la unidad base no está conectado correctamente. Conecte de nuevo el adaptador para corriente a la unidad base. ● Está usando la unidad base o el auricular en un área con mucha interferencia eléctrica. Cambie la posición de la unidad base y utilice el auricular alejado de fuentes de interferencia. ● El auricular no está registrado en la unidad base. Regístrelo.
¿Cómo se incrementa el nivel de volumen del auricular?	<ul style="list-style-type: none"> ● Oprima la tecla de navegación [▲] repetidamente mientras habla.
¿Por qué hay ruido o se corta la conversación?	<ul style="list-style-type: none"> ● Trate de reubicar la unidad base de forma que se minimice la distancia al auricular. ● Si ocurre el mismo problema aunque el auricular se encuentre enseguida de la unidad base, llame a soporte al cliente de Panasonic al 1-800-211-PANA (1-800-211-7262).
¿Es posible añadir otro auricular accesorio a mi unidad base?	<ul style="list-style-type: none"> ● Sí, puede añadir hasta 6 auriculares (incluyendo los que se venden con su unidad base) a una sola unidad base. ● Para adquirir auriculares accesorios adicionales (KX-TGA106), visite http://www.panasonic.com o llame al 1-800-332-5368. Los usuarios TTY (usuarios con impedimentos auditivos o del habla) pueden llamar al 1-866-605-1277.
¿Es posible mantener cargando las baterías todo el tiempo?	<ul style="list-style-type: none"> ● Puede dejar el auricular en el cargador el tiempo que lo desee. Esto no daña las baterías.
¿Cómo se contestan las llamadas en espera (segunda llamada)?	<ul style="list-style-type: none"> ● Oprima [CALL WAIT] cuando escuche el tono de llamada en espera.

Solución rápida de problemas

1 El auricular inalámbrico muestra:

"Sin Enlace Reconecte Adaptador"

Acérquese a la unidad base. Desconecte y después conecte correctamente el adaptador para corriente a la unidad base y a la toma de corriente alterna.

Continúa apareciendo **"Sin Enlace Reconecte Adaptador"**.

Retire las baterías del auricular durante 10 segundos, y después insértelas de nuevo.

Continúa apareciendo **"Sin Enlace Reconecte Adaptador"**.

Trate de registrar de nuevo el auricular.

El nuevo registro falló.

Es posible que su teléfono requiera servicio.
Visite nuestro sitio web para obtener más información acerca de la resolución de problemas:
<http://www.panasonic.com/help> (sólo en inglés)

Solución rápida de problemas

2 El auricular no emite ningún tono de marcación.

Vea si “Verif. Línea” aparece en la pantalla del auricular.

Aparece

No aparece

Levante el auricular del cargador.
Oprima **[*]** en el auricular, y después verifique si la pantalla muestra “Hablar”.



“Sin Enlace Reconnecte Adaptador” aparece.



“Hablar” aparece.

Verifique que el cable telefónico esté conectado correctamente a la unidad base y a la línea telefónica.

Continúa apareciendo

Trate de conectar su teléfono a la otra línea telefónica.

Continúa apareciendo

Es posible que su teléfono requiera servicio. Visite nuestro sitio web para obtener más información acerca de la resolución de problemas: <http://www.panasonic.com/help> (sólo en inglés)

Oprima **[*]**, y después verifique si se escucha el tono de marcación en el altavoz que se encuentra en la parte trasera.

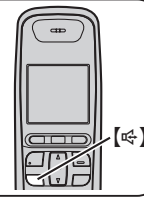

Sin tono de marcación

Pruebe el remedio para el **1** en la página anterior.

El tono de marcación se escucha.

Es posible que su teléfono requiera servicio si sólo el altavoz de la parte trasera le proporciona tono de marcación.

Cómo registrar un auricular en la unidad base

El auricular y la unidad base que se suministran ya han sido registrados. Si por alguna razón el auricular no está registrado en la unidad base, regístrelo de nuevo.

Auricular

[MENU] → [⇄][1][3][0]

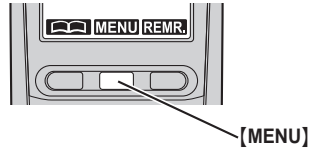

Unidad base

Oprima y mantenga oprimido [LOCATOR] durante aproximadamente 5 segundos hasta que suene el tono de registro.

- El siguiente paso debe completarse en un máximo de 90 segundos.

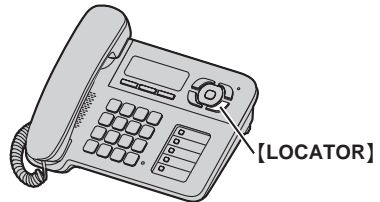

Auricular

Oprima [OK], y después espere a que se emita un pitido largo.

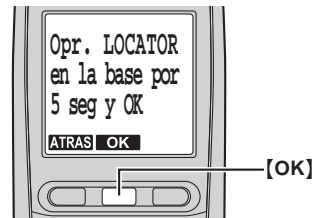

Para obtener más información acerca del registro, visite <http://www.panasonic.com/RegisterYourHandset> (sólo en inglés)

Customer services

Customer Services Directory (United States and Puerto Rico)

Obtain Product Information and Operating Assistance; locate your nearest Dealer or Service Center; purchase Parts and Accessories; or make Customer Service and Literature requests by visiting our Web Site at:

<http://www.panasonic.com/help>

or, contact us via the web at:

<http://www.panasonic.com/contactinfo>

You may also contact us directly at: 1-800-211-PANA (1-800-211-7262),
Monday - Friday 9 am to 9 pm; Saturday - Sunday 10 am to 7 pm, EST.

TTY users (hearing or speech impaired users) can call 1-877-833-8855.

Accessory Purchases (United States and Puerto Rico)

Purchase Parts, Accessories and Instruction Books online for all Panasonic Products by visiting our Web Site at:

<http://www.pstc.panasonic.com>

or, send your request by E-mail to:

npcparts@us.panasonic.com

You may also contact us directly at:
1-800-332-5368 (Phone) 1-800-237-9080 (Fax Only)
(Monday - Friday 9 am to 9 pm, EST.)

Panasonic Service and Technology Company
20421 84th Avenue South, Kent, WA 98032

(We Accept Visa, MasterCard, Discover Card, American Express, and Personal Checks.)

TTY users (hearing or speech impaired users) can call 1-866-605-1277.

Warranty (For United States and Puerto Rico)

PANASONIC CONSUMER ELECTRONICS COMPANY,
DIVISION OF PANASONIC CORPORATION OF NORTH AMERICA
One Panasonic Way, Secaucus, New Jersey 07094

Panasonic Telephone Products Limited Warranty

Limited Warranty Coverage

If your product does not work properly because of a defect in materials or workmanship, Panasonic Consumer Electronics Company (referred to as "the warrantor") will, for the length of the period indicated on the chart below, which starts with the date of original purchase ("Limited Warranty period"), at its option either (a) repair your product with new or refurbished parts, or (b) replace it with a new or a refurbished product. The decision to repair or replace will be made by the warrantor.

Parts
One (1) Year

Labor
One (1) Year

During the "Labor" Limited Warranty period there will be no charge for labor. During the "Parts" Limited Warranty period, there will be no charge for parts. You must mail-in your product prepaid during the Limited Warranty period. This Limited Warranty excludes both parts and labor for batteries, antennas, and cosmetic parts (cabinet). This Limited Warranty only applies to products purchased and serviced in the United States or Puerto Rico. This Limited Warranty is extended only to the original purchaser and only covers products purchased as new.

Ship-In Service

For assistance in the continental United States and Puerto Rico in obtaining repairs please ship the product prepaid to:

PSTC (Panasonic) Exchange Center,
4900 George McVay Drive, Suite B Door #12, McAllen, TX 78503
panacare@us.panasonic.com

When shipping the unit carefully pack in a padded shipping carton, include all accessories, and send it prepaid. Include a letter detailing the complaint, a return address and provide a day time phone number where you can be reached. P.O. Boxes are not acceptable. Keep the tracking number for your records. A copy of valid registered receipt is required under the 1 year parts and labor Limited Warranty.

For Limited Warranty service for headsets if a headset is included with this product please follow instructions above.

IF REPAIR IS NEEDED DURING THE LIMITED WARRANTY PERIOD THE PURCHASER WILL BE REQUIRED TO FURNISH A SALES RECEIPT/PROOF OF PURCHASE INDICATING DATE OF PURCHASE, AMOUNT PAID AND PLACE OF PURCHASE. CUSTOMER WILL BE CHARGED FOR THE REPAIR OF ANY UNIT RECEIVED WITHOUT SUCH PROOF OF PURCHASE.

Limited Warranty Limits And Exclusions

This Limited Warranty ONLY COVERS failures due to defects in materials or workmanship, and DOES NOT COVER normal wear and tear or cosmetic damage. The Limited Warranty ALSO DOES NOT COVER damages which occurred in shipment, or failures which are caused by products not supplied by the warrantor, or failures which result from accidents, misuse, abuse, neglect, bug infestation, mishandling, misapplication, alteration, faulty installation, set-up adjustments, misadjustment of consumer controls, improper maintenance, power line surge, lightning damage, modification, introduction of sand, humidity or liquids, commercial use such as hotel, office, restaurant, or other business or rental use of the product, or service by anyone other than a Factory Service Center or other Authorized Servicer, or damage that is attributable to acts of God.

THERE ARE NO EXPRESS WARRANTIES EXCEPT AS LISTED UNDER "LIMITED WARRANTY COVERAGE". THE WARRANTOR IS NOT LIABLE FOR INCIDENTAL OR CONSEQUENTIAL DAMAGES RESULTING FROM THE USE OF THIS PRODUCT, OR ARISING OUT OF ANY BREACH OF THIS LIMITED WARRANTY. (As examples, this excludes damages for lost time, lost calls or messages, cost of having someone remove or re-install an installed unit if applicable, travel to and from the servicer. The items listed are not exclusive, but are for illustration only.) **ALL EXPRESS AND IMPLIED WARRANTIES, INCLUDING THE WARRANTY OF MERCHANTABILITY, ARE LIMITED TO THE PERIOD OF THE LIMITED WARRANTY.**

Some states do not allow the exclusion or limitation of incidental or consequential damages, or limitations on how long an implied warranty lasts, so the exclusions may not apply to you.

This Limited Warranty gives you specific legal rights and you may also have other rights which vary from state to state. If a problem with this product develops during or after the Limited Warranty period, you may contact your dealer or Service Center. If the problem is not handled to your satisfaction, then write to the warrantor's Consumer Affairs Department at the addresses listed for the warrantor.

PARTS AND SERVICE, WHICH ARE NOT COVERED BY THIS LIMITED WARRANTY, ARE YOUR RESPONSIBILITY.

When you ship the product

- Carefully pack your unit, preferably in the original carton.
- Attach a letter, detailing the symptom.
- Send the unit to PSTC (Panasonic) Exchange Center, prepaid and adequately insured.
- Do not send your unit to Panasonic Consumer Electronics Company listed on the back cover or to executive or regional sales offices. These locations do not repair consumer products.

Index

- A** Additional handset: 27
 - Alarm: 25
 - Answering calls
 - Base unit: 14
 - Handset: 14
 - Answering system
 - Call screening: 31
 - Erasing messages: 32, 33, 34
 - Greeting only: 35
 - Listening to messages: 32, 33, 34
 - Number of rings: 35
 - Recording time: 35
 - Remote access code: 34
 - Remote operation: 34
 - Ring count: 35
 - Toll saver: 35
 - Turning on/off: 31, 35
 - Auto talk: 14
- B** Battery: 8, 9
 - Belt clip: 40
- C** Call block: 26
 - Caller ID number auto edit: 29
 - Caller ID service: 28
 - Caller list: 28
 - Caller list edit: 29
 - Call share: 15
 - Call waiting: 15
 - Call Waiting Caller ID: 15
 - Chain dial: 18
 - CID (Caller ID): 28
 - Conference calls: 38
 - Customer support: 22
- D** Date and time: 12
 - Dialing mode: 12
 - Direct commands: 22
 - Display
 - Contrast: 22
 - Language: 12
- E** Error messages: 41
- F** Flash: 15, 23
- G** Greeting message: 31
 - Group ringer tone: 28
- H** Handset
 - Deregistration: 27
 - Locator: 38
 - Registration: 27
 - Hold: 14
- I** Intercom: 38
- K** Key tone: 22
- L** Line mode: 23
- M** Making calls
 - Base unit: 13
 - Handset: 13
 - Memory full: 17, 32, 33, 41
 - Messages full: 31, 32, 33, 41
 - Missed calls: 28
 - Mute: 15
- P** Pause: 13
 - Phonebook: 16
 - Power failure: 9
- R** Redialing: 13
 - Ringer tone: 23
 - Ringer volume: 14
 - Rotary/pulse service: 15
- S** Silent mode: 25
 - Speed dial: 18
 - SP-PHONE (Speakerphone): 13
- T** Temporary tone dialing: 15
 - Time adjustment: 23
 - Transferring calls: 38
 - Troubleshooting: 42
 - TTY: 56
- V** VM (Voice mail): 37
 - Voice guidance language: 12
 - Voice mail: 35, 37
 - Volume
 - Receiver: 13
 - Ringer (Base unit): 23
 - Ringer (Handset): 14, 23
 - Speaker: 13
- W** Wall mounting: 40

IMPORTANT!

If your product is not working properly. . .

1. Read these **Operating Instructions**
2. Visit our website: <http://www.panasonic.com/help>
 - FAQs and troubleshooting hints are available.
3. Contact us via the web at: <http://www.panasonic.com/contactinfo>
4. Call us at: **1-800-211-PANA (1-800-211-7262)**
 - Monday - Friday 9:00am - 9:00pm (EST),
Saturday/Sunday 10:00am - 7:00pm (EST)

To order replacement batteries, call **1-800-332-5368** or visit
<http://www.panasonic.com/batterystore>

For your future reference

We recommend keeping a record of the following information to assist with any repair under warranty.

Serial No.

Date of purchase

(found on the bottom of the base unit)

Name and address of dealer

Attach your purchase receipt here.

Panasonic Consumer Electronics Company,
Division of Panasonic Corporation of North America
One Panasonic Way, Secaucus, New Jersey 07094

Copyright:

This material is copyrighted by Panasonic Communications Co., Ltd., and may be reproduced for internal use only. All other reproduction, in whole or in part, is prohibited without the written consent of Panasonic Communications Co., Ltd.

© Panasonic Communications Co., Ltd. 2009



TG1061

PNQX1800YA CC1208SY1019