

Kenmore Ultra Wash Dishwasher

SEARS Use & Care Guide

MODELS 15821, 15825, 15828

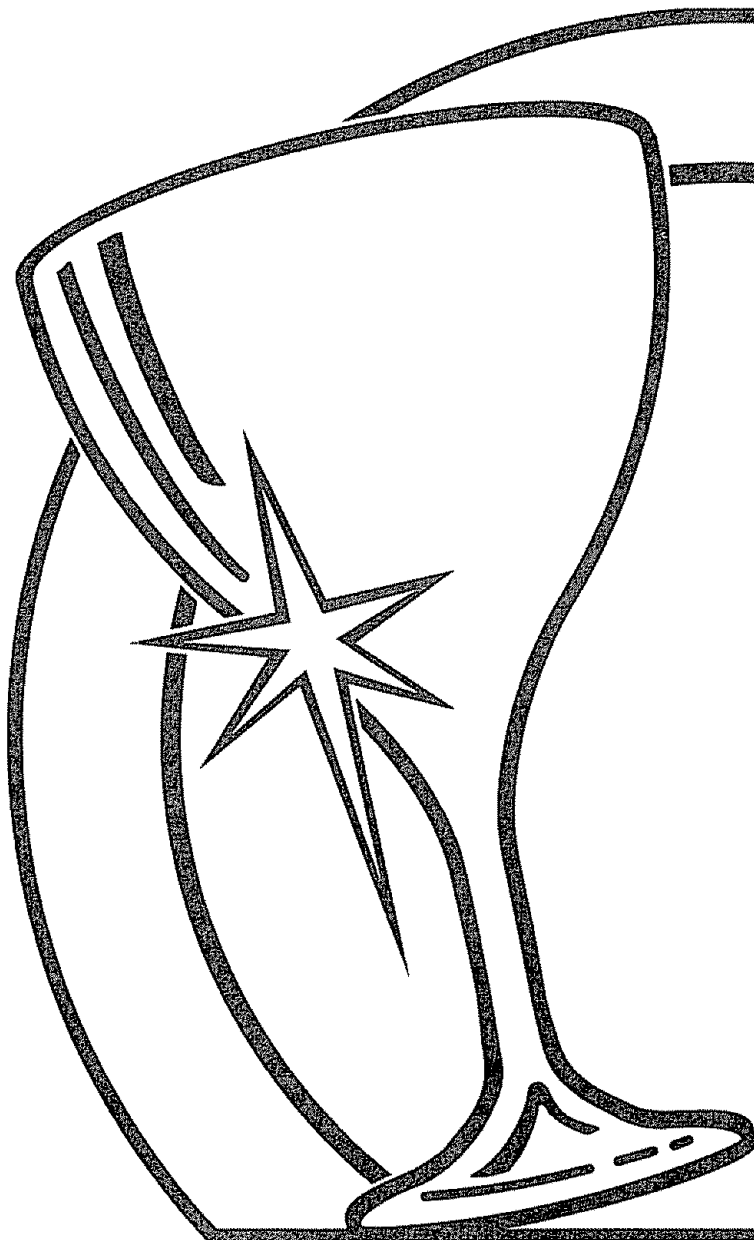

Table of Contents	2
Dishwasher Safety	3
America's Cleanest Dishes	4
Parts and Features	5
Quick Reference Guide	6
Your Part in Cleaning Dishes	11
Loading Your Dishwasher	13
Caring for Your Dishwasher	19
Solutions to Common Problems ...	23
Troubleshooting	26
Sears Repair Services	27
Warranty	28

Table of Contents

Dishwasher Safety	3	Loading Your Dishwasher	
America's Cleanest Dishes		Preparing to load your dishwasher	13
How the ULTRA WASH™ System works	4	Loading the top rack	13
Parts and Features	5	Removing the top rack	15
Quick Reference Guide	6-10	Loading the bottom rack	15
Before starting your dishwasher	6	Loading the silverware basket	17
Starting your dishwasher for everyday loads	7	Quiet operating tips	17
Cycles	8	Tips for washing special items	18
Changing a cycle	9	Caring for Your Dishwasher	
Options	9	Cleaning your dishwasher	19
Signal lights	10	Moving or winterizing your dishwasher	19
Delay Wash pad	10	Energy saving tips	20
Diagnostic display	10	Changing door color panel	20
Your Part In Cleaning Dishes		Solutions to Common Problems	23
Using the detergent dispenser	11	Troubleshooting	26
Using the rinse agent dispenser	12	Sears Repair Services	27
Water temperature tips	12	Warranty	28

Please read and save these instructions

Thank you for selecting this KENMORE dishwasher. To ensure that you will enjoy many years of trouble-free operation, we developed this Use and Care Guide. Please take a few minutes to read this book. It contains information that will help you get the best, safest, and most economical results from your dishwasher.

Also, please fill in the spaces below. You can find this information on the model and serial number label (see diagram on page 5). Keep this book and the sales slip together in a safe place for future reference.

Model Number _____

Serial Number _____

Purchase Date _____

Dishwasher Safety

Your safety and the safety of others is very important.

We have provided many important safety messages in this manual and on your appliance. Always read and obey all safety messages.



This is the safety alert symbol.

This symbol alerts you to hazards that can kill or hurt you and others.

All safety messages will be preceded by the safety alert symbol and the word "DANGER" or "WARNING." These words mean:

⚠ DANGER

You will be killed or seriously injured if you don't follow instructions.

⚠ WARNING

You can be killed or seriously injured if you don't follow instructions.

All safety messages will identify the hazard, tell you how to reduce the chance of injury, and tell you what can happen if the instructions are not followed.

IMPORTANT SAFETY INSTRUCTIONS

WARNING – When using the dishwasher, follow basic precautions, including the following:

- Read all instructions before using the dishwasher.
- Use the dishwasher only for its intended function.
- Use only detergents or rinse agents recommended for use in a dishwasher and keep them out of the reach of children.
- When loading items to be washed:
 - 1) Locate sharp items so that they are not likely to damage the door seal; and
 - 2) Load sharp knives with the handles up to reduce the risk of cut-type injuries.
- Do not wash plastic items unless they are marked "dishwasher safe" or the equivalent. For plastic items not so marked, check the manufacturer's recommendations.
- Do not touch the heating element during or immediately after use.
- Do not operate the dishwasher unless all enclosure panels are properly in place.
- Do not tamper with controls.
- Do not abuse, sit on, or stand on the door or dish racks of the dishwasher.
- To reduce the risk of injury, do not allow children to play in or on the dishwasher.
- Under certain conditions, hydrogen gas may be produced in a hot water system that has not been used for two weeks or more. **HYDROGEN GAS IS EXPLOSIVE.** If the hot water system has not been used for such a period, before using the dishwasher turn on all hot water faucets and let the water flow from each for several minutes. This will release any accumulated hydrogen gas. As the gas is flammable, do not smoke or use an open flame during this time.
- Remove the door to the washing compartment when removing an old dishwasher from service or discarding it.

– SAVE THESE INSTRUCTIONS –

America's Cleanest Dishes

How the ULTRA WASH™ System works

The ULTRA WASH Soil Removal System uses a heavy duty grinder as a food disposer to grind large food particles. All you need to do is remove bones, large chunks, or burned-on food. Any remaining food will be ground up and disposed of by the ULTRA WASH System. You can put any dishwasher-safe item in the dishwasher and expect sparkling clean results.

Washing

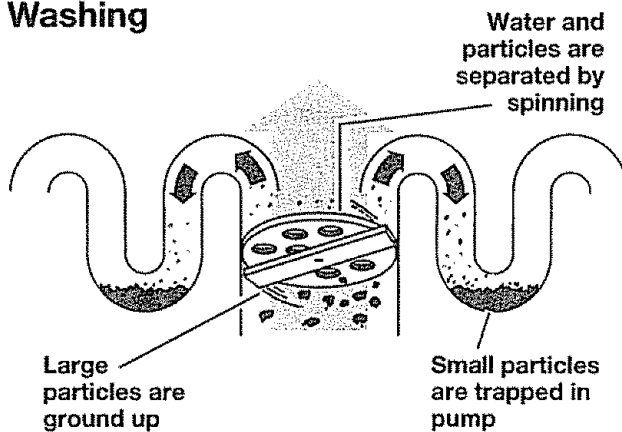

Draining

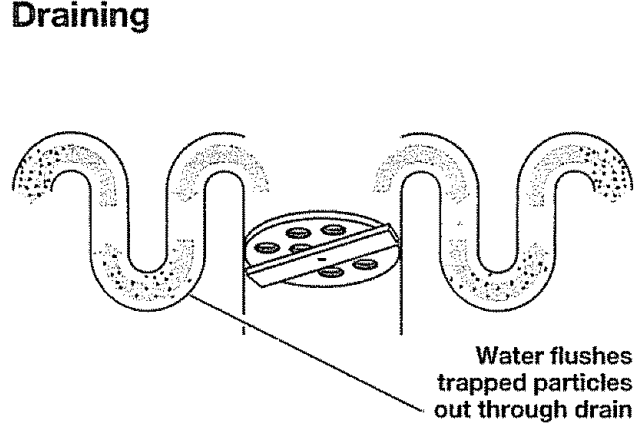

- Hot water fills the dishwasher to a level near the bottom of the overflow protector.
- Detergent is added at the correct times from the detergent dispenser, and hot water is pumped through the ULTRA WASH pump.
- Food particles are removed from dishes, pots and pans, tableware, and cutlery as the dishwasher sprays a mixture of hot water and detergent through two spray arms against their soiled surfaces.
- Water is pumped again through the ULTRA WASH pump to remove soil particles from the water.

- Soil in the ULTRA WASH Soil Removal System is disposed down the drain with the wash water.
- Final rinse water is heated, and a rinse agent is added to prepare the dishes for drying.
- Fresh, hot water enters the dishwasher, sprays on the dishes to rinse them, and rinse water is pumped through the ULTRA WASH System to remove any remaining soil.
- The rinse ends with the soil that is held in the ULTRA WASH Soil Removal System being disposed down the drain with rinse water.

Parts and Features

Use this section to become familiar with the location and appearance of all parts and features. To help you find information on specific parts or features quickly, page references are included.

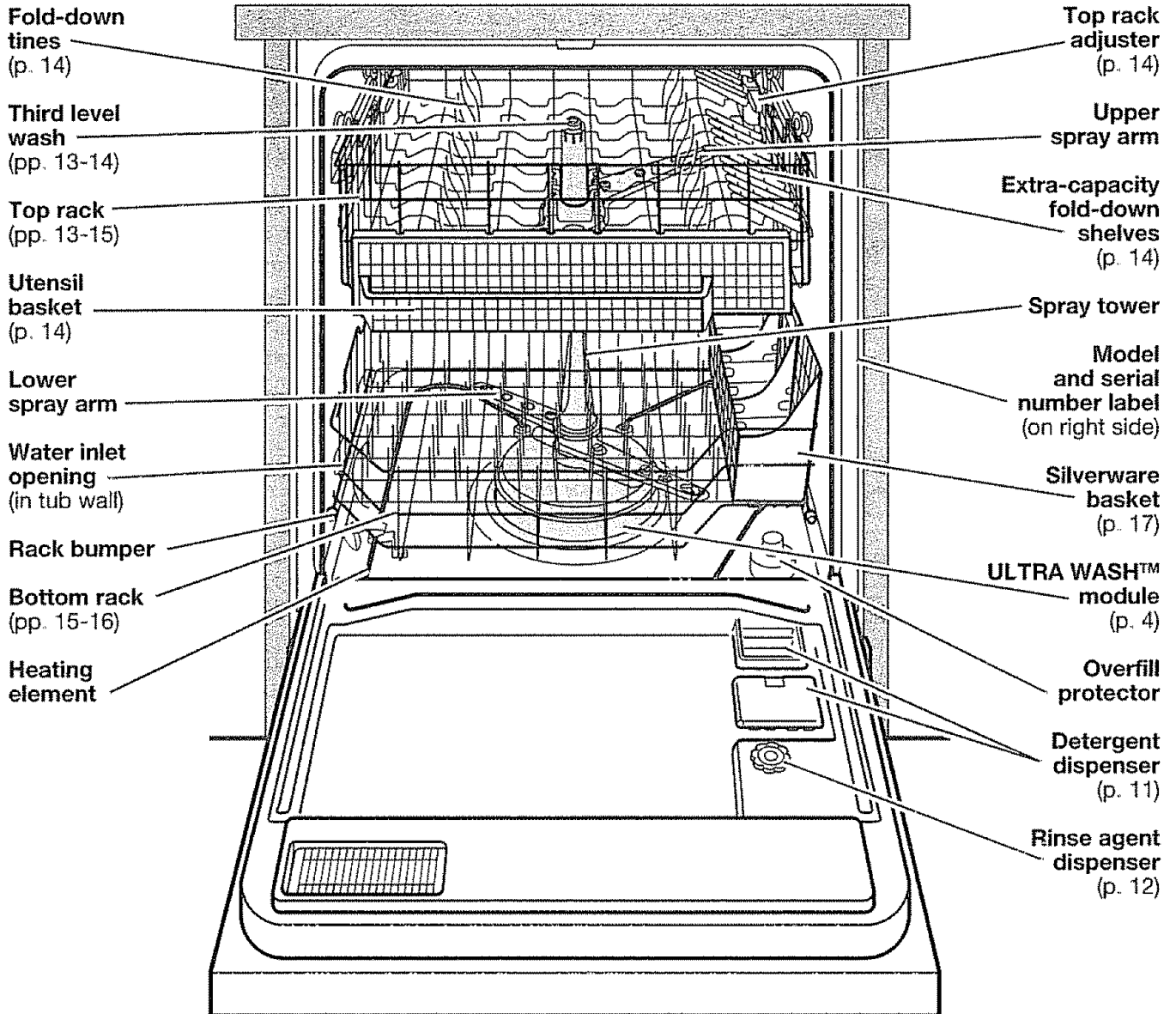

Quick Reference Guide

Before starting your dishwasher

⚠ WARNING

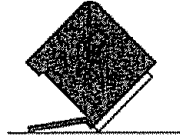

Tip Over Hazard

Do not use dishwasher until completely installed.

Do not push down on open door.

Doing so can result in serious injury or cuts.

⚠ WARNING



Electrical Shock Hazard

Electrically ground dishwasher.

Connect ground wire to green ground connector in terminal box.

Do not use an extension cord.

Failure to do so can result in death, fire, or electrical shock.

GROUNDING INSTRUCTIONS

- For a grounded, cord connected dishwasher:
The dishwasher must be grounded. In the event of a malfunction or breakdown, grounding will reduce the risk of electric shock by providing a path of least resistance for electric current. The dishwasher is equipped with a cord having an equipment-grounding conductor and a grounding plug. The plug must be plugged into an appropriate outlet that is installed and grounded in accordance with all local codes and ordinances.

WARNING – Improper connection of the equipment-grounding conductor can result in a risk of electric shock. Check with a qualified electrician or service representative if you are in doubt whether the dishwasher is properly grounded. Do not modify the plug provided with the dishwasher; if it will not fit the outlet, have a proper outlet installed by a qualified electrician.

- For a permanently connected dishwasher:
The dishwasher must be connected to a grounded metal, permanent wiring system, or an equipment-grounding conductor must be run with the circuit conductors and connected to the equipment-grounding terminal or lead on the dishwasher.

– SAVE THESE INSTRUCTIONS –

Control Panel

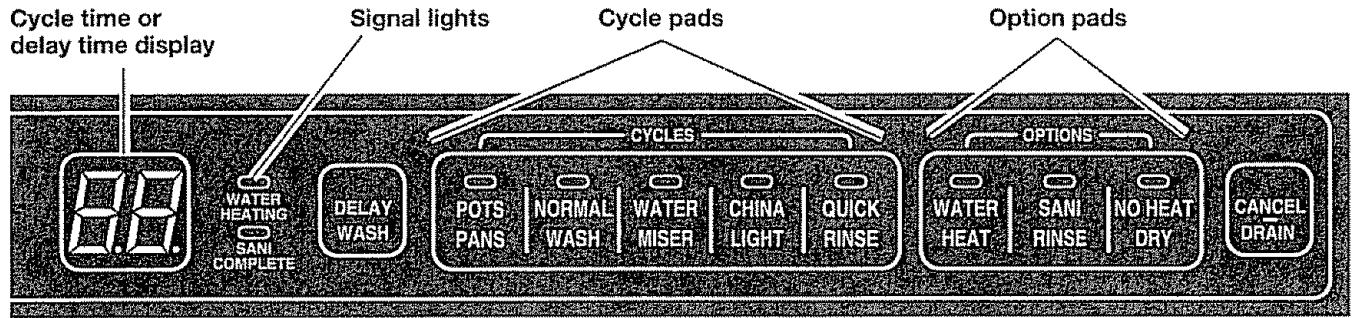

Starting your dishwasher for everyday loads

NOTE: PF will show on the display the first time your dishwasher is connected to electricity or when electricity returns after prolonged failure. To clear the display, press the Cancel/Drain pad.

1. The ULTRA WASH™ Soil Removal System is designed to remove food particles from the wash and rinse water. You only need to remove large chunks and bones.
2. Properly load the top rack, bottom rack, and silverware basket. See pages 13-17.
3. Spin both spray arms with both racks pushed back into place to make sure nothing prevents arms from turning freely.
4. Add detergent. See page 11.
5. Check the rinse agent dispenser. See page 12.
6. Push door firmly when closing and it will automatically latch.
7. Run hot water at the sink nearest to the dishwasher until water is hot. Turn off water.

(See pages 8-9 for additional cycle and option descriptions.)

Use Normal Wash to wash dishes now:

Press



You will see

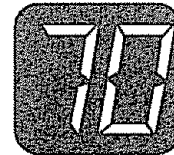

(cycle time)

Use Quick Rinse now if you plan to wash dishes later:

Press



You will see

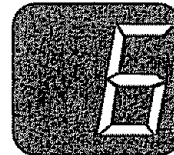

(cycle time)

Then use Water Miser when you wash prerinsed dishes:

Press





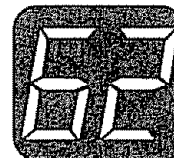



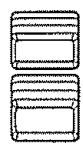

You will see

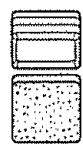

(cycle time)

Cycles

CYCLE	A "✓" shows what each cycle includes.						CYCLE TIME* (MINUTES)	Detergent cups
	WASH	RINSE	MAIN WASH	RINSE	DRY			
QUICK RINSE 				✓			6	 Fill 0 Detergent cups
For rinsing dishes that will be washed later.								
CHINA LIGHT 			✓	✓ ^{††}	✓		62*	 Fill 1 Detergent cup
A light wash and gentle dry for china and crystal. If you have not selected No Heat Dry, the heating element cycles on and off during the drying part of the cycle. • Water automatically heats to 135°F (57°C) in the final rinse (marked ††).								
WATER MISER 			✓ [†]	✓ ^{††}	✓		62*	 Fill 1 Detergent cup
For prerinsed and lightly soiled dishes. Saves energy by using less hot water than Normal Wash cycle. • Select the Water Heat option to heat water to 135°F (57°C) in the main wash (marked †). • Water automatically heats to 135°F (57°C) in the final rinse (marked ††).								
NORMAL WASH 	✓		✓ [†]	✓ ^{††}	✓		70*	 Fill 2 Detergent cups
For everyday heavily soiled dishes. (The Energy Guide label is based on this cycle.) • Select the Water Heat option to heat water to 135°F (57°C) in the main wash (marked †). • Water automatically heats to 135°F (57°C) in the final rinse (marked ††).								
POTS PANS 	✓ ^{††}	✓	✓ ^{††}	✓ ^{††}	✓		86*	 Fill 2 Detergent cups
For cleaning dishes, and pots and pans with cooked-on or baked-on foods. • Water automatically heats to 135°F (57°C) in the wash, main wash, and final rinse (marked ††).								
* Cycle time includes dry time and may be longer depending on the temperature of water entering the dishwasher. The cooler the water, the longer the cycle time. If the water is already hot enough, the cycle times will be as shown. † † The electronic time display will pause while water is being heated								

Changing a cycle

Cancel/Drain

To change a cycle:

- During the first two minutes of operation while filling, simply select a new cycle.



OR

- After the first two minutes, press Cancel/Drain, wait two minutes, and select a new cycle. (Remember to add detergent if the dishwasher has already gone through the wash portion of the cycle.)

Options

Automatic Preprogramming

Any option can be automatically preprogrammed by pressing and holding the desired option pad. The pad will beep when you first press it, then beep a second time while you continue to press it. Release the pad after the second beep. The option will automatically be chosen whenever you select a cycle with which the option normally works. To turn off a preprogrammed option, press and release the option pad, then press and hold the option pad until the pad beeps a second time.

Water Heat

Use this option when washing heavily soiled dishes.



When you select Water Heat, the main wash will delay until the water heats to 135°F (57°C). As water heats, washing action will continue and the Water Heat light will glow; however, the electronic time display will pause.

- The Pots Pans cycle automatically uses Water Heat.
- Selecting the Water Heat option will not cause water to be heated during Quick Rinse or China Light cycles.

No Heat Dry

Use this option to dry dishes in room temperature air and save energy. When you select No Heat Dry, drying will take longer than heat drying, and water spotting can occur. It is important to use rinse agent when selecting this option.



- Use this option when you do not plan to unload the dishwasher for several hours.

Cancel/Drain

When this option is selected, the dishwasher will stop and any water in it will drain. Draining will take about two minutes. When draining is complete, all signals will turn off. You may then select a new cycle, if you wish.



Sani Rinse

Sani Rinse is available in Pots Pans, Normal Wash, and Water Miser cycles. When this option is selected, water for the final rinse is heated to ensure a high temperature, sanitary rinse. The cycle time will be extended until the water reaches the proper temperature. The Water Heat light glows and washing action continues while the water heats. The Sani Complete light glows at the end of the cycle indicating a high temperature, sanitary rinse was completed.

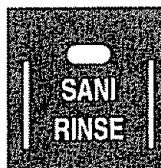

NOTE: A flashing Sani Complete light indicates that a high temperature, sanitary rinse was not completed. The Sani Complete light will flash at the end of the cycle if the dishwasher door is opened, power fails, or water heating is not completed during the final rinse. You may need to turn your water heater temperature up so water is at least 120°F (49°C) as it enters the dishwasher.

Signal Lights

Water Heating

The Water Heating light glows to indicate the dishwasher is heating water to the proper dishwashing temperature if your household water is not hot enough.

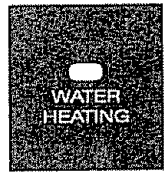

NOTE: The electronic time display will pause while this occurs.

- All cycles (except Quick Rinse) automatically heat water during the final rinse.
- Water heating is automatic in the wash portions of the Pots Pans cycle.
- Water heating is an option in the main wash of the Normal Wash and Water Miser cycles.

Sani Complete

The Sani Complete light glows at the end of the cycle indicating a high temperature, sanitary rinse was completed.



NOTE: A flashing Sani Complete light indicates that a high temperature, sanitary rinse was not completed. The Sani Complete light will flash at the end of the cycle if the dishwasher door is opened, power fails, or water heating is not completed during the final rinse. You may need to turn your water heater temperature up so water is at least 120°F (49°C) as it enters the dishwasher.

Delay Wash pad

Use Delay Wash when you want a cycle to start later. Delay Wash can be set to start the dishwasher during times when off-peak utility rates are in effect or when you are away from home.



1. Close the door firmly until you hear it latch.
2. Press the Delay Wash pad and one hour of delay

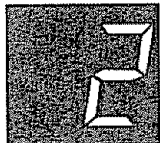

will show on the display. Each time you press the Delay Wash pad, the delay time will increase in one-hour settings. The longest delay setting is 9 hours.

Hours of delay

3. Press pads for desired cycle and options.

4. The display will show the number of hours remaining until washing begins. The display will show hours only: If the display shows 2, there is between 1 hour and 1 hour 59 minutes remaining.
5. When the hours of delay you have set have elapsed, the dishwasher will start the cycle selected in Step 3. The wash time will count down the minutes remaining in the cycle to 0.

If you wish to put more dishes in the dishwasher while it is in the delay mode, be sure to latch the door after adding them. The timer will not advance unless the door is latched. To cancel Delay Wash, press the Cancel/Drain pad.

Diagnostic display

In addition to showing remaining delay or cycle time, the digital display will show a code indicating the dishwasher's condition:

- PF will appear in the display the first time the dishwasher is connected to the electrical supply after installation. This display also indicates there was a power failure. Press Cancel/Drain to drain the dishwasher. If there is no water in the dishwasher, press Cancel/Drain a second time. Reselect a cycle to restart the dishwasher.



- CC will appear on the display when the dishes are washed and the cycle completed. Opening the door or pressing the Cancel/Drain pad will clear the display.



- E2 will appear in the display if the selector pads are stuck. Press Cancel/Drain to release the controls, or run your fingers across the pads to free them up. If E2 remains in the display, call for service.



Your Part in Cleaning Dishes

Operating your dishwasher properly enables you to obtain the best possible results. This section explains proper dishwasher operation.

Using the detergent dispenser

- **Use automatic dishwashing detergent only.**
Other detergents are too mild and much too sudsy.
- Add detergent just before starting cycle.
- Store tightly closed detergent in a cool, dry place.
Fresh automatic dishwasher detergent results in better cleaning.

Filling the detergent dispenser

The detergent dispenser has one section with a cover and one without. Push cover down firmly until it latches. Detergent in the open section falls into the dishwasher when closing the door. The covered section opens automatically for the main wash.

NOTE: It is normal for cover to open partially when dispensing detergent.

How much detergent to use

- The amount of detergent to use depends on the hardness of your water and the type of detergent. If you use too little, dishes won't be clean. If you use too much in soft water, glassware will etch.
- Different brands of dishwasher detergent have different amounts of phosphorus for softening water. If you have hard water and use a detergent with a phosphorous content of less than 8.7%, you may need to use more detergent, or use a detergent with a phosphorous content higher than 8.7%.
- Find out your water's hardness by asking your local water department or water softener company.

NOTE: Fill amounts shown are for standard powdered detergent. Amounts may vary if you use liquid or concentrated powdered detergent. Follow manufacturer's directions when using liquid dishwasher detergent or concentrated powdered detergent.

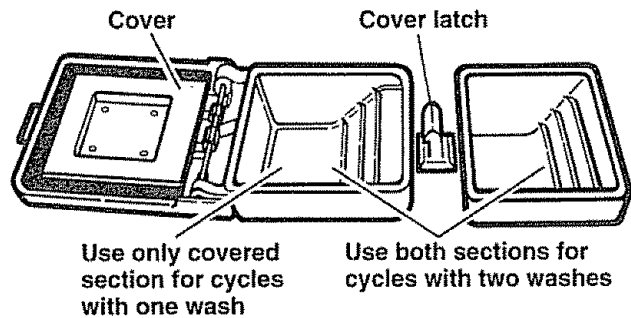

WATER TYPE	WHERE TO FILL	
Hard 8+ grains per gallon 136+ parts per million	Top of 3rd step (3 tbs.)	
Medium 5-7 grains per gallon 85-119 parts per million	Top of 2nd step (2 tbs.)	
Soft 0-4 grains per gallon 0-68 parts per million	Top of 1st step (1 tbs.)	

Using the rinse agent dispenser

Keep the rinse agent dispenser filled with a liquid rinse agent. A rinse agent greatly improves dish drying by helping water flow off them during the last rinse. A rinse agent also keeps water from forming droplets and drying as spots or streaks.

A small amount of rinse agent automatically releases into the rinse water during the final rinse of each cycle. For best drying results, check dispenser periodically to see if it needs filling.

To check dispenser:

- Check center of fill indicator cap. Clear means it needs filling.

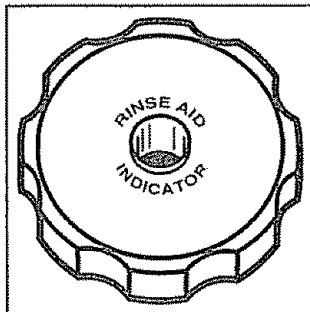

- Or remove fill indicator cap. An "E" is visible at the bottom of the dispenser when empty.

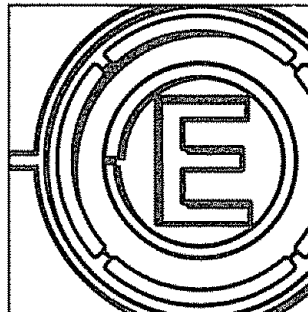

To fill dispenser:

The rinse agent dispenser holds 6 ounces (175 mL). Under normal conditions, this lasts about 3 months.

1. Open dishwasher door completely.
2. Remove fill indicator cap.
3. Add rinse agent. Fill to smallest opening in lower part of dispenser only. Overfilling may cause rinse agent to leak out. This will not harm the dishwasher, but could cause oversudsing.
4. Clean up any spilled rinse agent with a damp cloth.
5. Replace fill indicator cap. Keep it closed tightly.

NOTE: You do not have to wait until the dispenser is empty before refilling, but do not overfill it. Your dishwasher is designed to use a liquid rinse agent. You do not need to use a solid or bar-type rinse agent.

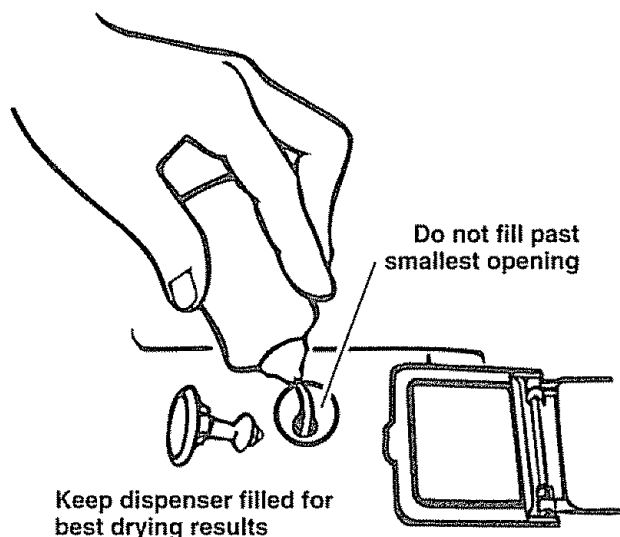

Water temperature tips

Hot water dissolves and activates the dishwashing detergent. Hot water also dissolves grease on dishes and helps dry glasses spot-free. Use the Water Heat option, if available, if you keep your water heater at a low setting. For best dishwashing results, water must be at least 120°F (49°C) as it enters the dishwasher.

NOTE: The time showing on the electronic display will pause while water is heating. For more information, see "Dishwasher seems to run too long" on page 26.

To check water temperature:

1. Run hot water at the faucet closest to your dishwasher. Let the water run for at least 1 minute.
2. Measure the water temperature with a candy or meat thermometer. Put the thermometer in the running stream of water.



3. If the water temperature at the faucet is below 120°F (49°C), have a qualified person raise the water heater's thermostat setting.

Loading Your Dishwasher

This section tells you how to load your dishwasher properly for the best washing and rinsing results.

Preparing to load your dishwasher

- To save water and energy, do not rinse dishes before putting them into the dishwasher.
 - Remove large pieces of food, bones, and other hard items. The ULTRA WASH™ module will remove food particles from the water. The module contains a chopping device which will reduce the size of food items.
- NOTE:** If hard items such as fruit seeds, nuts, and egg shells enter the ULTRA WASH module, you might hear chopping, grinding, crunching, or buzzing sounds. Those sounds are normal when hard items enter the module. **Do not** let metallic items (such as pot handle screws) get into the ULTRA WASH module. This could damage the ULTRA WASH module.
- Foods like eggs, rice, pasta, spinach, and cooked cereals may be hard to remove if they are left to dry over a period of time. Run a Quick Rinse cycle to keep dishes moist if you do not plan to wash them soon.
 - Load dishes so soiled surfaces face the rotating spray arms.
 - Load dishes so they are not stacked or overlapping, if possible. It is important for the water spray to reach all soiled surfaces for best washing. For best drying, water must be able to drain from all surfaces.

Loading the top rack

The top rack is designed for cups, glasses, and smaller items. Do not cover the third level wash when loading the top rack.

- Place so open ends face down for cleaning and draining.
- Load glasses in top rack only – bottom rack is not designed for glasses. Damage may occur.
- Place cups and glasses in the rows between prongs. Placing them over the prongs can lead to breakage.
- Secure lightweight items.
- China, crystal, and other delicate items must not touch each other during dishwasher operation. Damage may occur.

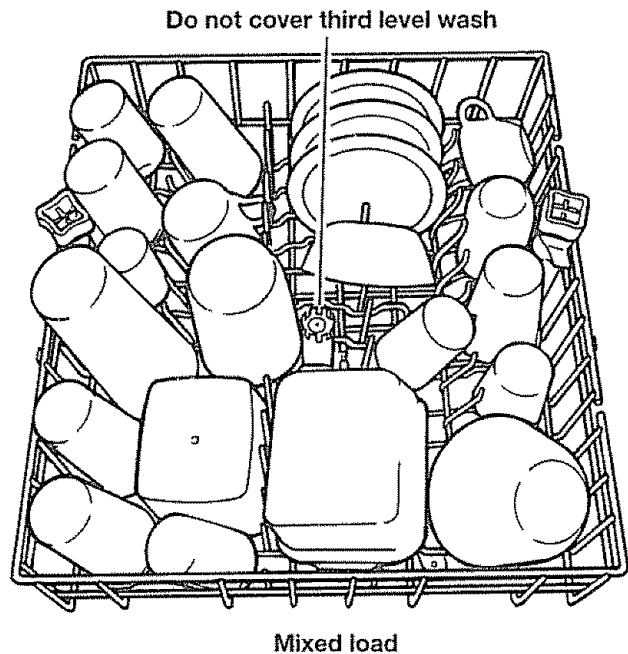

continued on next page

Loading the top rack (cont.)

- Load plastic items in the top rack only. Only plastic items marked "dishwasher safe" are recommended.
- Load plastic items so the force of the spray does not move them during the cycle.
- To avoid chipping, do not let stemware touch other items.
- Small bowls, pans, and other utensils can be placed in the top rack.



Cup and glass load

Adjustable top rack

You can raise or lower the rack to fit tall items in either the top or bottom rack. The top rack does not have to be level.

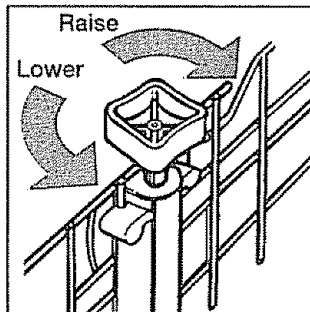

- Turn knob clockwise to raise one side of the rack.
- Turn knob counter-clockwise to lower one side of the rack.

Extra-capacity fold-down shelves

Fold down the extra shelves on the right side of the top rack over short items (cups, juice glasses, cereal bowls, etc.) to hold extra items. Adjust rack height if necessary (see "Adjustable top rack" left).

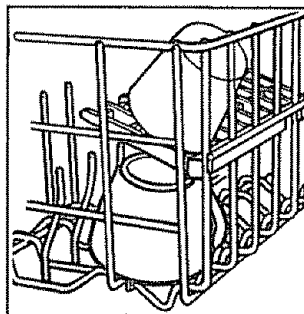

Utensil basket

Use this convenient basket to hold spatulas, wooden spoons, and similar items. It hooks over the front of the top rack and is not removable.

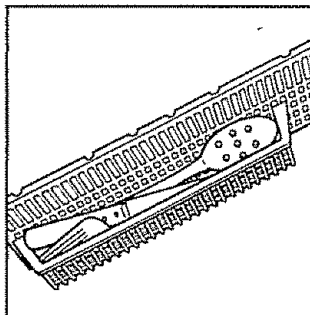

Fold-down tines

Fold the tines in the top rack all the way down to accommodate larger items.

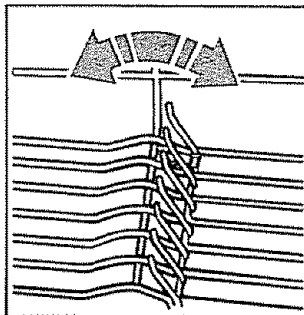

Removing the top rack

Remove the top rack when you need more space to load tall items in the bottom rack.

To remove the top rack:

1. Remove all loaded items from top rack.
2. Gently pull out and up on left end cap tab.
3. Slide end cap up and off of guide rail.
4. Repeat Steps 1 and 2 to remove right end cap.
5. Hold top rack with both hands and pull rack forward until guide wheels are out of guide rail.

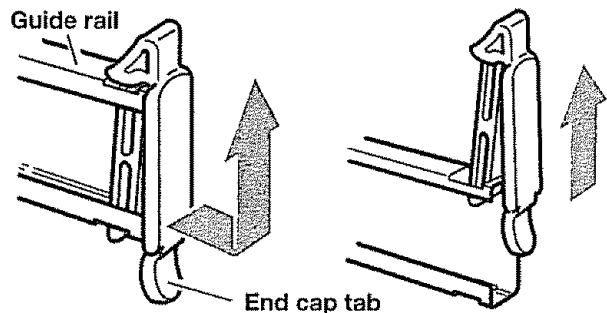

To replace the top rack:

1. Position top rack with the rear guide wheels next to guide rails.
2. Slide guide wheels of rack into the guide rails. Push top rack into dishwasher.
3. Slide end caps into the holes in guide rails. You will hear the end cap "snap" into place.

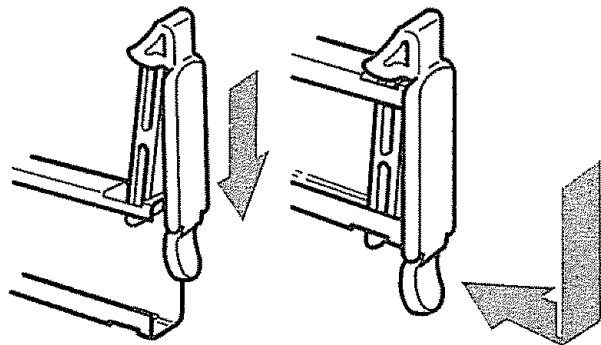

Loading the bottom rack

Items with cooked-on or dried-on food should be loaded in the bottom rack, with soiled surfaces facing inward to the spray.

NOTE: The top rack can be removed if more space is needed for tall items in the bottom rack. See "Removing the top rack."

- Do not load glasses, cups, or plastic items in the bottom rack.
- Load plates, soup bowls, etc., between prongs and facing inward to the spray.
- Overlap edges of plates for large loads.
- Secure heavily soiled cookware face down in the rack.

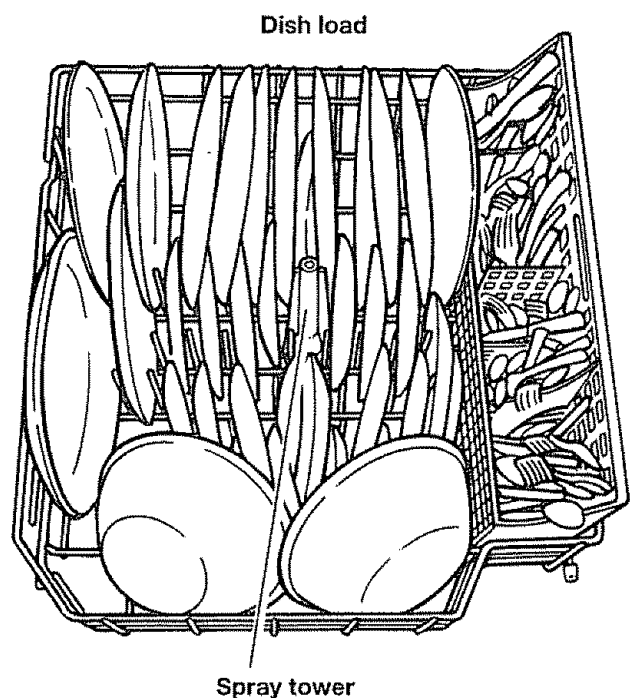

continued on next page

Loading the bottom rack (cont.)

- Load items so they do not block or cover the spray tower.
- Make sure pot handles and other items do not stop rotation of the lower spray arm. The spray arm must move freely.
- When the bottom rack is removed, replace with bumpers in front.

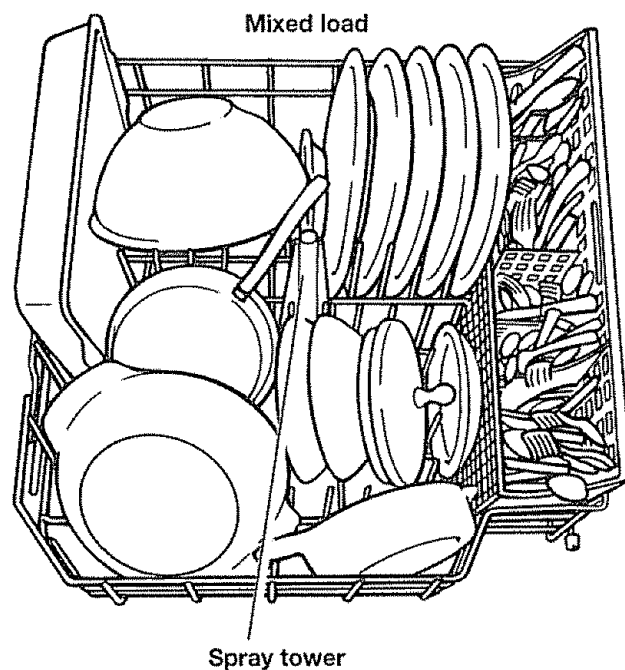

Fold-down divider

A fold-down divider at the back of the rack can be lowered to make room for deep bowls, roasters, etc.

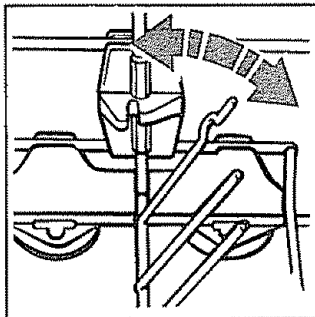

Loading the silverware basket

- Load the silverware basket while it is in the bottom rack or take the basket out for loading on a counter or table.

NOTE: You can remove the basket for easy unloading. Always unload or remove the basket before unloading the racks to avoid spilling water droplets on the silverware.

- Place small items (baby bottle caps, jar lids, etc.) in the section next to the hinged cover. Close the cover over the section to hold small items in place.

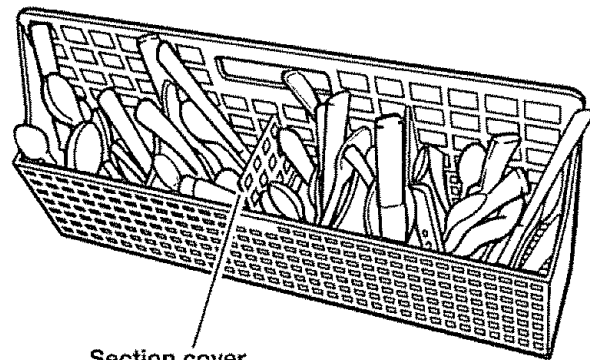

- Mix items in each section of the basket with some pointing up and some down to avoid nesting. Spray cannot reach nested items.

IMPORTANT: Always load sharp items (knives, skewers, forks, etc.) pointing down.

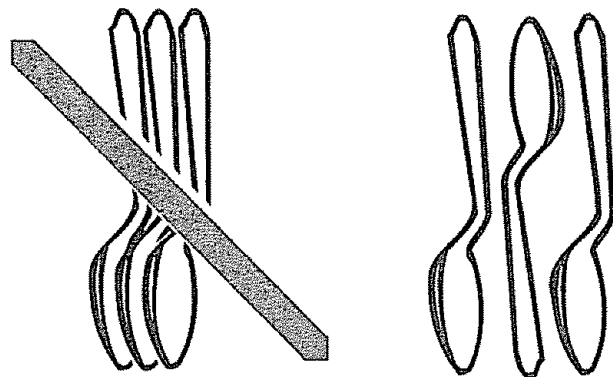

Quiet operating tips

To avoid thumping and clattering noises during operation:

- Make sure lightweight load items are secured in the racks.
- Make sure pot lids and handles, pizza pans, cookie sheets, etc., do not touch interior walls or interfere with the spray arm's rotation or cover the spray tower.

- Load dishes so they do not touch one another.

NOTE: Keep sink drain plugs inserted during dishwasher operation to prevent noise transfer through drains.

Tips for washing special items

If you have any doubts about washing a particular item, check with the manufacturer to see if it is dishwasher safe.		
MATERIAL	DISHWASHER SAFE?	EXCEPTIONS/SPECIAL INFORMATION
Aluminum	Yes	High water temperature and detergents may affect finish of anodized aluminum.
Bottles and Cans	No	Wash bottles and cans by hand. Labels attached with glue can loosen in your dishwasher. Loose labels and glue can clog spray arms or the pump and will reduce washing performance.
Cast Iron	No	Seasoning will be removed and iron will rust.
China/Stoneware	Yes	Always check manufacturer's recommendations before washing. Antique, hand-painted, or over-the-glaze patterns may fade. Gold leaf may discolor or fade.
Crystal	Yes	Always check manufacturer's recommendations before washing. Some types of leaded crystal may etch with repeated washings.
Gold	No	Gold-colored flatware will discolor.
Glass	Yes	Milk glass will yellow with repeated dishwasher washing.
Hollow-Handle Knives	No	Handles of some knives are attached to the blade with adhesives which may loosen if washed in the dishwasher.
Pewter	No	High water temperatures and detergent may discolor or pit finish.
Disposable Plastics	No	Cannot withstand high water temperatures and detergents.
Plastics	Yes	Always check manufacturer's recommendations before washing. Plastics vary in their capacity to withstand high water temperatures and detergents. Load plastics in top rack only.
Stainless Steel	Yes	Run a Quick Rinse cycle if not washing immediately. Prolonged contact with food containing salt, vinegar, milk products, or fruit juice could damage finish.
Sterling Silver or Silver Plate	Yes	Run a Quick Rinse cycle if not washing immediately. Prolonged contact with food containing salt, acid, or sulfide (eggs, mayonnaise, and seafood) could damage finish.
Tin	No	Can rust.
Wooden Ware	No	Wash by hand. Always check manufacturer's recommendations before washing. Untreated wood may warp, crack, or lose its finish.

Caring for Your Dishwasher

Your new dishwasher is designed to give you many years of dependable service. There are a few things you can do to maintain your dishwasher properly. This section tells you how to clean and care for your dishwasher. Refer to "Solutions to Common Problems" on pages 23-25 for special cleaning problems.

Cleaning your dishwasher

Cleaning the exterior

In most cases, regular use of a soft, damp cloth or sponge and a mild detergent is all that is necessary to keep the outside of your dishwasher nice looking and clean.

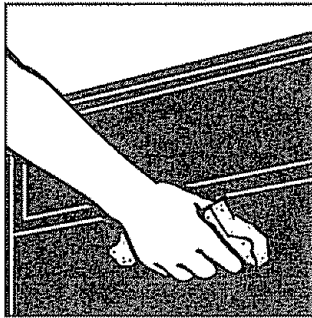

Cleaning the interior

Hard water minerals may cause a white film to build up on the inside surfaces, especially just beneath the door area. To clean interior:

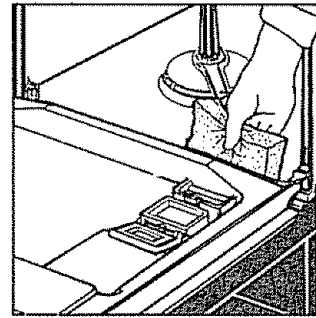

• Apply powdered dishwasher detergent to a damp sponge to make a paste.

OR

• Use liquid automatic dishwasher detergent

and clean with damp sponge.

Do not clean the dishwasher interior until it has cooled.

Wear rubber gloves. **Do not** use any type of cleanser other than dishwasher detergent because it may cause foaming or sudsing.

NOTE: Some tomato-based foods might permanently stain the inner tub and door liner. It is recommended that you prerinse concentrated amounts of soil from the dishes before loading.

Moving or winterizing your dishwasher

Moving or winterizing your dishwasher

Protect your dishwasher and home against water damage due to freezing water lines. If your dishwasher is left in a seasonal dwelling or could be exposed to near freezing temperatures, have a qualified person do the following:

1. Disconnect power supply to the dishwasher.
2. Turn off water supply to the dishwasher.
3. Remove the 4 screws on the lower access panel and remove the lower access panel.
4. Place a shallow pan under the water supply valve. Then, use a wrench to disconnect the water inlet from the water supply valve. Separate the water inlet from the water supply valve and drain water into the pan.
5. Remove the spring clamp from the water outlet and separate from the water supply valve; drain water into pan.

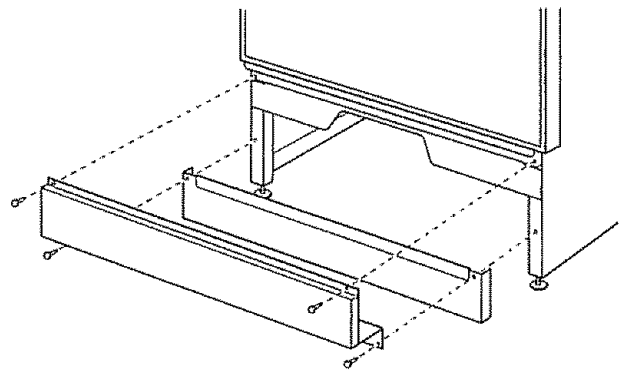

continued on next page

Moving or winterizing your dishwasher (cont.)

6. Reconnect both water inlet and water outlet to the water supply valve.
7. Empty the pan and reposition it under the water pump.
8. Remove the clamp and disconnect the drain hose from the water pump; drain water into pan
9. Reconnect drain hose to the water pump, being sure to position the clamp over the connection.
10. Replace the lower access panel.

Reconnecting your dishwasher

1. Remove the 4 screws on the lower access panel and remove lower access panel.
2. Turn on the water supply to dishwasher.
3. Turn on power supply to dishwasher.
4. Run dishwasher through a complete cycle and check for leaks.
5. Replace lower access panel.

NOTE: If your dishwasher is connected to a garbage disposal, do not run water into the sink after winterizing. This could cause water to refill the drain hose on your dishwasher.

Storing for the summer

Protect your dishwasher during the summer months by turning off the water supply and power supply to the dishwasher.

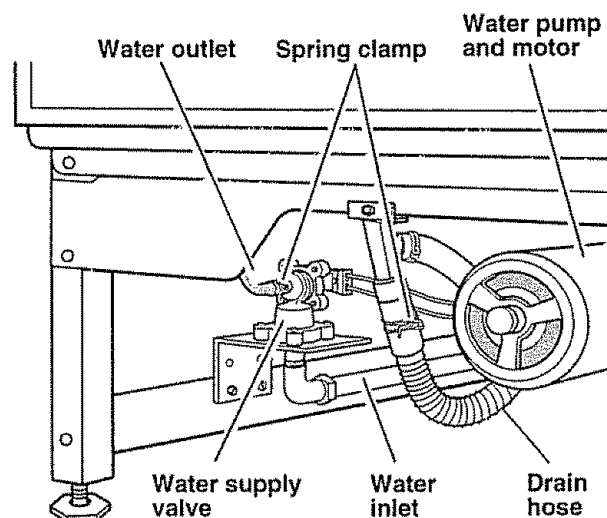

Energy saving tips

You can help save energy if you:

- Wash full loads. Running a half-filled dishwasher uses the same amount of electricity and hot water as a fully loaded machine.
- Use the Water Miser cycle if dishes are prerinse. The cycle uses less hot water and energy than the Normal Wash cycle.
- Use the No Heat Dry option when you don't need a rapid drying cycle. Allow longer drying times (overnight). Use a rinse agent to improve drying.
- Use the Water Heat option only when needed. When this option is off, the dishwasher will not pause to heat water to 135°F (57°C) during the main wash.

NOTE: Loads may not wash as well if the water temperature is too low.

- Load correctly for best washing results. Incorrect loading may cause poor washing and the need to rewash all or part of the load.
- Use the delay feature to run your dishwasher during off-peak hours. Local utilities recommend this to avoid heavy usage of energy at certain times of day.

Changing door color panel

NOTE: See your Installation Instructions for more complete information on changing door color panels or installing customized wood panels. The opposite side of the door panel is a different color. Additional colors are available through Sears Repair Services (see page 27).

Customized wood panels

Your dishwasher can be customized with wood panels. A heavy-duty door spring kit (Part No. 4318050) is needed if the upper panel weighs more than 4 pounds. The maximum weight for the upper panel and door is 8 pounds.

Changing door color panel (cont.)

Upper panel

1. Insert a finger under one end of the retainer. Pull the retainer towards you in a peeling action. Set retainer aside.

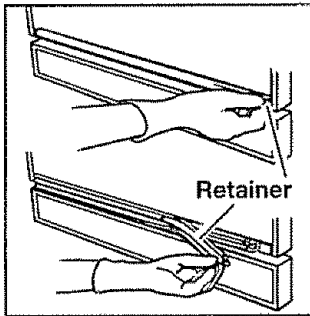

3. With desired color facing out, insert one side of color panel into door frame.

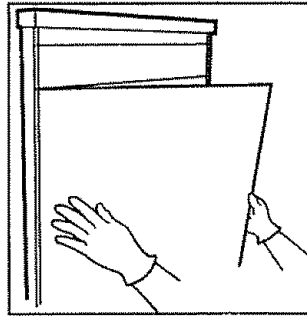

2. Lift color panels at outer edges. Use one hand to bow bottom of panel. Remove color panel(s). **Do not remove spacer.**

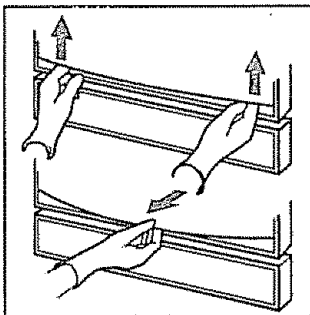

4. Bow color panel and insert other side into door frame.

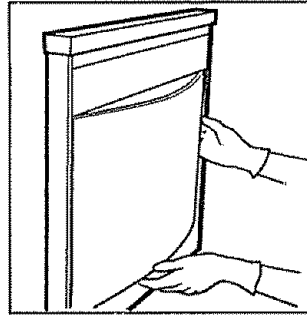

5. Push in on color panel(s) near the top and slide panel(s) and spacer up inside bottom of control panel. Let color panel(s) rest on channel at bottom of doors.

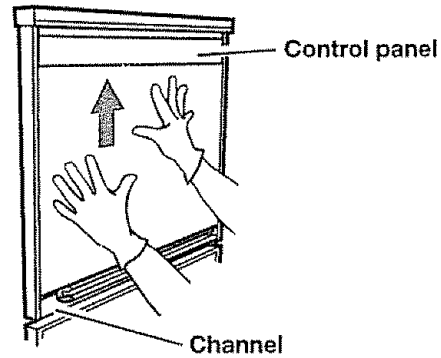

6. Snap one end of retainer into channel as shown. Push inward while sliding thumb along full length of retainer.

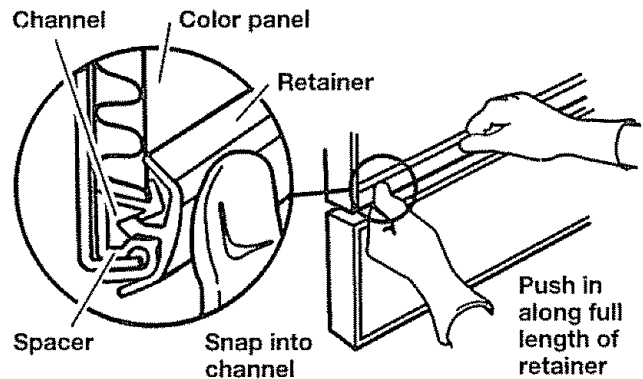

Changing door color panel (cont.)

Access panel

1. Push up with thumbs on each end of access panel top trim to unsnap trim. Remove trim and set aside.

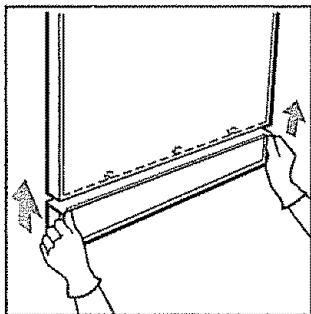

2. Carefully slide access panel upward and remove. **Do not remove spacer.**

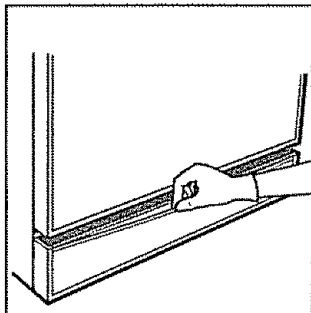

3. With desired color facing out, slide access panel into access panel frame.

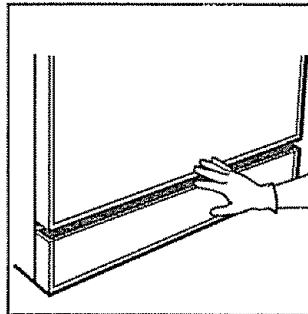

4. Make sure access panel has slid into groove along bottom of access panel frame.

5. Line up edges of top trim with sides of access panel frame. Tilt back of trim down and slide into place. Snap front of trim down to cover top edge of access panel.

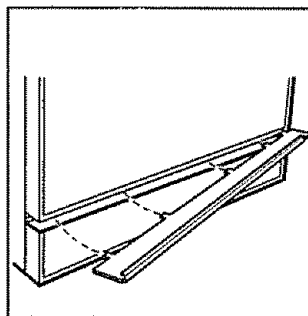

Solutions to Common Problems

The following chart is a convenient checklist for handling minor performance problems. Go over this list before calling for service. If you are unable to solve your dishwasher's problem, please see "Troubleshooting." If you still need help, see "Sears Repair Services" toll-free numbers on page 27.

PROBLEM	CAUSE	SOLUTION
Food soil left on dishes	Improper loading	Follow loading instructions on pages 13-17.
	Water temperature is too low	Use the Water Heat option. If needed, turn home water heater up to ensure water entering dishwasher is 120°F (49°C) minimum. See "Water temperature tips" on page 12.
	Use of incorrect, too little, or ineffective detergent	Use recommended dishwasher detergents only. Follow recommendations on page 11 for amounts; never use less than 1 tablespoon per load. Detergent must be fresh to be effective. Always store detergent in a cool, dry area.
	Detergent cakes in dispenser	Use fresh detergent only. Do not allow detergent to sit for several hours in a wet dispenser. Check dispenser for caked detergent. Clean dispenser when caked detergent is present.
	Pump or spray arm clogged by labels from bottles and cans	Remove labels before washing bottles and cans or wash by hand. See page 18.
	Low water pressure caused by insufficient fill	Home water pressure should be 20 to 120 pounds per square inch (psi) for proper dishwasher fill. A booster pump on the water supply may be necessary if pressure is too low.
Spotting and filming	Slowdown of wash arm due to high suds	Never use soap or laundry detergents. Use recommended dishwasher detergents only.
	Hard water or high mineral content in water	Conditioning the final rinse water with a liquid rinse agent helps eliminate spotting and filming. Keep the dispenser full with a rinse agent at all times.
	Water temperature is too low	Use the Water Heat option, if available. If needed, turn home water heater up to ensure water entering dishwasher is 120°F (49°C) minimum. See "Water temperature tips" on page 12.
	Use of incorrect detergents	Use recommended dishwasher detergents only.
	Incorrect amount of detergent	Follow recommendations on page 11 for amount. Heavy soil and/or hard water generally require extra detergent.
Use of ineffective detergents	Detergent should be fresh. Store in a cool, dry place, preferably in an airtight container. Discard lumpy detergent.	

continued on next page

PROBLEM	CAUSE	SOLUTION
Spotting and filming (cont.)	Insufficient fill caused by low water pressure	<p>Home water pressure should be 20 to 120 psi for proper dishwasher fill. A booster pump on the water supply may be necessary if pressure is too low.</p> <p>NOTE: To remove spots and film from dishes, try a vinegar rinse.</p> <ol style="list-style-type: none"> 1. Wash and rinse as usual using the Air Dry option. 2. Remove all metal items. 3. Put 2 cups (500 mL) white vinegar in a container on the bottom rack. 4. Run dishwasher through complete washing cycle. Vinegar will mix with wash water.
Cycle takes extremely long time	Water temperature is too low	If needed, turn home water heater up to ensure water entering dishwasher is 120°F (49°C) minimum. See "Water temperature tips" on page 12.
Dishes do not dry completely	<p>Dishes do not drain properly</p> <p>Plastics</p> <p>Rinse agent dispenser is empty</p>	<p>Dishes must have proper water drainage. Do not overload. Follow instructions for loading dishwasher on pages 13-17. Use a liquid rinse agent to speed drying.</p> <p>Some plastics, due to material, may need to be towel dried.</p> <p>Fill rinse agent dispenser. See page 12.</p>
Silica film or etching (silica film is a white iridescent deposit; etching is a cloudy film)	A water chemical reaction with certain types of glassware. Usually caused by some combination of soft or softened water, alkaline washing solutions, insufficient rinsing, over-loading the dishwasher, and heat of drying.	It may not be possible to prevent problem, except by hand washing. To slow this process, use a minimum amount of detergent but not less than 1 tablespoon per load. Use a liquid rinse agent and underload the dishwasher to allow thorough rinsing. Silica film and etching are permanent and cannot be removed. Use the Air Dry option.
Black or gray marks on dishes	Aluminum items	Aluminum items should be loaded so that they will not rub against dishes during washing. Throwaway aluminum items should not be washed in the dishwasher because they may break down and cause marking. Aluminum markings can be removed by using a mild abrasive cleanser.
Brown stains on dishes and dishwasher interior	High iron content in water supply	Remove by washing dishes (after food soil has been removed) with 1 teaspoon to 1 tablespoon of citric acid crystals added to covered section of detergent dispenser. Do not use detergent. Follow with a Normal cycle with detergent. If treatment is needed more often than every other month, the installation of an iron removal unit is recommended.

PROBLEM	CAUSE	SOLUTION
Orange stains on dishwasher interior	Large amounts of tomato-based foods on dishes placed in the dishwasher	Stains may gradually fade over time. Regular use of heated drying may cause stains to fade slower. Stains will not affect dishwasher performance. Regular use of Quick Rinse cycle or Air Dry option will reduce the likelihood of staining.
White spots on cookware with non-stick finish	Seasoning removed by dishwasher detergents	Reseason cookware after dishwasher washing.
Odor in the dishwasher	Dishes only washed every 2-3 days	Run a Quick Rinse cycle at least once or twice a day until a full load is accumulated.
Chipping of dishes	Improper loading	Load dishes and glasses so that they are stable and do not strike together from washing action. Moving racks in and out slowly will also minimize chipping. NOTE: Some types of china and glassware are too delicate for automatic dishwashing and should be hand washed; for example: antiques, feather-edged crystal, and similar types.

Troubleshooting

Please check the chart below for problems you can fix. It could save you the cost of a service call. If you still need help, see "Sears Repair Services" toll-free numbers on page 27.

PROBLEM	CHECK THE FOLLOWING
Dishwasher does not run or stops during a cycle	<p>Is the door tightly closed and securely latched?</p> <p>Has the cycle been set correctly?</p> <p>Has a household fuse or circuit breaker blown or tripped?</p> <p>Is the delay feature on?</p> <p>If the motor has stopped because of an overload, it will automatically reset itself within a few minutes. If the motor does not start, call for service.</p> <p>Is the water supply turned on?</p>
Dishwasher seems to run too long	<p>The dishwasher will run longer while heating water. This is normal. The time showing on the electronic display will pause while water is heating. See pages 9 and 10.</p> <p>If the water temperature is below 135°F (57°C):</p> <ul style="list-style-type: none"> ◦ a delay will occur in the main wash if the Water Heat option is selected ◦ three delays will occur if the Pots Pans cycle is selected. ◦ the final rinse will automatically delay until the water temperature reaches 135°F (57°C).
Dishwasher will not fill	<p>Is overfill protector stuck in "up" position? Overfill protector should move up and down freely. Press down to release.</p>
Water remains in dishwasher	<p>Wait for the cycle to finish. A small amount of water remaining is normal.</p> <p>Check the drain air gap accessory (if installed) to see if it is clogged.</p>
Detergent remains in covered section of dispenser	<p>Has the cycle completed?</p> <p>Is the detergent fresh and dry without lumps?</p> <p>Is the bottom rack in backwards? The rack bumpers should face the door.</p>
Dishes are not as dry as you expected	<p>Is the rinse agent dispenser empty? Using a rinse agent greatly improves drying. See page 12.</p> <p>Do not use No Heat Dry option on the next load.</p>
Grinding, grating, crunching, or buzzing sounds	<p>Has a hard object entered the ULTRA WASH™ module? The sound should stop when the object is ground up.</p>
White residue appears on front of access panel	<p>Is too much detergent being used? See page 11 for recommended amounts of detergent.</p> <p>Some liquid detergents develop excess foam and buildup on access panel. Try a different brand to reduce foaming and eliminate buildup.</p>

Sears Repair Services

For the repair or replacement
parts you need

Call 7 am - 7 pm, 7 days a week

1-800-366-PART

(1-800-366-7278)

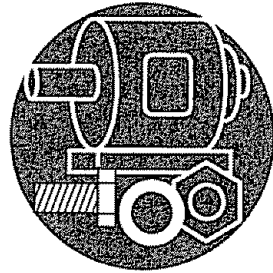

For in-home major brand repair service

Call 24 hours a day, 7 days a week

1-800-4-REPAIR

(1-800-473-7247)



For the location of a Sears Repair
Service Center in your area

Call 24 hours a day, 7 days a week

1-800-488-1222

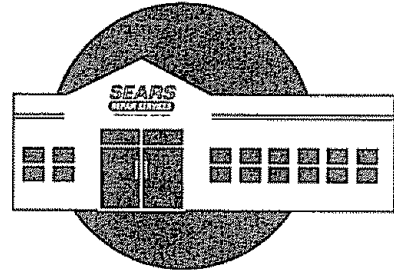

For information on purchasing a Sears
Maintenance Agreement or to inquire
about an existing Agreement

Call 9 am - 5 pm, Monday - Saturday

1-800-827-6655

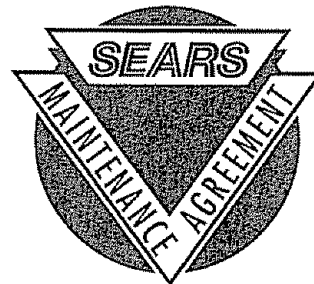

SEARS
REPAIR SERVICES

America's Repair Specialists

Sears Dishwasher Warranty

FULL ONE-YEAR WARRANTY ON DISHWASHERS

For one year from the first day of use in your home, Sears will repair, free of charge, defects in materials or workmanship.

LIMITED WARRANTY ON THE ULTRA WASH™ WASH SYSTEM

After the first year and through two years from the first day of use in your home, Sears will furnish, free of charge, replacement parts for any part of the ULTRA WASH wash system (motor, pump, spray arms, nozzle cap, spray tower, motor seals, and pump gasket) which is defective in materials or workmanship. YOU PAY THE LABOR.

FULL TWO-YEAR WARRANTY ON ELECTRONIC CONTROL AND POWER SUPPLY BOARD

For two years from the first day of use in your home, Sears will repair or replace, free of charge, the electronic module and power supply board, if defective in materials or workmanship.

FULL WARRANTY FOR THE LIFE OF THE DISHWASHER ON ULTRA LIFE™ TUB MODELS AGAINST LEAKS IN THE TUB AND INNER DOOR PANEL

For the life of the dishwasher if a leak should occur as a result of failure of the polypropylene inner door panel or tub due to cracking, chipping, or peeling, Sears will replace, free of charge, the tub or inner door panel.

If the dishwasher is subjected to other than private family use, the above warranty coverage is effective for only ninety days.

WARRANTY SERVICE IS AVAILABLE BY CONTACTING THE NEAREST SEARS SERVICE CENTER/DEPARTMENT IN THE UNITED STATES. This warranty applies only while this product is in use in the United States.

This warranty gives you specific legal rights, and you may also have other rights which vary from state to state.

Sears, Roebuck and Co., Dept. 817WA, Hoffman Estates, IL 60179

We Service What We Sell

"We Service What We Sell" is our assurance you can depend on Sears for service. Your dishwasher has added value when you consider that Sears has service units nationwide, staffed with professional technicians specifically trained on Sears appliances and having the parts, tools, and equipment to ensure that we meet our pledge to you ... "We Service What We Sell."

Sears Maintenance Agreement

Maintain the value of your KENMORE Dishwasher with a Sears Maintenance Agreement. Sears dishwashers are designed, manufactured, and tested for years of dependable operation. Yet, any modern appliance may require service from time to time.

The Sears Maintenance Agreement:

- Is your way to buy tomorrow's service at today's prices.
- Eliminates repair bills resulting from normal use.
- Allows for as many service calls as required.
- Provides for service by professional Sears Trained Technicians.
- Even if you don't need repairs, the Maintenance Agreement offers an annual preventative maintenance check-up at your request!

This Maintenance Agreement does not cover original installation, reinstallation, or damage resulting from external causes such as acts of abuse, theft, fire, flood, wind, lightning, freezing, power failure, power reduction, etc.