

INSTALLATION/OPERATION & TECHNICAL MANUAL

FOR JACKSON MODELS:

AJ-44CE	AJ-66CE	AJ-80CE
AJ-44CEL	AJ-66CEL	AJ-80CEL
AJ-44CGP	AJ-66CGP	AJ-80CS
AJ-44CS	AJ-66CS	AJ-80CSL
AJ-44CSL	AJ-66CSL	



MANUFACTURERS WARRANTY

ONE YEAR LIMITED PARTS & LABOR WARRANTY

ALL NEW JACKSON DISHWASHERS ARE WARRANTED TO THE ORIGINAL PURCHASER TO BE FREE FROM DEFECTS IN MATERIAL OR WORKMANSHIP, UNDER NORMAL USE AND OPERATION FOR A PERIOD OF (1) ONE YEAR FROM THE DATE OF PURCHASE, BUT IN NO EVENT TO EXCEED (18) EIGHTEEN MONTHS FROM THE DATE OF SHIPMENT FROM THE FACTORY.

Jackson MSC agrees under this warranty to repair or replace, at its discretion, any original part which fails under normal use due to faulty material or workmanship during the warranty period, providing the equipment has been unaltered, and has been properly installed, maintained and operated in accordance with the applicable factory instruction manual furnished with the machine and the failure is reported to the authorized service agency within the warranty period. This includes the use of factory specified genuine replacement parts, purchased directly from a Jackson authorized parts distributor or service agency. Use of generic replacement parts may create a hazard and void warranty certification.

The labor to repair or replace such failed part will be paid by Jackson MSC, within the continental United States, Hawaii and Canada, during the warranty period provided a Jackson MSC authorized service agency, or those having prior authorization from the factory, performs the service. Any repair work by persons other than a Jackson MSC authorized service agency is the sole responsibility of the customer. Labor coverage is limited to regular hourly rates, overtime premiums and emergency service charges will not be paid by Jackson MSC.

Accessory components not installed by the factory carry a (1) one year parts warranty only. Accessory components such as table limit switches, pressure regulators, pre rinse units, etc. that are shipped with the unit and installed at the site are included. Labor to repair or replace these components is not covered by Jackson MSC.

This warranty is void if failure is a direct result from shipping, handling, fire, water, accident, misuse, acts of god, attempted repair by unauthorized persons, improper installation, if serial number has been removed or altered, or if unit is used for purpose other than it was originally intended.

TRAVEL LIMITATIONS

Jackson MSC limits warranty travel time to (2) two hours and mileage to (100) one hundred miles. Jackson MSC will not pay for travel time and mileage that exceeds this, or any fees such as those for air or boat travel without prior authorization.

WARRANTY REGISTRATION CARD

The warranty registration card supplied with the machine must be returned to Jackson MSC within 30 days to validate the warranty.

REPLACEMENT PARTS WARRANTY

Jackson replacement parts are warranted for a period of 90 days from the date of installation or 180 days from the date of shipment from the factory, whichever ever occurs first.

PRODUCT CHANGES AND UPDATES

Jackson MSC reserves the right to make changes in design and specification of any equipment as engineering or necessity requires.

THIS IS THE ENTIRE AND ONLY WARRANTY OF JACKSON MSC. JACKSON'S LIABILITY ON ANY CLAIM OF ANY KIND, INCLUDING NEGLIGENCE, WITH RESPECT TO THE GOODS OR SERVICES COVERED HEREUNDER, SHALL IN NO CASE EXCEED THE PRICE OF THE GOODS OR SERVICES OR PART THEREOF WHICH GIVES RISE TO THE CLAIM.

THERE ARE NO WARRANTIES, EXPRESSED OR IMPLIED, INCLUDING FOR FITNESS OR MERCHANTABILITY, THAT ARE NOT SET FORTH HEREIN, OR THAT EXTEND BEYOND THE DURATION HEREOF. UNDER NO CIRCUMSTANCES WILL JACKSON MSC BE LIABLE FOR ANY LOSS OR DAMAGE, DIRECT OR CONSEQUENTIAL, OR FOR THE DAMAGES IN THE NATURE OF PENALTIES, ARISING OUT OF THE USE OR INABILITY TO USE ANY OF ITS PRODUCTS.

ITEMS NOT COVERED

This warranty does not cover cleaning or deliming of the unit or any component such as, but not limited to, wash arms, rinse arms or strainers at anytime. Nor does it cover adjustments such as, but not limited to timer cams, thermostats or doors, beyond 30 days from the date of installation. In addition, the warranty will only cover the replacement of wear items such as curtains, drain balls, door guides or gaskets during the first 30 days after installation. Also, not covered are conditions caused by the use of incorrect (non-Commercial) grade detergents, incorrect water temperature or pressure, or hard water conditions.



**CALL 1-888-800-5672 TO REGISTER THIS PRODUCT!
FAILURE TO DO SO WILL VOID THE WARRANTY!**

**LLAME AL 1-888-800-5672 PARA REGISTRAR ESTE PRODUCTO!
AL NO HACERLO LA GARANTIA SERA ANULADA!**

**S.V.P. APPELER 1-888-800-5672 POUR ENREGISTRER CE PRODUIT,
LA GARANTIE SERA ANNULEE POUR TOUT PRODUIT NON- ENREGISTREE**



AJ-44CSL

AJ = AJ series of rack conveyors

44 = 44" wide machine

66 = 66" wide machine

80 = 80" wide machine

CE = Electrically heated, hot water sanitizing machine

CEL = Electrically heated, chemical sanitizing machine

CS = Steam heated, hot water sanitizing machine

CSL = Steam heated, chemical sanitizing machine

CGP = Gas heated, hot water sanitizing machine

Model: _____

Serial No.: _____

Installation Date: _____

Service Rep. Name: _____

Phone No.: _____

Jackson MSC LLC. provides technical support for all of the dishmachines detailed in this manual. We strongly recommend that you refer to this manual before making a call to our technical support staff. Please have this manual with you when you call so that our staff can refer you, if necessary, to the proper page. Technical support is available from 8:00 a.m. to 5:00 p.m. (EST), Monday through Friday. Technical support is not available on holidays. Contact technical support toll free at 1-888-800-5672. Please remember that technical support is available for service personnel only.

TABLE OF CONTENTS

<u>SECTION</u>	<u>DESCRIPTION</u>	<u>PAGE</u>
I.	SPECIFICATION INFORMATION	
	Operating Characteristics	2
	Electrical Requirements	3
	D226 Steam Booster Parameters	4
	AJ-44 Electric - Left to Right	5
	AJ-44 Electric - Right to Left	6
	AJ-44 Gas - Left to Right	7
	AJ-44 Gas - Right to Left	8
	AJ-44 Steam - Left to Right	9
	AJ-44 Steam - Right to Left	10
	AJ-66 Electric - Left to Right	11
	AJ-66 Electric - Right to Left	12
	AJ-66 Gas - Left to Right	13
	AJ-66 Gas - Right to Left	14
	AJ-66 Steam - Left to Right	15
	AJ-66 Steam - Right to Left	16
	AJ-80 Electric - Left to Right	17
	AJ-80 Electric - Right to Left	18
	AJ-80 Gas - Left to Right	19
	AJ-80 Gas - Right to Left	20
	AJ-80 Steam - Left to Right	21
	AJ-80 Steam - Right to Left	22
	Side Loader (Left to Right) Dimensions	23
	Side Loader (Right to Left) Dimensions	24
	Side Loader (Installed) Dimensions	25
	D226 Steam Booster Dimensions	26
	D226 Steam Booster Plumbing Line Drawings	27
	Typical Electric and Gas Booster Dimensions	28
II.	INSTALLATION & OPERATION INSTRUCTIONS	
	Installation Instructions	30
	Delimiting Operations	33
	Changing the AJ-44CE/CS Direction of Travel	34
	Curtain Installation Diagrams	40
	Side Loader Installation & Operation Instructions	41
	D226 Steam Booster Installation & Operation Instructions	42
	Gas Conveyor Hose Installation	44
	Dishmachine Operating Instructions	46
	Changing Dual Sanitization Mode	48
	Detergent Control	50
	Striker Plate Limit Switch Installation Instructions	51
III.	PREVENTATIVE MAINTENANCE	
	General Maintenance	53
	D226 Maintenance	54
	Lubrication Chart for Drive Gear	55
	Drive Motor Gear Reducer Preventative Maintenance	56
IV.	TROUBLESHOOTING SECTION	
	Common Problems	58
	D226 Common Problems	60

TABLE OF CONTENTS

PARTS

V.	PARTS SECTION	
	AJ-44 Control Box Assembly	62
	AJ-66/AJ-80 Control Box Assembly	64
	Motor Overload Chart	66
	Heater Assembly	67
	Thermostats/Dress Panels	69
	Prewash Plumbing Assembly	70
	Wash Section Plumbing	71
	External Electric Booster Option Incoming Plumbing	72
	External Electric Booster Option Outlet Plumbing	73
	Water Hammer Arrestor Option WPRK Plumbing Option	74
	3/4" Solenoid Valve & 3/4" NPT Vacuum Breaker Repair Parts Kits	75
	Steam Unit Wash Tank Coil Assembly	76
	Steam Plumbing (Left to Right)	77
	Steam Plumbing (Right to Left)	78
	Gas Coil Assembly (CGP Models)	79
	Rinse Booster Tank Assembly (CGP Models)	80
	Recirculating Pump Assembly (CGP Models)	81
	Hose Connections (CGP Models)	82
	Wash/Fill Plumbing Assembly (CGP Models)	83
	Rinse Header Plumbing Assembly (CGP Models)	84
	AJ-44 Series Drain Plumbing Assemblies	85
	AJ-66 Drain Plumbing Assemblies	86
	AJ-80 Drain Plumbing Assemblies	87
	AJ-66 Drain Plumbing Assembly (Left to Right) (CGP Models)	88
	AJ-66 Drain Plumbing Assembly (Right to Left) (CGP Models)	89
	Drain Quench Assembly	90
	Motor Assemblies	91
	Prewash & Wash Pump Weldments	92
	Lower Wash Arm Assembly	93
	Prewash Arm/Upper Wash Arm Assembly	94
	Curtains/Tub Magnets	95
	Final Rinse Assembly	96
	Drive Assembly	97
	Door Assemblies	99
	Pawl Bar Miscellaneous Components	100
	AJ-44 & AJ-66 Pawl Bar Assemblies	101
	AJ-80 Pawl Bar Assemblies	102
	AJ-44 Rack Rail Assembly	103
	AJ-66 Rack Rail Assemblies	104
	AJ-80 Rack Rail Assemblies	105
	Miscellaneous Parts & Weldments	106
	Manifolds/Strainer Support Weldments	107
	Strainers	108
	Float Switch Components/Scrap Baskets	109
	Vent Cowl Assembly/Vent Scoop Option	110
	Exhaust Fan Control/Table Limit Switch	111
	SIDE LOADER SECTION	
	Side Loader Track Assembly/Leg Replacements/Strainer	112
	Side Loader Pawl Bar Assemblies/Pawl Bar Bracket/Magnet	113
	Side Loader Vent Cowl Option	114
	D226 STEAM BOOSTER SECTION	
	Control Box Assembly	115
	Plumbing Assembly	116
	Go*Box Components	118
	BC Ferries Options	119

TABLE OF CONTENTS
ELECTRICAL SCHEMATICS

VI.	ELECTRICAL SCHEMATICS	
	AJ-44CE/CEL	
	200-230 Volt, 50/60 Hz, 1 Phase Primary Side	121
	200-230 Volt, 50/60 Hz, 1 Phase Secondary Side	122
	200-230 Volt, 50/60 Hz, 3 Phase Primary Side	123
	200-230 Volt, 50/60 Hz, 3 Phase Secondary Side	124
	380-460-600 Volt, 60 Hz, 3 Phase Primary Side	125
	380-460-600 Volt, 60 Hz, 3 Phase Secondary Side	126
	380-415 Volt, 50 Hz, 3 Phase Primary Side	127
	380-415 Volt, 50 Hz, 3 Phase Secondary Side	128
	440 Volt, 50 Hz, 3 Phase Primary Side	129
	440 Volt, 50 Hz, 3 Phase Secondary Side	130
	440 Volt, 50 Hz, 3 Phase, 5 Wire Primary Side	131
	440 Volt, 50 Hz, 3 Phase, 5 Wire Secondary Side	132
	AJ-44CS/CSL	
	200-230 Volt, 50/60 Hz, 1 Phase Primary Side	133
	200-230 Volt, 50/60 Hz, 1 Phase Secondary Side	134
	200-230 Volt, 50/60 Hz, 3 Phase Primary Side	135
	200-230 Volt, 50/60 Hz, 3 Phase Secondary Side	136
	380-415-440-460-600 Volt, 60 Hz, 3 Phase Primary Side	137
	380-415-440-460-600 Volt, 60 Hz, 3 Phase Secondary Side	138
	AJ-66CE/CEL & AJ-80CE/CEL	
	200-230 Volt, 50/60 Hz, 1 Phase Primary Side	139
	200-230 Volt, 50/60 Hz, 1 Phase Secondary Side	140
	200-230 Volt, 50/60 Hz, 3 Phase Primary Side	141
	200-230 Volt, 50/60 Hz, 3 Phase Secondary Side	142
	380-460-600 Volt, 60 Hz, 3 Phase Primary Side	143
	380-460-600 Volt, 60 Hz, 3 Phase Secondary Side	144
	380-415-440 Volt, 50 Hz, 3 Phase Primary Side	145
	380-415-440 Volt, 50 Hz, 3 Phase Secondary Side	146
	AJ-66CS/CSL & AJ-80CS/CSL	
	200-230 Volt, 50/60 Hz, 1 Phase Primary Side	147
	200-230 Volt, 50/60 Hz, 1 Phase Secondary Side	148
	200-230 Volt, 50/60 Hz, 3 Phase Primary Side	149
	200-230 Volt, 50/60 Hz, 3 Phase Secondary Side	150
	380-415-440-460-600 Volt, 60 Hz, 3 Phase Primary Side	151
	380-415-440-460-600 Volt, 60 Hz, 3 Phase Secondary Side	152
	AJ-44CGP	
	200-230 Volt, 50/60 Hz, 1 Phase Primary Side	153
	200-230 Volt, 50/60 Hz, 1 Phase Secondary Side	154
	200-230 Volt, 50/ Hz, 3 Phase Primary Side	155
	200-230 Volt, 50/ Hz, 3 Phase Secondary Side	156
	460 Volt/60 Hz/3 Phase Primary Side	157
	460 Volt/60 Hz/3 Phase Primary Side	158
	AJ-66CGP, AJ-80CGP	
	200-230 Volt, 50/60 Hz, 1 Phase Primary Side	159
	200-230 Volt, 50/60 Hz, 1 Phase Secondary Side	160
	200-230 Volt, 50/60 Hz, 3 Phase Primary Side	161
	200-230 Volt, 50/60 Hz, 3 Phase Secondary Side	162
	460 Volt, 50/60 Hz, 3 Phase Primary Side	163
	460 Volt, 50/60 Hz, 3 Phase Secondary Side	164
	Conveyor Side Loader/D226 Steam Booster	165
	Exhaust Fan Hook-Up Schematics	166
VIII.	MAINTENANCE & REPAIR CENTERS	177

SECTION 1: SPECIFICATION INFORMATION

SECTION 1: SPECIFICATION INFORMATION

OPERATING CHARACTERISTICS

RACKS PER HOUR:

AJ-44-66-80CE/CS/CGP	248
AJ-44-66-80CEL/CSL	234

DISHES OR GLASSES PER HOUR:

AJ-44-66-80CE/CS/CGP	6200
AJ-44-66-80CEL/CSL	5850

PREWASH TANK CAPACITY (GALLONS):

AJ-66CE/CEL/CS/CSL/CGP	16
AJ-80CE/CEL/CS/CSL/CGP	16

WASH TANK CAPACITY (GALLONS):

AJ-44-66-80CE/CS/CGP	15.4
----------------------	------

PREWASH PUMP CAPACITY (GPM):

AJ-66CE/CEL/CS/CSL/CGP	120
AJ-80CE/CEL/CS/CSL/CGP	270

WASH PUMP CAPACITY

GALLONS PER MINUTE (ALL MODELS):	270
----------------------------------	-----

VENTING REQUIREMENTS (CFM)(100% CAP.):

INPUT END	200
OUTPUT END	400
TOTAL	600

CONVEYOR SPEED (FPM):

AJ-44-66-80CE/CS/CGP MACHINES	6.9
AJ-44-66-80CEL/CSL MACHINES	6.5

GALLONS PER RACK:

AJ-44-66-80CE/CS/CGP MACHINES	.94
AJ-44-66-80CEL/CSL MACHINES	1.00

WATER TEMPERATURES:**AJ-44-66-80CE/CS/CGP MODELS:**

PREWASH (RECOMMENDED)	110-140°F
WASH (MINIMUM)	160°F
RINSE (MINIMUM)	180°F

AJ-44-66-80CEL/CSL MODELS:

PREWASH (RECOMMENDED)	110-140°F
WASH (MINIMUM)	140°F
RINSE (MINIMUM)	140°F

FLOW PRESSURE (PSI)

20 ± 5

FLOWRATE (GPM):

AJ-44-66-80CE/CS/CGP	3.9
AJ-44-66-80CEL/CSL	3.9

MINIMUM CHLORINE (PPM)

AJ-44-66-80CEL/CSL MODELS ONLY:	50
---------------------------------	----

STEAM COIL TANK HEAT (CS/CSL MODELS ONLY):

STEAM INLET PRESSURE (PSIG)	10-20
STEAM CONNECTION NPT	3/4"
CONSUMPTION @ 15 PSIG (lbs/hr):	
AJ-44-66-80CS/CSL	60

MOTOR ELECTRICAL CHARACTERISTICS:

DRIVE MOTOR HP	1/4
WASH MOTOR HP	2
POWER RINSE MOTOR HP	2
PREWASH MOTOR HP:	
AJ-66 MODELS	1
AJ-80 MODELS	2

NOTE: Typical Electrical Circuit is based upon (1) 125% of the full amperage load of the machine and (2) typical fixed-trip circuit breaker sizes as listed in the NEC 2002 Edition. Local codes may require more stringent protection than what is displayed here. Always verify with your electrical service contractor that your circuit protection is adequate and meets all applicable national and local codes. These numbers are provided in this manual simply for reference and may change without notice at any given time.

SECTION 1: SPECIFICATION INFORMATION
ELECTRICAL REQUIREMENTS

AJ-44CE/CEL MODELS

<u>VOLTS</u>	<u>PH</u>	<u>HZ</u>	<u>TOTAL AMPS</u>	<u>TYPICAL ELECTRICAL CIRCUIT</u>
208	3	50	55 A	70 AMP
220	3	50	49 A	70 AMP
230	3	50	51 A	70 AMP
380	3	50	29 A	40 AMP
415	3	50	28 A	35 AMP
440	3	50	28 A	35 AMP
208	1	60	83 A	110 AMP
230	1	60	76 A	100 AMP
200	3	60	47 A	60 AMP
208	3	60	49 A	70 AMP
230	3	60	45 A	60 AMP
380	3	60	29 A	40 AMP
460	3	60	23 A	30 AMP
600	3	60	19 A	25 AMP

AJ-66CE/CEL MODELS

<u>VOLTS</u>	<u>PH</u>	<u>HZ</u>	<u>TOTAL AMPS</u>	<u>TYPICAL ELECTRICAL CIRCUIT</u>
208	3	50	58 A	80 AMP
220	3	50	53 A	70 AMP
230	3	50	54 A	70 AMP
380	3	50	31 A	40 AMP
415	3	50	34 A	45 AMP
440	3	50	33 A	45 AMP
208	1	60	89 A	125 AMP
230	1	60	82 A	110 AMP
200	3	60	51 A	70 AMP
208	3	60	52 A	70 AMP
230	3	60	48 A	60 AMP
380	3	60	31 A	40 AMP
460	3	60	24 A	30 AMP
600	3	60	22 A	30 AMP

AJ-44CGP MODELS

<u>VOLTS</u>	<u>PH</u>	<u>HZ</u>	<u>TOTAL AMPS</u>	<u>TYPICAL ELECTRICAL CIRCUIT</u>
208	1	60	12 A	15 AMP
230	1	60	11 A	15 AMP
208	3	60	8 A	15 AMP
230	3	60	7 A	15 AMP
460	3	60	5 A	15 AMP

AJ-66CGP MODELS

<u>VOLTS</u>	<u>PH</u>	<u>HZ</u>	<u>TOTAL AMPS</u>	<u>TYPICAL ELECTRICAL CIRCUIT</u>
208	1	60	17 A	15 AMP
230	1	60	17 A	15 AMP
208	3	60	11A	15 AMP
230	3	60	11A	15 AMP
460	3	60	6 A	15 AMP

AJ-44CS/CSL MODELS

<u>VOLTS</u>	<u>PH</u>	<u>HZ</u>	<u>TOTAL AMPS</u>	<u>TYPICAL ELECTRICAL CIRCUIT</u>
208	3	50	13 A	20 AMP
220	3	50	13 A	20 AMP
230	3	50	13 A	20 AMP
380	3	50	6 A	15 AMP
415	3	50	7 A	15 AMP
440	3	50	6 A	15 AMP
208	1	60	11 A	15 AMP
230	1	60	11 A	15 AMP
200	3	60	7 A	15 AMP
208	3	60	7 A	15 AMP
230	3	60	7 A	15 AMP
380	3	60	6 A	15 AMP
460	3	60	4 A	15 AMP
600	3	60	4 A	15 AMP

AJ-66CS/CSL MODELS

<u>VOLTS</u>	<u>PH</u>	<u>HZ</u>	<u>TOTAL AMPS</u>	<u>TYPICAL ELECTRICAL CIRCUIT</u>
208	3	50	17 A	25 AMP
220	3	50	17 A	25 AMP
230	3	50	17 A	25 AMP
380	3	50	6A	15 AMP
415	3	50	7 A	15 AMP
440	3	50	6 A	15 AMP
208	1	60	18 A	25 AMP
230	1	60	18 A	25 AMP
200	3	60	12 A	15 AMP
208	3	60	12 A	15 AMP
230	3	60	12 A	15 AMP
380	3	60	12 A	15 AMP
460	3	60	7 A	15 AMP
600	3	60	7 A	15 AMP

SECTION 1: SPECIFICATION INFORMATION

ELECTRICAL REQUIREMENTS (CONTINUED)/D226 STEAM BOOSTER PARAMETERS

AJ-80CE/CEL MODELS

<u>VOLTS</u>	<u>PH</u>	<u>HZ</u>	<u>TOTAL AMPS</u>	<u>TYPICAL ELECTRICAL CIRCUIT</u>
208	3	50	68 A	90 AMP
220	3	50	62 A	80 AMP
230	3	50	63 A	80 AMP
380	3	50	34 A	45 AMP
415	3	50	25 A	35 AMP
440	3	50	22 A	30 AMP
208	1	60	91 A	125 AMP
230	1	60	84 A	110 AMP
200	3	60	53 A	70 AMP
208	3	60	54 A	70 AMP
230	3	60	50 A	70 AMP
380	3	60	34 A	45 AMP
460	3	60	25 A	35 AMP
600	3	60	22 A	30 AMP

AJ-80CS/CSL MODELS

<u>VOLTS</u>	<u>PH</u>	<u>HZ</u>	<u>TOTAL AMPS</u>	<u>TYPICAL ELECTRICAL CIRCUIT</u>
208	3	50	19 A	25 AMP
220	3	50	19 A	25 AMP
230	3	50	19 A	25 AMP
380	3	50	7 A	15 AMP
415	3	50	8 A	15 AMP
440	3	50	8 A	15 AMP
208	1	60	19 A	25 AMP
230	1	60	19 A	25 AMP
200	3	60	13 A	20 AMP
208	3	60	13 A	20 AMP
230	3	60	13 A	20 AMP
380	3	60	13 A	20 AMP
460	3	60	7 A	15 AMP
600	3	60	8 A	15 AMP

NOTE: Always refer to the machine data plate for specific electrical and water requirements. The material provided on this page is for reference only and may be subject to change without notice.

D226 STEAM BOOSTER

ELECTRICAL REQUIREMENTS:

VOLTAGE (V)	200-230
FREQUENCY (HZ)	50/60
PHASE	SINGLE

WATER REQUIREMENTS:

INCOMING WATER TEMPERATURE (MINIMUM)	110°F
FLOW PRESSURE (PSI)	20±5

STEAM REQUIREMENTS:

INCOMING STEAM PRESSURE (PSIG)	15-25
--------------------------------	-------

HEAT EXCHANGER SPECIFICATIONS:*

TUBESIDE WORKING PRESSURE (PSI)	125
SHELLSIDE WORKING PRESSURE (PSI)	125
TUBESIDE HYDROSTATIC TEST PRESSURE (PSI)	250
SHELLSIDE HYDROSTATIC TEST PRESSURE (PSI)	188
MAXIMUM OPERATING TEMPERATURE	295°F
MAXIMUM SHELLSIDE STEAM PRESSURE (PSI)	125

* - Indicates typical design criteria but is subject to change without notice. For more information, contact your authorized Jackson service representative.

STEAM RELIEF VALVE SET PRESSURE (PSI):	50
WATER OUTLET SAFETY VALVE SET PRESSURE (PSI):	125

SECTION 1: SPECIFICATION INFORMATION

AJ-44 ELECTRIC - LEFT TO RIGHT

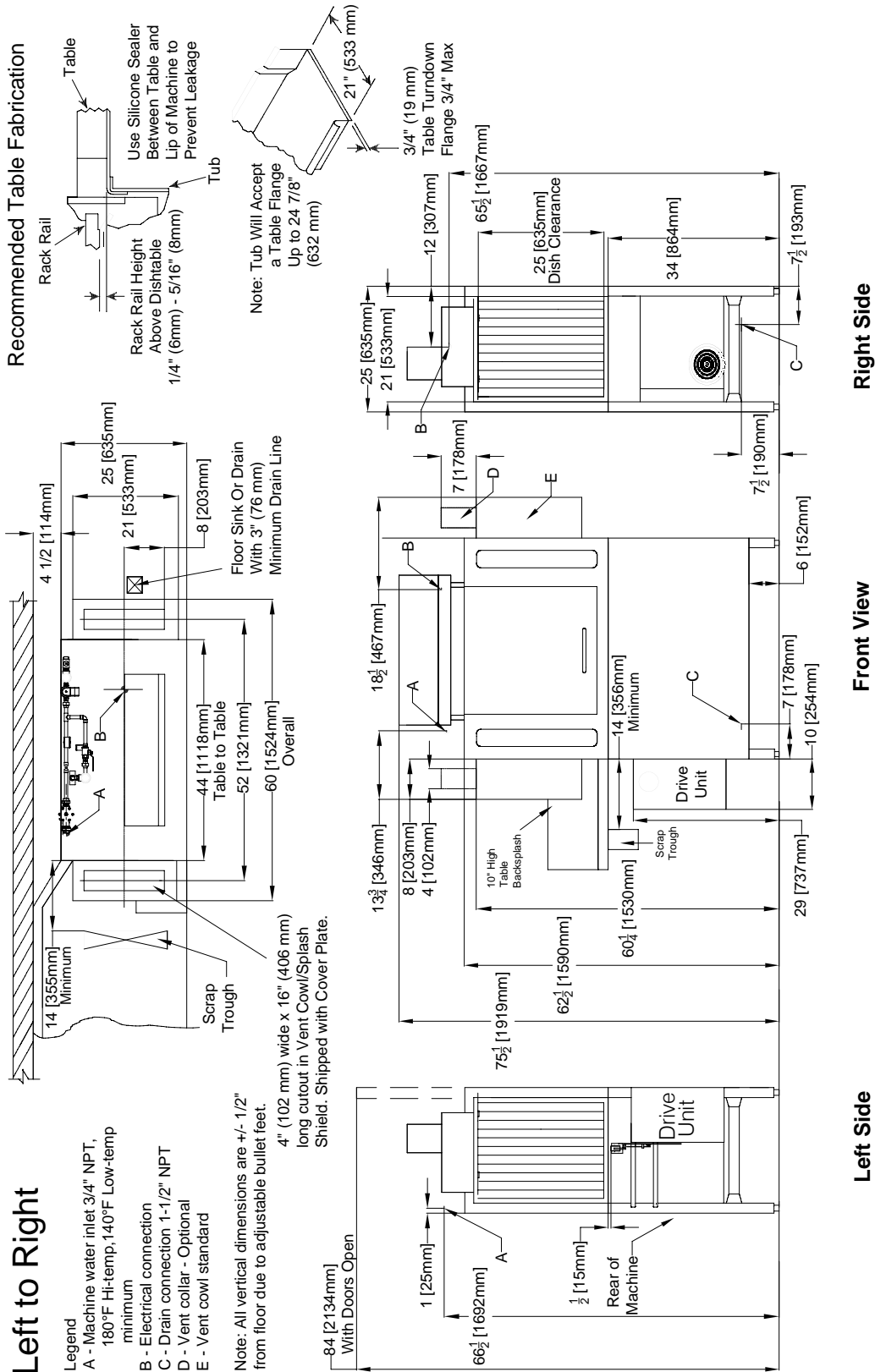

SECTION 1: SPECIFICATION INFORMATION

AJ-44 ELECTRIC - RIGHT TO LEFT

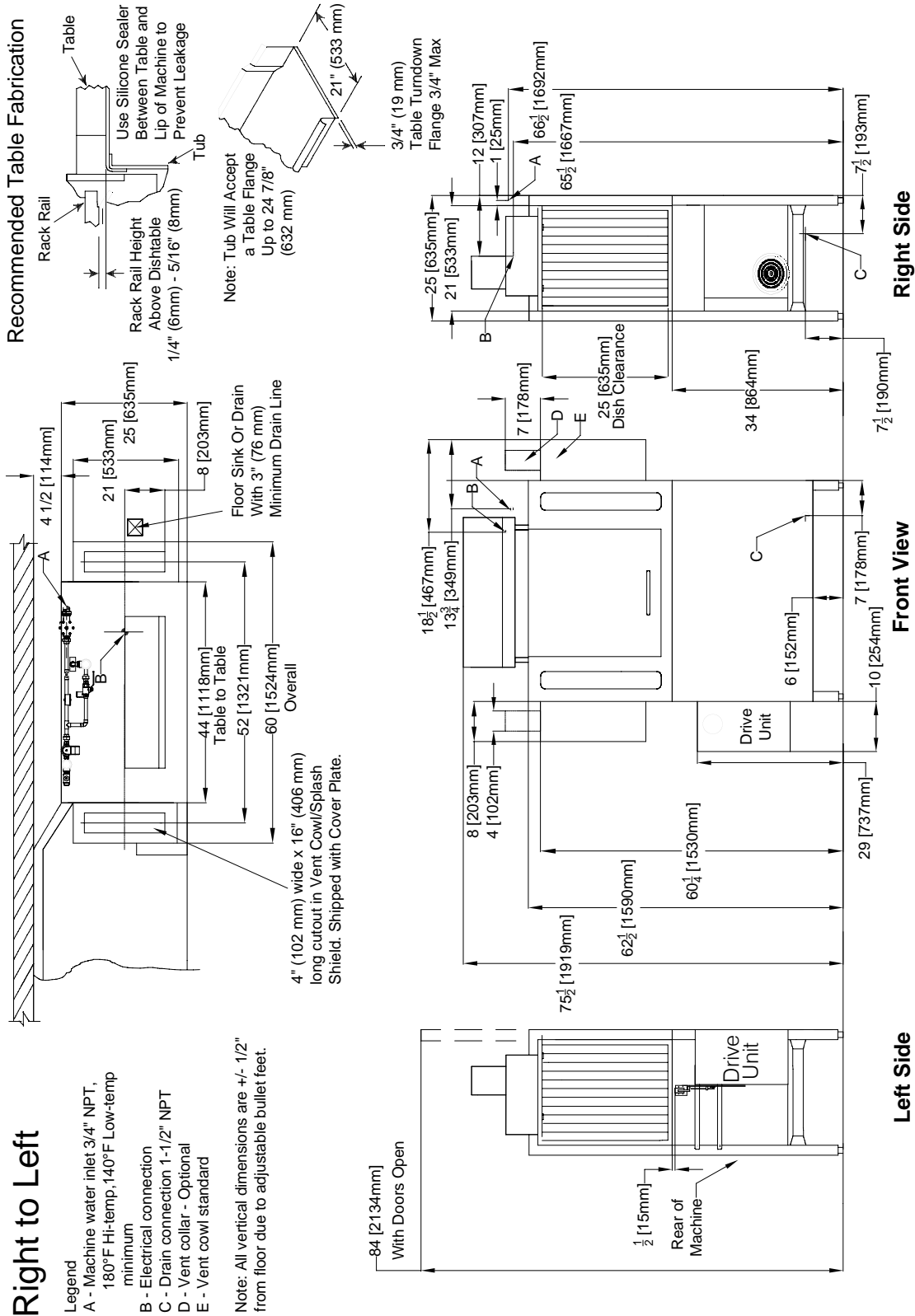

SECTION 1: SPECIFICATION INFORMATION

AJ-44 GAS - LEFT TO RIGHT

Left to Right

Legend to Drawing

- A - Machine water inlet 3/4" NPT, 180°F Hi-temp, 140°F Low-temp minimum
- B - Electrical connection
- C - Drain connection 1-1/2" NPT
- D - Vent collar - Optional
- E - Vent cowl standard
- F - 3/4" NPT 180°F Water Inlet for wash tank fill, final rinse, & tank heating. From gas booster heater. Interconnecting hose provided by manufacturer.
- G - 3/4" NPT 140°F Water Inlet for gas booster heater.
- H - 3/4" NPT 180°F Water Outlet connection to line on dishmachine. Connection hose provided by manufacturer.
- J - 3/4" NPT Gas Connection
- K - 4" OD Vent pipe connection. Flue to be installed to meet local codes by installing contractor.

Note: All vertical dimensions are +/- 1/2" from floor due to adjustable bullet feet.

Recommended Table Fabrication

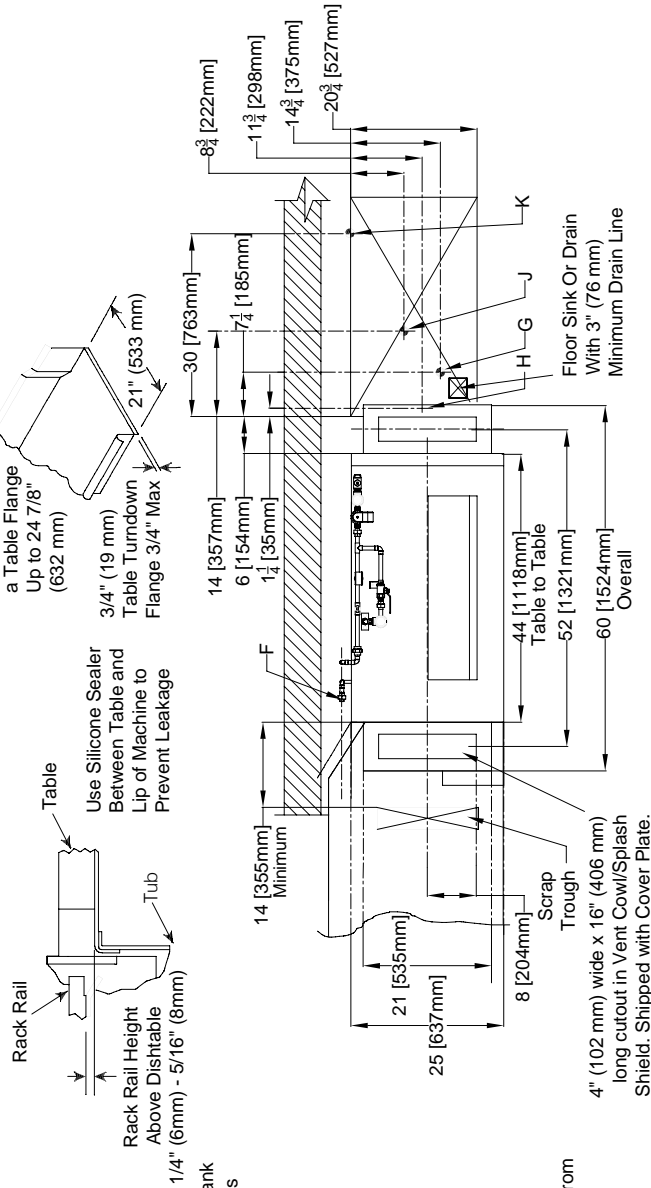

Note: Tub Will Accept a Table Flange Up to 24 7/8" (632 mm)

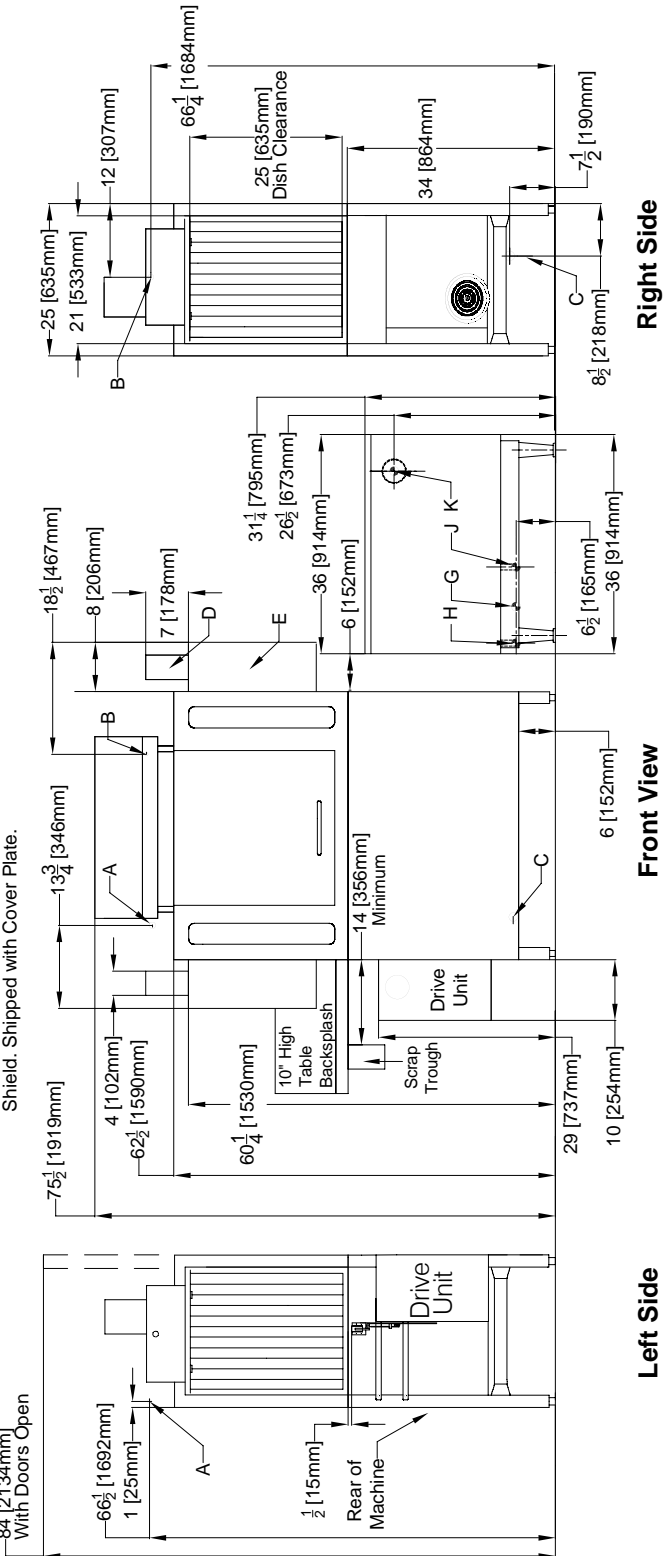
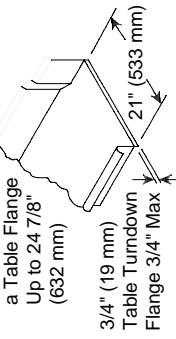

SECTION 1: SPECIFICATION INFORMATION

AJ-44 GAS - RIGHT TO LEFT

Recommended Table Fabrication

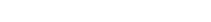
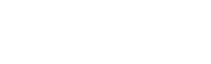
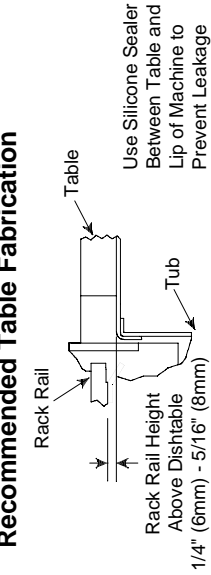
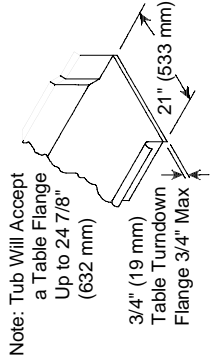

Legend to Drawing

- A - Machine water inlet 3/4" NPT, 180°F Hi-temp, 140°F Low-temp minimum
- B - Electrical connection
- C - Drain connection 1-1/2" NPT
- D - Vent collar - Optional
- E - Vent cowl standard
- F - 3/4" NPT 180°F Water Inlet for wash tank fill, final rinse, & tank heating. From gas booster heater. Interconnecting hose provided by manufacturer.
- G - 3/4" NPT 140°F Water inlet for gas booster heater.
- H - 3/4" NPT 180°F Water Outlet connection to line on dishmachine. Connection hose provided by manufacturer.
- J - 3/4" NPT Gas Connection
- K - 4" OD Vent pipe connection. Flue to be installed to meet local codes by installing contractor.

Note: All vertical dimensions are +/- 1/2" from floor due to adjustable bullet feet.

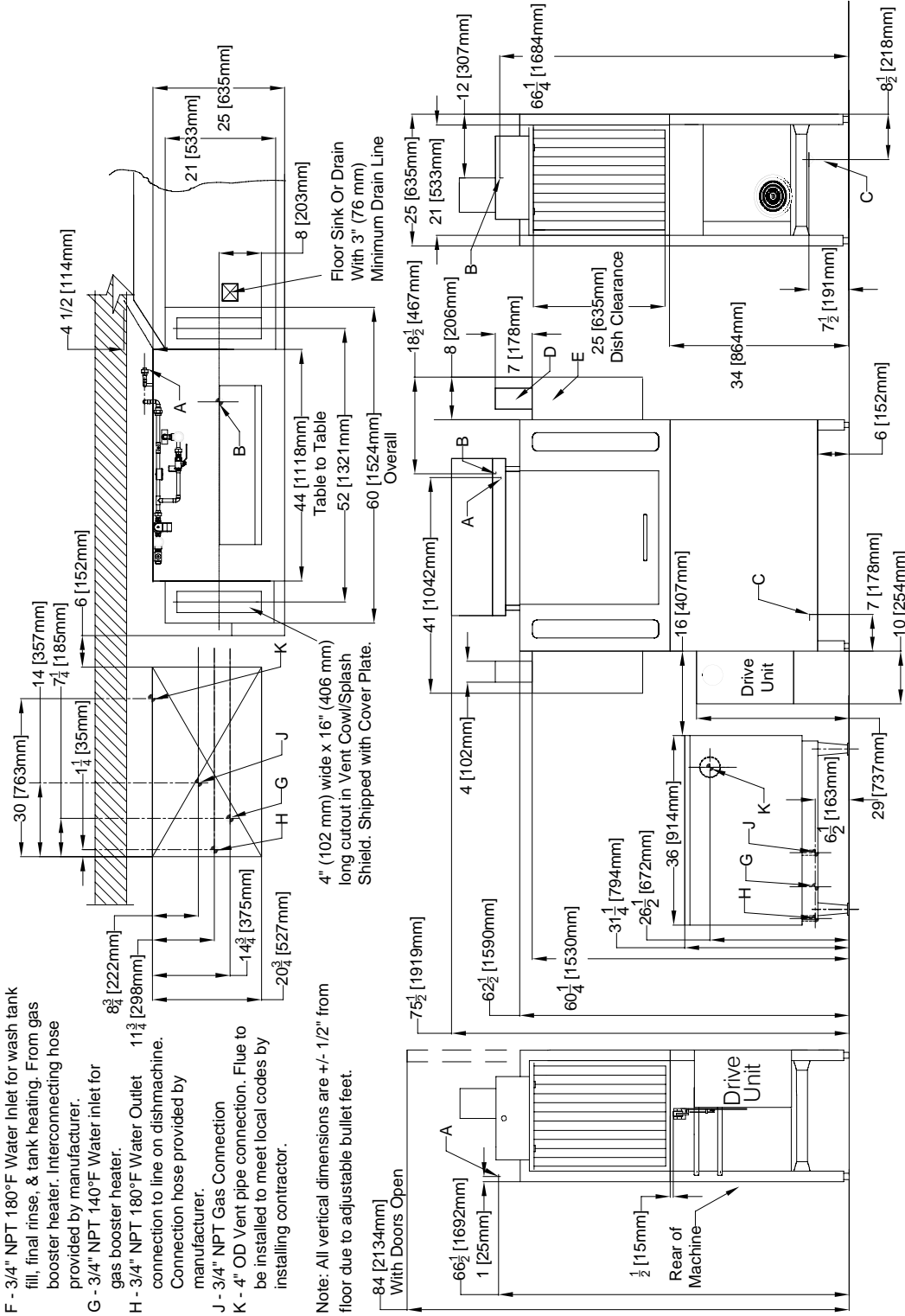

Right Side

Front View

Left Side

SECTION 1: SPECIFICATION INFORMATION

AJ-44 STEAM - RIGHT TO LEFT

Right to Left

Legend

- A - Machine water inlet 3/4" NPT 180°F Hi-temp, 140°F Low-temp minimum
- B - Electrical connection
- C - Drain connection 1-1/2" NPT
- D - Vent collar - Optional
- E - Vent cowl standard
- F - 3/4" NPT Steam connection
- G - 3/4" NPT Condensate return
- H - Steam electrical connection
- J - 1" NPT Steam connection
- K - 3/4" Condensate connection
- L - 3/4" NPT Incoming 110°F water connection
- M - 3/4" NPT 180°F water to dishmachine.

Note: All vertical dimensions are +/- 1/2" from floor due to adjustable bullet feet.

Recommended Table Fabrication

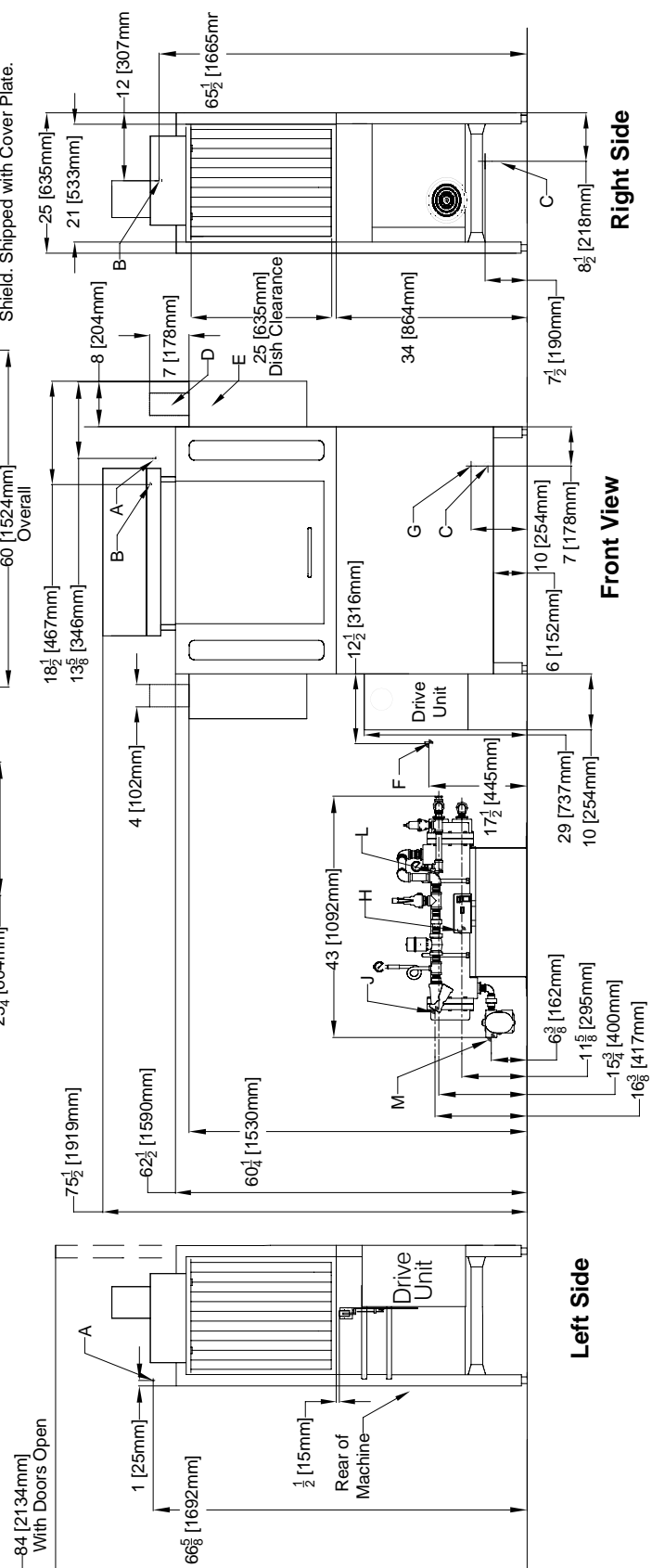
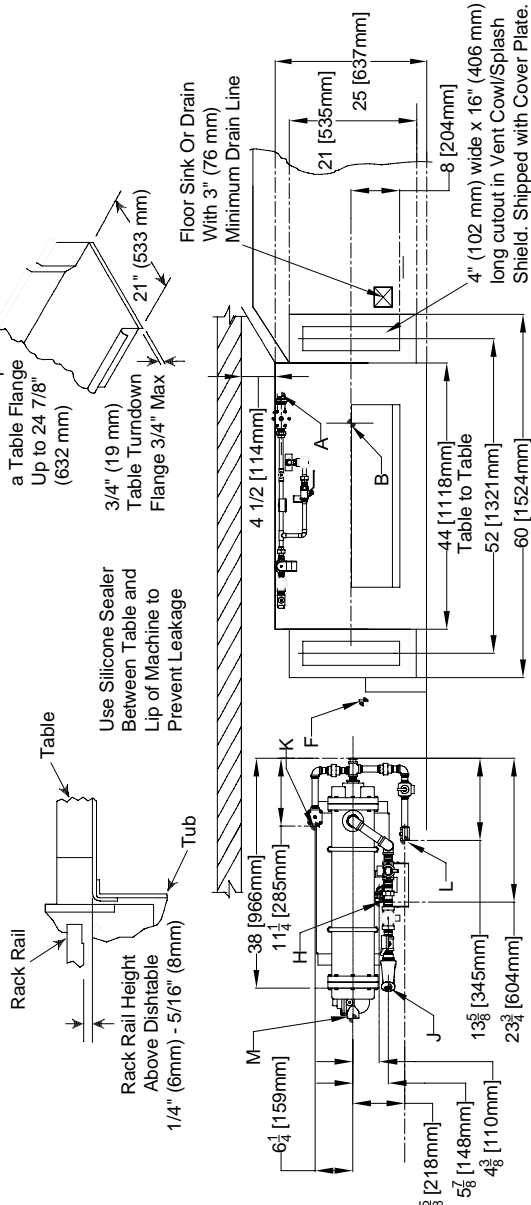

SECTION 1: SPECIFICATION INFORMATION

AJ-66 ELECTRIC - LEFT TO RIGHT

Left to Right

Legend

- A - Machine water inlet 3/4" NPT, 180°F Hi-temp, 140°F Low-temp minimum
- B - Electrical connection
- C - Drain connection 1-1/2" NPT
- D - Vent collar - Optional
- E - Vent cowl standard
- F - Prewash water inlet 3/4" NPT 110°F-140°F
- G - Cold water thermostat plumbing connection 3/4" NPT - Optional

Note: All vertical dimensions are +/- 1/2" from floor due to adjustable bullet feet.

Recommended Table Fabrication

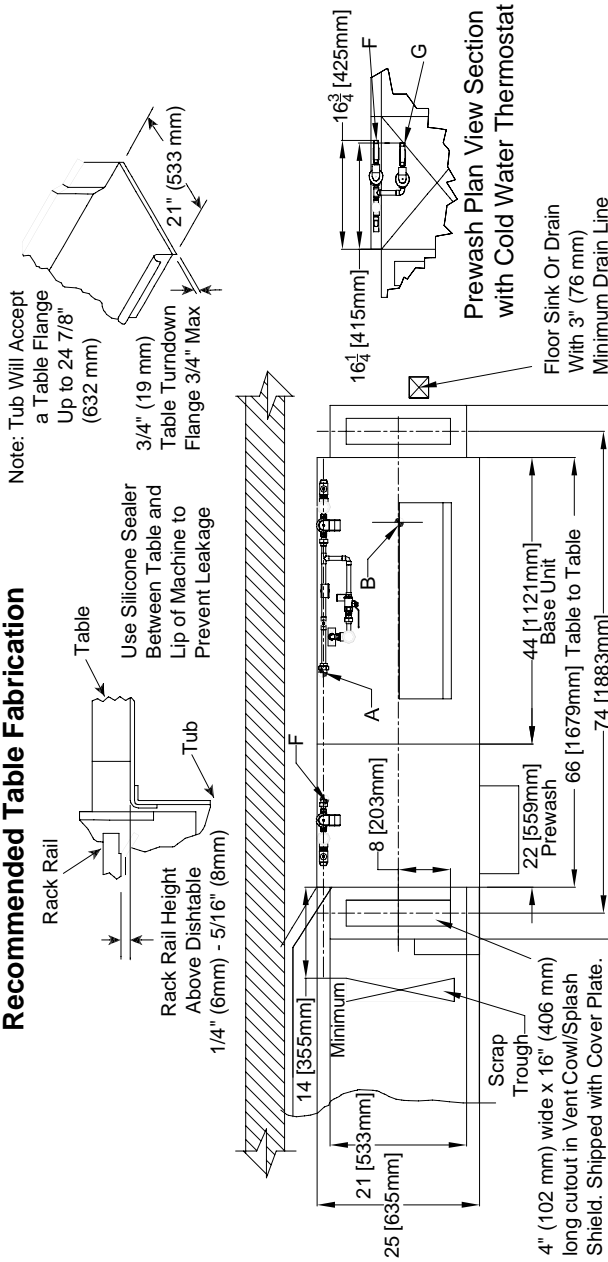

Right Side

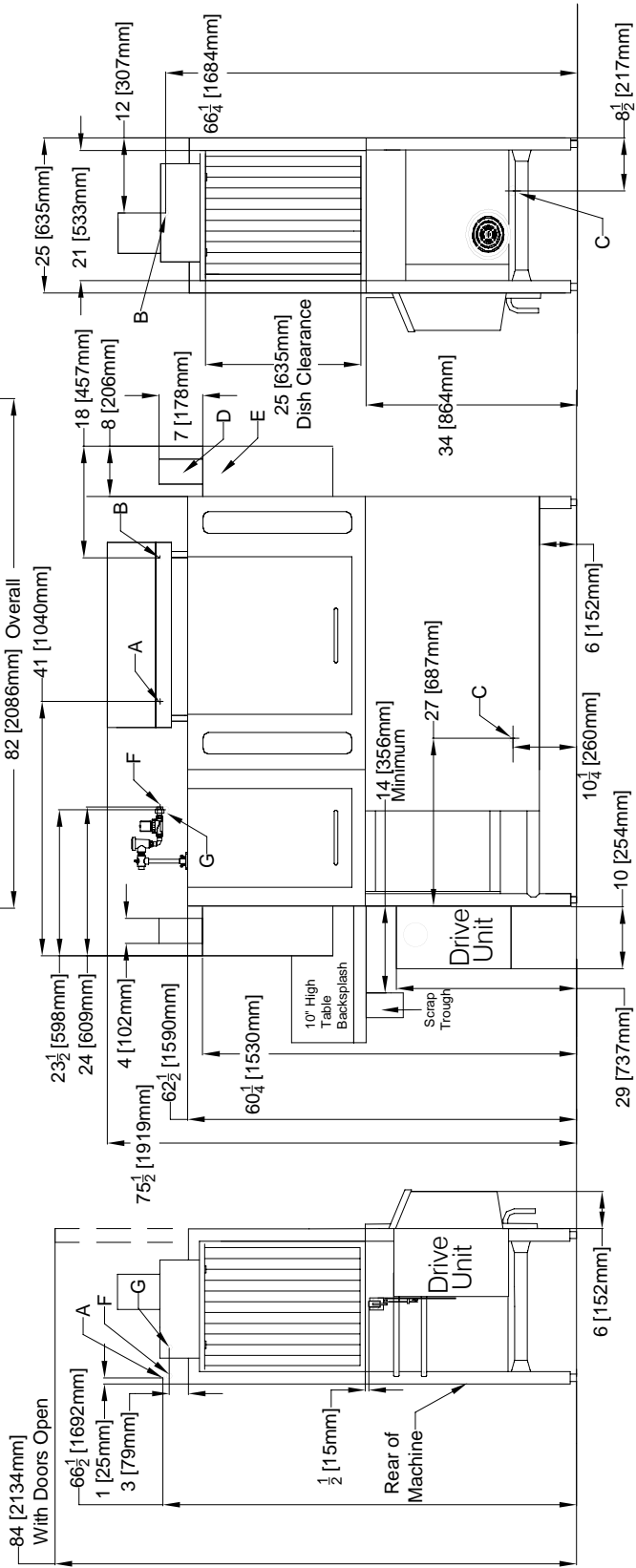

Front View

Left Side

SECTION 1: SPECIFICATION INFORMATION

AJ-66 ELECTRIC - RIGHT TO LEFT

Right to Left

Legend

- A - Machine water inlet 3/4" NPT, 180°F Hi-temp, 140°F Low-temp minimum
- B - Electrical connection
- C - Drain connection 1-1/2" NPT
- D - Vent collar - Optional
- E - Vent cowl standard
- F - Prewash water inlet 3/4" NPT 110°F-140°F
- G - Cold water thermostat plumbing connection 3/4" NPT - Optional

Note: All vertical dimensions are +/- 1/2" from floor due to adjustable bullet feet.

4" (102 mm) wide x 16" (406 mm) long cutout in Vent Cowl/Splash Shield. Shipped with Cover Plate.

Recommended Table Fabrication

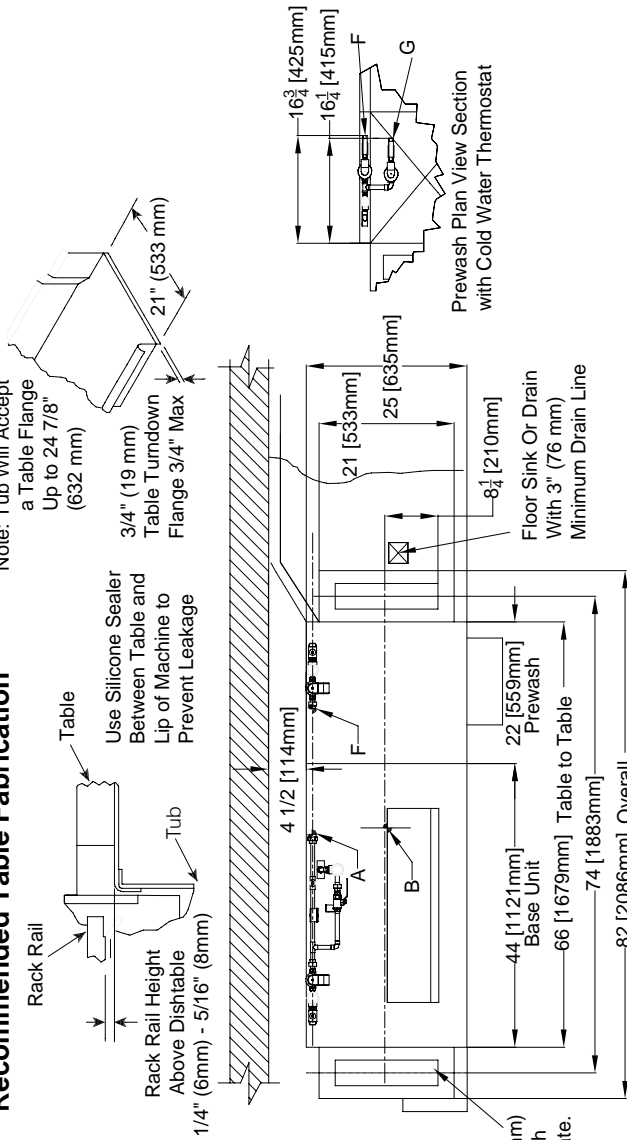

Note: Tub Will Accept a Table Flange Up to 24 7/8" (632 mm)

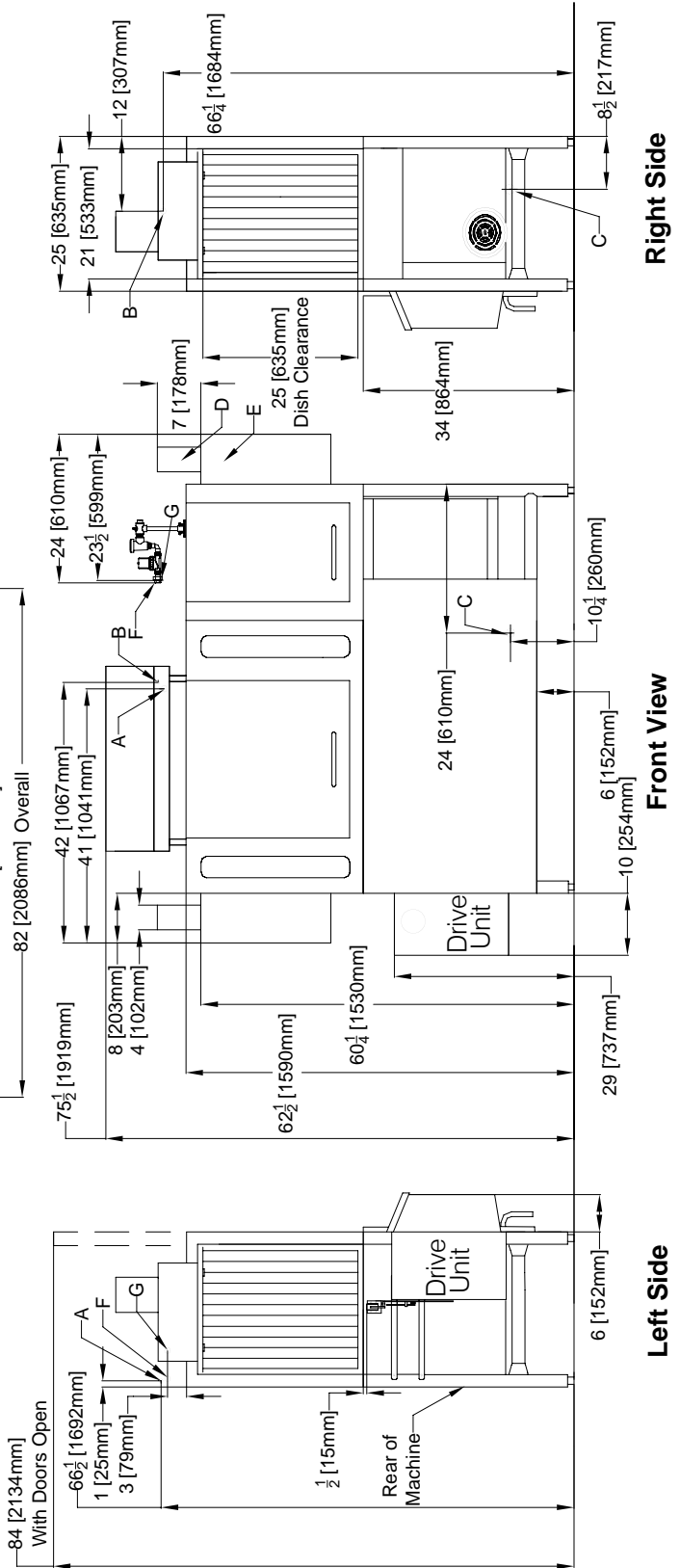
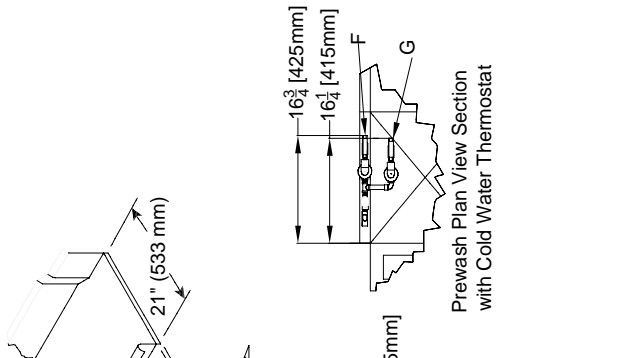

Right Side

Front View

Left Side

SECTION 1: SPECIFICATION INFORMATION

AJ-66 GAS - LEFT TO RIGHT

Left to Right

Legend

- A - Machine water inlet 3/4" NPT, 180°F Hi-temp, 140°F Low-temp minimum
- B - Electrical connection
- C - Drain connection 1-1/2" NPT
- D - Vent collar - Optional
- E - Vent cowl standard
- F - 3/4" NPT 180°F Water Inlet for wash tank fill, final rinse, & tank heating. From gas booster heater. Interconnecting hose provided by manufacturer.
- G - 3/4" NPT 140°F Water inlet for gas booster heater.
- H - 3/4" NPT 180°F Water Outlet connection to line on dishmachine. Connection hose provided by manufacturer.
- J - 3/4" NPT Gas Connection
- K - 4" OD Vent pipe connection. Flue to be installed to meet local codes by installing contractor.
- L - Prewash water inlet 3/4" NPT 110°F-140°F
- M - Cold water thermostat plumbing connection 3/4" NPT - Optional

Recommended Table Fabrication

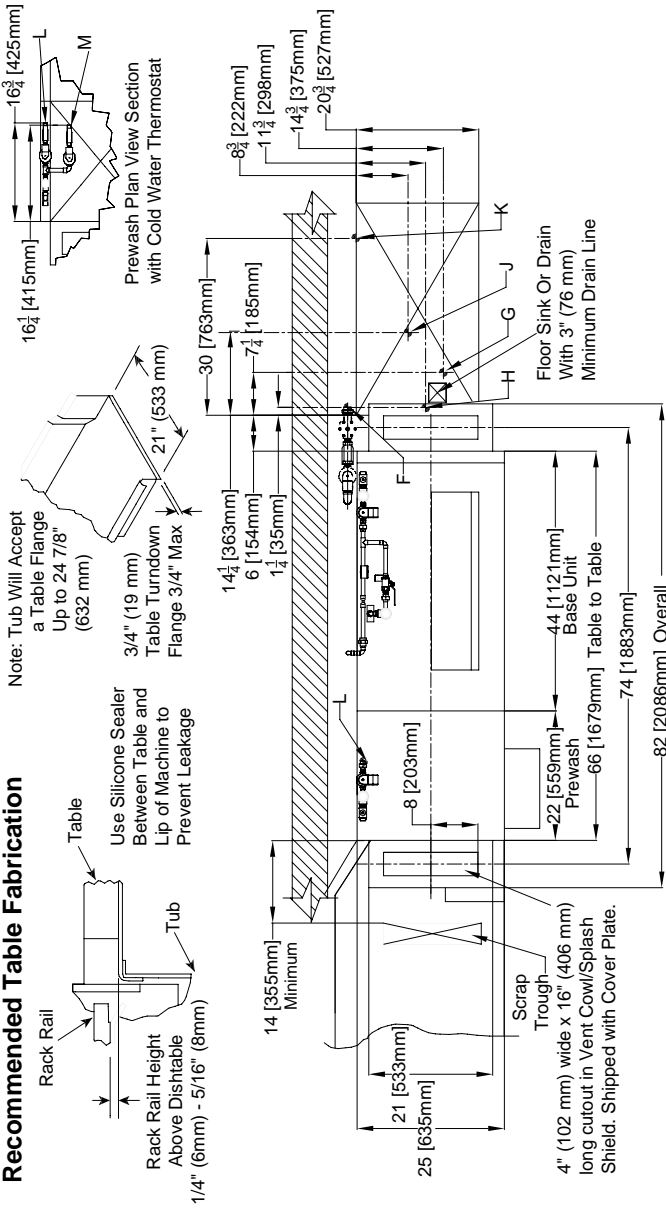

Note: All vertical dimensions are +/- 1/2" from floor due to adjustable bullet feet.

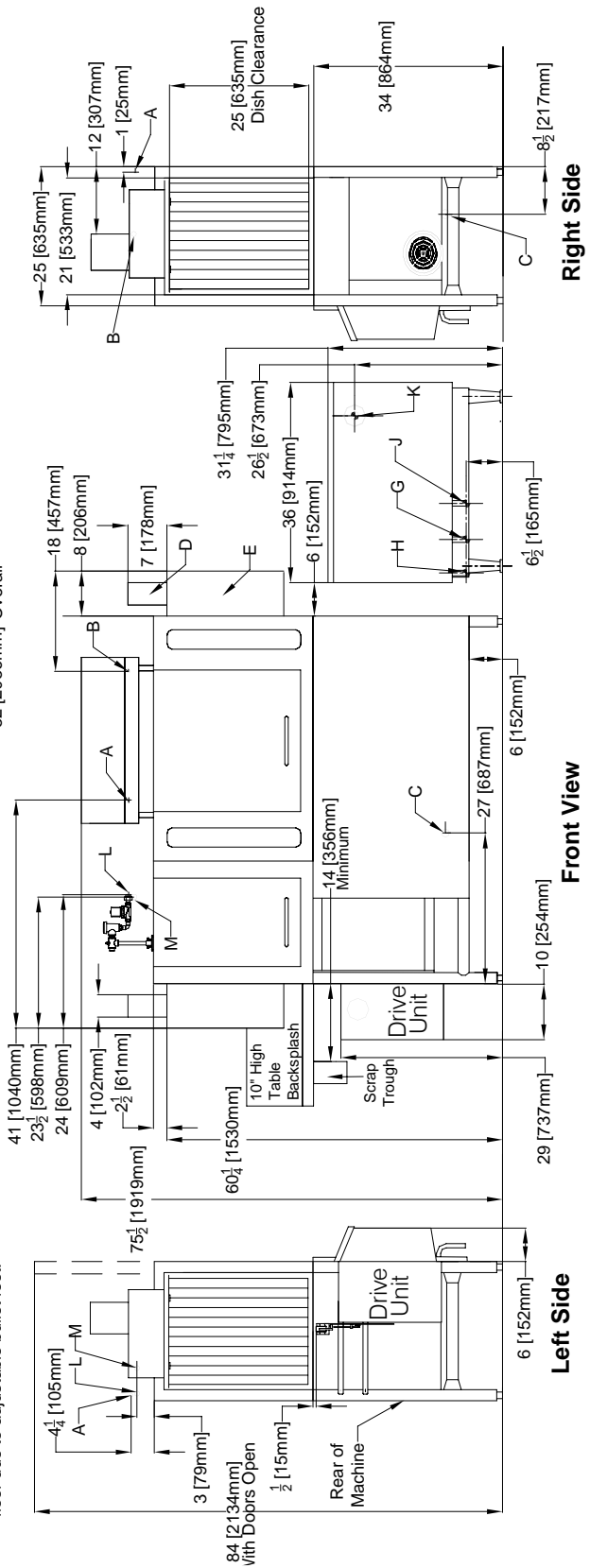

SECTION 1: SPECIFICATION INFORMATION

AJ-66 STEAM - LEFT TO RIGHT

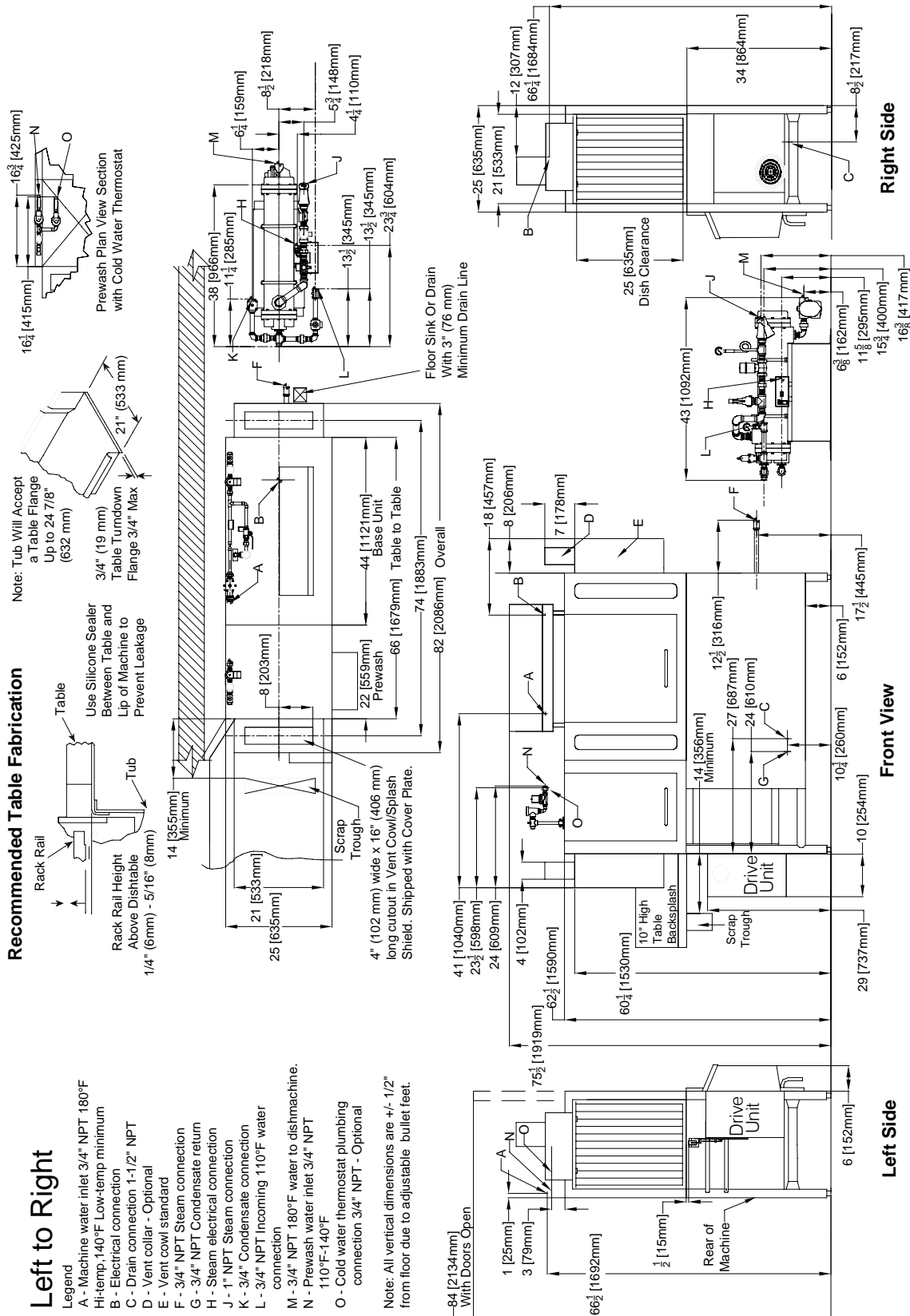

SECTION 1: SPECIFICATION INFORMATION

AJ-80 ELECTRIC - LEFT TO RIGHT

Recommended Table Fabrication

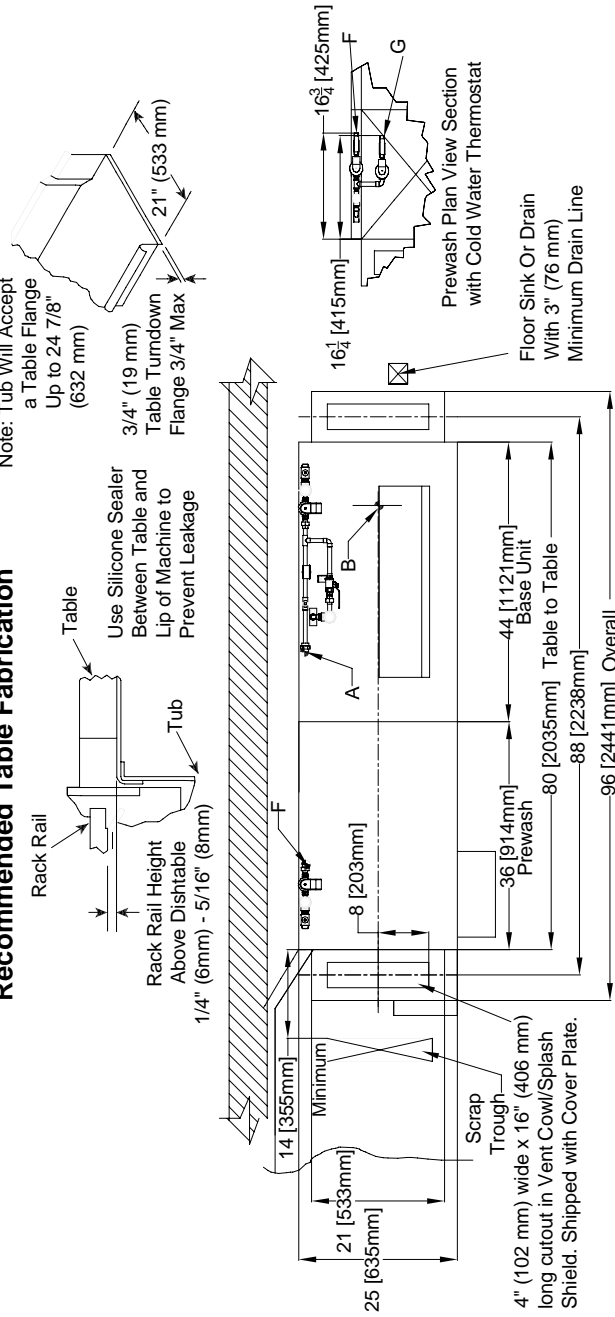

Left to Right

- Legend
- A - Machine water inlet 3/4" NPT, 180°F Hi-temp, 140°F Low-temp minimum
 - B - Electrical connection
 - C - Drain connection 1-1/2" NPT
 - D - Vent collar - Optional
 - E - Vent cowl standard
 - F - Prewash water inlet 3/4" NPT 110°F-140°F
 - G - Cold water thermostat plumbing connection 3/4" NPT - Optional

Note: All vertical dimensions are +/- 1/2" from floor due to adjustable bullet feet.

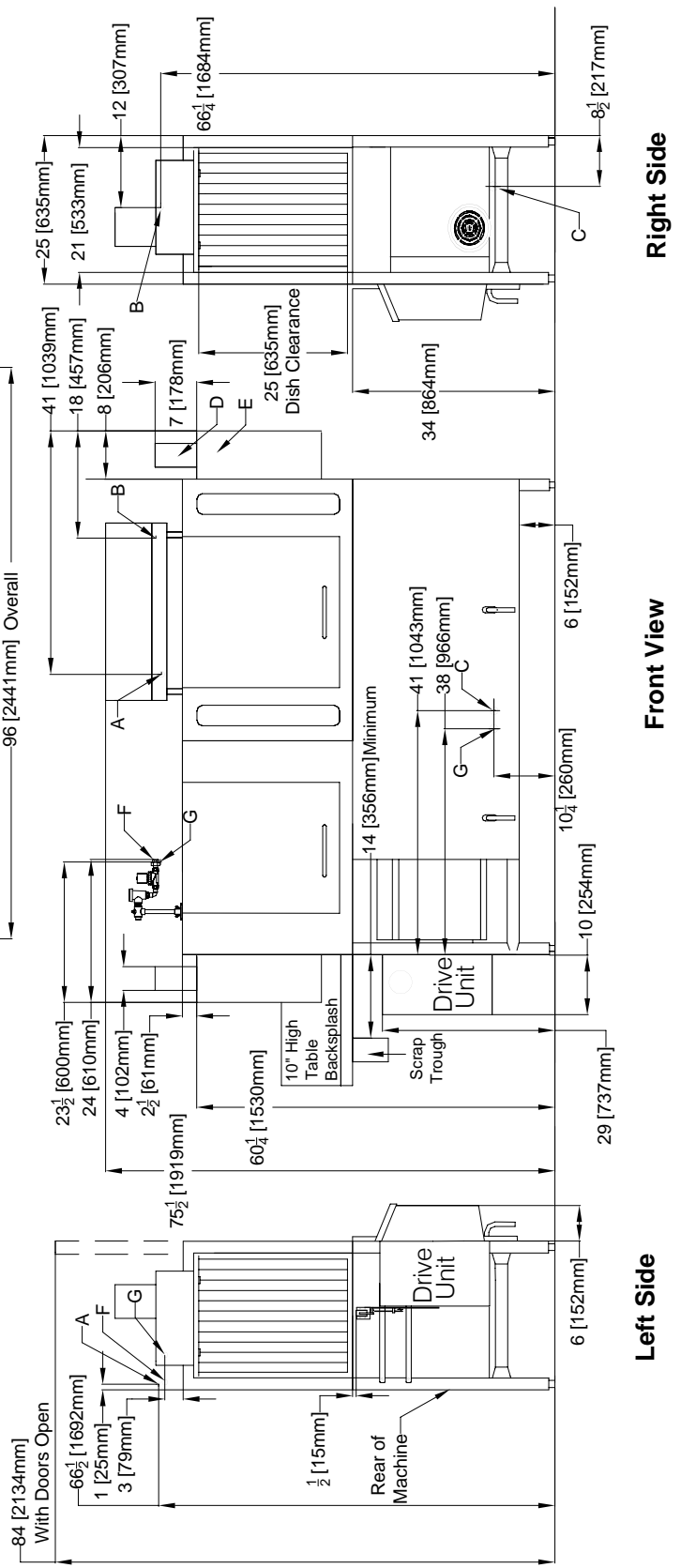

SECTION 1: SPECIFICATION INFORMATION

AJ-80 GAS - LEFT TO RIGHT

Left to Right

Legend

- A - Machine water inlet, 3/4" NPT, 180°F Hi-temp, 140°F Low-temp minimum
- B - Electrical connection
- C - Drain connection, 1-1/2" NPT
- D - Vent collar - Optional
- E - Vent cowi standard
- F - 3/4" NPT, 180°F Water Inlet for wash tank fill, final rinse, & tank heating. From gas booster heater. Interconnecting hose provided by manufacturer.
- G - 3/4" NPT, 140°F Water Inlet for gas booster heater.
- H - 3/4" NPT, 180°F Water Outlet connection to line on dishmachine. Connection hose provided by manufacturer.
- J - 3/4" NPT Gas Connection
- K - 4" OD Vent pipe connection. Flue to be installed to meet local codes by installing contractor.
- L - Prewash water inlet, 3/4" NPT, 110°F-140°F
- M - Cold water thermostat plumbing connection, 3/4" NPT - Optional

Note: All vertical dimensions are +/- 1/2" from floor due to adjustable bullet feet.

Recommended Table Fabrication

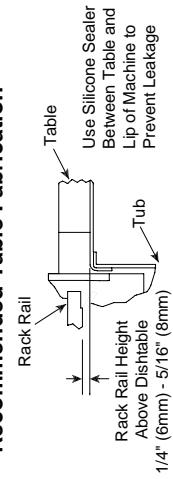

Note: Tub Will Accept a Table Flange Up to 24 7/8\" (632 mm)

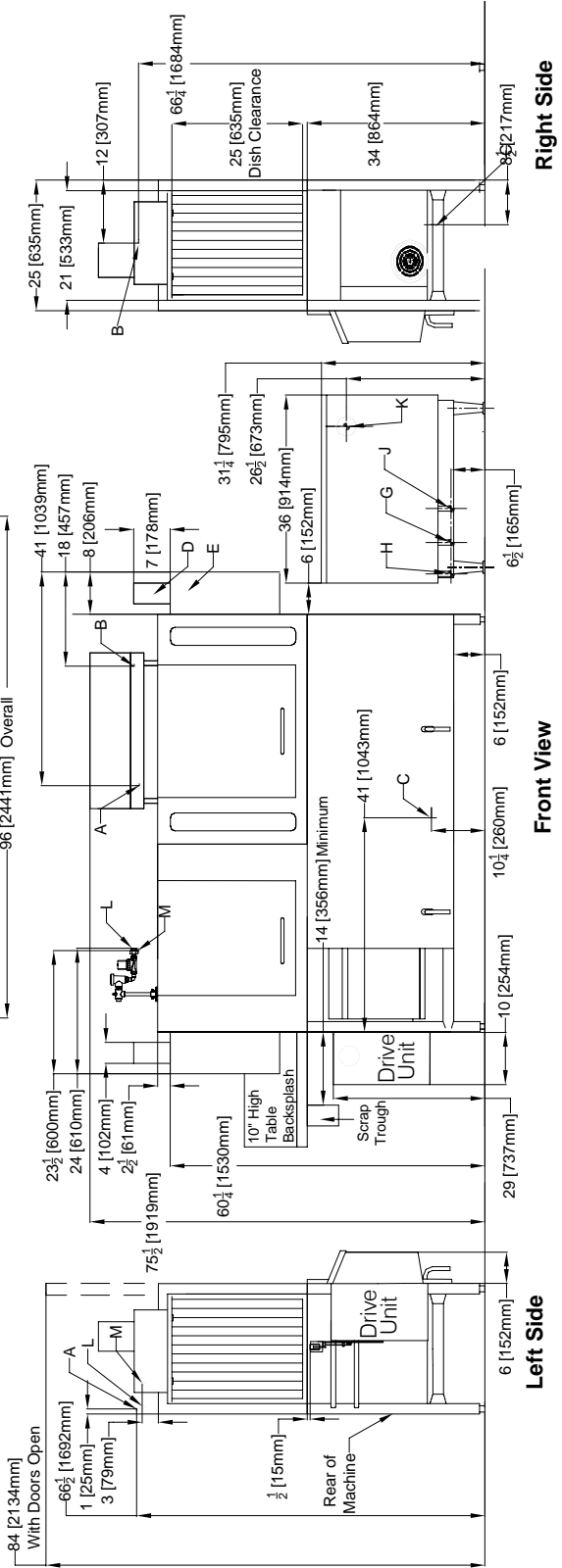
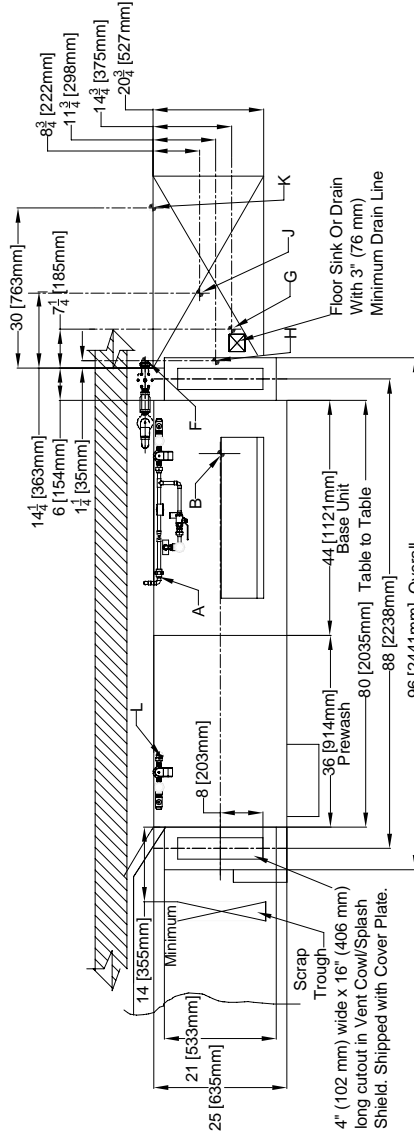
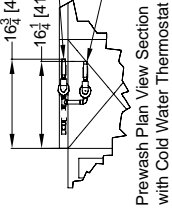

SECTION 1: SPECIFICATION INFORMATION

AJ-80 GAS - RIGHT TO LEFT

Right to Left

- Legend**
- A - Machine water inlet 3/4" NPT, 180°F Hi-temp, 140°F Low-temp minimum
 - B - Electrical connection
 - C - Drain connection 1-1/2" NPT
 - D - Vent collar - Optional
 - E - Vent cowl standard
 - F - 3/4" NPT 180°F Water Inlet for wash tank fill, final rinse, & tank heating. From gas booster heater. Interconnecting hose provided by manufacturer.
 - G - 3/4" NPT 140°F Water inlet for gas booster heater.
 - H - 3/4" NPT 180°F Water Outlet connection to line on dishmachine.
 - I - Connection hose provided by manufacturer.
 - J - 3/4" NPT Gas Connection
 - K - 4" OD Vent pipe connection. Flue to be installed to meet local codes by installing contractor.
 - L - Prewash water inlet 3/4" NPT 110°F-140°F
 - M - Cold water thermostat plumbing connection 3/4" NPT - Optional

Note: All vertical dimensions are +/- 1/2" from floor due to adjustable bullet feet.

Recommended Table Fabrication

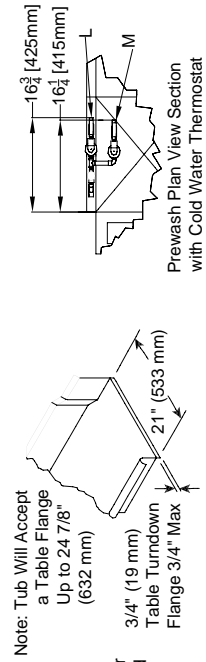

Prewash Plan View Section with Cold Water Thermostat

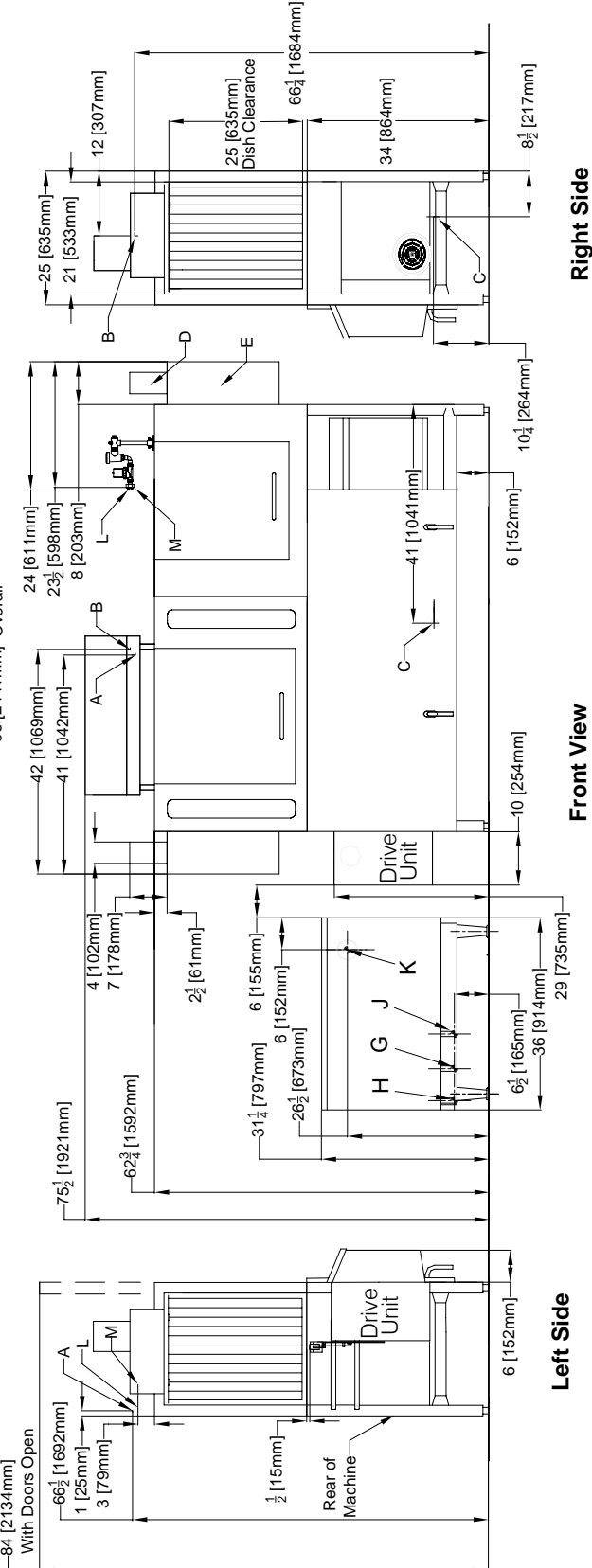
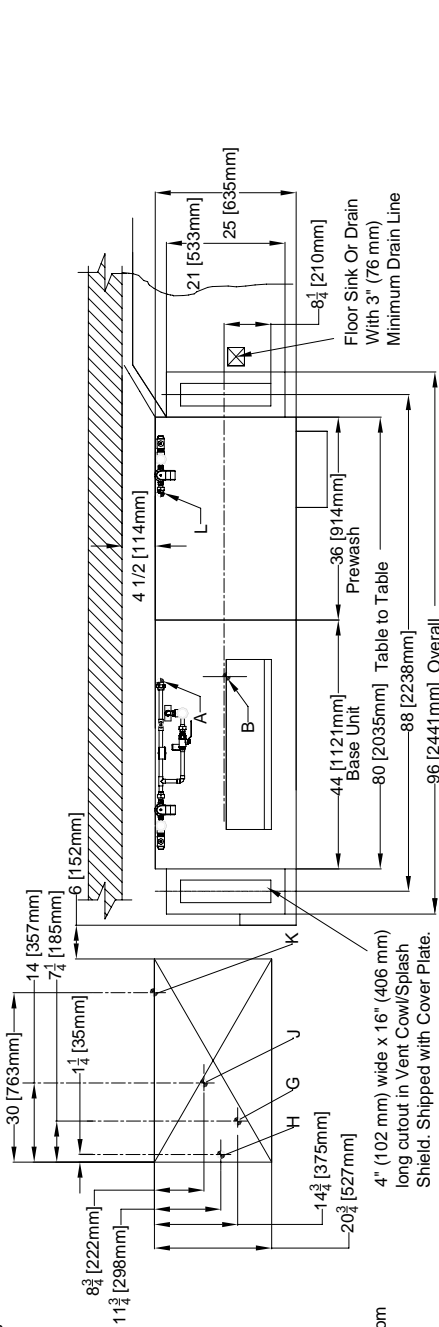

SECTION 1: SPECIFICATION INFORMATION

AJ-80 STEAM - LEFT TO RIGHT

Left to Right

- Legend**
- A - Machine water inlet 3/4" NPT 180°F Hi-temp, 140°F Low-temp minimum
 - B - Electrical connection
 - C - Drain connection 1-1/2" NPT
 - D - Vent collar - Optional
 - E - Vent cow standard
 - F - 3/4" NPT Steam connection
 - G - 3/4" NPT Condensate return
 - H - Steam electrical connection
 - J - 1" NPT Steam connection
 - K - 3/4" Condensate connection
 - L - 3/4" NPT Incoming 110°F water connection
 - M - 3/4" NPT 180°F water to dishmachine.
 - N - Prewash water inlet 3/4" NPT 110°F-140°F
 - O - Cold water thermostat plumbing connection 3/4" NPT - Optional

Note: All vertical dimensions are +/- 1/2" from floor due to adjustable bullet feet.

Recommended Table Fabrication

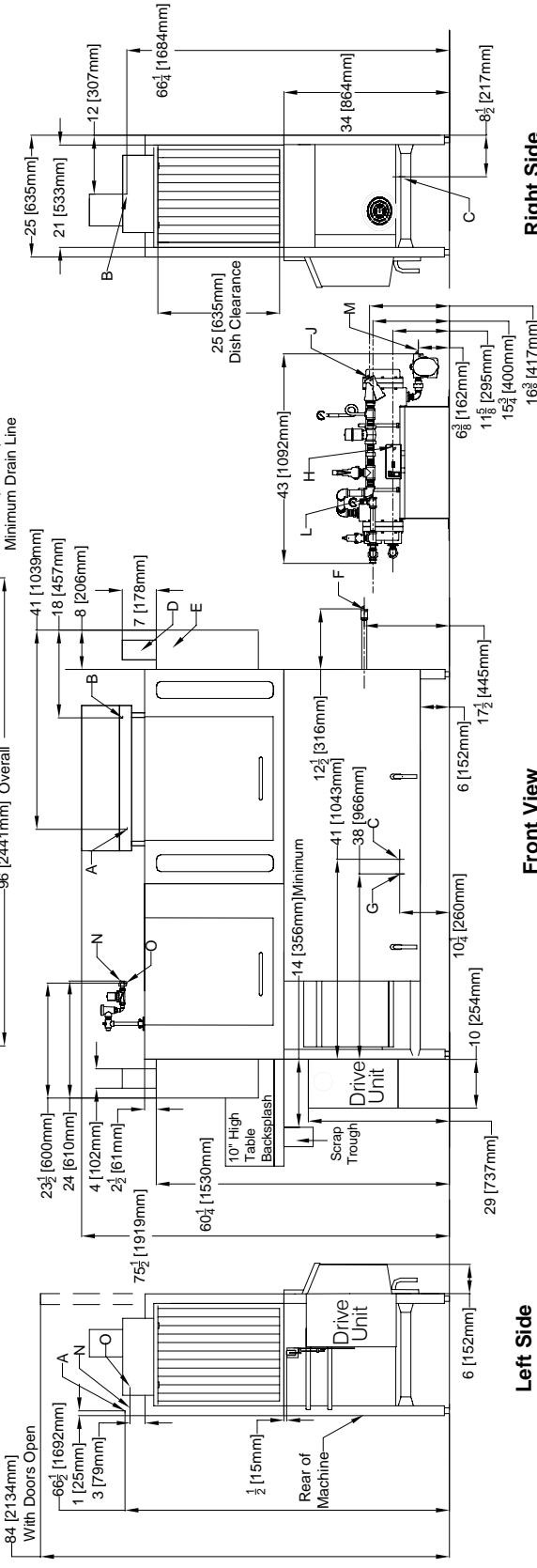
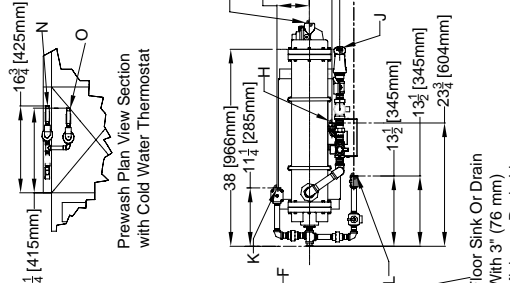
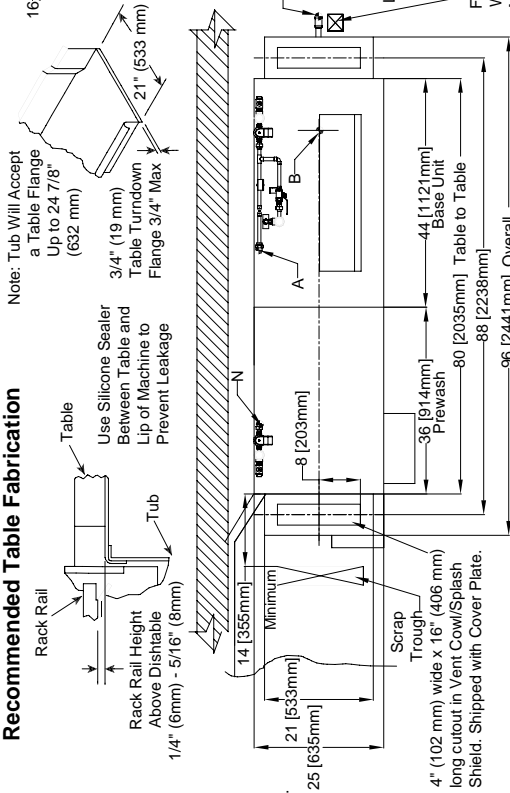

SECTION 1: SPECIFICATION INFORMATION

SIDE LOADER (LEFT TO RIGHT) DIMENSIONS

NOTE: ALL DIMENSIONS ARE TYPICAL.

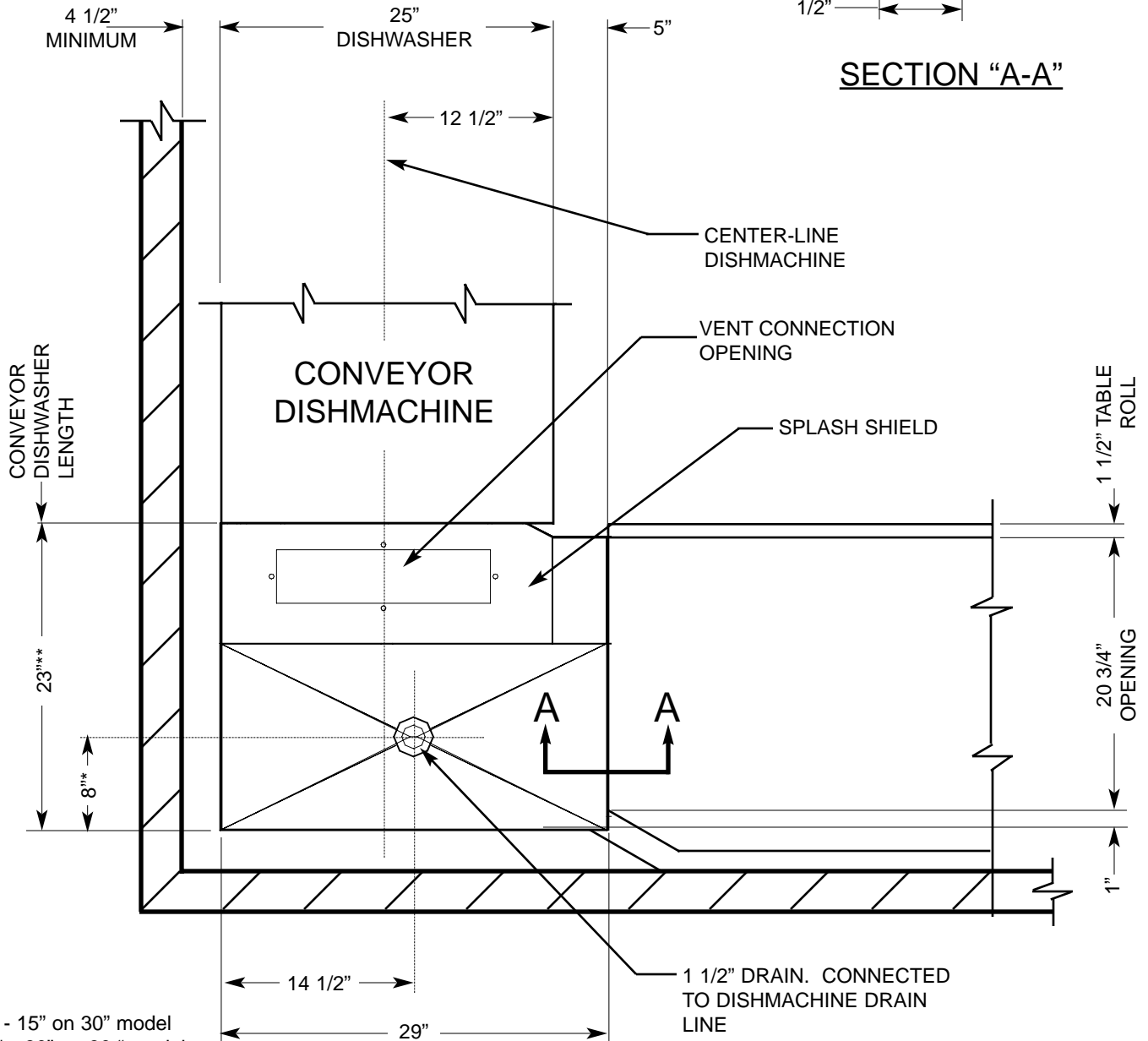
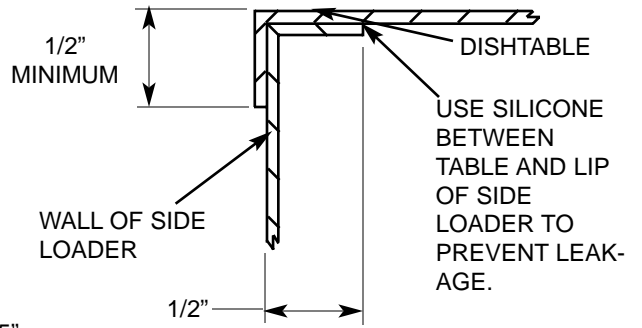

* - 15" on 30" model
 ** - 30" on 30" model

SECTION 1: SPECIFICATION INFORMATION

SIDE LOADER (RIGHT TO LEFT) DIMENSIONS

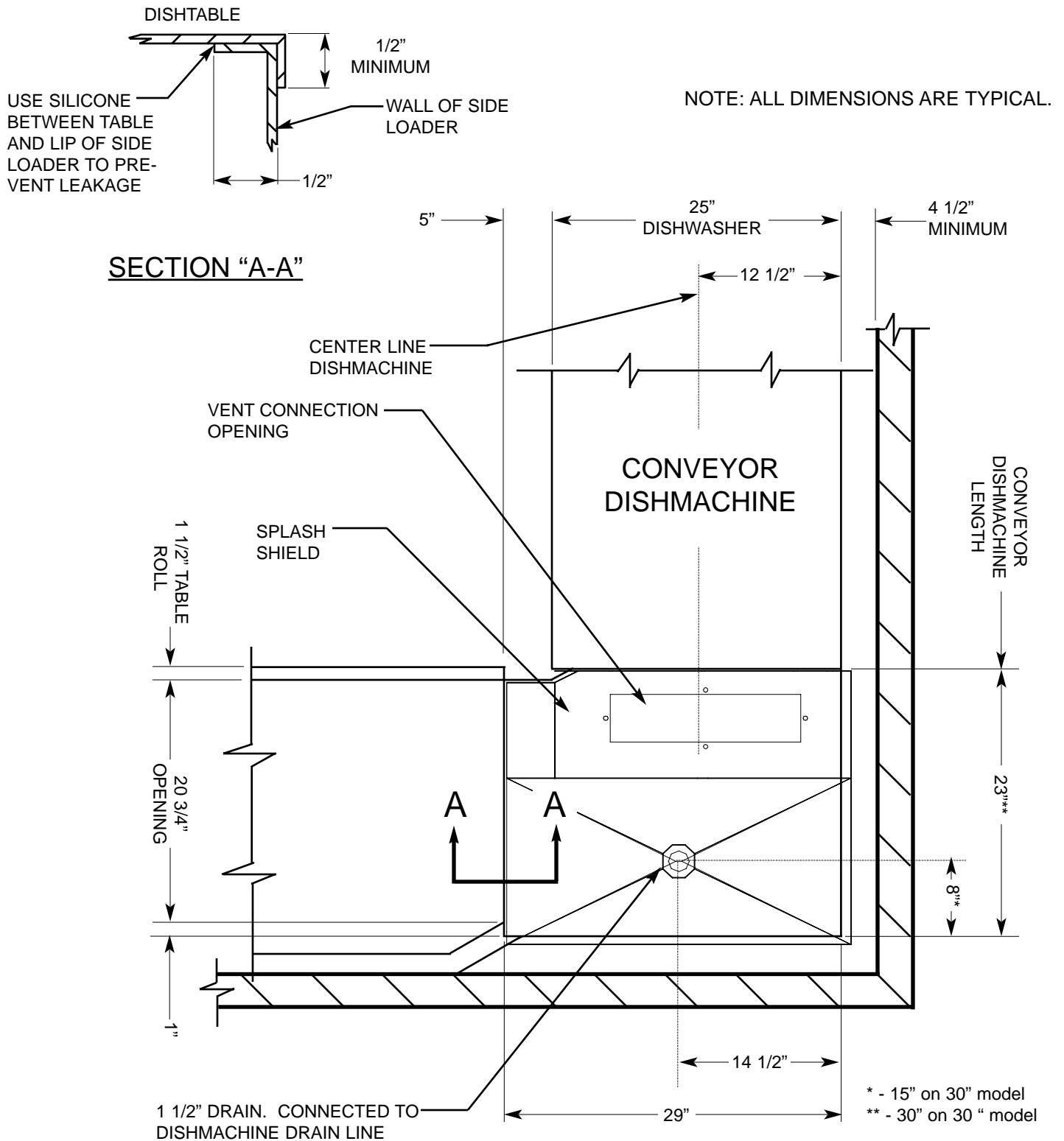

SECTION 1: SPECIFICATION INFORMATION

SIDE LOADER (INSTALLED) DIMENSIONS

23" SIDE LOADER DIMENSIONS

MODEL	DIMENSIONS
AJ-44	75"
AJ-66	97"
AJ-80	111"

30" SIDE LOADER DIMENSIONS

MODEL	DIMENSIONS
AJ-44	82"
AJ-66	104"
AJ-80	118"

NOTE: ALL DIMENSIONS ARE TYPICAL.

(Left to Right installation shown for reference.)

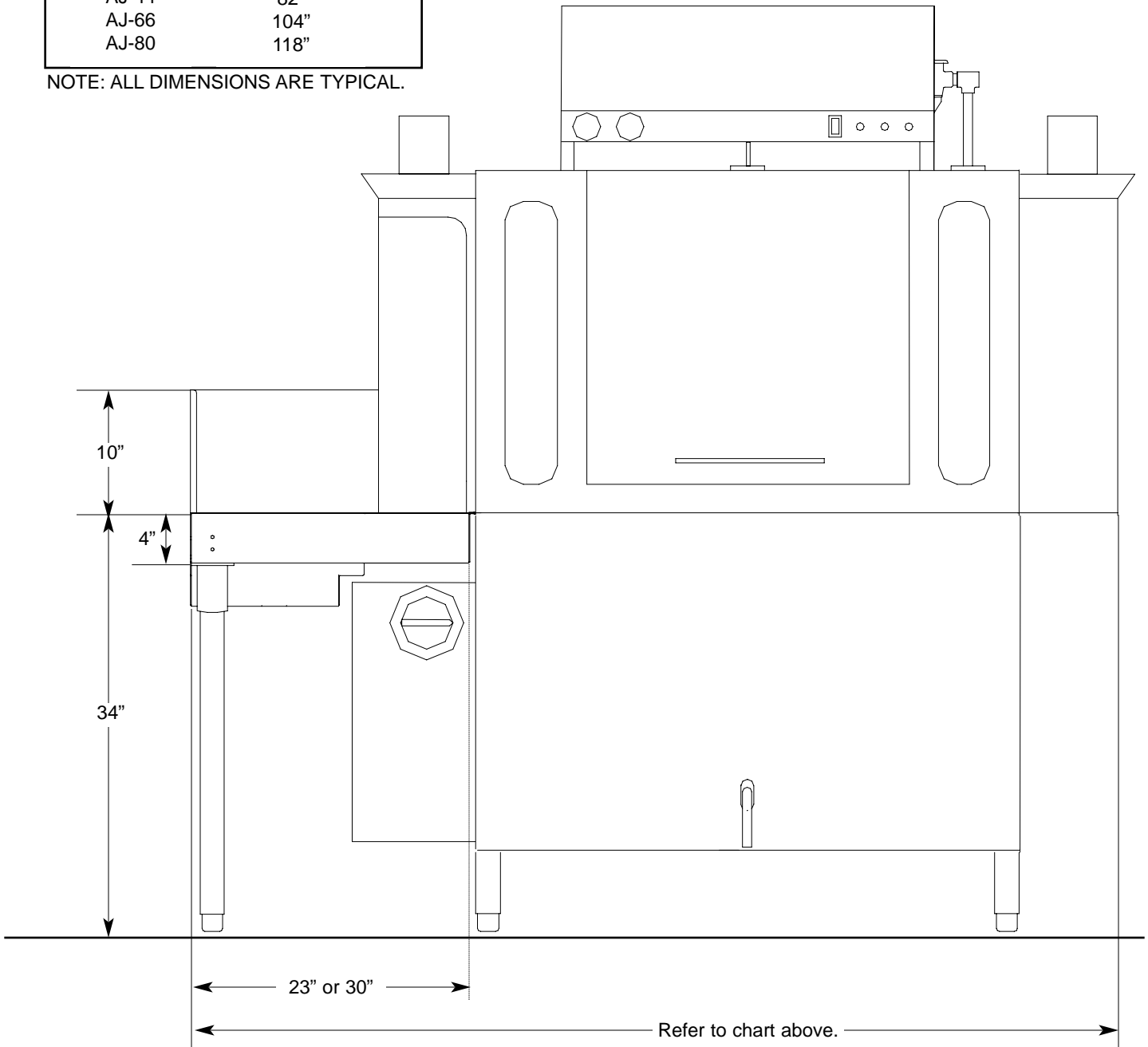

SECTION 1: SPECIFICATION INFORMATION

D226 STEAM BOOSTER DIMENSIONS

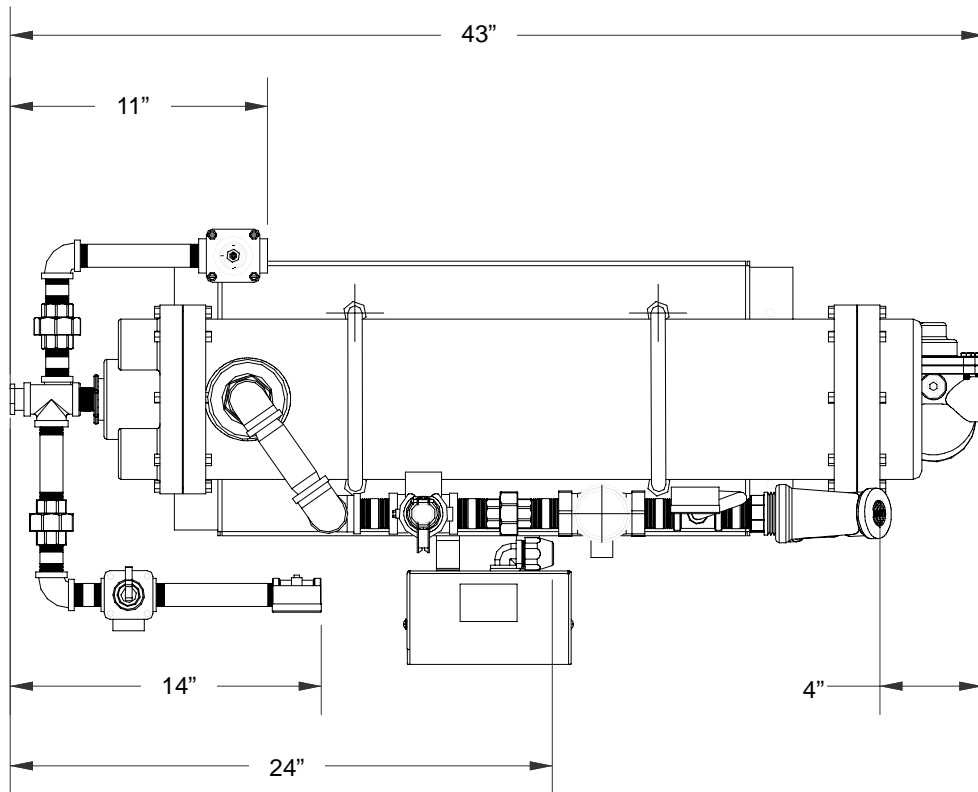

NOTE: All dimensions are in inches and are for reference only.

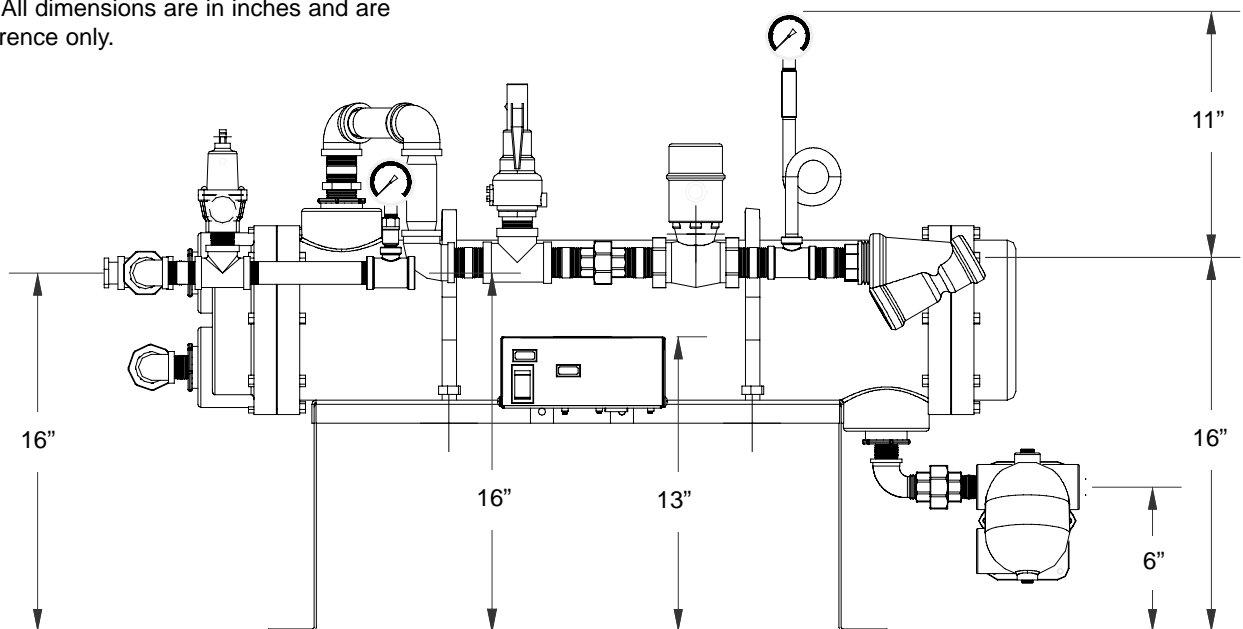

SECTION 1: SPECIFICATION INFORMATION

D226 STEAM BOOSTER PLUMBING LINE DRAWINGS

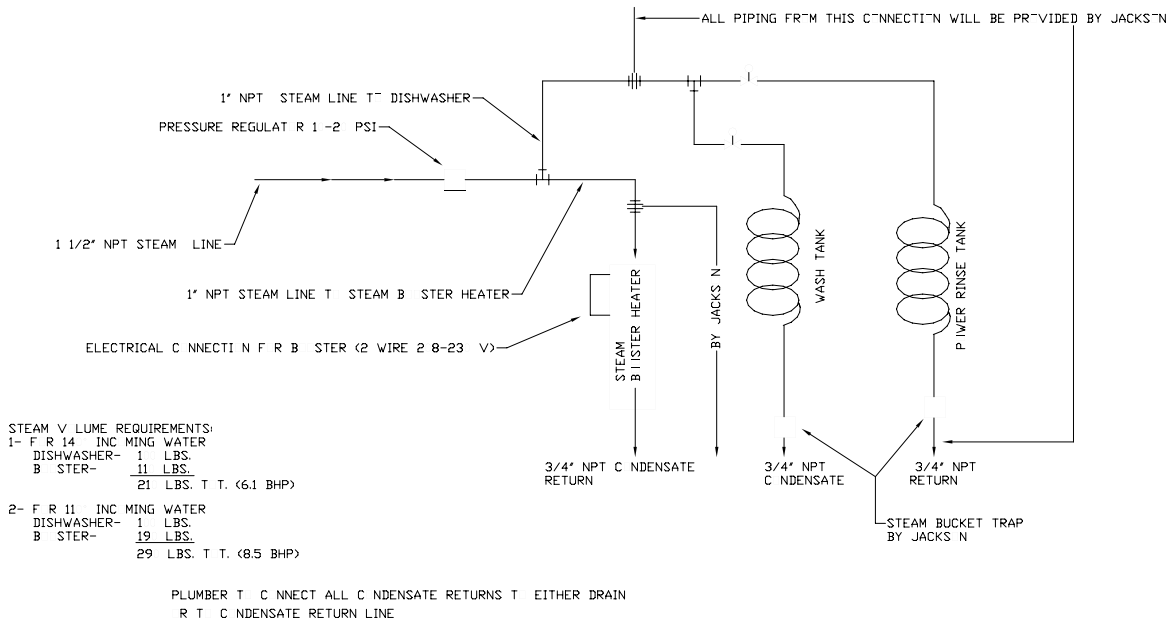
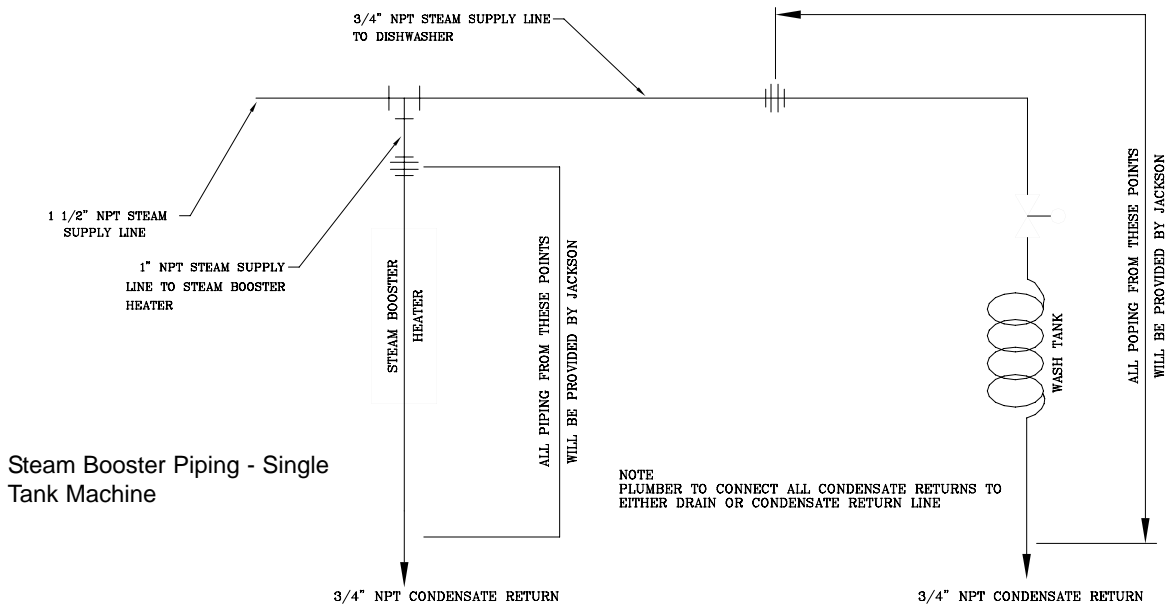

Steam Booster Piping - Double Tank Machine

SECTION 1: SPECIFICATION INFORMATION

TYPICAL ELECTRIC AND GAS BOOSTER DIMENSIONS

Electric Booster Dimensions (Typical)

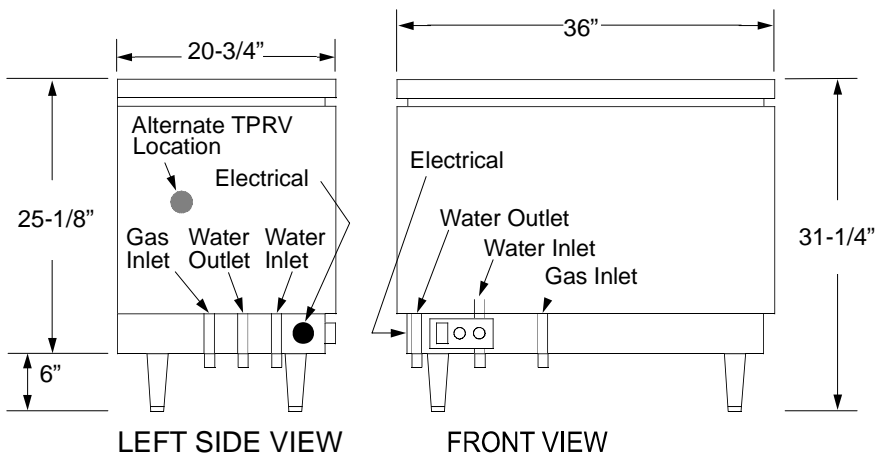
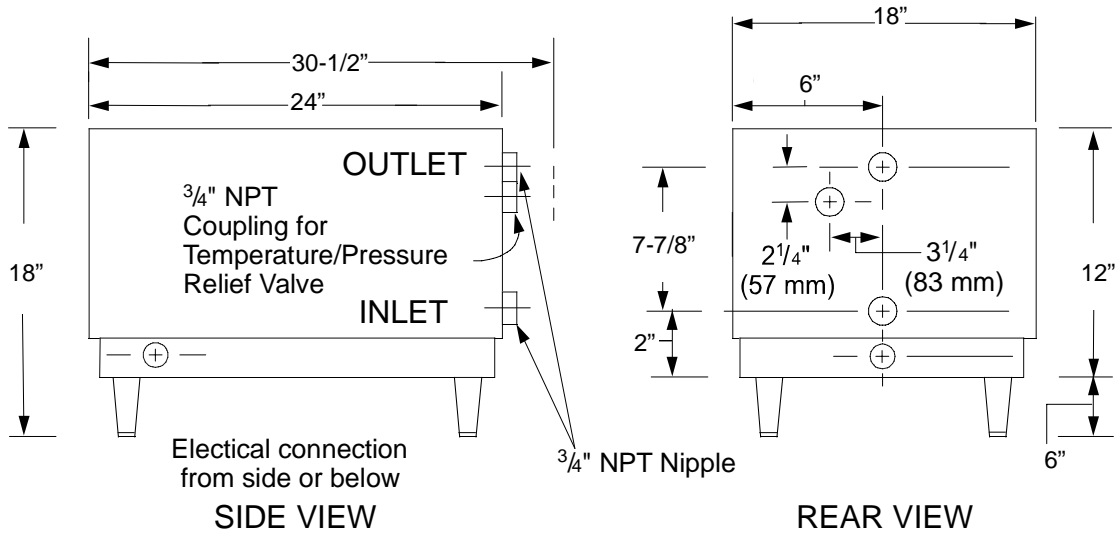

Gas Booster Dimensions (Typical)

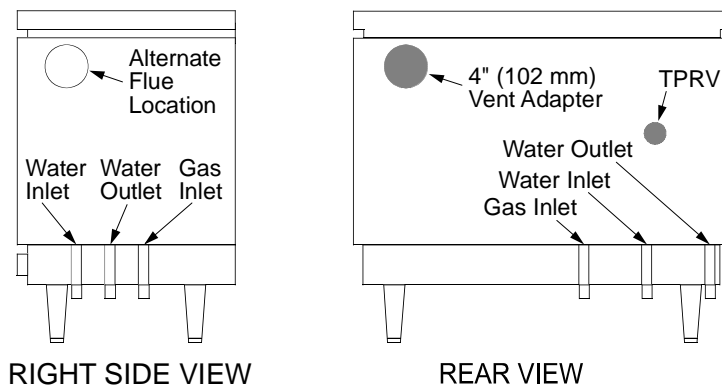

**SECTION 2:
INSTALLATION & OPERATION
INSTRUCTIONS**

SECTION 2: INSTALLATION/OPERATION INSTRUCTIONS

INSTALLATION INSTRUCTIONS

NOTE: THE INSTRUCTIONS PROVIDED HEREIN, UNLESS OTHERWISE SPECIFIED ARE FOR THE DISHMACHINES ONLY. THERE ARE SEPARATE DIRECTIONS FOR THE GAS BOOSTER.

VISUAL INSPECTION: Before installing the unit, check the container and machine for damage. A damaged container is an indicator that there may be some damage to the machine. If there is damage to both the container and machine, do not throw away the container. The dishmachine has been inspected and packed at the factory and is expected to arrive to you in new, undamaged condition. However, rough handling by carriers or others may result in damage to the unit while in transit. If such a situation occurs, do not return the unit to Jackson; instead, contact the carrier and ask them to send a representative to the site to inspect the damage to the unit and to complete an inspection report. You must contact the carrier within 48 hours of receiving the machine. Also, contact the dealer through which you purchased the unit.

UNPACKING THE DISHMACHINE: The machine should be unboxed and removed from shipping pallet prior to being installed. Open the front door and remove all of the packing materials. Once unpacked, ensure that there are no missing parts from the machine. This may not be obvious at first. If it is discovered that an item is missing, contact Jackson immediately.

LEVEL THE DISHMACHINE: The dishmachine is designed to operate while being level. This is important to prevent any damage to the machine during operation and to ensure the best results when washing ware. The unit comes with adjustable bullet feet, which can be turned using a pair of channel locks or by hand if the unit can be raised safely. Ensure that the unit is level from side to side and from front to back before making any connections. You will be able to adjust the overall height of the unit by turning the bullet feet from between 75-1/2" to 76-1/2".

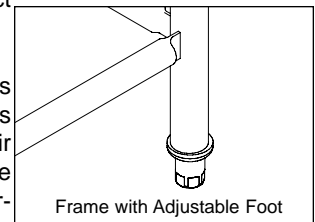

PLUMBING THE DISHMACHINE: All plumbing connections must comply with all applicable local, state, and national plumbing codes. The plumber is responsible for ensuring that the incoming water line is thoroughly flushed prior to connecting it to any component of the dishmachine. It is necessary to remove all foreign debris from the water line that may potentially get trapped in the valves or cause an obstruction. Any valves that are fouled as a result of foreign matter left in the water line, and any expenses resulting from this fouling, are not the responsibility of the manufacturer.

Water hardness should be a maximum of 6 grains per gallon. Harder water should be treated prior to using the machine. Iron in the water supply can cause staining. A filter designed to remove iron from the supply water is highly recommended for supplies in excess of 0.1 ppm (parts per million).

CONNECTING THE DRAIN LINE: The drain for the models covered in this manual are gravity discharge drains. All piping from the machine to the drain must be a minimum 1 1/2" NPT and should not be reduced. There must also be an air gap between the machine drain line and the floor sink or drain. If a grease trap is required by code, it should have a flow capacity of 30 gallons per minute.

WATER SUPPLY CONNECTION: Ensure that you have read the section entitled "PLUMBING THE DISHMACHINE" above before proceeding. The supply water temperature must meet the minimum requirements listed on the machine data plate. Install the water supply line (3/4" pipe size minimum) to the dishmachine line strainer. It is recommended that a water shut-off valve be installed in the water line between the main supply and the machine to allow access for service. The water supply line is to be capable of 25 PSI "flow" pressure at the recommended temperature indicated on the data plate.

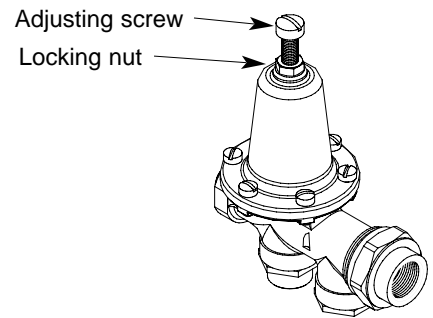

If the water level is too low or too high, check the incoming water pressure. It should be 20 ± 5 PSI. Too high of pressure results in too much water; too low of pressure results in too little water. To adjust the regulator, loosen the nut at the top, this will allow you to screw or unscrew the adjustment. With a screwdriver, turn the adjuster clockwise to increase pressure or counter clockwise to decrease it.

Do not confuse static pressure with flow pressure. Static pressure is the line pressure in a "no flow" condition (all valves and services are closed). Flow pressure is the pressure in the fill line when the fill valve is opened during the cycle.

SECTION 2: INSTALLATION/OPERATION INSTRUCTIONS

INSTALLATION INSTRUCTIONS (CONTINUED)

It is also recommended that a shock absorber (not supplied) be installed in the incoming water line. This prevents line hammer (hydraulic shock), induced by the solenoid valve as it operates, from causing damage to the equipment.

STEAM LINE CONNECTIONS: Some machines covered in this manual are designed to use low pressure steam as a source of heat for wash tank water. The machines come with lines by which outside source steam needs to be connected. Connect all incoming steam lines in accordance with the steam booster manufacturer's instructions. Ensure that all applicable codes and regulations are adhered to. See machine data plate for information concerning steam flow pressure.

GAS CONNECTIONS: Some machines covered in this manual are designed to use gas as an outside source of heat for wash tank water. The machines come with connections by which an outside source needs to be connected. Connect all incoming gas lines in accordance with the gas booster manufacturer's instructions. Ensure that all applicable codes and regulations are adhered to.

PLUMBING CHECK: Slowly turn on the water supply to the machine after the incoming fill line and the drain line have been installed. Check for any leaks and repair as required. All leaks must be repaired prior to placing the machine in operation.

ELECTRICAL POWER CONNECTION: Electrical and grounding connections must comply with the applicable portions of the National Electrical Code ANSI/NFPA 70 (latest edition) and/or other electrical codes.

Disconnect electrical power supply and place a tag at the disconnect switch to indicate that you are working on the circuit.

The dishmachine data plate is located on the right side and to the front of the machine. Refer to the data plate for machine operating requirements, machine voltage, total amperage load and serial number.

To install the incoming power lines, open the control box. Install conduit into the pre-punched holes in the back of the control box. Route power wires and connect to power block and grounding lug. Install the service wires (L1, L2, and L3 (3 phase only)) to the appropriate terminals as they are marked on the terminal block. Install the grounding wire into the lug provided. Tighten the connections. It is recommended that "DE-OX" or another similar anti-oxidation agent be used on all power connections.

VOLTAGE CHECK: Ensure that the power switch is in the OFF position and apply power to the dishmachine. Check the incoming power at the terminal block and ensure it corresponds to the voltage listed on the data plate. If not, contact a qualified service agency to examine the problem. Do not run the dishmachine if the voltage is too high or too low. Shut off the service breaker and mark it as being for the dishmachine. Advise all proper personnel of any problems and of the location of the service breaker. Replace the control box cover and tighten down the screws.

VENTILATION OF DISHMACHINE: The dishmachine should be located with provisions for venting into an adequate exhaust hood or ventilation system. This is essential to permit efficient removal of the condensation exhaust. Ensure that the exhaust system is acceptable in accordance with all applicable codes and standards.

NOTE: Any damage that is caused by steam or moisture due to improper ventilation is NOT covered under the warranty.

This units covered in this manual have the following exhaust requirements:

Load End:	200 CFM
Unload End:	400 CFM



Incoming Power Connection

SECTION 2: INSTALLATION/OPERATION INSTRUCTIONS

INSTALLATION INSTRUCTIONS (CONTINUED)

The exhaust system must be sized to handle this volume for the dishmachine to operate as it was designed to.

ELECTRIC HEAT: The thermostats for the machines covered in this manual are factory set. They should not be adjusted except by an authorized service agent.

CHEMICAL FEEDER EQUIPMENT: The AJ-44CEL/CSL, AJ-66CEL/CSL, and AJ-80CEL/CSL are designed to operate with a third party chemical injection system. Jackson does not endorse any particular chemical injection system. The system selected must be able to provide detergent and sanitizer in the required concentrations. The minimum chlorine concentration for proper sanitization is 50 PPM. Furthermore, the selected feeder needs to be able to operate against a head of 25 PSI and deliver 7.38 ml of a 10% chlorine sanitizer per minute.

Detergent may be introduced into the unit through the removal of the bulkhead plug in the rear of the tub and replacing it with the third party detergent injection fitting. Remove the bulkhead plug in the side of the tub to install the detergent concentration probe.

For more information concerning detergent concerns, please refer to the page entitled "Detergent Control".

Brass Plug

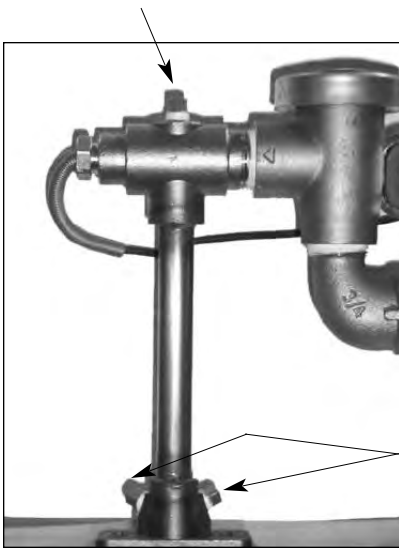

The 1/8" brass plugs on the incoming plumbing rinse injector may be removed to install sanitizer and rinse aid injection fittings.

Brass Plugs



Detergent Connection Point
(Machine rear view)

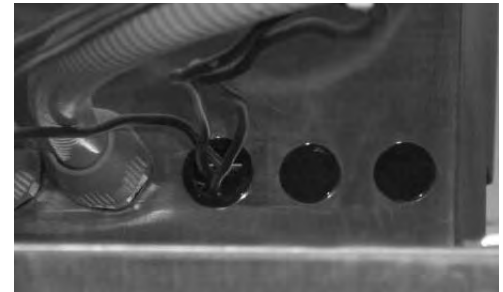

Back of Control Box

All wires for the chemical injectors should be routed through one of the extra openings in the back of the control box.

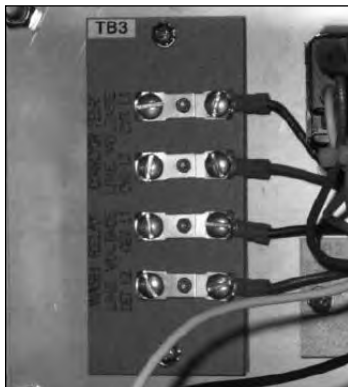

Aid Connection Points

Terminals in the control box marked "CVS" provide a constant voltage signal whenever the drive motor is operating.

Terminals in the control box marked "DET" provide a voltage signal whenever the wash motor is operating.

SECTION 2: INSTALLATION/OPERATION INSTRUCTIONS

DELIMING OPERATIONS

DELIMING OPERATIONS: In order to maintain the dishmachine at its optimum performance level, it will be required to remove lime and corrosion deposits on a frequent basis. A deliming solution should be available from your detergent supplier. Read and follow all instructions on the label of the deliming solution.

To proceed with the deliming operation, fill the dishmachine and add the correct amount of deliming solution as recommended by the deliming solution manufacturer. The water capacity of the various tanks of the dishmachine can be verified on the specification sheet(s) of this manual.

Perform the following operations to delime the dishmachine:

1. Turn the AUTOMATIC/DELIME switch on the back of the control box to the DELIME position.
2. Disconnect or turn off all chemical feeder pumps.
3. Close all doors (after adding the deliming solution).
4. Run the machine for the recommended period of time.
5. Turn the unit off and open the doors.
6. Wait five minutes, then inspect the inside of the machine. If the machine is not delimed, run another time cycle as per the deliming solution's instructions.
7. When clean, drain and re-fill the machine.
8. Run in MANUAL for 10 minutes to remove residual deliming solution.
9. Drain and re-fill the machine.



Delime Switch

This equipment is not recommend for use with deionized water or other aggressive fluids. Use of deionized water or other aggressive fluids will result in corrosion and failure of materials and components. Use of deionized water or other aggressive fluids will void the manufacturer's warranty.

SECTION 2: INSTALLATION/OPERATION INSTRUCTIONS

CHANGING THE AJ-44CE/CS DIRECTION OF TRAVEL

The AJ-44 dishmachine has the ability to have its direction of travel changed from left to right, or from right to left. Direction of travel is determined by which end the rack of ware is put into the machine and which end the rack comes out.

There may come times when it is necessary to change the direction of travel after the unit is installed. The instructions provided here are for maintenance personnel only. Unauthorized persons should not attempt any of the steps contained in these instructions.

Warning: many of the instructions and steps within this document require the use of tools and may also require that personnel change the wiring of the machine. Only authorized personnel should ever perform any maintenance evolution on the dishmachine!

PREPARATION

1. Power must be secured to the unit at the service breaker. Tag or lock out the service breaker to prevent accidental or unauthorized energizing of the machine.
2. Disconnect incoming water at the water pressure regulator or Y-strainer.
3. Disconnect the service drain line from the drain plumbing of the dishmachine itself. Ensure that the unit is completely drained before doing this.
4. Remove the locking screw from the control box.
5. Remove the front dress panel.

TOOLS REQUIRED

The following tools will be needed to perform this maintenance evolution:

1. 5/16" nutdriver
2. 7/16" nutdriver
3. 7/16" combination wrench
4. 7/16" socket with drive ratchet and 4" extension
5. 12" pipe wrench
6. 10" adjustable wrench
7. Wire cutters
8. Phillipshead screwdriver

TIME REQUIRED

It is estimated that it will take (1) person three hours to perform this task, not including all of the items indicated in the section entitled "PREPARATION".

IMPORTANT NOTES

1. Do not lose hardware! Place hardware in a safe spot away from the machine, ensuring that it does not fall loose into the machine tub. Hardware that is drawing into the suction of the wash pump will damage the equipment. If you do need more hardware, contact your JACKSON representative to purchase new items.

2. Read these instructions thoroughly before attempting this maintenance evolution. Become familiar with the parts and what actions need to be taken. This will save time in the long run!

STEPS

1. Remove the upper wash arm assembly by loosening the spin nut. The spin nut has a stop so it will not come off. Once it is loosened, the wash arm assembly should slide off.

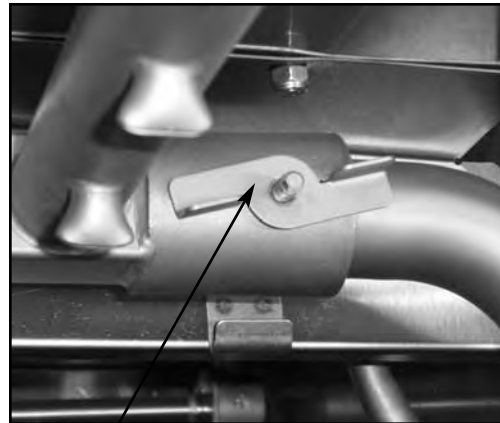

Spin nut

2. Remove the end cap from the wash arm assembly and place in the opposite end, securing it snugly.

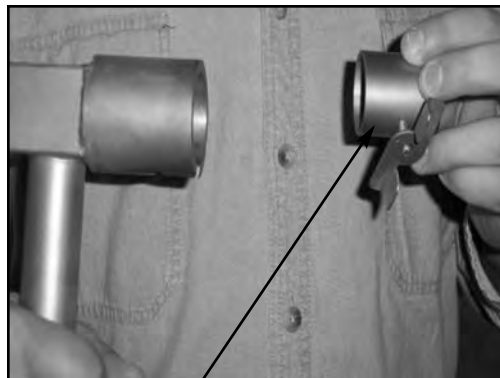

End cap

3. With the end cap securely in the opposite end of the wash arm assembly, set the assembly gently to the side. Go back inside the unit to where the upper wash arm assembly secured in the unit and turn the spin nut so that it is all the way down. This needs to be done because in a further step, if the spin nut is out, it will get in the way. Do not over-tighten the spin nut as it only needs to be out of the way, not secured.

SECTION 2: INSTALLATION/OPERATION INSTRUCTIONS

CHANGING THE AJ-44CE/CS DIRECTION OF TRAVEL (CONTINUED)

4. Remove the upper wash arm assembly bracket. This step may require that you have help as the bolts for securing the bracket to the top of the inner hood are the same bolts that hold the control box to the hood top. Do not remove the bolts once the nuts are taken off. Once the bracket is removed, place the nuts immediately back on the bolts. To hold the bolts (to keep them from spinning), a 7/16" combination wrench or 7/16" nutdriver will be required in order to hold the bolt head inside the control box.

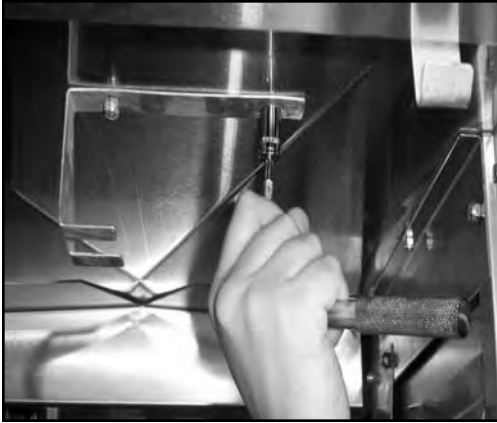

Removing bracket (bottom view)



Removing bracket (control box view)

Remove the locknuts from the opposite bolts used to hold down the control box (do not remove the bolts) and secure the bracket to underside of the hood. The folded part of the bracket should be facing the rear of the machine. Immediately tighten down the locknuts.

5. Remove the splash shield, which is bolted to the underside of the hood next to the wash manifold and turn it 180°.



Removing and turning splash shield

6. Remove the pawl bar and set to the side.



Remove the pawl bar by grasping firmly and lifting up.

7. Remove the lower wash arm assembly by turning the locking screw to unlatch it. The entire assembly should then lift out.



Locking screw

8. Remove the lower wash arm support bracket. Place it to the side with its locknuts.

SECTION 2: INSTALLATION/OPERATION INSTRUCTIONS

CHANGING THE AJ-44CE/CS DIRECTION OF TRAVEL (CONTINUED)



Removing the locknuts for the lower wash arm support bracket.

9. Remove the lower rinse arm support bracket, which is mounted directly opposite of the lower wash arm support bracket.



Removing the lower rinse arm support bracket

10. Remove the lower and upper rinse arms by unscrewing them and then gently pulling them out.



Unscrewing and removing the lower rinse arm

11. Behind the rinse manifold, remove the nut on the bracket.



Removing the bracket nut

12. Remove the nuts from the rinse manifold mounting bracket located on the underside of the hood. These nuts are mounted directly to the rinse injector weldment on the hood top.



Removing the locknuts from the rinse manifold mounting bracket

13. The rinse manifold must be removed. This may prove difficult while the rinse injector is still mounted. With great care, it is possible to gently lift the rinse injector off of the hood to allow the rinse manifold to be removed from the unit. Ensure that the gasket in the underside of the hood stays with the rinse manifold as it must be replaced when re-installing the manifold. If the gasket becomes lost or torn, order a new one immediately.



Lifting the rinse injector to make room

14. Remove the entire rinse tray assembly, including the pan

SECTION 2: INSTALLATION/OPERATION INSTRUCTIONS

CHANGING THE AJ-44CE/CS DIRECTION OF TRAVEL (CONTINUED)

and the strainer within in. The assembly should lift right out. (See next page for photograph detailing this step)

15. Remove the front and rear rinse pan locator brackets. **Note: the brackets are mounted to the bolts that secure the tub weldment to the frame.** Once the locknuts are removed, pull the locator brackets off and immediately replace the locknuts back onto the bolts. Failure to do so at a minimum may cause excessive leaking of the tub once the unit is placed back in operation.



Lifting out the rinse tray assembly



Removing a rinse tray guide bracket

16. On the drain plumbing, the rinse drain tube needs to be removed from the plumbing, as well as the wash drain tube. Both of these tubes are secured with hose clamps. Loosen the hose clamps and pull the tubes off.



Loosening the rinse drain hose from the rinse drain nipple

17. The tee that the rinse drain nipple is in must be turned 180° so that it is facing the opposite direction. This may require dis-

mantling the plumbing by removing the tee with the wash drain barb in it. Put the plumbing back together, after ensuring that the rinse drain tee has been rotated. Use thread tape to protect the threads while putting the plumbing back together. Ensure that the wash drain barb is in the exact same position it was prior to this step.

18. On the underside of the tub, remove the rinse drain weldment and the rinse drain plug. Switch their locations so that the rinse drain weldment is in the spot that the rinse drain plug was in.



Removing the rinse drain weldment

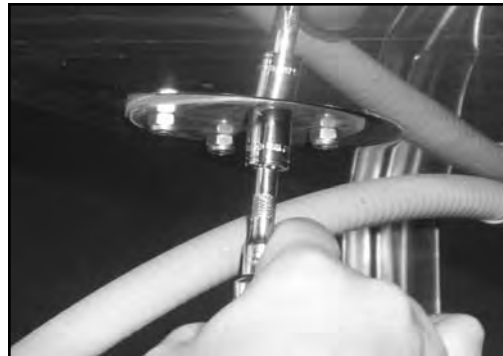

Removing the rinse drain plug

19. Reconnect the rinse drain hose and the wash drain hose to the drain plumbing.

20. On the opposite end from where they were removed, install the front and rear rinse pan assembly locating brackets. **Note: the brackets are mounted to the bolts that secure the tub weldment to the frame.** Install the brackets one at a time and ensure that they are firmly tightened down once installed.

21. Remove the hole cover weldment from the top of the hood. The cover is located on the end of the hood opposite of the rinse injector weldment. Once removed, set to the side along with its gasket.