



kitchen think

Instructions for Installation and Use

**Dishwasher
Model BFI62**

To the Installer

**Before installation fill in the product details on the back cover of this book.
The information can be found on the rating plate.**

To the User

**You must read the instructions prior to installing and using the appliance and
then retain them for future reference.**

Contents

Electrical Connection	3
For Your Safety	4
Installation	5
Getting to know your Dishwasher	6
The Controls	6
How to use your Dishwasher	7
Programme Chart	8
Before Using your Dishwasher	9-10
Loading your Dishwasher	11
Care and Cleaning	12
Troubleshooting	13
Information for Test Labs	14
After Sales Service	15
Hotpoint Guarantee	16
Key Contacts	Back Cover

Retention of this Instruction Book

This Instruction Book must be kept handy for reference as it contains important details on the safe and proper use of the appliance.

If you sell or pass the appliance to someone else, or move house and leave it behind, make sure this Book is also provided so the new owner can become familiar with the appliance and safety warnings.

If the Book is lost or damaged a copy may be obtained from:
GDA LTD., Morley Way, Peterborough, PE2 9JB

Electrical Connection

WARNING: This appliance must be earthed.

Fuses

Your appliance comes fitted with a plug and a 13A fuse. If you need to replace the fuse, only those rated at 13A and ASTA approved to BS1362 should be used. If you lose the fuse cover, a replacement may be obtained from your local authorised Service Centre or Electrical company. Correct replacement is identified by colour coding or the marking on base of plug.

WARNING: DO NOT use the plug unless the fuse cover is fitted.

Changing the Plug

Cut off and dispose of the supplied plug if it does not fit your socket.

WARNING: To avoid a shock hazard DO NOT insert the discarded plug into a socket anywhere else.

IMPORTANT: WIRES IN THE MAINS LEAD ARE COLOURED IN ACCORDANCE WITH THE FOLLOWING CODE:

Green/Yellow	-	Earth
Blue	-	Neutral
Brown	-	Live

If you change the plug, the colour of the wires in the mains lead may not correspond with the terminal markings in the plug, which if not coloured, could be:

EARTH	'E' or	
NEUTRAL	'N'	
LIVE	'L'	

Changing the Mains Lead

A lead can be ordered from Hotpoint Service

UK: 08709 066 066 or

Republic of Ireland: 1850 302 220

If you have damaged the existing lead or require a longer one a charge will be made. It is strongly advised that this work is carried out by a qualified electrician.

If the domestic wiring includes a residual current-operated circuit breaker, ensure that it conforms to the latest regulations.

Safety Information

At the time of delivery...

All functions of your dishwasher have been thoroughly tested at the factory. A small number of water marks may have been left as a result, they will disappear when the appliance is used for the first time.

WARNING: The dishwasher must not be connected to the electricity supply while installation is being carried out.

- This appliance should only be connected to a 230/240V AC source, via a properly installed earthed socket.
- Use the dishwasher solely in a domestic environment.
- DO NOT stand or place heavy objects on the door when it is open, this could damage the door or cause the appliance to tip forward.

If your family includes children...

- DO NOT allow children to play with the appliance or tamper with its controls.
- Keep detergents and rinse aids away from children. Keep children away from the open door of a dishwasher, there could still be some detergent left inside.

CAUTION:

The dishwasher meets the requirements set out by the regulations in force concerning safety and electrical equipment.

Any technical checks should be conducted exclusively by a trained and authorised technician: Repairs carried out by unauthorised persons will invalidate the guarantee, as well as posing a potential hazard to the user.

The manufacturer declines all responsibility for damage to persons or property resulting from failure to observe the above precautions, from tampering with even a single component or from the use of non-original spare parts.

For your Safety

This manual forms an integral part of the appliance. It must always be kept handy for reference. Read through all the instructions contained in this manual before using the dishwasher.

Installation must be performed by a qualified technician, in compliance with the regulations in force, including the prevention and elimination of radio frequency interference.

The dishwasher is designed for washing and drying dishes, any other use shall be considered improper. The manufacturer declines all responsibility for uses other than those described above.

1. Separate the various packaging materials and dispose of safely - DO NOT leave discarded packaging material around the home.
2. After removing the packaging, check to make sure your appliance is intact. If in doubt, contact a qualified professional.
3. DO NOT use extension leads and multiple plugs. If the electricity supply wire is not long enough, then have it replaced with one of the correct length and remember that it should be free of bends or dangerous kinks.
4. In the event of any damage to the power cord have it replaced by a qualified technician.
5. The mains plug must be easily accessible after installation.
6. If the appliance is not operating properly or if maintenance operations are necessary, disconnect the dishwasher from the mains power supply (unplug it!).
7. DO NOT install outdoors, not even if the area is covered by a roof: it is extremely dangerous to leave it exposed to rain and thunderstorms.
8. If installed on a carpeted or covered floor, ensure that the openings on the underside are not obstructed.
9. Do not touch the heating element during or straight after a wash cycle.
10. If the appliance malfunctions, turn off the water inlet tap and disconnect the plug from the wall socket. Then read the section entitled "Troubleshooting". If you cannot resolve the problem, then call Hotpoint Service (see KEY CONTACTS, back page).

***The rating plate, featuring the technical data, serial number and markings, is visibly positioned on the inner edge of the door.
DO NOT remove the rating plate.***

The dishwasher is intended for use by adults. DO NOT allow children to come near or play with the controls.

Keep children away from detergents and clear of the dishwasher door when open.

Keep all packaging material away from children.

1. DO NOT use solvents, such as alcohol or turpentine which may cause an explosion.
2. DO NOT load dishes to wash that are soiled with ash, wax or paints.
3. DO NOT lean, sit or stand on any part of the dishwasher - this could cause injury and/or damage the appliance.
4. DO NOT drink any water residues from inside the dishwasher.

Installation

Choose where you want to install your dishwasher, you can place it so that its sides or back panel are side by side with furniture or up against the wall. The dishwasher is provided with water supply and drain hoses, which can be directed towards the left or right to facilitate appropriate installation.

Levelling.

Once the appliance is positioned, adjust the feet by screwing them in or out depending on how high you want it and to level it so that it is horizontal. Make sure that it is not inclined more than 2 degrees. If the appliance is level, it will help ensure its correct operation.

Height Adjustment

Insert the appliance into the cutout and then adjust the height using the screws located on the front bottom part of the machine. Use a screwdriver to turn the screws in the clockwise or anti-clockwise direction to increase or decrease the height respectively.

Cold water connection.

Connect the cold water supply hose, inserting the small filter supplied with the dishwasher and making sure that it is fastened tightly in place (see figure 2). If the water hoses are new or have been out of use for an extended period of time, let the water run to make sure it is clear and free of impurities before making the connection. If this precaution is not taken, the water inlet could get blocked, causing damage to your dishwasher.

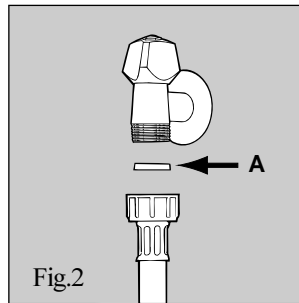

Drain hose connection.

WARNING: Connect your dishwasher drain hose to pipes which connect to the foul drain system and not to surface water drains.

IMPORTANT: For the correct operation of your dishwasher, it is essential to comply with the following information:-

Standpipe:

Ensure that the hose is not pushed too far down the standpipe.

If the end of your drain hose is fitted with 'retaining flaps', ensure they are inserted fully into the standpipe. This will prevent the pipe from jumping out during installation and use.

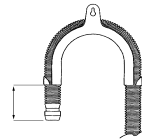

DO NOT position the standpipe near an electrical outlet.

ENSURE that the drain hose is not kinked and it is routed as shown in the diagram.

The standpipe should have a bore of at least 38mm (1 1/2"). It should be installed as shown, have a trap fitted and must discharge into the same drain system as your household sink.

It **MUST NOT** be connected to a surface water drain.

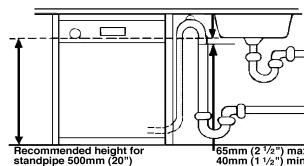

Sink Waste System:

For under sink drainage:

Before connecting the drain hose, remove any internal restrictions - This will prevent a build up of debris which could cause a blockage.

Remove any restrictions from the waste spigot and ensure that the sealing bung is removed. The hose should be routed, such that it is raised to a minimum height of 800mm (31 1/2").

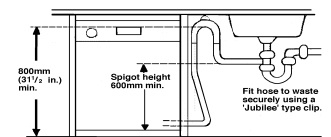

NOTE: Ensure the sink outlet pipe has a minimum diameter of 32mm.



1. Untie the end of the GREY drainage hose from the rear of the appliance.
2. Reposition the 'Hooked End Support' as required along the GREY drainage hose.
3. If fitting an under sink waste disposal unit, cut out the membrane, bung or blanking plug.
4. Attach the GREY drainage hose to the under sink waste disposal unit securely, using the clip and rubber tube supplied.



Ensure the drain hose is securely attached, to prevent it coming away while the machine is in use and causing a flood.

Getting to know your Dishwasher

- E. Upper basket
- F. Top spray arm
- G. Basket height adjuster
- H. Lower basket
- I. Bottom spray arm
- J. Salt container cap
- K. Washing filter
- L. Detergent and rinse aid dispenser

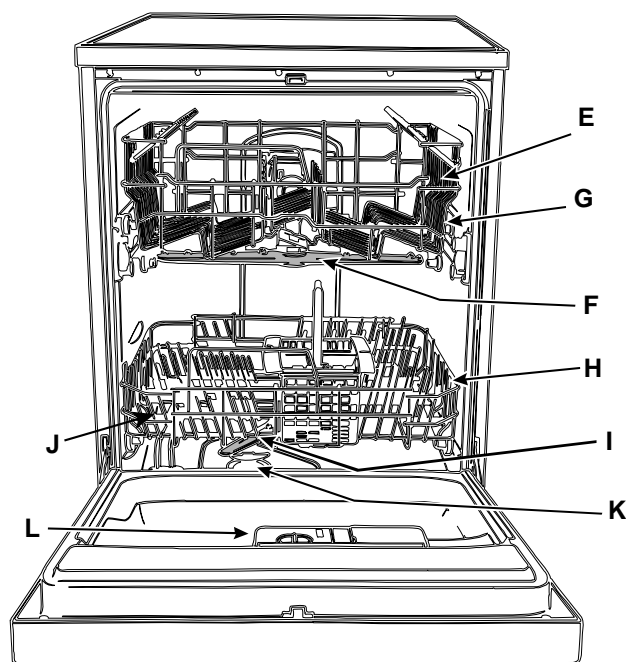

The Controls

- A. ON-OFF Button**
Press this button to switch the appliance on.
- B. ON-OFF Indicator light**
This light informs you that the dishwasher is on.
- P. Wash Programme Selector**
Each time this button is pressed, one of the cycle indicator lights "M" will come on in sequence.
- M. Cycle indicator light**
This light shows you which cycle you have selected or the one in progress.

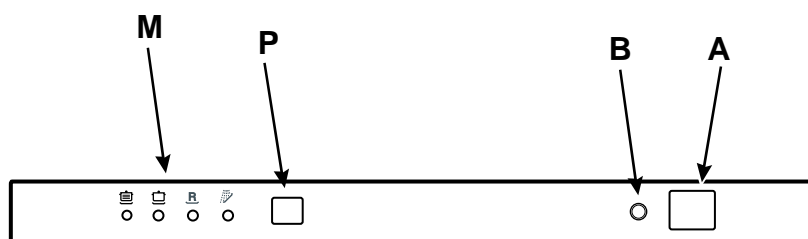

Technical Characteristics

Technical characteristics		This dishwasher conforms to the following European Community Directives:
Width	cm. 59,5	
Depth	cm. 57	
Height	cm. 82	
Capacity	12 standard place settings	
Mains water pressure	20 KPa ÷ 1MPa (0,2 ÷ 10 bar)	
Power voltage	See data plate	
Total absorber power	See data plate	
Fuse	See data plate	

How to use your Dishwasher

First of all.

- Turn on the water supply tap completely.
- Add the correct amount of detergent.
- Load the baskets correctly.
- Check that the spray arms rotate freely.
- Close the door securely.

- Press the ON-OFF button "A": indicator light "B" comes on. Your appliance is now on and awaiting instructions.

Select the wash cycle.

Select the wash cycle by pressing button "P". Each time this button is pressed, one of the indicator lights "M" will come on in sequence. Select the wash cycle most suitable for the type of dishes to wash (see 'Programme Chart').

Close the door and after a few seconds, you will hear a short beep: the wash cycle has started.

Modifying a wash cycle in progress.

If you have chosen the wrong cycle - You can modify the wash cycle in progress, if it has only just started. Open the door carefully, to avoid any hot water splashes. Then keep button "P" pressed in for approximately 5 seconds, until you hear 3 short beeps.

Indicator light "M" will go out to show all the settings will have been cancelled. You are now free to re-set the correct wash cycle.

You've left out a dish?

Interrupt the wash cycle by opening the door, carefully, then insert the dish you had forgotten.

When you shut the door the cycle will start up from where you interrupted it.

Cycle end

The end of the wash cycle is indicated by 2 short beeps and the flashing of the wash cycle indicator light "M".

Open the dishwasher door.

Turn the appliance off by pressing the ON-OFF button "A", thus switching off the electricity supply.

Turn off the water tap.

Wait a few minutes before unloading the dishes: they are very hot! If you wait a little while, they dry better due to the steam.





Empty the lower basket first.

There's been a power failure or you opened the dishwasher door

The wash cycle stops and then restarts when the electricity comes back on or when you close the door.

Programme Chart

Select the most suitable programme for the type of dishes and how dirty they are. To select the wash programme see the chart below:

Programme	When Programme should be used	Programme Description	Amount of detergent for pre-wash + wash	Rinse Aid
 Heavy Duty	Very dirty dishes and pans (not to be used for delicate items).	Pre-wash with cold water Pre-wash with hot water at 45°C. Extended wash at 70°C. Rinse with cold water. Rinse with hot water at 70°C. Drying.	5+25 gr.	*
 Daily cycle	Normally dirty pans and dishes. Standard daily cycle.	2 pre-washes with cold water. Extended wash at 50°C. Rinse with hot water at 70°C. Drying.	5+25 gr	*
 Rapid	Economy and fast cycle to be used for slightly dirty dishes. Run cycle immediately after use. No drying.	Short wash at 45°C. Cold rinse	25 gr.	
 Soak	Preliminary wash cycle for dishes and pans awaiting completion of the load with the dishes from the next meal.	Short cold wash to prevent food from drying onto the dishes.		

To optimise wash performance and save on energy, try to use the dishwasher with a full wash load. If it takes some time to fill your dishwasher, use the soak cycle to avoid caked on food and build up of bad odours.

Before Using your Dishwasher

Adjusting the water softener.

Your dishwasher can adjust its salt consumption according to the hardness of the water in your home. This way, you can optimise and customise your dishwasher's salt consumption.

To adjust salt consumption, do as follows:

1. Unscrew the salt container cap
2. There is an arrow on the neck of the container (see figure): if necessary, turn the arrow anti-clockwise from the "-" setting to the "+" setting.

Select the arrow position depending on the water hardness, referring to the table.

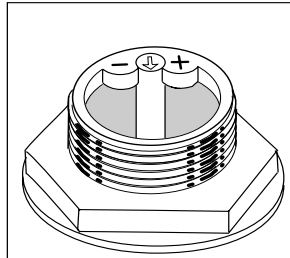

Water Hardness					
Clarke degrees	°fH	mmol/l	Selector position	Salt consumption (grams/-cycle)	Autonomy (cycles/2-kg)
0 - 14	0 - 17	0 - 1,7	/	0	/
14 - 36	18 - 44	1,8 - 4,4	"-"	20	60
36 - 71	45 - 89	4,5 - 8,9	MED	40	40
>71	> 89	> 8,9	"+"	60	25

You don't know how hard the water in your home is? Ask the company that supplies water in your area.

Salt

Filling the salt container.

Always use salt which is intended for dishwasher use.

The salt container is situated underneath the lower basket, fill it up as follows:

1. Pull out the lower basket completely, unscrew and remove the container cap
2. If it is the first time you add the salt, first fill the container up with water (you won't have to do this again next time)
3. Put the dishwasher funnel on the hole and pour in approximately two kilos of salt. It is normal that some water comes out of the container.
4. Screw the cap back in place carefully.

Low Salt indicator

This green device is located at the centre of the cap for the decalcification cartridge and it indicates whether the container is full.

When the indicator is not visible it means that you need to add salt.



Before Using your Dishwasher

The detergent

Adding detergent

To open lid A, press button B. The detergent should be put into the two containers C and D. If using a tablet, put it in container "D". Now you can close the lid: press it down until you hear it click.

If it won't close

Check whether there is any detergent residue on the edges of the dispenser. Remove the excess.

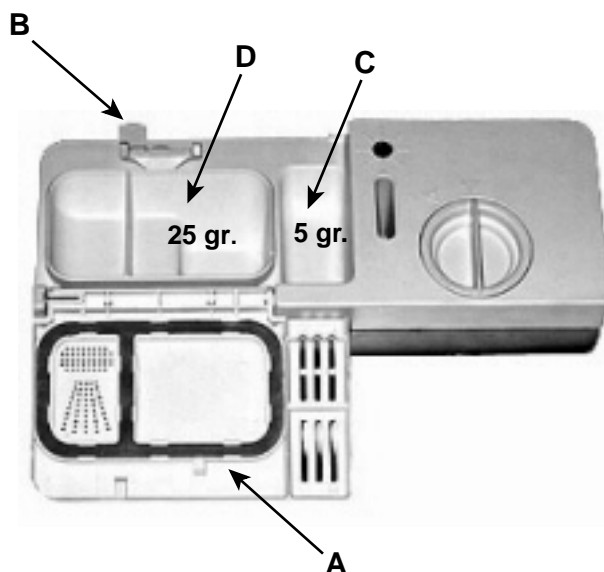

- Use the right amount of detergent (see programme chart).
- Store your detergent and rinse aid in a cool, dry place, safely away from children.

We recommend Glist 3 in 1 for use in all Hotpoint dishwashers...

Brilliant cleaning is guaranteed with **Glist 3 in 1**.

Hotpoint only recommends Glist 3 in 1 Dishwasher tablets to give outstanding cleaning and care.

It is important to use detergent specially designed for domestic dishwashers. (Always follow the manufacturers instructions.)

Glist 3 in 1 advanced dishwasher tablets with active enzymes are the ideal way to protect and care for your dishwasher, while getting your dishes and glasses sparkling clean.



*If you live in an area particularly prone to very hard water (>35°f) Glist and Hotpoint recommend that you continue to keep your dishwasher salt topped up.

Softer Water:

Built in salt action softens water, helping to prevent the build up of limescale in the dishwasher and improve the cleaning result*.

Cleaner Dishes:

With unique active enzymes in the cleaning phase **Glist 3 in 1** breaks down even the hard to shift foodstuffs and grease, leaving the dishes spotless and the dishwasher clean too.

Sparkling Results:

The built-in Glist rinse agent ensures the dishes and glasses are free from water marks and smears.

If you have any questions regarding **Glist 3 in 1**, please contact the hotline on 0800 216 730.

Rinse aid.

Rinse aid makes dishes sparkle more as it improves their drying. The rinse aid container is situated on the inside of the appliance door, you should refill it when light "D" indicates that it is empty.

(If your dishwasher is fitted with a "low rinse aid" indicator light, fill the container up when the indicator light flashes or lights up).

Adding rinse aid.

To open the dispenser, turn cap C anticlockwise. Take care when you pour in the rinse aid to avoid it overflowing. You can regulate the amount of rinse aid used by the dishwasher, move the adjuster F which you will find under lid C.

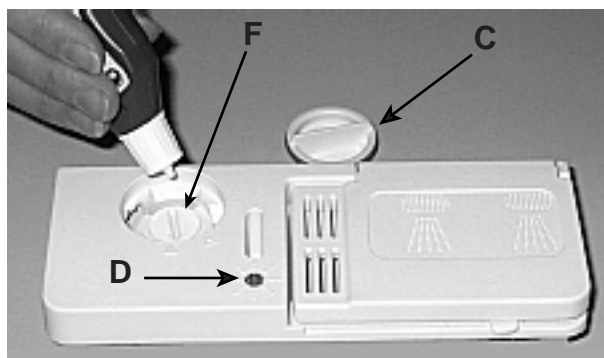

You can choose from six different positions.

It is normally set to 4.

- The amount of rinse aid needs to be increased if the dishes appear dull or you can see circular stains.
- The amount of rinse aid needs to be reduced if the dishes are sticky or you can see white streaks.

Loading your Dishwasher

First of all.

Before placing dishes in the baskets, remove all course food remains. This avoids blocking the filter, which would reduce the efficiency of the wash.

If saucepans and frying pans are very dirty, allow them to soak before being washed.

To make it easier to load your dishes, pull the baskets out.

What goes into the lower basket?

We recommend you place the most difficult dishes to wash into the lower basket: saucepans, lids, soup dishes and plates (a load example is shown in the photo).

- **Serving dishes and large lids:** place them on the sides of the basket.
- **Saucepans, salad bowls:** must always be placed upside down
- **Very deep dishes:** place them obliquely, thus allowing water to run down them and cleaning them better

Place the cutlery with the handles at the bottom; if the basket is the one with side inserts, then insert the tea spoons one by one into the slots. It is best if you place longer utensils horizontally at the front of the upper basket.



After loading the dishes, remember to check that the spray arms can turn freely without hitting against any dishes.

What goes into the upper basket?

Place delicate and lightweight dishes in the upper basket: glasses, tea cups and coffee cups, saucers and plates - shallow salad bowls, slightly dirty frying pans and shallow pans. Position lightweight dishes in such a way as to avoid their being moved by the spray of water.

How to adjust the upper basket.

The upper basket can be set in high or low position to enable you to organise your dishes effortlessly.

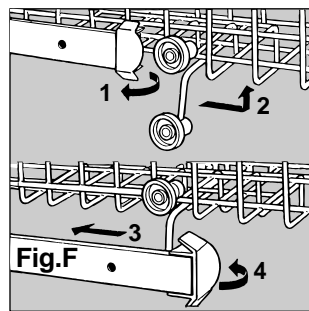

Open the rail stop flaps and pull the basket out completely. Now place it in high or low position, then slide it along the guide rails until the front wheels also go in. Now close the rail stop flaps. Follow the sequence of actions illustrated in figure "F".

What can I Wash *Items not suitable for the dishwasher:*

- Cutlery and tableware made from wood or part wood - They may become faded and unsightly in appearance.
- Avoid washing horn handled and bronze cutlery in the machine.
- Delicate/decorative glassware and vases, special antique or irreplaceable china - the decorative patterns printed on these items will not be dishwasher proof.
- Plastic objects that are not resistant to hot water.
- Copper and Pewter utensils. Aluminium and Silver objects.
- Some types of glass can become opaque in appearance after they have been washed too many times in a dishwasher.
- Highly absorbent materials such as sponges and towels should never be placed in a dishwasher.
- **If in any doubt, check with the manufacturer on items suitability for dishwasher's.**

WARNING: Dishes or cutlery soiled with tobacco ash, wax, lubricating grease or paint should not be put in the dishwasher.

Our recommendation: In future, only purchase table or kitchenware that has been confirmed - dishwasher proof.

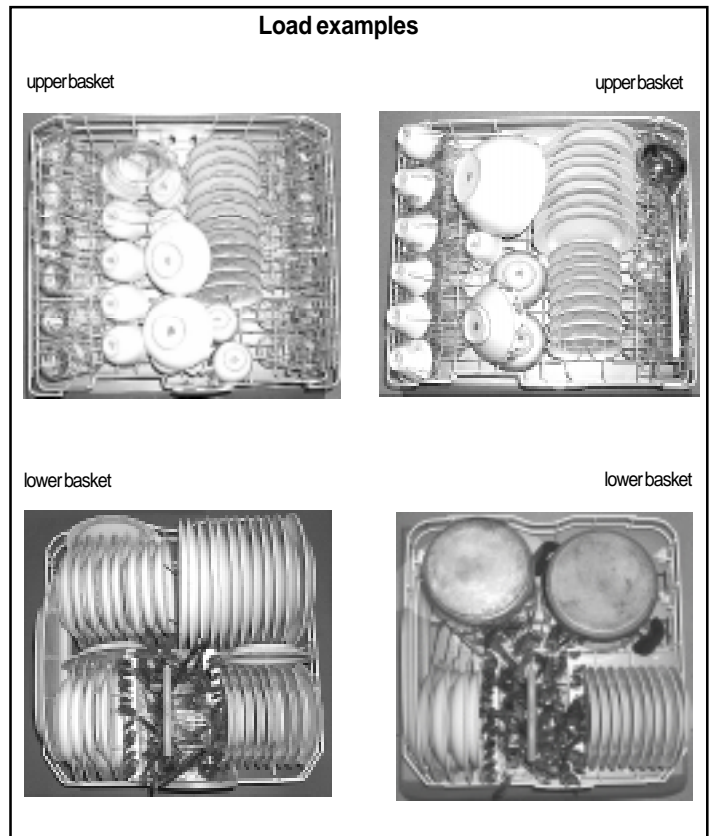

Care and Cleaning

Unplug the appliance.

Before carrying out any cleaning or maintenance on the dishwasher, always remove the plug from the electricity socket.

After every wash.

When the wash cycle has ended, always remember to turn off the water supply tap and to leave the appliance door ajar. This way, moisture and bad odours will not be trapped inside.

The filter assembly

- If you want consistent good results from your dishwasher, you need to clean the filter assembly.
- Remove the larger food particles trapped inside the cup "C" and the semi-circular filter A after each wash; pull the cup handle upwards to remove them. Just rinse them under running water.
- The entire filter assembly should be cleaned thoroughly once a month: cup C + semi-circular filter A + cylindrical filter B. Rotate filter "B" anticlockwise to remove it. For cleaning, use a non metallic brush.

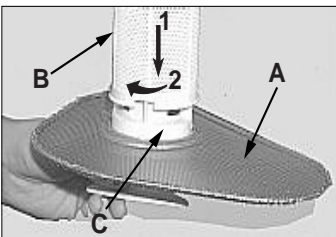

Reassemble the filter parts (as shown in the figure) and reinsert the whole assembly into the dishwasher. Position it into its housing and press downwards. The dishwasher is not to be used without filters. Improper replacement of the filters may reduce the efficiency of the wash and even damage your dishwasher.

Cleaning the spray arms.

Food residue may become encrusted onto the spray arms and block the holes where water comes out. Check the spray arms regularly and clean them once in a while.



Cleaning the Water Inlet Filter

Periodically clean the water inlet filter (see figure 2 under "Installation") located on the outlet of the water supply tap. After turning off the water tap, unscrew the end of the water supply hose, remove the filter and clean it carefully under running water. Then, return the filter to its place and tighten the water supply hose back into position.

The seals.

One of the factors that cause unpleasant odours to form inside the dishwasher is food that remains trapped in the seals. Periodic cleaning using a damp sponge will prevent this from occurring.

DONOT use solvents or abrasives to clean the exterior and rubber parts of your appliance, do not use solvents or abrasive cleaning products. Use a cloth dampened with lukewarm soapy water only. If there are any stains on the surface of the appliance interior, use a cloth dampened with water and a little white vinegar, or a cleaning product specifically made for dishwashers.

Going away

If the dishwasher is not going to be used for some time, carry out the following:

- run a cycle with the dishwasher empty.
- switch off at the electrical socket and unplug.
- turn off the water supply tap, disconnect the inlet hose and allow to drain.
- fill the rinse aid dispenser.
- leave the door ajar, to prevent the build up of unpleasant odours inside the dishwasher.

Before using the dishwasher after a long break, plug in and switch on at the electrical socket. Reconnect the inlet hose and turn on the water supply tap. Check there are no deposits of rust inside the water pipe, if there are allow water to run from the supply tap for a few minutes.

Disconnecting the dishwasher.

When disconnecting the dishwasher it is important that tasks are carried out in the correct sequence.

- switch off at the mains and remove the plug from the socket.
- turn off the water supply.
- disconnect drain and water inlet hose.
- pull out the dishwasher, carefully, withdrawing hoses at the same time.

Moving the appliance.

Drain water from the dishwasher. Secure all loose parts. Only transport in an upright position.

- If not kept upright during transport, any water remaining inside may seep into the control module and cause subsequent errors with programme functions.

Troubleshooting

Caution

- Do not forget that repairs should only be carried out by a qualified specialist. Improper repairs can lead to considerable equipment damage, as well as danger to the user.
- The dishwasher must first be disconnected from the electricity supply before any repairs or other work can be carried out. Switch off at the mains socket and water supply and remove the plug.

Resolving minor problems yourself.

Experience has shown that you can resolve most problems that arise during normal daily usage yourself, without having to call out a service engineer. Not only does this save costs but it also means the appliance is available for use again that much sooner. The following list of common occurrences and their remedies should help you identify the causes of most problems.

If the dishwasher won't start, check...

- Is the dishwasher plugged in at the electricity socket and switched on?
- Is there a power failure, check other appliances.
- Check the fuse.
- Is the water supply tap turned on?
- Is the water inlet hose connected properly?
- Is the pressure of the water supply sufficient?
- Is the inlet hose kinked?
- Is the filter on the water supply hose blocked?
- Is the dishwasher door not closed properly?

If water remains inside the dishwasher, check...

- the drain hose is not kinked.
- the drain syphon is not obstructed.
- the dishwasher filters are not clogged.

If the dishes are not being cleaned properly, check...

- the correct amount of detergent has been added.
- there is regenerating salt in the salt container.
- the dishes have been loaded correctly.
- the selected programme is suitable for the type of dishes and the degree of soiling.
- all filters are clean and positioned correctly.
- the spray arm nozzles are not obstructed.
- there is nothing obstructing the rotation of the spray arms.

If the dishes fail to dry or remain dirty, check...

- there is rinse aid inside the rinse aid container.
- the rinse aid dispenser setting is correct.
- the detergent being used is of good quality and has not lost its effectiveness (for example, through incorrect storage, with the box left open).

If the dishes show signs of streaking, staining etc. check...

- the rinse aid dispenser setting is not set too high.

If there are visible traces of rust inside the tank, check...

- the cap off the salt container is securely closed and that the water softener setting is correct.
- the correct amount of detergent is being used. Certain detergents can be more corrosive than others.
- the tank is made of steel and therefore any rust marks are due to external elements (fragments of rust from the tank pipes, pots, cutlery etc.) Special products are commercially available to remove such marks.

Error messages

Your dishwasher is equipped with a safety system which is able to detect operating faults.

These faults are reported by one or two cycle indicator lights "M" flashing rapidly. Take a note of which lights are flashing, turn the appliance off and call Hotpoint Service for technical assistance.

Tap off alarm

If you have forgotten to turn the water tap on, your appliance will remind you of this by sounding a few short beeps for a few minutes. Turn the tap on and your appliance will start up again after a few minutes. Were you to be absent when these beeps are sounded, the appliance will be blocked automatically and cycle 2 and 3 indicator lights (daily and rapid cycle) will flash rapidly. Turn the appliance off at the ON-OFF button, turn on the water tap and wait approximately 20 seconds before turning the appliance back on. Re-select the wash cycle and the appliance will start up again.

If after all the checks, the appliance still does not operate or the problem persists, call Hotpoint Service (see KEY CONTACTS, back page) and inform them of:

- the type of problem
- the abbreviation of the model name (Mod.) and the relative numbers (S/N) written on the rating plate located on the inner edge of the door.

Switch off at the mains socket and remove the plug. Turn off the water supply.

INFORMATION FOR TEST LABS

Load for 12 Standard Settings tests (upper rack at top position)

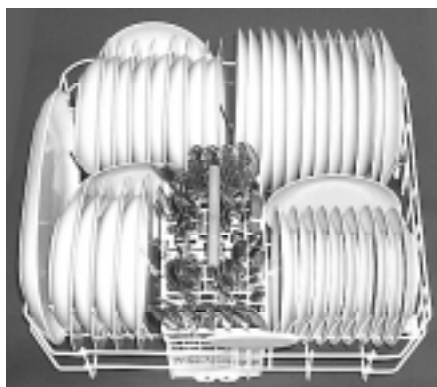

Detergent

Detergent specifically intended for use with dishwashers must be used. The dispenser must be refilled before the start of each wash cycle following the instructions provided in the "Programme Chart". The detergent dispenser is located on the inside panel of the door.

Loading the detergent

To open lid "A", press button "B". The cleaning detergent should be introduced into the three containers "1", "2" and "3". **"(see table at the end of the page)"**

After pouring in the detergent, replace the lid, pressing down until it clicks.

The rinse aid

This product makes dishes sparkle more as it improves their drying. The rinse aid container is situated on the inside of the door, you should refill it when light "D" indicates that it is empty.

(If your dishwasher is fitted with a "low rinse aid" indicator light, fill the container up when the indicator light flashes or lights up).

Loading the Rinse Aid

To open the dispenser, turn the "C" cap in the anti-clockwise direction and then pour in the rinse aid, making sure not to overfill. The amount of rinse aid used for each cycle can be regulated by turning the dose adjuster 'F' which you will find under lid 'C'.

There are 6 different settings; the normal dosage is setting 5

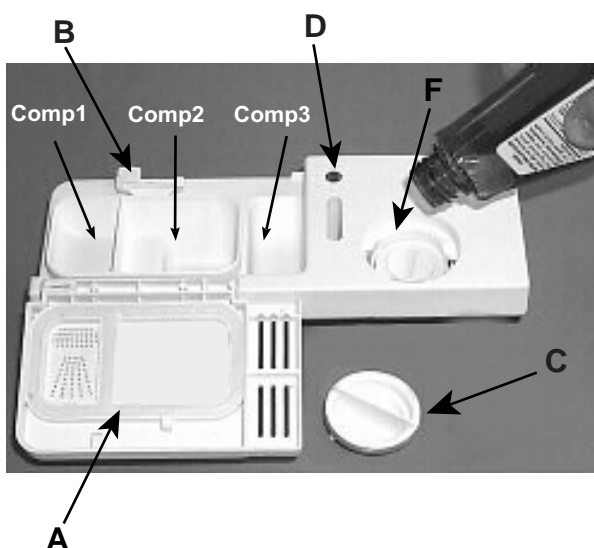

	Cycle	Total detergent	Comp.1	Comp.2	Comp.3
EN 50242	See booklet	30 gr.		25	5
IEC/ DIN	See booklet	30 gr.	10	20	

To use the Normal or daily wash cycles (See Programm Chart in the instruction booklet)



After Sales Service

"No company is better positioned to offer an after sales service on a Hotpoint appliance than us - the manufacturer"

As part of our commitment to you, all Hotpoint appliances have the added benefit of a fully inclusive parts and labour guarantee for the first 12 months. In addition to this you also have the advantage of

free

replacement parts for the first 5 years when fitted by a Hotpoint engineer. When the 12 months parts and labour guarantee expires we offer the following after sales service options:

Repair Service and Information Help Desk

UK: 08709 066066

www.theservicecentre.co.uk

Republic of Ireland: 1850 302 200

Note: Our operators will require the Model number and the Serial number of your appliance

Available 364 days a year with a fast, effective and value for money service. We have the largest white goods repair service in the UK with over 1200 of our own fully trained engineers. All repairs include a parts and labour guarantee for 12 months from the date of the repair.

If you require any information or have any questions about your appliance, our operators are on hand with help and advice.

All this ensures that you will receive the best available after sales service possible.

Extended Warranties

UK: 08709 088 088

www.theservicecentre.co.uk

Republic of Ireland: 1850 502 200

Whether you have just one or a number of Hotpoint appliances in your kitchen, we offer two service cover plans to give you total peace of mind.

- Repair Protection Plan - FREE service repairs for a single Hotpoint appliance during the period of cover.
- Kitchen Cover - FREE service repairs for all your Hotpoint appliances less than 8 years old.

Genuine Parts and Accessories UK: 08709 077 077

www.theservicecentre.co.uk

Republic of Ireland: (01) 842 6836

A wide range of genuine parts and accessories are available from our hotline or through our web site.

Genuine parts and accessories, extended warranties and service repairs are all available on our web-site at:



www.theservicecentre.co.uk



Guarantee

"Satisfaction guaranteed or your money back"

We give you a unique 'satisfaction guaranteed' promise - **valid for 90 days** - after you have purchased your Hotpoint appliance. If there is a technical problem simply call Hotpoint Repair service or visit our web-site at www.theservicecentre.co.uk and where necessary, we will arrange for an engineer to call. If the technical problem is not resolved under this guarantee, **we will replace your machine or, if you prefer, give you your money back.**

All Hotpoint appliances carry a fully inclusive 12 month parts and labour guarantee as well as free replacement parts for the first 5 years (except microwaves, selected integrated appliances and cooker hoods, which have a one year guarantee) provided that they are fitted by a Hotpoint engineer.

Guarantee terms and conditions

Your guarantee is only applicable in the United Kingdom or Republic of Ireland and is subject to the following provisions that your appliance:

- Has been installed and used correctly in accordance with this instruction booklet.
- Has been used solely for domestic purposes and is located on domestic premises (ie. not for commercial or trade use).
- Has been properly connected to a suitable electrical supply voltage as stated on the appliance rating plate.
- Has not been subject to misuse, accident, modified or repaired by anyone other than one of our own service engineers.



For pre purchase information on any other Hotpoint product call: 08701 50 60 70
or visit: www.hotpoint.co.uk



Recycling & Disposal Information

As part of Hotpoint's continued commitment to helping the environment, Hotpoint reserves the right to use quality recycled components to keep down customer costs and minimise material wastage. Please dispose of packaging and old appliances carefully.

To minimise risk of injury to children, remove the door, plug and cut mains cable off flush with the appliance. Dispose of these parts separately to ensure that the appliance can no longer be plugged into a mains socket and the door cannot be locked shut.



Key Contacts

After Sales Service

Over 1200 trained specialists, directly employed by us, ensure that you can have complete confidence in both the appliances and services we offer.



Repair Service and Information Desk

UK: 08709 066 066

(Open 8 to 8 Mon - Fri, 8 to 6 Sat, 10 to 4 Sun & Bank Holidays)

www.theservicecentre.co.uk

Republic of Ireland: 1850 302 200

Note: Our operators will require the following information:

Model number:

Serial number:

Extended Warranties

UK: 08709 088 088

(Open 8 to 8 Mon - Sun)

www.theservicecentre.co.uk

Republic of Ireland: 1850 502 200

Genuine Parts and Accessories

UK: 08709 077 077

(Open 8-30 to 5-30 Mon - Fri & 9 to 12 Sat)

www.theservicecentre.co.uk

Republic of Ireland: (01) 842 6836

General Domestic Appliances Limited, Morley Way, Peterborough, PE2 9JB.