

# Hotpoint Service and Spares

FOR SERVICE: If you have a problem with your appliance ring your local Service Office.  
 FOR SPARES and ACCESSORIES: To purchase spares and accessories send your Accessories Order Form to your Spares Centre. If the accessory or spare part you want is not on the form, contact your Spares Centre for prices and availability.  
 Please address all correspondence to Hotpoint Spares Centre or Hotpoint Service Office as applicable.

Service Offices and Spares Centres are open between 8.00am-5.00pm Monday to Friday, except on Public Holidays. 8.30am-12.30pm on Saturdays.

- EAST**
- **ESSEX:** Industrial Buildings, Beehive Lane, Chelmsford, CM2 9TE. Post Codes RM & IG. Tel: (0245) 492433. Remainder of Essex Tel: (0245) 269331
- **LUTON:** 5 Crawley Road, LU1 1HK. Tel: (0582) 452211
- **PETERBOROUGH:** Cella Road, PE2 9JB. Tel: (0733) 64741. Spares Administration Dept. Tel: (0733) 556520
- LONDON**
- **WENBLEY:** 68 East Lane, HA9 7PD. Tel: 081-904 4399. S. Harts and Middlesex. Tel: 081-904 4399. Post Codes N, NW, E, EC. Tel: 081-908 4722. Post Codes W, WC, SE, SW. Tel: 081-906 2511. Tel: 081-904 0201
- **BIRMINGHAM:** Westgate, Aldridge, W Midlands, WS9 8UX. Post Codes B Tel: (0922) 743374. All other Post Codes Tel: (0922) 743376. Tel: (0922) 743377
- **NOTTINGHAM:** Ashing Street, NG2 3JB. For Spares Tel: (0602) 860387. For Service Tel: (0602) 862431/864322. West, Ave, Nelsdon Estate, Talke, ST7 1TN. Tel: (0782) 774511
- **STOKE:**
- NORTH EAST**
- **HULL:** Custom House Building, Whiteliffargate, HU1 2EU. Tel: (0482) 224777
- **WASHINGTON:** 8 Bede House, Tower Road, Glover Est. District 11, NE37 2SH. Tel: 091-417 3500/419 3535
- **WETHERBY:** Sandbeck Lane, LS22 4TW. Tel: (0837) 581261/581444. For Spares Tel: (0837) 581221
- NORTH WEST**
- **KENDAL:** Mumford House, 26 Highgate, LA9 4SX. Tel: (0539) 724483
- **MANCHESTER:** 44/46 Station Road, Heaton Mersey, Stockport, SK4 3QT. Manchester North Tel: 061-432 0513. Manchester South Tel: 061-442 8677. Tel: 061-432 0255
- **NETHERTON:** 7 Bridle Way, Merseside, Tel: 061-525 2342/2524 2339
- **PRESTON:** 24/25 Cannon Street, PR1 3NR. Tel: (0772) 624311
- SCOTLAND**
- **ABERDEEN:** Holbeck House, 68 Carden Place, AB1 1UL. Tel: (0224) 642283
- **EDINBURGH:** 35 West Bowling Green Street, Leith, EH6 5AX. Tel: 031-554 1431
- **BENFREW:** West Lodge Road, Blythswood Estate, PA4 9FN. Tel: 041-866 6241. For Spares Tel: 041-866 5611
- SOUTH**
- **KENT:** Larkfield Trading Est, New Hythe Lane, Larkfield, ME20 6SW. CT, DA, ME & TN Kent Post Codes Tel: (0622) 716571
- **GLoucestershire:** CR, KT, RH, SM Surrey & BR Kent Post Codes (0622) 790707
- **GU:** GU Post Codes in Surrey Tel Southampton (0703) 667374. Tel: (0622) 716631
- **SOUTHAMPTON:** Unit R, S Hampshire Ind Park, Salisbury Rd, Totton, SO4 3SA. Tel: (0703) 861981/867374. For Spares Tel: (0703) 867933
- **SUSSEX:** 1 Kingswood, North St, Hailsham, BN27 1DQ. Tel: (0323) 842733
- **PLYMOUTH:** 69 Mulley Plain, PL4 6JH. Tel: (0752) 262631
- WALES**
- **NORTH:** Conwy Rd, Llandudno Junction, LL31 9RE. Tel: (0492) 582626
- **SOUTH:** 18 Western Ave, Bridgend Ind. Estate, Bridgend, CF31 3SL. Post Codes CF, SA & SY23-25 Tel: (0656) 664121. Post Codes BS, GL, (not 50), HR, SY15-18, LD1-8, NP. Tel: (0656) 655554. Tel: (0656) 766111

In accordance with its policy of progressive product design, the Company reserves the right to alter specifications.  
 Hotpoint Ltd, Peterborough, PE2 9JB, England  
 018/2504/47

# HOTPOINT AQUARIUS ULTRA PLUS DISHWASHER USER HANDBOOK – MODEL 7885

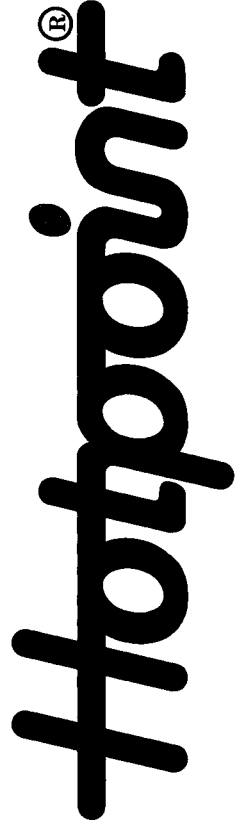

- Service Office and Spares Centre
- Service Office only

<p><b>IRELAND</b></p> <ul style="list-style-type: none"> <li>• <b>NORTHERN:</b> 256 Ormeau Road, Belfast, BT7 2FZ. Tel: (0232) 647111</li> <li>• <b>EIRE:</b> 49 Airways Ind. Estate, Dublin 17. Tel: Dublin 426088. Tel: Dublin 426836</li> </ul>
<p><b>CHANNEL ISLANDS</b> – Service provided by Agents. Normal Guarantees apply and all Service Schemes are available.</p> <p><b>JERSEY:</b> 19 Don Street, St. Helier. Tel: (0534) 21625</p> <p>or</p> <p>Clos D'Ormes, Pontac, St Clements. Tel: (0534) 54808</p> <p><b>GUERNSEY &amp; SARK:</b> Valpys Stores, Grande Rue, St. Maritins, Guernsey. Tel: (0481) 38422</p> <p>or</p> <p>Barras Lane, Vale. Tel: (0481) 51610</p> <p><b>ALDERNEY:</b> 32 High Street. Tel: (0481) 822686</p>
<p><b>ISLE OF MAN</b> – Service provided by Agents. Normal Guarantees apply and all Service Schemes are available</p> <p>from 5 Drumgold St., Douglas. Tel: (0624) 673233</p> <p>or</p> <p>Tromode Works, Cronkbourne Village, Douglas. Tel: (0624) 676066</p> <p>or</p> <p>17 Ridgeway Street, Douglas, Tel: (0624) 25811/25848</p>
<p><b>SHETLAND, ORKNEY &amp; WESTERN ISLES</b> – Service provided by Agents. Normal Guarantees apply, but Service Schemes are NOT available.</p> <p><b>SHETLAND:</b> Fort Road, Lerwick. Tel: (0595) 2557</p> <p><b>ORKNEYS:</b> Halsstone Ind. Estate, Kirkwall. Tel: (0856) 5457</p> <p><b>WESTERN ISLES:</b> 27 Bayhead Street, Stormoway, Isle of Lewis. Tel: (0851) 3387</p> <p><b>OTHER ISLANDS:</b> Local Hydro Electric Shops.</p> <p><b>EXCEPT ARRAN, BUTE &amp; SKYE</b> – Which are covered by Hotpoint.</p>

# Hotpoint Service Cover

## Installation

Follow the Installation Instructions Booklet supplied with the machine. If it is missing please contact your nearest Hotpoint Spares Centre (see back page) for a replacement. Make sure that the machine is correctly installed. Your dishwasher should **not** be located adjacent to a gas heater as flames from the burners could cause damage to your machine.

**WARNING: CHILDREN SHOULD NOT BE ALLOWED TO PLAY WITH THE APPLIANCE OR TAMPER WITH THE CONTROLS.**

**NOTE: Do not attempt to stand or sit on top of your dishwasher, it is not designed for such use and you could injure yourself or damage the appliance by such abuse.**

## Retention of the Instruction Book

This Instruction Book must be kept handy for reference as it contains important details on the safe and proper use of the appliance.

If you sell or pass the appliance to someone else, or move house and leave it behind, make sure this Book is also provided so the new owner can become familiar with the appliance and safety warnings.

If the Book is lost or damaged a copy may be obtained from Spares Dept., Hotpoint Ltd, Ceita Road, Peterborough, PE2 9JB.

## Satisfaction Guaranteed or Your Money Back

Hotpoint gives you a unique 'Satisfaction Guaranteed' promise – valid for ninety days after you have purchased your Hotpoint product. If there is a problem with your Hotpoint appliance just call your Hotpoint Service Office. If necessary we will arrange for an engineer to call. If the problem is not resolved by us under this Guarantee, Hotpoint will replace your appliance or, if you prefer, give you your money back. This Guarantee is additional and subject to the terms of Hotpoint's Five Year Parts Guarantee.

## Hotpoint's Free Five Year Guarantee

From the moment your appliance is delivered,

Hotpoint guarantees it for **FIVE YEARS**.

- In the Five Years all replacement parts are **FREE** provided they are fitted by our own Service Engineer. During the first year our Engineer's time and labour is also free.

- After the first year we will charge for our Engineer's time and labour. We do, however, operate a range of Service Plans (see opposite) which for an annual payment enables you to cover any repair costs which may be necessary
- All of our service repairs are guaranteed for twelve months in respect of our labour and any parts fitted.

- The appliance must be used in the United Kingdom and must not be tampered with or taken apart by anyone other than our own Service Engineer.

- You may, however, buy parts which can be safely fitted without specialist knowledge or equipment. The correct fitting of such parts, provided they are genuine Hotpoint spares, will not affect your Guarantee. Parts are available from our main Hotpoint Spares Centres.

- Our Guarantee does not cover the cost of any repair which is needed because of power cuts, accidents or misuse. Nor does it cover the cost of any visit to advise you on the use of the appliance except for our Free Installation Check for Automatic Washing Machines and Dishwashers. Please read the instruction book thoroughly.

- If at any time during the Guarantee period we are unable to repair your appliance, we will refund any repair costs paid to us in the previous twelve months. We will also offer you a new appliance at a reduced charge instead of a repair.

- Our Guarantee is in addition to and does not affect your legal rights.

- Should you need independent advice on your consumer rights, help is available from your Consumer Advice Centre, Law Centre, Trading Standards Department and Citizens Advice Bureau.

- All Hotpoint servicing is done by our own Service Organisation located throughout the United Kingdom and Southern Ireland. It will be happy to deal with any problems.

## Hotpoint's Installation Check

If you ask at your local Service Office (see back page), Hotpoint will send one of its trained Engineers to make sure that the appliance has been properly unpacked and correctly connected to existing water and electrical supplies.

If you wish, the Engineer will be happy to explain how to use your new appliance.

## Hotpoint's Service Care

Whether you have just one or a number of Hotpoint appliances in your kitchen, Hotpoint has a range of Service Schemes to give you complete peace of mind.

## Service Cover

A single payment covers you for all repairs during the period of cover, which can be from 1 to 4 years. There is also an option of Service Cover with Maintenance at an additional cost. This includes an annual Electrical and Safety check and replacement of any parts as necessary. For 1 year contracts this takes place towards the end of the contract period.

## Kitchen Cover

An annual payment covers you for all repairs for all your Hotpoint appliances which are less than 10 years old. It also covers the cost of loss of food up to £250 in our refrigerator and freezer products. There is also the option of Kitchen Cover with Maintenance at an additional cost. Any additional Hotpoint appliances purchased after you have joined Hotpoint Kitchen Cover will automatically be included during the annual period of cover without further charge.

## Appliance Registration

To ensure that you have the opportunity to benefit from any of the above Service Schemes you should complete and return immediately the Appliance Registration Form supplied with your appliance. Full details and costs of our Service Schemes together with an application form will be sent to you at the end of the first year of the guarantee.

## Annual Safety/Maintenance Checks

Hotpoint strongly recommends that all its appliances are regularly checked for electrical and mechanical safety whether or not they are covered by a Service Plan.

## Proof of Purchase

For future reference please attach your purchase receipt to this booklet and keep it in a safe place.

## Spares and Accessories

Spares and accessories can be ordered from your local Hotpoint Spares Centre (listed on the back page), using the order form enclosed.

**NOTE:** Our Engineer will use every effort to avoid damage to floor coverings and adjacent units when carrying out repairs/service work but in locations where the Engineer advises you that it will be impossible to move the appliance without risk of damage, he will only proceed with your approval that no liability is accepted.

## If it still won't work . . .

### Contact the Service Office

If something is still wrong with your machine after you've been through the check-lists on the previous two pages:

1. Switch off and unplug your machine from the mains.
2. Turn off the hot or cold tap.
3. Call your nearest Hotpoint Service Office or local importer (outside the UK). The telephone number is shown on the back page. You can note down the number in this space for convenience:

.....  
When you contact us we will want to know the following:

1. Your name, address and post code.
2. Your telephone number.
3. Clear and concise details of the fault.
4. The Model number (7885 for this machine), the serial number (found on the top inner trim of the dishwasher) and the colour of the fascia.
5. The date of purchase. Enter the date here:

6. If you have taken out a Hotpoint Service Cover Plan.

Please make sure you have all these details ready when you call.

## Contents

Before you operate your new Dishwasher	Page 4
Get to know the main parts of your Dishwasher	5
How to do a wash	6-7
Dishwasher-proof items	8-9
Setting the Water Hardness Adjuster	10
Salt, Rinse Aid and Detergent	11-13
Loading the Dishwasher	14-16
Programme Guide	17
The Controls	18-21
At the end of a programme	21
Caring for your Dishwasher	22-23
If something goes wrong	24-25
If it still won't work	26
Hotpoint Service Cover	27
Hotpoint Service Offices and Spares Centres	back page

# Before you operate your new Hotpoint Dishwasher

1. **Install your machine**  
see installation booklet

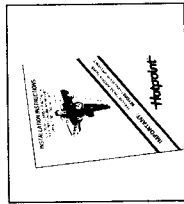

If the installation booklet is missing contact your nearest Hotpoint Spares Centre (see back page) for a replacement.

2. **Read User Handbook**

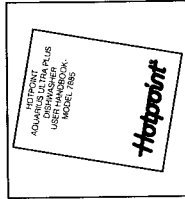

For your own safety and to get the best out of your Dishwasher read right through this Handbook **BEFORE** using your new Dishwasher for the first time.

3. **Get to know the main parts of your Dishwasher**  
see page 5

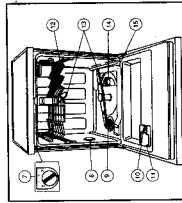

4. **Set Water Hardness Adjuster**  
see page 10

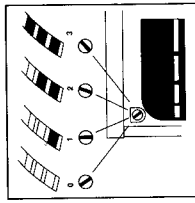

5. **Fill the Salt Container**  
see page 11

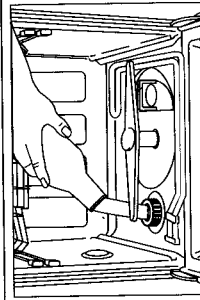

6. **Fill Rinse Aid Dispenser**  
see page 12

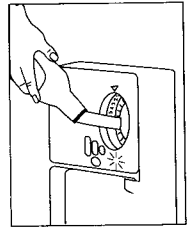

**White deposit left on dishes. Glasses dull or misty**

Possible causes:

1. The salt has run out (see page 11).
2. Rinse aid dosage is set too low (see page 12).
3. Lid of Salt Container not screwed down.

**Glasses have greasy smears**

Make sure that the rinse aid dosage is not set too high (see page 12).

**Dishes still wet after drying**

Make sure that:

1. Rinse aid dosage is not set too low (see page 12).
2. Water can drain off freely and does not collect during drying (see page 14).

**Food specks left on dishes**

Make sure that the filters are properly seated (see page 23).

**Water left under the filter**

This is perfectly normal, especially after using Quick Wash. It will be rinsed away at the start of the next programme.

**Tea/Coffee stains and lipstick left on cups and glasses**

You may be using too little detergent (see page 13).

**Results are unsatisfactory**

Possible causes:

1. Insufficient detergent used (see page 13).
2. Not correctly loaded/Overloaded baskets (see page 14).
3. Salt needs filling (see page 11)
4. Incorrect rinse aid setting (see page 12).
5. Filters incorrectly fitted or blocked (see page 23).
6. Nozzles in spray arm blocked (see page 23).
7. Spray arms obstructed by the load (see page 14).
8. Incorrect programme selected (see page 17).

**Rattling noises**

Make sure that:

1. The utensils are correctly arranged (see page 14).
2. The spray arms are not being obstructed.

**Discolouration of some plastic parts inside the dishwasher**

This is a normal reaction of some plastics to certain soils, water supplies and detergents. It will not affect the operation of these parts.

## If something goes wrong . . .

First, don't panic! There may be nothing wrong at all.

Look for your problem below, then check the things we suggest. More often than not this will give you the answer to your problem, and you'll be able to carry on without having to telephone your Hotpoint Service Office.

If after this you still cannot get your machine to work, follow the advice given on page 26.

### Problem

#### Check these things first

Make sure that:

1. The machine is plugged in and switched on at the socket.
2. The door is securely closed.
3. You have selected a programme and switched on.
4. The water supply is turned on.
5. The hoses are not kinked.
6. The fuses in the plug and main fuse box are OK.

Try plugging in another appliance to check. If the fuse has blown refer to Electrical Requirements in the Installation Handbook.

### It won't fill

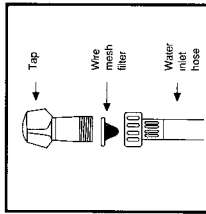

Make sure that:

1. You have not forgotten to turn on the tap.
2. The inlet hose is not kinked.
3. You inspect the filter fitted into the water inlet hose (see diagram).

### It won't empty

Make sure that:

1. The drain hose is not kinked.
2. The filters are not blocked (see page 23).

### The machine's leaking

Make sure that:

1. The inlet hose is firmly attached to the water supply.
2. If your machine **is not** permanently plumbed in; that you emptied the hose into a bucket after disconnecting it from the tap.
3. If your machine has a standpipe it is at the correct height (500mm/20in min) and it is the correct bore size (32mm/1¼in min)
4. The water is not due to normal condensation.
5. You turn off the water supply.

## Get to know the Main Parts of your Dishwasher

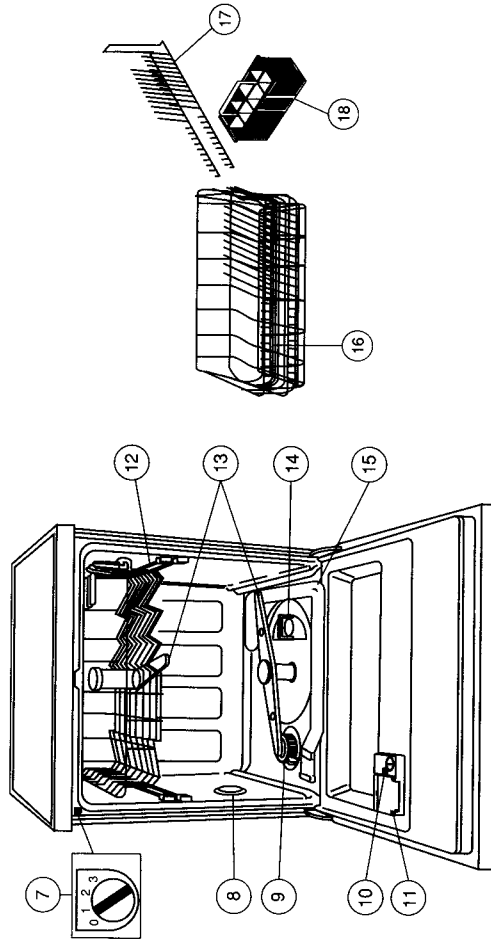
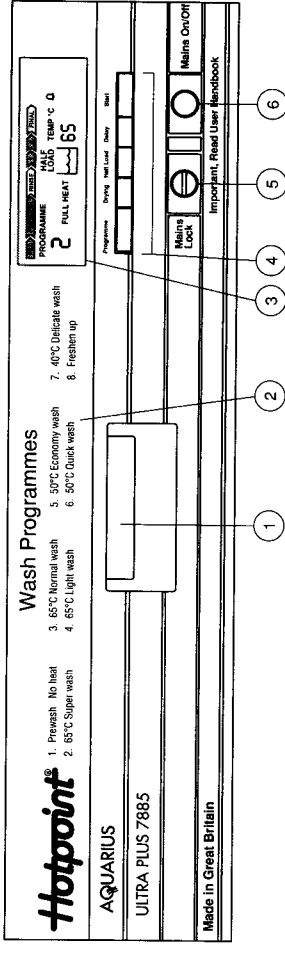

- |   |                          |
|---|--------------------------|
| 1. Door release                                   | 10. Rinse Aid Dispenser  |
| 2. Programme Guide                                | 11. Detergent Dispenser  |
| 3. Display Panel                                  | 12. Upper Basket         |
| 4. Programme Selector Buttons                     | 13. Spray Arms           |
| 5. Mains Lock                                     | 14. Filters              |
| 6. Mains On/Off Button                            | 15. Heater Element       |
| 7. Vent, to allow steam to condense during drying | 16. Lower Basket         |
| 8. Salt Container Cap                             | 17. Removable Plate Rack |
|   | 18. Cutlery Basket       |

## How to do a wash

For your own safety and to get the best out of your dishwasher read right through this Handbook before using your new dishwasher for the first time. Once you have read through the Handbook the summary on pages 6 and 7 will remind you of how to operate the dishwasher.

- 1. Turn on water**

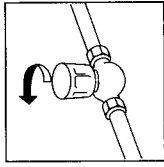

- 2. Plug in, switch on electricity by pressing mains on/off button**

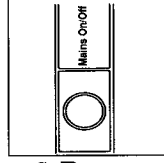
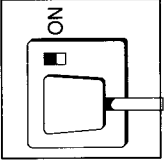

**WARNING:**  
WHEN SWITCHING ELECTRICITY ON OR OFF PLEASE ENSURE THAT YOUR HANDS ARE DRY.

- 4. Check the Salt Refill Indicator**  
see page 11

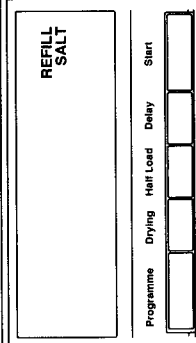

REFILL SALT will appear in the display panel when the salt container needs refilling. After filling ensure that the container is completely topped up with water and the cap is replaced and tightened securely.

- 5. Check Rinse Aid Refill Indicator**  
see page 13

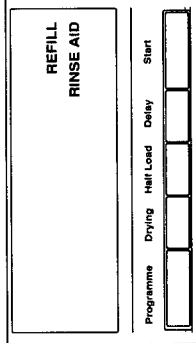

REFILL RINSE AID will appear in the display panel when the rinse aid dispenser needs refilling. After filling ensure that the cap is replaced and tightened securely.

- 6. Check filters**  
see page 23

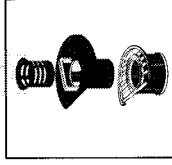

Make sure that filters are clean and correctly positioned.

- 7. Load machine**  
see page 15

Do not obstruct the spray arms or detergent dispenser. Make sure that items are dishwasher proof.

- 8. Add Detergent**  
see page 13

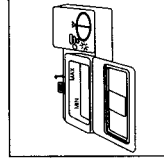

Add relevant quantity of detergent based on the type of wash programme to be selected. Make sure that the detergent dispenser door is closed.

- 9. Close dishwasher door**

Make sure that dishwasher door clicks shut.

## Cleaning the Filters

**This is the most important item of maintenance you have to do.**

The filters are found in the bottom of the machine on the right-hand side (see page 5).

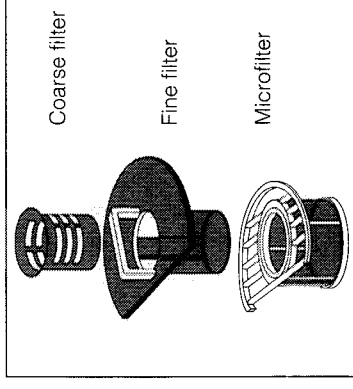

The coarse and fine filters can be lifted out by the handle on the fine filter. They can be pushed together and pulled apart. They should be cleaned under running water after every wash.

The microfilter is a push fit device which sits in the base of the machine and can be removed by lifting straight upwards.

Inspect after every wash and clean when necessary, and at least after every five washes.

When replacing make sure that the microfilter clips firmly into place and that the edges are flush with the base of the machine. The coarse and fine filters should then be reassembled and located back inside the microfilter, again with the edges flush with the base of the machine.

## Removing the Spray Arms for Cleaning

Both spray arms can be taken out of the dishwasher for easy cleaning.

The **lower spray arm** clips into place and can be removed by lifting upwards.

The **upper spray arm** can be removed as follows:

1. Pull out the upper basket.
2. Line up the slots in the funnel and body.
3. Place a ruler or handle of a spoon in the slots to stop the funnel rotating.
4. Turn the Spray Arm clockwise and it will undo and can be removed.

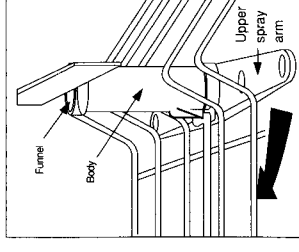

The Funnel can also be removed but take care not to lose the white washer which acts as a bearing.

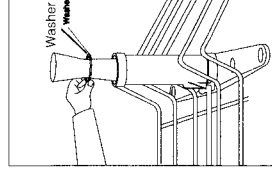

Remember to replace spray arms securely after cleaning.

# Caring for your Dishwasher

Your Hotpoint Dishwasher needs very little attention. The following steps will keep it performing well.

**NOTE: Before doing any cleaning check that the electricity supply to the machine is switched off.**

1. Clean the spray arms occasionally. To do this, remove the arms (see page 23) and brush them under fresh running water or use a mild soap or detergent solution. They need to be kept clean to keep the jets clear and spraying properly.
2. Clean the metal surfaces on the outside of your machine with a damp cloth only. **Do not use** any abrasive cleaners or metal polishes, otherwise you will damage the protective coating on these parts.
3. Clean the rubber door seals by wiping with a damp cloth.
4. If the machine is not going to be used for a long time leave the door ajar to allow air to circulate inside.
5. We recommend you take out a Hotpoint Service Cover Plan with Annual Safety/Maintenance Check which ensures the machine is professionally serviced every year. Details are given on page 27 of this Handbook.

Hotpoint strongly recommends that all of its appliances are regularly

checked for electrical and mechanical safety whether or not they are covered by a Hotpoint Service Cover Plan. This is to avoid such things as worn hoses which may cause a leak on an appliance which could become dangerous if neglected.

**WARNING: IT IS POSSIBLE FOR CHILDREN TO CLIMB INTO DISHWASHERS AND INJURE THEMSELVES. ALWAYS SWITCH OFF AT SOCKET AND REMOVE PLUG AFTER USE.**

## 10. Select programme see page 18

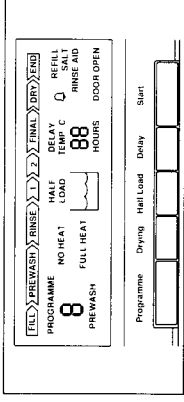

Press the function buttons to display the required programme. Then press the 'Start' button.

## 11. Programme Progress Indicator see page 20



The Programme Progress Indicator along the top of the display panel shows what stage the cycle has reached.

## 12. Switch off the machine see page 21

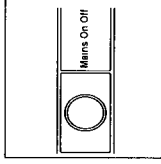

When the machine has completed its programme press the mains On/Off button.

## 13. Switch off electricity

**WARNING: WHEN SWITCHING ELECTRICITY ON OR OFF PLEASE ENSURE THAT YOUR HANDS ARE DRY.**

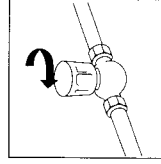
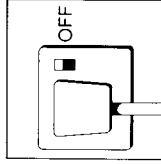

## 14. Turn off water

## 15. Remove wash load see page 21

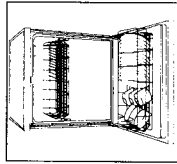

Allow 15 minutes for the load to cool. Unload lower rack first.

**WARNING: The load may be hot**

## 16. Clean the filters. see page 23

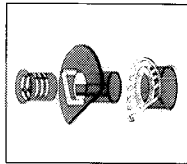

Remember to clean the filters.

## What items are not dishwasher-proof?

This is always the first question asked by anyone who has bought a dishwasher for the first time, so we will answer it before we go any further.

The items **not** suitable for washing in a dishwasher are:

- Cutlery with wooden or bone handles
- Pans with wooden handles
- Items which have parts joined by glue
- Copper or tin items
- Plastic items which are not heat resistant
- Hand made craft items
- Lead crystal glassware.

### Please note

Colours painted over a glaze may fade after many washes.  
Clouding may occur on glasses after frequent washing.

### We recommend

Wash delicate glassware on the Gentle programme. This will lessen the risk of clouding.  
There are no standard guidelines for washing glassware. When in doubt wash by hand.  
When purchasing new dishes, make sure they are dishwasher safe.

**If you are in any doubt check with the manufacturers of the china, pans, and cutlery on their dishwasherability.**

To re-set the machine press the Mains On/Off button to switch it off, then press again to switch back on, reselect your programme and Optional Features and press Start. If the error persists and you have gone through the Checklist on pages 24 to 25 then remove the load and turn to page 26 'If it still won't work...'

## Can I only wash dishes in my dishwasher?

No, there are many more items you can wash in a dishwasher than you imagine, for example:

Oven furniture, hob fittings, stainless steel items, teapots, coffee pots, glass microwave turntables, food processor and mixer attachments.

**WARNING: DO NOT ATTEMPT TO WASH ITEMS IN YOUR DISHWASHER WHICH HAVE CONTAINED POISONOUS OR DANGEROUS SUBSTANCES.**

## At the end of a programme

The machine stops automatically when the programme is finished.

### Switching off

The first thing you should do is to switch the machine off by releasing the Mains Lock (if used), pressing the Mains On/Off button (Display Panel will clear) and switching off the power at the mains socket.

### Turn off the water

When you have finished washing always turn off the water at the stopcock, or tap.

If you do not have permanent plumbing you will also need to disconnect the water supply and stow the drain hose after emptying it in a bucket.

### Unloading

Allow the load to cool for about 15 minutes.

Unload the lower rack before the upper rack to avoid any drops of water falling on the lower dishes when the upper rack is moved.

**WARNING: NEVER TOUCH THE HEATER ELEMENT AS THIS CAN REACH EXTREMELY HIGH TEMPERATURES.**



## Special care notes

### Bleep Signals

At various times when using your machine you will hear a bleep or series of beeps, the following table describes what they mean.

Number of Bleeps	Reason
1	Acknowledges your command when you press a button at any time ie. machine beeps every time you press a key before <b>or</b> after start.
2	Tells you that you have left the door open, or that there is an Error Condition.
3	Tells you that the machine has finished. (End of Programme)

If you wish to stop the End of Programme beeps, simply press the Delay button once before pressing Start. The  symbol will then disappear from the display panel.

If the door is not closed after a programme has been selected an audible warning (of two beeps) will be given and 'door open' flashes on the Display Panel until you close the door.

### Error Conditions

If a fault occurs during the machine's cycle an 'E' and an error code is shown in the display and the machine will automatically empty of water. At this point the machine will beep twice and repeat every two seconds.

### Starting the Machine

Start the machine by pressing the Start button.  
If you realise that you have made a mistake after pressing Start you can still cancel the programme by releasing the Mains On/Off button to switch the machine off, then press again to switch back on, and reselect your programme and optional features.

**NOTE:** If the Mains Lock has been used you will have to release it before you are able to press the Mains On/Off button.

### Programme Progress Indicator

During the programme the relevant section of the Progress Indicator will appear on the display panel to show what stage the programme has reached.

For example:



The Indicator moves from left to right along the top of the display panel as shown above.

### Stainless steel items

Stainless steel is very good for washing in the dishwasher. Some types however can become tarnished by the humid atmosphere in the dishwasher during drying.  
To avoid this remove the items at the end of the rinse programme and wipe dry.

Any staining will not harm the items and can be removed with a proprietary stainless steel cleaner.

### Silverware

Silverware can be washed in your dishwasher but should not be washed alongside stainless steel items as this could cause corrosion of the stainless steel.

To 'polish' tarnished silver and A1 EPNS, a *Silverware Cassette* can be purchased. See accessories order form. Only silver cutlery is to be placed in the *Silverware Cassette*. It is placed in the cutlery basket and the silver cutlery placed inside. The areas of discolouration will disappear after a few washes.

The cassette should be removed when not in use.  
It should be noted that any decorative toning on the handles of silverware will eventually fade, so if this is of particular importance to you do not wash such items in the dishwasher.

### Aluminium items

Bright polished, matt, enamelled and non-stick coated aluminium items are all suitable for washing in a dishwasher.

However aluminium is vulnerable to everyday minerals found in water, which could lead to discolouration during rinsing. If items show signs of discolouration they should be removed immediately after the washing cycle and rinsed in cold water by hand. This discolouration will not, however, seriously affect the aluminium.

**WARNING: TAKE SPECIAL CARE WHEN REMOVING ITEMS IMMEDIATELY AFTER A WASH AS THEY MAY BE VERY HOT, AND STEAM MAY BE EMITTED FROM THE DISHWASHER WHEN THE DOOR IS OPENED.**

## Setting the Water Hardness Adjuster

In order to ensure the correct amount of salt is being used to regenerate the water softener the Water Hardness Adjuster needs to be set accordingly. The Water Hardness Adjuster is located in the top left hand corner of the dishwasher (see page 5). To set this you need to establish the degree of hardness of your water supply.

This is very easy to do by carrying out the following steps.

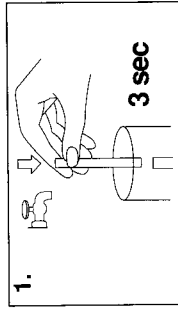

1. Take the test strip (supplied with this handbook) out of its plastic seal and dip it for 3 seconds into a container of cold mains water so that all three zones of the strip are covered.

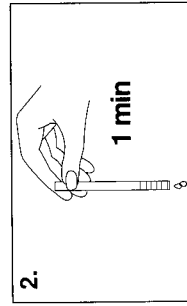

2. Remove the test strip from the water, wait for one minute and observe any colour change.

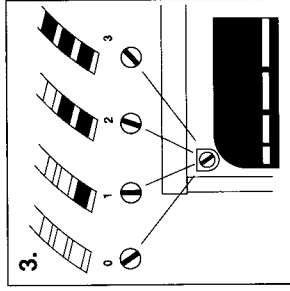

3. If all three areas remain greenish you are in a soft water area. Set the Water Hardness Adjuster to 0, by using a screwdriver or coin.

If one of the three zones turns reddish the Water Hardness Adjuster should be set at 1.

If two zones turn reddish you are in a hard water area and the Water Hardness Adjuster should be set at 2.

If all three zones turn reddish you are in a very hard water area and the Water Hardness Adjuster should be set at 3.

If in any doubt, please consult your nearest Hotpoint Service Office for advice (see back page).

**After setting the Water Hardness Adjuster you will need to add salt to the machine.**

## Half Load Feature

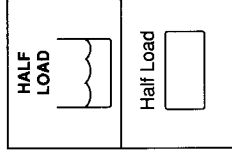

The Half Load feature can be used when you do not have a full load.

Press the Half Load button, you will hear a bleep and the display will show that the option has been selected. To cancel press the button again so that the option disappears from the display panel.

NOTE: Half Load will not operate on the Prewash programme.

## Delay Hours

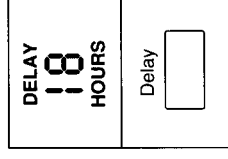

This feature can be used to delay the time (minimum 1 hour up to a maximum period of 18 hours) when you want any of the wash programmes to **Finish**.

To use the Delay Hours, press the Delay button once, the buzzer goes off, press the Delay button twice and the display will show a delay of 1 hour. If the button is held in the display will show an increase in delay hours up to 18 and will keep repeating until you release the button, thus setting the time delay you require.

Press the Start button and the selected delay time alternating with temperature display will flash on and off. As the delay period progresses the display will decrease in hours to show the time left to the end of the programme.

## NOTE:

If a delay time is selected that is shorter than the selected programme then the machine will start the wash programme as soon as the Start button is pressed.

Use of the Time Delay will suppress the bleep signal at the End of the Programme.

When the Delay Hours feature is not selected the wash temperature for the programme will be shown in the display panel.

## Mains Lock

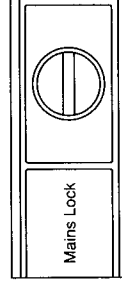

When you are happy with your choice of programme you can operate the security lock. This will lock the Mains On/Off button so that it cannot be accidentally operated.

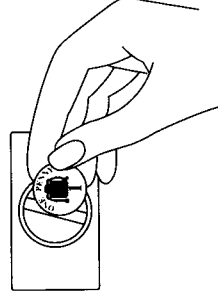

To operate the locking system insert a coin into the slot and turn through 90° clockwise. To release turn through 90° anti-clockwise.

# The Controls

## Switching On and Off

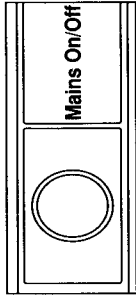

To switch the machine on simply press the mains on/off button and **On** plus **On** will appear in the Display Panel.

## Selecting a programme

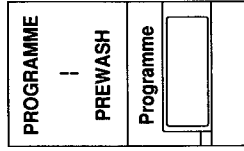

Press and hold in the Programme Selector button, you will hear a bleep and see 'PROGRAMME 1 PREWASH' appear in the display. Programmes 2-8 will follow appearing in sequence at approximately half second intervals. This sequence will keep cycling as long as the Programme Selector button is pressed in.

As the sequence progresses you will notice that the type of drying and temperature shown on the display panel changes to coincide with the wash programmes.

To select a programme, wait until

the required programme is displayed and then release the Programme Selector button.

The programme guide on page 17 will help you select the right programme for the load you are washing.

If you make a mistake and select the wrong programme press the Programme Selector button and the programme selection cycle will start again.

## Optional Wash Features

### Drying

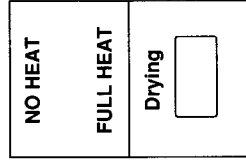

Programmes 'Prewash 1' and 'Quick Wash 6' are preset to 'NO HEAT' drying and cannot be altered.

The other programmes are preset to 'NO HEAT' drying but can be changed to 'FULL HEAT' drying by pressing the Drying Selector button. You will hear a bleep and the display will show that the 'FULL HEAT' option has been selected. 'NO HEAT' drying means that the heating element does not operate during the drying period and the load dries from the residual heat of the last rinse water.

# Salt, Rinse Aid and Detergent

In order to function properly your dishwasher needs a supply of the above three items. Salt and rinse aid are replenished occasionally whilst detergent is added every time you wash a load.

Various manufacturers sell dishwasher rinse aid and detergent, most of which are suitable for your Hotpoint dishwasher. We particularly recommend *Sun* rinse aid and detergent as they give excellent results on all programmes and loads.

## Salt

Salt is used to regenerate the resins in the water softener which aids both washing and rinsing, and avoids the furring-up of the internal parts of the machine. In areas with very soft water you will not need to add salt very often but you should occasionally use it to avoid the risk of furring-up.

**NOTE: Only use special granular or tablet salt. Do not use table salt, cooking salt or road salt as they contain insoluble substances which could harm the dishwasher.**

When using the dishwasher for the first time it is necessary to fill the Salt Container.

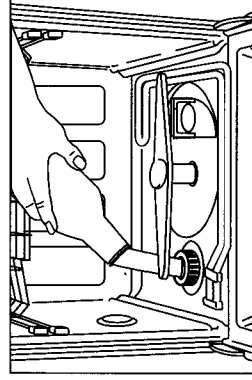

The Salt Container will then need refilling when indicated on the Display Panel.

## How to fill the Salt Container

The Salt Container is located on the bottom left-hand side of the dishwasher (see page 5). Remove the lower basket and turn the Salt Container Cap anti-clockwise to remove it.

When the machine is new pour in 0.5 litre (1 pint) of water and then add 1 1/2-2 kg (3 1/2-4 1/2 lb) of granular salt or 1 kg (2 1/4 lb) of tablet salt. Water may overflow from the container when you are adding salt.

After adding the salt, and before replacing the cap, ensure that the container is completely filled with water – top up as necessary. Replace the cap ensuring that it is securely tightened. Select and run the Prewash programme, (see page 18 for programme selection), which will rinse away any spilled salt solution.

## Salt Refill Indicator



REFILL SALT will appear in the display panel when the salt container needs refilling.

The indicator may still show immediately after adding salt as it takes time for the water to dissolve the salt.

## Rinse Aid

Rinse aid ensures quick drying and avoids the water spots and streaks which normally occur when a wet object is allowed to dry in the air.

**NOTE: Only use rinse aid designed for use in dishwashers, do not use normal washing-up liquid.**

When using the dishwasher for the first time it is necessary to fill the rinse aid dispenser and set the dosage as the dispenser will automatically add the rinse aid to the final rinse water.

The rinse aid dispenser will then need refilling when indicated on the Display Panel.

### How to remove the Rinse Aid Dispenser Lid.

The Rinse Aid Dispenser is located inside the dishwasher door (see page 5).

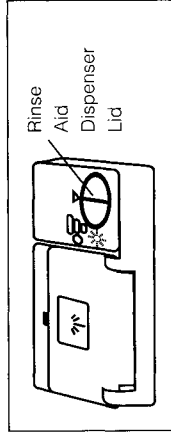

Remove the lid by turning it  $\frac{1}{4}$  turn anti-clockwise and lifting it off.

### How to set the dosage

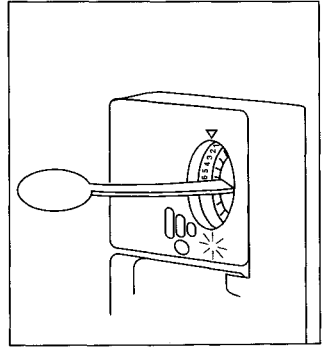

The dispenser automatically adds rinse aid to the final rinse. The amount it dispenses can be adjusted by placing a teaspoon in the slot as shown.

Any position from 1-6 can be chosen, the higher numbers dispense more rinse aid. We suggest that you initially set it between 4 and 5 and then adjust it in the light of your own experience.

Page 25 highlights the faults found on washing with too much or too little rinse aid.

### How to fill the Rinse Aid Dispenser

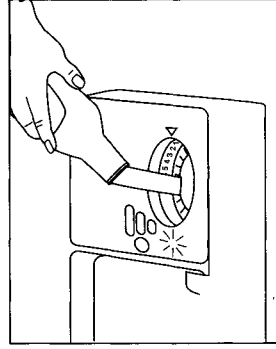

Fill the dispenser with Rinse Aid. The container holds approximately 100ml/ $\frac{1}{4}$  pint.

Refit the Rinse Aid Dispenser lid ensuring that it is firmly in position.

## Programme Guide

Programme	Action	Detergent	Type of load and soil level	Programme Time (mins)*	
				Cold Fill	Hot Fill
1. Prewash	Unheated prewash	-	For use on all items being held until a full load is available	10	10
2. Superwash 65°C	Unheated prewash, 65°C wash, 2 cold rinses, 65°C rinse, residual heat drying	30g	Heavily soiled items, pots & pans, cooking utensils, oven/hob fittings, daily dishes	85	60
3. Normal wash 65°C	Unheated prewash, 65°C wash, cold rinse, 65°C rinse, residual heat drying	25g	Suitable for most normally soiled everyday crockery, glasses and cutlery	75	55
4. Light wash 65°C	65°C wash, cold rinse, 65°C rinse, residual heat drying	25g	Lightly soiled daily dishes, glassware and cutlery	60	50
5. Economy wash 50°C	50°C wash, cold rinse, 65°C rinse, residual heat drying	25g	Glasses, cutlery and slightly soiled crockery washed immediately after use	55	45
6. Quick wash 50°C	50°C wash, cold rinse, 50°C rinse, residual heat drying	25g	Glasses, cutlery, slightly soiled crockery washed immediately after use. Items which are required quickly	35	25
7. Delicate wash 40°C	Unheated prewash, 40°C wash, 2 cold rinses, 65°C rinse, residual heat drying	25ml Liquid detergent	For items which require care when washing. Fine china, glasses	70	60
8. Freshen up	Cold rinse, 65°C rinse, residual heat drying	-	Use whenever it is sufficient to rinse and dry crockery, ie. crockery previously washed but not used for a long time	40	35

\* These times are approximate as they are dependent upon your household water temperature and pressure.

Programme times will be reduced slightly if the Half Load feature is selected. If the Half Load feature is selected the detergent may be reduced to approximately 15g.

## Using the Lower Basket

The lower basket has only one fixed position, and is rolled along the open dishwasher door for loading.

Use the lower basket for plates, serving dishes, pots, pans, heavily soiled items and cutlery.

The plate rack in the rear of the lower basket can be removed enabling larger pans, casseroles and dishes to be accommodated.

To do this push in the bar on the right hand end of the rack (arrow 1) and then lift clear of the basket (arrow 2).

To refit, reverse the process.

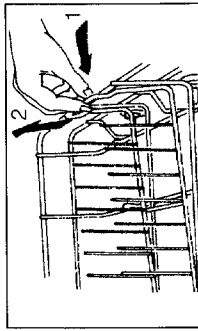

Load the basket from the back and work forwards.

Arrange plates facing towards the centre of the basket and so that they are not touching and water can flow freely between them.

Arrange all items so that water can drain away.

Cutlery should be randomly loaded in the cutlery basket with all the handles downwards, except if the handles are very thin and could drop through the basket and interfere with the action of the lower spray arm.

**NOTE:** Care should be taken when loading and unloading sharp knives.

Silver cutlery should be placed in a silverware compartment which can be purchased as an optional extra. See the accessories order form.

Long cutlery, such as ladles and large knives should be laid horizontally across the cutlery basket or laid in the upper basket.

**NOTE:** Heat resistant plastic items should not be placed in the lower basket in case they become dislodged and come into contact with the heater element.

**ALWAYS REPLACE THE LOWER BASKET BY ROLLING IT INTO THE DISHWASHER ALONG THE OPEN DOOR.**

## Half Load

When washing a half load arrange the crockery in both the upper and lower baskets so that the water can flow freely around them.

## Rinse Aid Refill Indicator

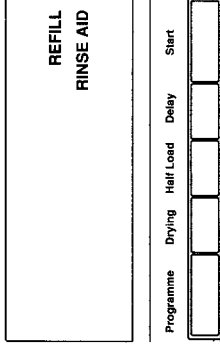

REFILL RINSE AID will appear in the display panel when the rinse aid dispenser needs refilling.

## Detergent

The Detergent Dispenser is located inside the dishwasher door next to the Rinse Aid Dispenser (see page 5). The Detergent Dispenser should be filled before each wash (except prewash).

**NOTE: Only use special dishwasher detergent. Do not use ordinary washing-up liquids or washing powders.**

## Filling the Detergent Dispenser

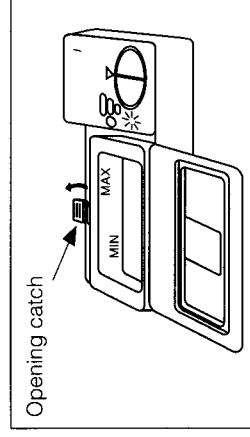

Press the opening catch on the dispenser as shown. The lid will spring open. The lid will always be open at the end of a programme.

Put the detergent into the dispenser (the MIN line is approximately 25g). The Programme Guide on page 17 suggests detergent quantities for each programme, however the effectiveness of different detergents can vary so follow manufacturers recommendations and adjust the amount of detergent used accordingly.

Close the dispenser lid firmly so that it clicks shut.

The lid will automatically spring open during the programme to release the detergent.

## NOTE:

**Dishwasher detergent should always be added at the beginning of a programme. If you forget to add detergent switch the machine off, add detergent and then reselect programme.**

## Loading the Dishwasher

Your dishwasher is designed to take 12 standard place settings. There is no one correct method for loading the dishwasher. The upper and lower baskets are designed to give the maximum flexibility possible to cope with the almost infinite variety of cups, glasses, dishware, pots, pans and utensils – not to mention your oven fittings or teapot – which might be put into them.

Before loading the crockery remove all excess food, as you would for hand washing.

Very soiled pots and pans should be allowed to soak in water before placing in the dishwasher so that any food sticking to the bottom and sides comes away more easily.

### Using the Upper Basket

The height of the upper basket can be adjusted according to the space required by the items being washed. There are two height levels provided by the two sets of rollers on the basket.

### To change the height of the upper basket:

Pull the basket out as far as it will go. Unlock the plastic end stops on the runners by holding the runner rails firmly and moving the end stops outwards (ie. towards the sides of the machine (see diagrams)). You will then be able to pull the basket completely out of the runners.

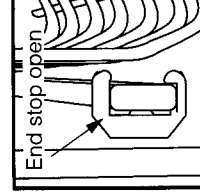
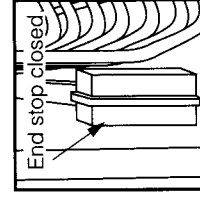

Replace the basket into the runners on the upper rollers (A) or on the lower rollers (B).

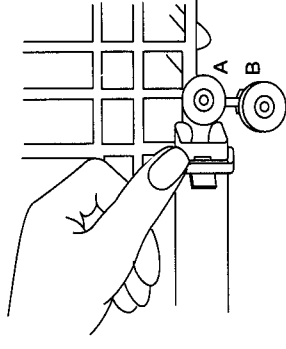

Return the end stops into their original closed position.

Check that the basket moves freely in its runners.

Use the upper basket for glasses, cups, saucers, side plates, dessert bowls, small dishes, fragile crockery and heat resistant plastic items.

Arrange all items so that water can drain away. Cups, glasses, bowls, etc. should be placed upside down. The upper basket has two racks for cups, their height is adjustable and they can be removed if not required.

**Do not** cover the funnel in the centre of the upper basket.

After loading check that the upper spray arm is free to rotate by giving it a spin with your hand.

### WARNING:

**ALWAYS CHECK THAT PLASTIC AND WOODEN ITEMS ARE SECURELY LOADED SO THAT THEY CANNOT BECOME DISLODGED AND COME INTO CONTACT WITH THE HEATER ELEMENT.**

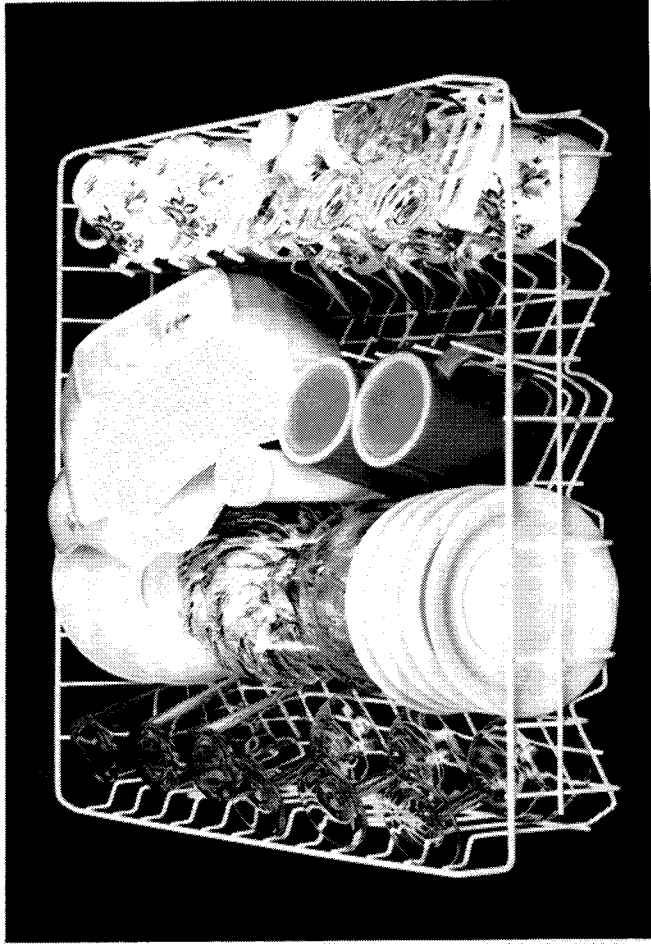

Upper Basket

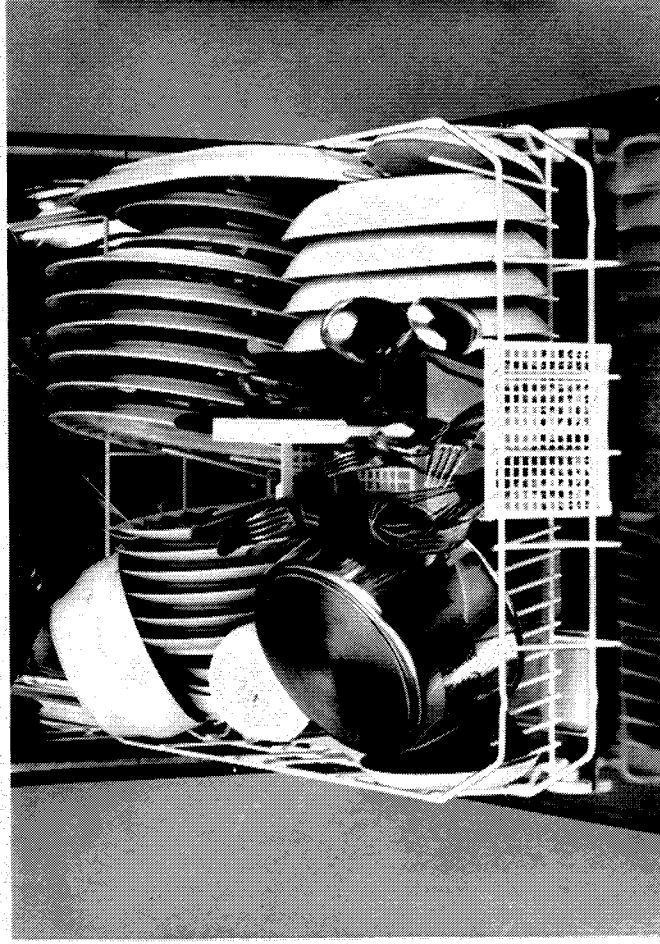

Lower Basket