

# Haier

**Domestic Dishwasher**

**HDW300SS**

**HDW300WH**



Code:0120505074

# Safety Is a Good Habit to Get Into

## IMPORTANT

Carefully read the instructions contained in this manual, as it provides information that is essential to safe and proper installation, use and maintenance of this appliance.



This appliance complies with following EEC directives:

- 73/23/EEC of 19/02/73 (Low Voltage) and subsequent modifications;
- 89/336/EEC of 03/05/89 (Electromagnetic Compatibility) and subsequent modifications.
- Carefully dispose of the packing material.
- After removing the packing, check to make sure that the appliance is not damaged. If in doubt, contact a qualified professional.
- The dishwasher must only be used by adults for the washing of household dishes and cooking utensils.
- Fundamental rules to follow when using the appliance:
  - \* Never touch the dishwasher with wet hands;
  - \* We discourage the use of extension cords and multiple sockets;
  - \* During installation, the power supply cord must not be excessively or dangerously bent or flattened;
  - \* If the appliance is not operating properly or, requires maintenance, disconnect the appliance from the power supply.
- Keep detergents out of the reach of children. Also keep children away from the dishwasher when it is open to reduce the risk of injury.

- This appliance cannot be installed outdoors or exposed to the rain and elements. Not even if the area in which it is installed is covered by a roof. It is very dangerous.
- Do not lean or sit on the door when it is open, as this could overturn the dishwasher.
- If the appliance malfunctions, turn off water supply to the appliance and disconnect the plug from the wall socket. Then, refer to the "Troubleshooting". If you cannot resolve the problem, contact an authorised service agent.
- Only specialised personnel are authorised to make repairs.
- Appliances which are being discarded must be made inoperable by cutting the power supply cord and removing the door lock.
- The appliance must be positioned so that the plug or isolating switch is accessible.
- If the supply cord is damaged, it must be replaced by the manufacturer or an authorised service agent.

## Warning:

*Dishwasher Detergents can be extremely dangerous, if swallowed. Avoid contact with skin and eyes and keep children away from the dishwasher when the door is open.*

*Check that the detergent receptacle is empty after completion of the wash cycle.*

## Close-up View (control panel)

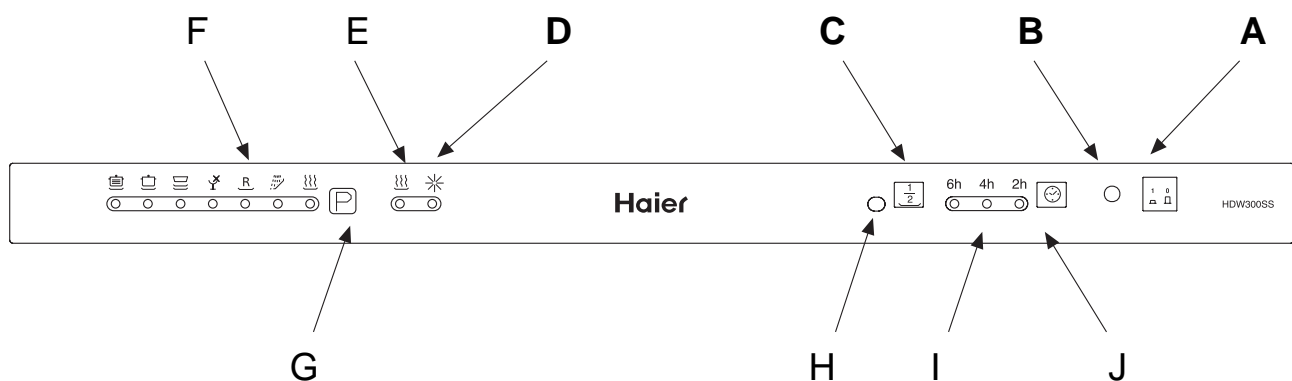

- |   |                               |   |                             |
|---|-------------------------------|---|-----------------------------|
| A | ON-OFF Button                 | F | Cycle indicator light       |
| B | ON-OFF Light                  | G | Cycle select button         |
| C | "HALF LOAD" Button            | H | "HALF LOAD" indicator light |
| D | Low rinse aid indicator light | I | Delay indicator light       |
| E | Water heating indicator light | J | Delay select button         |

## Close-up View (Interior)

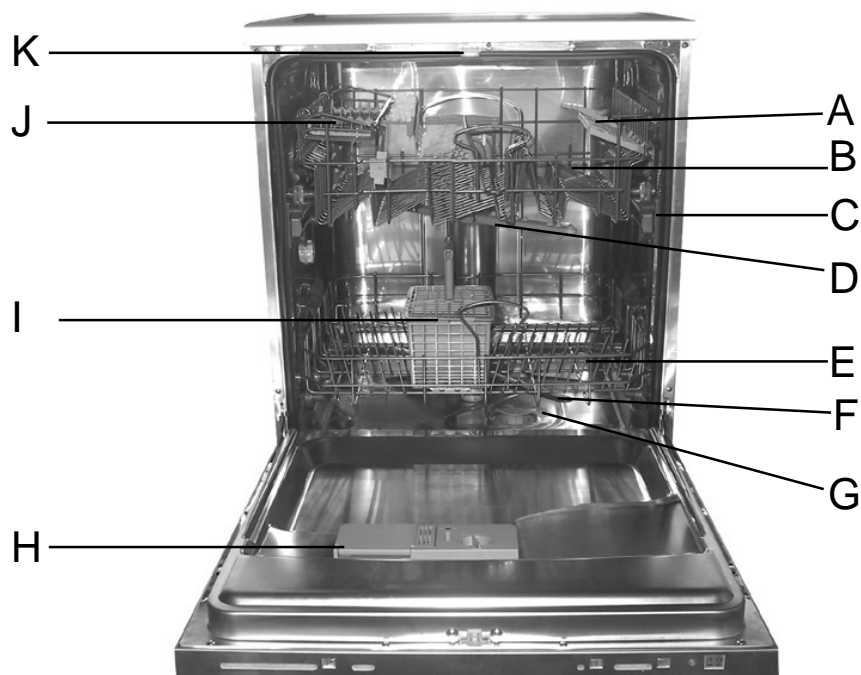

- |                        |                                     |
|------------------------|-------------------------------------|
| A Cup Rack             | G Washing Filter                    |
| B Upper Rack           | H Detergent and Rinse Aid Dispenser |
| C Rack Height Adjustor | I Silverware basket                 |
| D Top Spray Arm        | J Knife rack                        |
| E Lower Rack           | K Third Sprayer                     |
| F Bottom Spray Arm     |                                     |

---

### Technical characteristics

Width	60 cm
Depth	60 cm
Height	85 cm
Capacity	12 standard place settings
Mains water pressure	0.03-0.6MPa
Power voltage	220-240V~ 50Hz
Total absorber power	2150W

# Detergent and Rinse Aid... ..

## Detergent

Detergent specifically intended for use with dishwashers must be used. The dispenser must be refilled before the start of each wash cycle following the instructions provided in the "Wash Cycle Table". The detergent dispenser is located on the inside panel of the door.

## Loading the detergent

To open the "A" cover on the dispenser, press the "B" button. The detergent for the wash cycle should be poured into the "C" compartment.

After the detergent has been placed in the dispenser, close the cover and press down until it clicks into place.

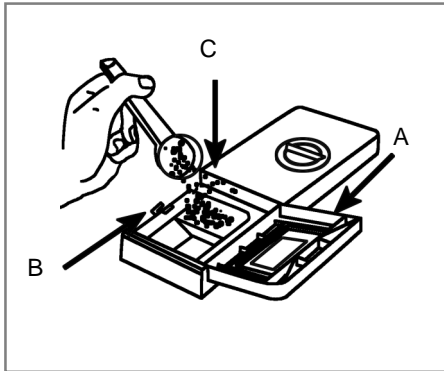

**Notice:** To enable the cover to close, remove any excess detergent from the edges of the dispenser.

## Rinse Aid

This product makes dishes sparkle and helps them to dry without spotting. The dispenser is located on the inside panel of the door and should be filled after approx every 80 wash cycles (or when the "low rinse aid" indicator light comes on for those models with this feature).

## Loading the Rinse Aid

Regardless of the type of detergent dispenser installed on your appliance, you must proceed as indicated below when loading the rinse aid.

To open the dispenser, turn the "C" cap in an anti-clockwise direction and then pour in the rinse aid, making sure not to overfill. The amount of rinse aid used for each cycle can be regulated by turning the "F" dose adjuster, located beneath the "C" cap, with a screwdriver. There are 6 different settings; the normal dosage setting is 1.

## Important

**Proper dosage of the rinse aid improves drying.**  
**If drops of water remain on the dishes or spotting occurs, the dosage adjuster should be turned to a higher setting.**  
**If the dishes have white streaks, turn the dosage adjuster to a lower setting.**

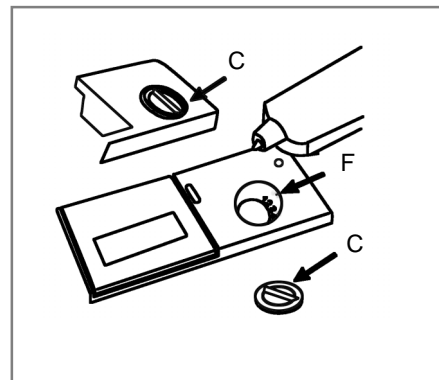

# Loading the Dishwasher

Before placing the dishes in the dishwasher, remove larger food particles to prevent the filter from becoming clogged, which results in reduced performance.

If the pots and pans have baked-on food that is extremely hard to remove, we recommend that they are soaked before washed. This will eliminate the need for extra wash cycles.

Pull out the rack to load the dishwasher.

## How to use the lower rack

We recommend that you place the most difficult to clean items on the bottom rack: pots, pans, lids, serving dishes and bowls, as shown in the figure to the right.

It is preferable to place serving dishes and lids on the sides of the racks in order to avoid blocking the rotation of the top spray arm.

- Pots, serving bowls, etc. must always be placed face down.
- Deep pots should be slanted to allow the water to flow out.
- The lower rack features fold down tine rows (see fig.A) so that larger or more pots and pans can be loaded.
- The silverware basket can be halved (see fig.B) so that only one section may be used when the silverware load is light. This also makes space for additional pots and pans and it can also be placed in the upper rack.
- Silverware should be placed in the silverware basket with the handles at the bottom; if the rack has side baskets, the spoons should be located individually into the appropriate slots. Long utensils should be placed in a horizontal position in the upper rack.

## How to use the upper rack

The upper rack is designed to hold more delicate and lighter dishware, such as glasses, cups and saucers, plates, small bowls and shallow pans (as long as they are not too dirty).

- Position the dishes and cookware so that they do not get moved by the spray of water.

The upper rack can be adjusted for height by using the knobs located on both sides of the rack itself (see fig.C).

Adjust the upper basket to the higher level and you have more space to accommodate those taller pans and trays in the bottom basket.

## Shelf

Lean tall glasses and those with long stems against the shelf-not against other items to be washed.

Place glasses, cups and small bowls on the additional cup rack. The additional cup rack can be swivelled in or out as required(see fig.D).

## Knife rack

The knife rack clips onto the side of the top basket, giving you the freedom to wash your large sharp knives separately and out of harm's way (see fig.E).

Lower Rack

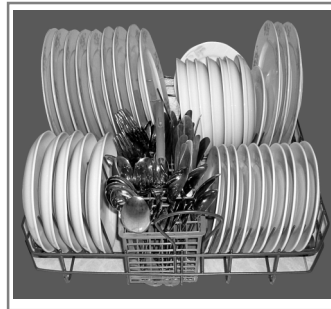

Upper Rack

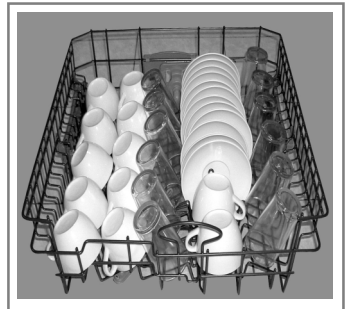

Load for 12 Standard Settings

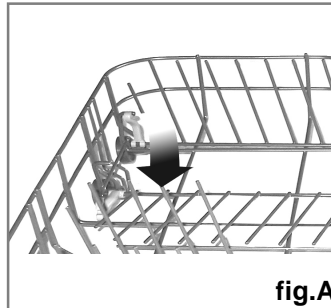

fig.A

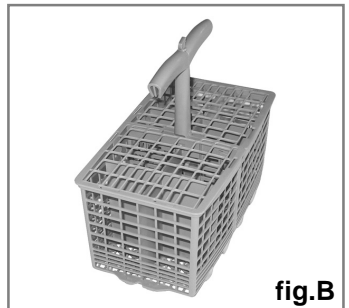

fig.B



fig.C

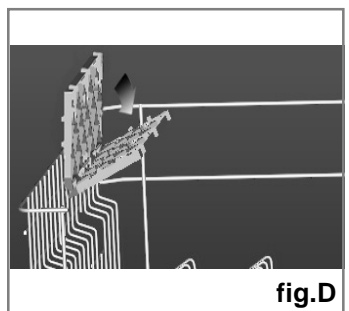

fig.D

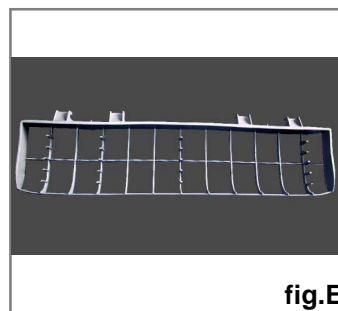

fig.E

# Starting the Appliance

## Starting a wash cycle...

After having completed all of the installation steps in the preceding paragraphs, turn on the water to the unit, partially open the door of the dishwasher, and press the ON-OFF button "A" located on the control panel. The "B" indicator light will come on. At this point, the appliance is on and ready to be programmed.

## Setting and Starting a wash Cycle

Choose the desired cycle by pressing the cycle selection button "G". Each time it is pressed, the cycle indicator lights "F" will change to indicate the cycle selected.

Choose the wash cycle you feel is most appropriate for the type of dishes that need washing (consult the wash cycle table contained in this manual, especially when first using the appliance). Close the door and after a few seconds, The wash cycle will begin. Read the paragraph entitled, "Cancelling or changing a cycle while underway." "The end of the cycle will be signalled by six beeps, and the indicator light "F" will extinguish.

## Cancelling or changing a cycle while underway...

Premise: A cycle that is underway can only be changed if it has only been running for a short time.

Otherwise, the detergent may have already been used, and the appliance may have already drained the wash water. If this is the case, the detergent dispenser must be refilled (see the paragraph entitled, "Loading the Detergent").

To change the cycle currently underway, open the door, press the "G" programming button and hold it in for about 5 seconds. Once the cycle has been cancelled, the dishwasher will emit a short acoustic sound and the relative indicator light will turn off.

To set a new wash cycle, follow the instructions contained in the paragraph entitled, "Setting and Starting a Wash Cycle."

## At the end of the wash cycle...

Six beeps will indicate that the wash cycle has finished and the cycle indicator light "F" will begin to extinguish. Open the door, turn off the appliance using the ON/OFF switch and turn off the water supply to the unit. Wait a few minutes before removing the dishes so as to avoid handling them while still hot (when they are more susceptible to breakage) and to get better drying results.

## Setting The Start Delay Time

Open the door of the dishwasher partially. Press button "J" (see, Close-up View" Control Panel") to delay the starting time for a wash cycle.

.1st press, "2h" indicator comes on, the cycle will start in 2 hours.

.2nd press, "4h" light indicator comes on, the cycle will start in 4 hours.

.3rd press, "6h" light indicator comes on, the cycle will start in 6 hours.

.4th press, "2h" and "6h" light indicators come on, the cycle will start in 8 hours.

.5th press, "4h" and "6h" light indicators come on, the cycle will start in 10 hours.

.6th press, "2h", "4h" and "6h" light indicators come on, the cycle will start in 12 hours.

.last press, all light indicators will extinguish and you can reset. After selecting the delay time, the wash cycle can be set, as explained in "Starting a wash cycle..." There will be a short acoustic signal, and at this point the delay period will begin to count down. During this period the delay indicator light (I) will blink. At the end of the delay time, the indicator will stop blinking and the cycle will start.

### NOTE:

a) During the delay period, none of the settings can be modified. If necessary, they can be cancelled by pressing cycle selector "P" for about 5 seconds.

b) If the power to the appliance goes off or the door is opened during the delay period, the clock will stop the countdown. It will start again when the power has come back on, or when the door has been closed.







## Wash Cycle Adjustment Buttons

### 1/2 Load Button

This button (see" Close-up View-Control Panel", letter "C") makes it possible to wash dishes using only the upper rack if there are not enough dishes for a full load, This will allow you to save on water and electrical energy.

It cannot be used with the heavy duty wash cycles.

## Wash Cycle Table

Cycle	Cycle Selection Information	Description of Cycle	Detergent	Rinse Aid
 Intensive	Very dirty dishes, pots and pans. (Not to be used with delicate items)	Pre-wash with hot water. Extended wash at 70°C. Rinse with cold water. Rinse with hot water. Drying.	30g	★
 Normal Wash	Normal dirty dishes, pots and pans. Standard daily cycle.	Pre-wash with cold water. Extended wash at 50°C. Rinse with cold water. Rinse with hot water. Drying.	5+25g	★ (5)
 Light Wash	Normal dirty dishes, pots and pans without dried on residue.	Pre-wash with cold water. Extended wash at 50°C. Rinse with cold water. Rinse with hot water. Drying.	30g	★
 Glassware	Economic, fast cycle to be used for delicate items which are sensitive to higher. Run immediately after dishes are used.	Wash at 45°C. Rinse with warm water. Hot rinse. Drying.	15g	★
 Rapid Wash	Economic, fast cycle to be used to on not very dirty dishes right after they are used. No drying cycle.	Short wash at 40°C. Cold rinse.	15g	
 Rinse	Pre-wash of dishes, pots and pans while waiting for the load to be completed after the subsequent meal.	Short cold wash to prevent food residue from drying on the dishes .		
 Heat wash	The cycle of heat washing and dry tableware.	Heat washing.		★

## Energy Saving Tips

-It is important to try and run the dishwasher when it is fully loaded in order to save on energy. In order to prevent odors from forming and food from caking onto the dishes, you can run the soak cycle.

-Choose the right wash cycle: the choice of cycle depends on the type of dishware, cookware and utensils being washed and how dirty they are.

-Use the right amount of detergent: if you use too much detergent, the result will not be cleaner dishes, but, rather, a greater negative impact on the environment.

## How to keep Your Dishwasher in Shape

### After Every Wash

After every wash, turn off the water supply to the appliance and leave the door slightly ajar so that moisture and odors are not trapped inside.

### Remove the plug

Before cleaning or performing maintenance, always remove the plug from the socket. Do not run risks.

### No solvents or Abrasive Cleaning Products

To clean the exterior and rubber parts of the dishwasher, do not use solvents or abrasive cleaning products. Rather, use only a cloth and warm soapy water.

To remove spots or stains from the surface of the interior, use a cloth dampened with water and a little white vinegar, or cleaning product made specifically for dishwashers.

### When You Go on Holiday

When you go on holiday, it is recommended that you run a wash cycle with the dishwasher empty and then remove the plug from the socket, turn off the water supply and leave the door of the appliance slightly ajar. This will help the seals last longer and prevent odours from forming within the appliance.

### Moving the Appliance

If the appliance must be moved, try to keep it in a vertical position. If absolutely necessary, it can be positioned on its back.

### Seals

One of the factors that cause odours to form in the dishwasher is food that remains trapped in the seals. Periodic cleaning with a damp sponge will prevent this from occurring.

## Cleaning and Special Maintenance

### Filter Assembly

For best performance and results, the filter assembly must be cleaned frequently.

The filter efficiently removes food residue from the wash water, allowing it to be recirculated during the cycle. For this reason, it is a good idea to remove the larger food particles trapped in the filter after each wash cycle by rinsing the "A" semi-circular filter and cup under running water. To remove the filter assembly, pull on the cup handle in an upward direction. The entire filter assembly (made up of the "A" semicircular filter and the "B" fine filter) should be cleaned at least once a week.

To clean the filter and the fine filter, use a cleaning brush. Then, reassemble the filter parts as shown in the figures below and reinsert the entire assembly in the dishwasher, positioning it in its seat and pressing downward.

The dishwasher must never be used without the filters. Improper replacement of the filters may reduce the performance level of the appliance and damage dishes and utensils.



### Cleaning the Spray Arms

※Check the spray arms periodically and clean them when needed.※

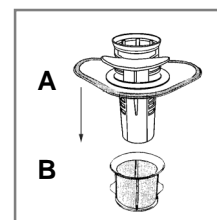

### Cleaning the Water Inlet Filter

Periodically clean the water inlet filter (see figure) located on the outlet of the water supply tap.

After turning off the water tap, unscrew the end of the water supply hose, remove the filter and clean it carefully under running water. Then, return the filter to its place and tighten the water supply hose back into position.



# Troubleshooting

If the dishwasher does not function or does not function properly. Before calling for assistance, check to see what can be done first: have you forgotten to press one of the buttons or to perform an essential operation?

## The Dishwasher Does Not Start

Have you checked whether:

- the plug is pushed into the socket correctly;
- the power is on in the house;
- the door is closed properly;
- the ON-OFF switch is on "ON";
- the water supply is turned on.

## The Dishwasher Does Not Fill With Water

Have you checked whether:

- the water is turned on and the hose is connected properly;
- the water supply to the house is on and has sufficient pressure;
- the water supply hose is crimped or bent;
- the filter in the water supply hose is clogged.

## The Dishes Are Not Clean

Have you checked whether:

- Dishwasher was loaded properly. Jets of water could not reach all parts of the dishes, etc;
- Too many items in the rack;
- Items in the rack were touching each other;
- Not enough detergent was added to dispenser;
- Selected wash programme was intensive enough;
- Rotation of spray arm was obstructed by dish, etc;
- Nozzles in spray arm are blocked by remnants of food;
- Coarse or fine filter or microfiller is blocked;
- Filters have been incorrectly fitted;
- Drain pump is jammed;

## The Dishwasher Does Not Drain

Have you checked whether:

- the drain hose is crimped or bent.

## Lime Deposits or a White Film Form on the Dishes

Have you checked whether:

- the rinse aid dosage is correct.

## Error Messages

The dishwasher is equipped with a safety system that is able to detect operating problems and malfunctions. These malfunctions are signalled by the rapid blinking of one of the "M" program LEDs. Only in the case where the indicator light for the soak cycle (see table for cycles) blinks rapidly should you cancel the cycle as described in the section entitled, "Changing a Cycle while Underway." Then check to make sure that there is water in the mains and that the tap is turned on. If the problem continues, call for technical assistance, indicating which light was flashing.

If any of the other indicator lights begin to blink rapidly, turn off the appliance and call for technical assistance, advising which lights were flashing.

If, despite all these checks, the dishwasher still does not function and/or the problem persists, contact the nearest authorised service centre and provide them with the following information:

- the nature of the problem;
- the model number AND serial number, which are on the plate located on the side of the inner part of the door.

**Never call on unauthorised technicians and refuse to allow parts to be installed that are not original spare parts.**

# Installation

## Positioning the Appliance

Positioning the appliance in the desired location. The back should rest against the wall behind it, and the sides, along the adjacent cabinets or wall. The dishwasher is equipped with water supply and drain hoses that can be positioned to the right or the left of the appliance.

## Levelling the Appliance

Once the appliance is positioned, adjust the feet (screwing them in or out) to adjust the level of the dishwasher. The appliance should not be inclined more than 2°. If it is level, it will help ensure proper performance.

## Cold Water Connection

Connect the cold water supply hose to a threaded 3/4 (gas) connector, making sure that it is fastened tightly in place (see fig.1). If the water pipes are new or have not been used for an extended period of time, let the water run to make sure that the water is clear and free of impurities. If this precaution is not taken, there is a risk that the water inlet filter may get blocked and damage the appliance.

## Hot Water Connection

The water supply to the appliance can also be connected to the house's hot water line (centralised system, heating system), as long as it does not exceed a temperature of 60°C.

In this case, the wash cycle time will be shortened by about 15 minutes and the wash efficiency slightly reduced.

The connection must be made to the hot water line following the same procedures as those for the connection to the cold water line.

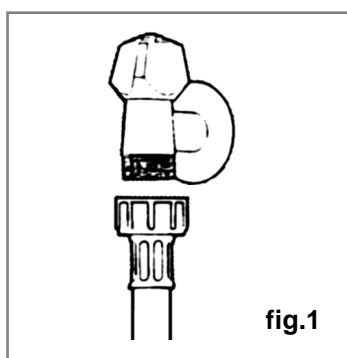

## Drain Hose Connection

Insert the drain hose into a drain pipe with a minimum diameter of 4cm. Or let it run into the sink, making sure to avoid bending or crimping it. Use the special plastic support that comes with the appliance (see fig.2). The free end of the hose must be at a height between 40 and 100 cm and must not be immersed in water.

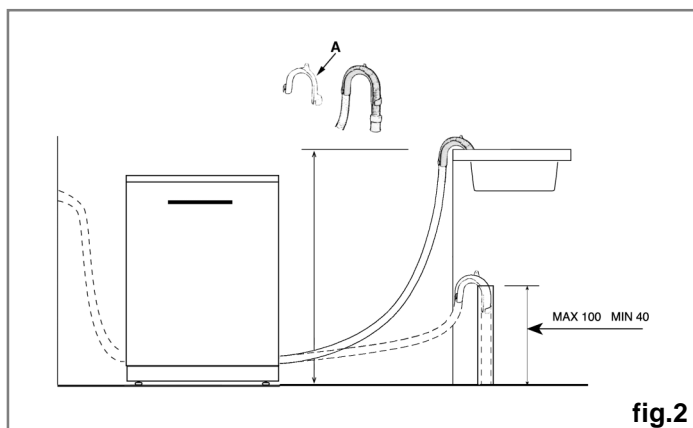

## Attention:

*The special plastic hose support must be solidly fastened to the wall to prevent the drain hose from moving and allowing water to spill outside the drain.*

## Electrical Connection

After making sure that the voltage and frequency values for the current in the home correspond to those on the rating plate (located on the stainless steel inner door of the appliance) and that the electrical system is correct for the maximum voltage on the rating plate, insert the plug into an electrical socket which is earthed properly (the earthing of the appliance is a safety requirement mandated by law).

If the electrical socket to which the appliance must be connected is not appropriate for the plug, replace the plug, rather than using adaptors or the like as they could cause overheating and burns.

## Caution:

The dishwasher plug must be accessible even when the appliance is installed as a built-in unit so that maintenance can be done safely.

# Installation

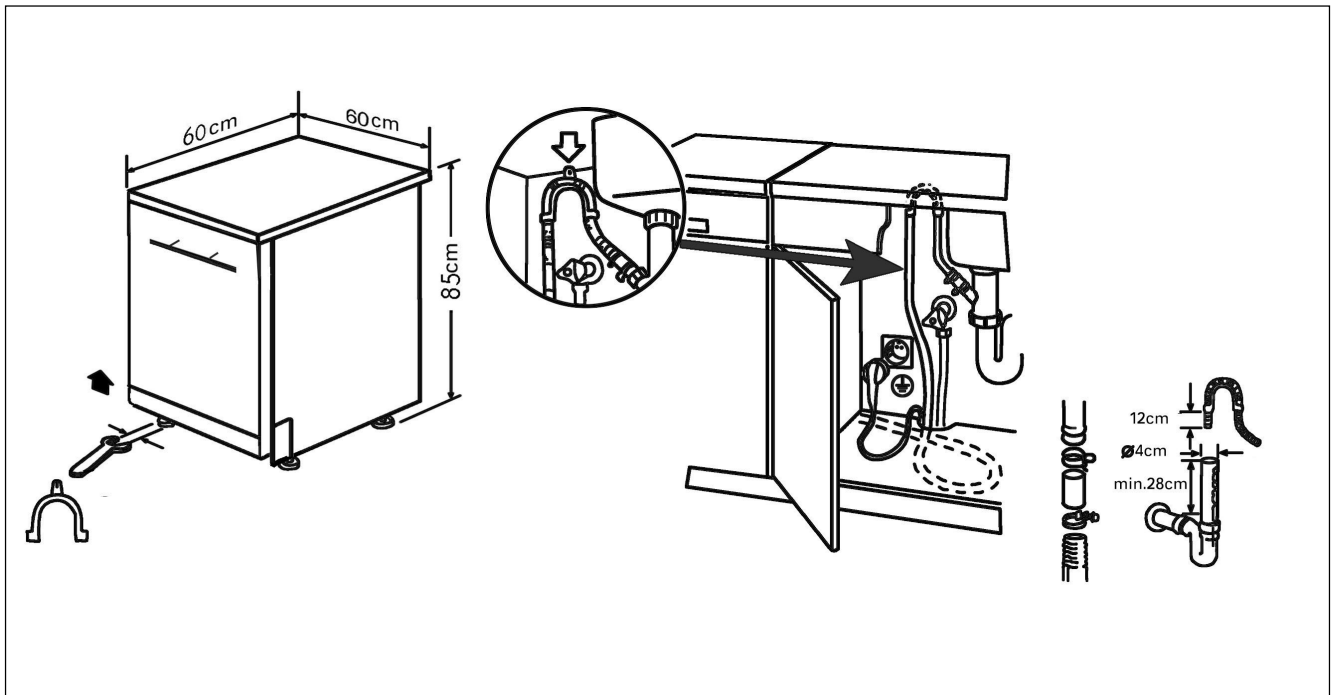

# Diagram

