

Haier

Dishwasher

DW12-PFE2-U

DW12-PFE2ME-U

Instructions for Use

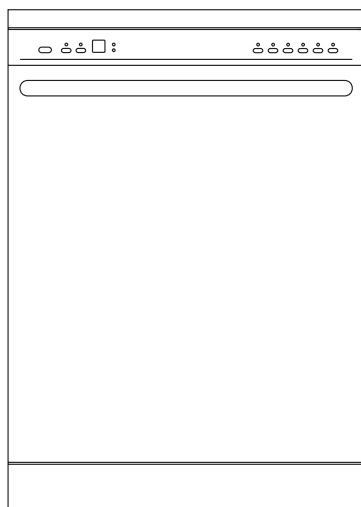

Index

| | |
|---|----|
| Safety information | 2 |
| Installation | 4 |
| Getting to know your dishwasher | 6 |
| How to fill the salt | 7 |
| How to fill rinse aid | 9 |
| How to fill the detergent dispenser | 9 |
| Not suitable for the dishwasher | 10 |
| Arranging crockery, glasses, etc. in the dishwasher | 11 |
| Programme overview | 13 |
| Washing dishes | 15 |
| How to keep your dishwasher in shape | 18 |
| Care and maintenance | 19 |
| Fault finding | 21 |
| Technical data | 25 |
| Important information | 25 |

Safety information

At time of delivery

- Check packaging and dishwasher immediately for signs of transport damage. If the appliance is damaged, do not put it into use but contact your supplier or customer service without delay.
- Please dispose of packaging materials properly.

During installation

- Site the dishwasher and connect it up in accordance with the installation instructions.
- The dishwasher must not be connected to the electricity supply while installation is being carried out.
- Ensure that the domestic wiring is properly earthed.
- The mains electricity supply must conform to the details shown on the dishwasher nameplate.
- Do not connect the dishwasher to the electricity supply via an extension cable.
- Built-under and built-in appliances should always be installed under a continuous work surface which is attached to the adjacent cupboards, in order to ensure that the appliance is entirely stable.
- After the appliance has been installed, the mains plug should still be easily accessible.
- During installation, the power supply cord must not be excessively or dangerously bent or flattened.

During normal use

- The dishwasher must only be used by adults for the washing of household dishes and cooking utensils.
- This appliance cannot be installed outdoor, not even if the area in which it is installed is covered by a roof; it is also very dangerous to leave it exposed to the rain and elements.
- Do not place any heavy objects or stand on the door when it is open. The appliance could tip forward.
- The water inside the dishwasher is not suitable for drinking.
- Do not use solvents of any kind inside your dishwasher. They could cause an explosion danger. Open the door very carefully if the dishwasher is operating. There is a risk of water squirting out.
- Do not touch the heating element during or after a wash cycle.
- Fundamental rules to follow when using the appliance:
 - Never touch the dishwasher when barefoot or with wet hands or feet;
 - We discourage the use of extension cords and multiple sockets;
 - If the appliance is not operating properly or maintenance must be performed, disconnect the appliance from the power supply.

If your family includes children

- The appliance is not intended for use by young children or infirm persons without supervision.
- Young children should be supervised to ensure that they do not play with the appliance.
- Keep detergents out of the reach of children, who must also be kept away from the dishwasher when it is open.

If a fault occurs

- If the appliance malfunctions, turn off water supply to the appliance and disconnect the plug from the wall socket. Then, consult the section entitled, "Fault finding". If you cannot solve the problem, contact a service center.
- Only specialised personnel are authorised to make repairs.
If the supply cord is damaged, it must be replaced by the manufacture, its service agent or similarly qualified persons in order to avoid a hazard.
- To maintain the EFFICIENCY and SAFETY of this appliance, we recommend:
 - call only the Service Centers authorized by the manufacturer.
 - always use original Spare Parts.

When disposing of old appliances

- Appliances which are no longer being used must be made inoperable by cutting the power supply cord and removing the door lock.
- Take the appliance to a designated waste disposal center.



Dangerous voltage



Warning

Children could get locked in the appliance (risk of suffocation) or get stuck in other positions. Therefore: Remove the mains plug, cut the mains wire and set aside. Damage the door lock so that the door can no longer be closed.

Installation

Positioning the appliance

Positioning the appliance in the desired location. The back should rest against the wall behind it, and the sides, along the adjacent cabinets or wall. The dishwasher is equipped with water supply and drain hoses that can be positioned to the right or the left to facilitate proper installation.

Levelling the appliance

Once the appliance is positioned, adjust the feet (screwing them in or out) to adjust the dishwasher, making it level. In any case, the appliance should not be inclined more than 2°. If the appliance is level, it will help ensure proper performance.

Cold water connection

Connect the water supply hose to a threaded 3/4" (gas) connector, making sure that it is fastened tightly in place (see fig.A).

If the water pipes are new or have not been used for an extended period of time, let the water run to make sure that the water is clear and free of impurities. If this precaution is not taken, there is a risk that the water inlet can get blocked and damage the appliance.

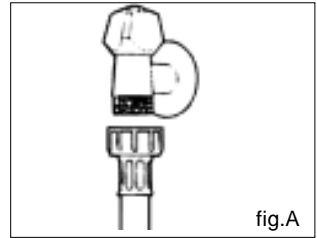

Warning

The appliance is to be connected to the water mains using new hose-sets and that old hose-sets should not be reused.

Drain hose connection

Insert the drain hose into a drain pipe with a minimum diameter of 4cm, or let it run into the sink, making sure to avoid bending or crimping it. If necessary, fit a syphon trap (U-bend) with a connecting piece for the drain hose (fig.B). The free end of the hose must be at a height between 40 and 100 cm and must not be immersed in water.

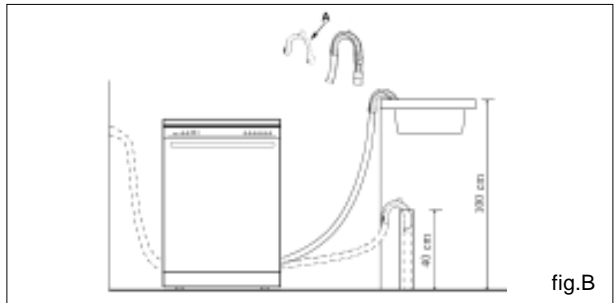

Attention:

The connecting piece for syphon trap (U-bend) must be solidly fastened to the wall to prevent the drain hose from moving and allowing water to spill outside the drain.

Electrical Connection

After making sure that the voltage and frequency values for the current in the home correspond to those on the rating plate (located on the stainless steel inner door of the appliance) and that the electrical system is correct for the maximum voltage on the rating plate, insert the plug into an electrical socket which is earthed properly (the earthing of the appliance is a safety requirement mandated by law). If the electrical socket to which the appliance must be connected is not appropriate for the plug, replace the whole cable, rather than using adaptors or the like as they could cause overheating and burns.



Caution:

The dishwasher plug must be accessible even when the appliance is installed as a built-in unit so that maintenance can be done safely.

ELECTRICAL CONNECTION (UK ONLY)

For your safety please read the following information.

Warning: This appliance must be earthed.

The appliance must be connected to a 220-240 volts 50 cycle AC supply by means of a three pin socket, suitably earthed and should be protected by a 13 amp fuse in the plug.

The appliance is supplied with a rewireable 13 amp 3-pin plug fitted with a 13-amp fuse. Should the fuse require replacement, it must be replaced with a fuse rated at 13 amp and approved to BS1362.

If the mains plug is unsuitable for the socket outlet in your home or is removed for any other reason, then the cut off plug should be disposed of safely to prevent the hazard of electric shock. Remove the fuse before disposal.

There is a danger of electric shock if the cut off plug is inserted into any 13-amp socket outlet.

How to wire a 13 amp plug.

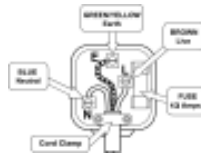

Important

The wires in the mains lead on this appliance are coloured in accordance with the following code:

Green and Yellow - Earth

Blue – Neutral

Brown – Live

As the colours may not correspond with the markings identifying the terminals in your plug proceed as follows.

The green and yellow wire must be connected to the terminal in the plug which is marked with the letter E or with the earth symbol \equiv or coloured green and yellow.

The blue wire must be connected to the terminal marked N.

The brown wire must be connected to the terminal marked L.

You must make sure the lead is firmly secured under the cord clamp.

Getting to know your dishwasher

Close-up view (control panel)

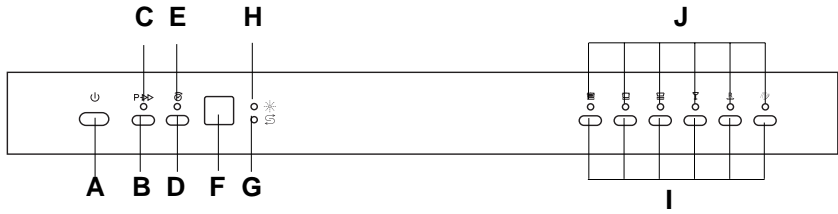

A ON-OFF Button

B "Speedup Wash" Button

C "Speedup Wash" Indicator

D Delayed Start Button

E Delayed Start Indicator

F Time-remaining Indicator

G Low Salt Indicator

H Low Rinse Aid Indicator

I Programme Button

J Programme Indicator

Dishwasher interior

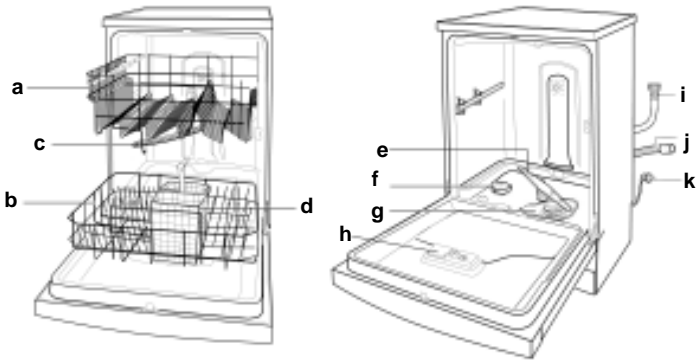

a Upper Rack

b Lower Rack

c Top Spray Arm

d Silverware Basket

e Bottom Spray Arm

f Salt Container Cap

g Washing Filter

h Detergent and Rinse Aid Dispenser

i Water Inlet Hose

j Drain Hose

k Power Supply Cord

How to fill the salt

Salt

The hardness of the water varies from place to place. If hard water is used in the dishwasher, deposits will form on the dishes and utensils.

The appliance is equipped with a special softener that uses a salt specifically designed to eliminate lime and minerals from the water.

Loading the salt into the container

Always use salt intended for use with dishwashers.

The salt container is located beneath the lower rack and should be filled as follows:

- When the low salt indicator “1” lights, you must fill the salt.
- Remove the lower rack and then unscrew and remove the cap from the salt container;
- If you are filling the container for the first time, fill it with water;
- Place the end of the funnel (supplied) into the hole and introduce about 2 kg of salt. It is normal for a small amount of water to come out of the salt container.
- Carefully screw the cap back on.

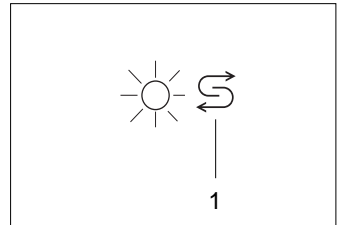

Important

To prevent the formation of rust, load the salt just before beginning a wash cycle.

Adjusting salt consumption

The dishwasher is designed to allow for adjusting the amount of salt consumed based on the hardness of the water used. This is intended to optimize and customize the level of salt consumption so that it remains at a minimum.

To adjust salt consumption, proceed as follows:

- Unscrew the cap from the salt container;
- There is a ring on the container with an arrow on it (see figure to the side),
- If necessary, rotate the ring in an anticlockwise direction from the "-" setting towards the "+" sign, based on the hardness of the water being used.

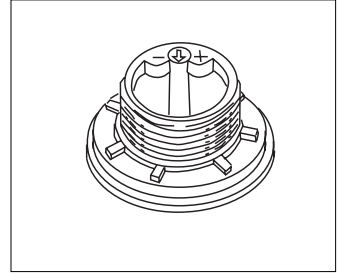

It is recommended that adjustments be made in accordance with the following table:

| Water Hardness | | | | | | |
|----------------|----------------|-------|---------|-------------------|--------------------------------|-----------------------|
| Level | Clarke degrees | °dH | mmol/l | Selector position | Salt consumption (Grams/cycle) | Autonomy (cycles/2kg) |
| 1 | 0 14 | 0 17 | 0 1,7 | / | 0 | / |
| 2 | 14 36 | 18 44 | 1,8 4,4 | " - " | 20 | 60 |
| 3 | 36 71 | 45 89 | 4,5 8,9 | MED | 40 | 40 |
| 4 | >71 | >89 | >8,9 | " + " | 60 | 25 |

How to fill rinse aid

Rinse aid

This product makes dishes sparkle and helps them to dry without spotting. The dispenser is located on the inside panel of the door. When the low rinse aid indicator "H" lights, you must load rinse aid.

Loading the rinse aid

Regardless of the type of detergent dispenser installed on your appliance, you must proceed as indicated below when loading the rinse aid.

To open the dispenser, turn the "2" cap in an anti-clockwise direction and then pour in the rinse aid, making sure not to overfill. The amount of rinse aid used for each cycle can be regulated by turning the "3" dose adjuster, located beneath the "2" cap, with a screwdriver. There are 6 different settings; the normal dosage setting is 3.

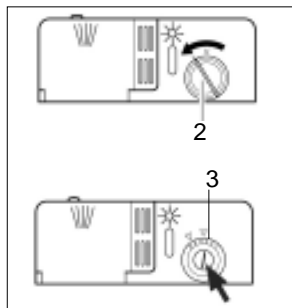
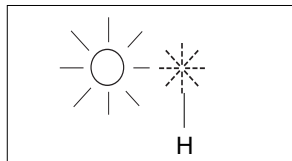

Important

Proper dosage of the rinse aid improves drying. If drops of water remain on the dishes or spotting occurs, the dosage adjuster should be turned to a higher setting. If the dishes have white streaks, turn the dosage adjuster to a lower setting.

How to fill the detergent dispenser

Detergent

Detergent specifically intended for use with dishwashers must be used. The dispenser must be refilled before the start of each wash cycle following the instructions provided in the "Programme overview". The detergent dispenser is located on the inside panel of the door.

Loading the detergent

- To open the "4" cover on the dispenser, press the "5" button.
- The detergent for the wash cycle should be poured into the "6" compartment.
- The detergent for the pre-wash cycle should be poured into the "7" compartment.
- After the detergent has been placed in the dispenser, close the cover and press down until it clicks in place.

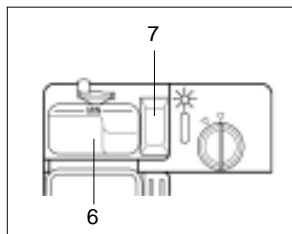
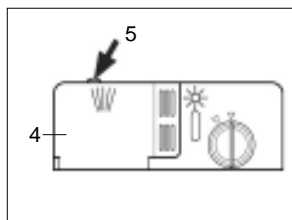

Notice:

To facilitate closing the cover, remove any excess detergent on the edges of the dispenser.

Not suitable for the dishwasher

What you should not put into the dishwasher

Cutlery and tableware manufactured in whole or part from wood. They become faded and unsightly in appearance. Furthermore, the adhesives that are used are not suitable for the temperature that occur inside the dishwasher. Delicate decorative glassware and vases, special antique or irreplaceable china. The decorative patterns on such items will not be dishwasher-proof.

Plastic objects that are not resistant to hot water, copper and pewter utensils are also not suitable. Decorative patterns printed or painted onto the surface of crockery, glasses, etc., aluminium and silver items tend to become discoloured or faded if washed in the dishwasher. Some types of glass can become opaque in appearance after they have been washed many times in a dishwasher. Highly absorbent materials, such as sponges and towels, should never be placed in the dishwasher.

Our recommendation

In future, only purchase table or kitchenware that has been confirmed as being dishwasher-proof.



Important

Dishes or cutlery that have been soiled by tobacco ash, wax, lubricating grease or paint, should not be put in the dishwasher.

Damage to glassware and other dishes

Possible causes

- type of glass or manufacturing process
- chemical composition of detergent
- water temperature and duration of dishwasher programme.

Suggested remedy

- Use glassware or porcelain dishes that have been marked 'dishwasher-proof' by the manufacturer.
- Use a mild detergent that is described as 'kind to dishes'. If necessary, seek further information from detergent manufacturers.
- Select a programme with a low temperature and a short duration as possible.
- To prevent damage, take glass and cutlery out of the dishwasher as soon as possible after the programme has ended.

Arranging crockery, glasses, etc. in the dishwasher

Before placing the dishes in the dishwasher, remove larger food particles to prevent the filter from becoming clogged, which results in reduced performance.

If the pots and pans have baked-on food that is extremely hard to remove, we recommend that they are soaked before washed. This will eliminate the need for extra wash cycles.

Pull out the rack to load the dishwasher.

How to use the lower rack

We recommend that you place the most difficult to clean items on the bottom rack: pots, pans, lids, serving dishes and bowls, as shown in the figure to the right.

It is preferable to place serving dishes and lids on the sides of the racks in order to avoid blocking the rotation of the top spray arm.

- Pots, serving bowls, etc. must always be placed face down (see fig.C) .
- Deep pots should be slanted to allow the water to flow out.
- The silverware basket can be doubled (see fig.D) so that only one section may be used when the silverware load is light. This also makes space for additional pots and pans and it can also be placed in the upper rack.
- Silverware should be placed in the silverware basket with the handles at the bottom; if the rack has side baskets, the spoons should be located individually into the appropriate slots. Especially long utensils should be placed in the horizontal position at the front of the upper rack.

Normal daily load

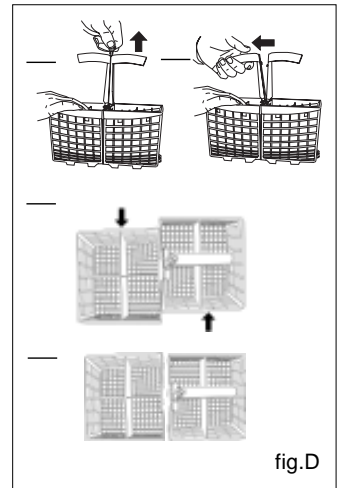
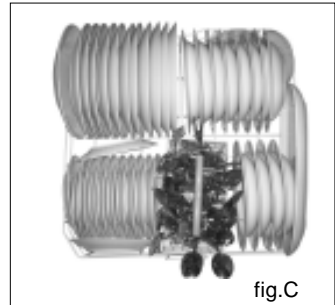

Warning

knives and other utensils with sharp points must be loaded in the basket with their points down or placed in a horizontal position.

How to use the upper rack

The upper rack is designed to hold more delicate and lighter dishware, such as glasses, cups and saucers, plates, small bowls and shallow pans (as long as they are not too dirty).

- Position the dishes and cookware so that they do not get moved by the spray of water.
- The upper rack can be adjusted for height by using the knobs located on both sides of the rack itself (see fig.E).

Adjust the upper basket to the higher level and you have more space to accommodate those taller pans and trays in the bottom basket.

Shelf

Lean tall glasses and those with long stems against the shelf - not against other items to be washed.

Place glasses, cups and small bowls on the additional cup rack. The additional cup rack can be swivelled in or out as required (see fig.F).

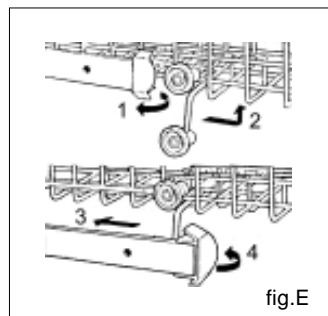

fig.E

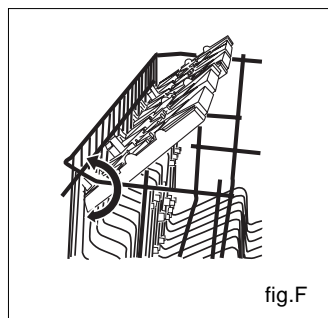







fig.F

Programme overview

| Wash programme | Type of crockery e.g. china, pots/ pans, cutlery, glasses, etc | Type of food remains | Amount of food remains | Condition of food remains | Description of cycle | Speedup Wash |
|--|--|--|------------------------|---------------------------|---|--------------|
|  Intensive Wash | Non-delicate | Soups, casseroles, sauces, potatoes, pasts, rice, eggs, roast or fried food. | a lot | stuck on hard | Pre-wash with hot water. Extended wash at 70°C. Rinses with cold water. Rinse with hot water. Drying. | — |
| | | | | | Pre-wash use cold water. Extended wash at 55°C. Rinse with cold water. Rinse with hot water. Drying. | ● |
|  Normal Wash | | | | | Pre-wash use cold water. Extended wash at 55°C. Rinse with cold water. Rinse with hot water. Drying. | — |
| | | | | | | ● |
|  Light Wash (EN50242) | | Soups, potatoes, pasta, rice, eggs, roast or fried food. | a little | loosely attached | Pre-wash use cold water. Extended wash at 50°C. Rinse with cold water. Rinse with hot water. Drying. | — |
| | | | | | | ● |
|  Glass ware | Mixed | Coffee, cakes, milk, sausage, cold drinks, salads | Very little | loosely attached | Wash at 45°C. Rinse with cold water. Hot rinse. Drying. | — |
| | | | | | | ● |
|  Rapid wash | | | | | Short wash at 40°C. Cold rinse. | — |
| | | | | | | ● |
|  Soak | | Rinse off if the dishes have been stacked for several days in the dishwasher prior to washing. | | | Short cold wash to prevent food residue from drying on the dishes . | — |
| | | | | | | ● |

| Delayed Start | Detergent | | Rinse Aid |
|---------------|---------------|---------|-----------|
| | Extended Wash | Prewash | |
| ● | 25g | 5g | ● |
| ● | 15g | 5g | ● |
| ● | 25g | 5g | ● |
| ● | 15g | 5g | ● |
| ● | 25g | 5g | ● (*) |
| ● | 20g | 5g | ● |
| ● | 15g | — | ● |
| ● | 10g | — | ● |
| ● | 15g | — | — |
| ● | 10g | — | — |
| ● | — | — | — |
| ● | — | — | — |

Laboratory measured valve in accordance with European Standard EN50242

| Duration in minutes | Energy consumption in kWh | Water consumption in litres |
|---------------------|---------------------------|-----------------------------|
| 112 | 1.62 | 18 |
| 94 | 1.48 | 16 |
| 102 | 1.24 | 15 |
| 90 | 1.15 | 14 |
| 162 | 1.05 | 14 |
| 142 | 1.00 | 13 |
| 92 | 1.12 | 12 |
| 82 | 1.10 | 10 |
| 31 | 0.40 | 9 |
| 29 | 0.30 | 8 |
| 12 | 0.02 | 3 |
| 12 | 0.02 | 3 |

* EN50242 test with rinse aid setting 5

Washing dishes

Programme selection

The most appropriate programme can be identified by comparing the type of crockery, cutlery, etc., as well as the amount and condition of food remains, with the details contained in the wash cycle table. The corresponding programme sequence, duration and consumption details are shown in the right half of the overview. For example:

Use the « normal»  programme for dishes and utensils which have plenty of food remains stuck on hard.

Earn savings

If only a small number of dishes have been loaded into the dishwasher, selecting a programme that operates at the next lowest temperature will usually be sufficient.

Programme data

The stated programme data are based on standard operating conditions. The values can vary considerably according to:

- different amounts of dishes
- temperature of mains water supply
- pressure of mains water supply
- ambient temperature
- fluctuations in mains voltage
- machine-related factors (e.g. temperature, water volume,...)

Energy and water consumption is reduced by up to 1/4 when dishes are washed in the upper basket only. The water consumption values are related to water hardness level 1.

Switching the dishwasher ON

- Turn on the tap.
- Set ON-OFF button "A" to ON. All the programme indicators "J1, J2, J3, J4, J5, J6" light.
- Press programme button "I1", programme indicator "J1" blinks and the time-remaining indicator "F" displays the time of the programme..
- If the door is closed, after 5 seconds, the programme indicator "J1" becomes to light and the dishwasher beeps one time, then the programme starts automatically.

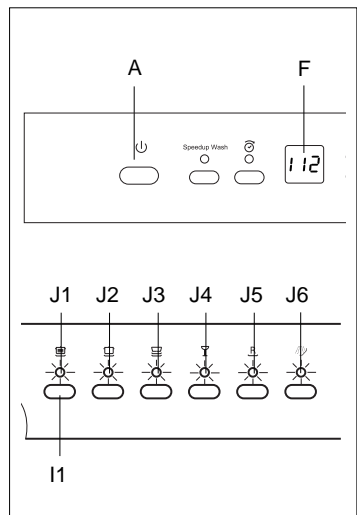

End of programme

- Six beeps will indicate that the wash cycle has finished and all the programme indicators light.

Switching the dishwasher OFF

Several minutes after the programme has ended:

- Set main switch “A” to OFF.
- Open the door .
- Turn the water tap off.
- Remove dishes, etc. when they have cooled down.

Interrupting the programme

- Open the door. Caution! There is a risk of water squirting out from inside the appliance. Do not open the door fully until spray arm has stopped rotating.
- When you open the door, the dishwasher will beep ten times every thirty seconds.
- If the appliance has already heated up or the hot water was switched ON and then the appliance door opened, leave the door ajar for several minutes and then close. Otherwise, the appliance door may open due to expansion.

Delayed start programming

You can delay the start of a programme in increments of one hour up to 12 hours.

- Switch dishwasher ON.
- Immediately press the Delayed Start button “D”, the delayed start indicator “E” blinks, the delayed start time indicator “F” changes to “1h”.
- Press the Delayed Start button “D” as many times as necessary until the numerical display shows the required delay.
- To cancel the time delay setting, pressing the Delayed Start button until the delayed start indicator “E” goes out.
- Press programme button “I” to choose the desired programme.

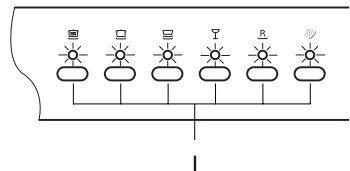
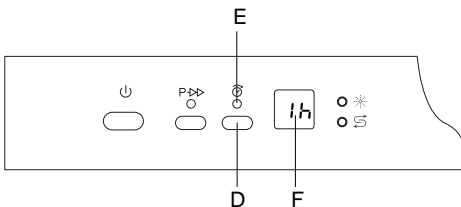

- If the the door is closed, after 5 seconds the delayed start indicator “ E ” lights , the time-remaining indicator “ F ” will blink and decrease , the programme will start until the delayed start indicator “ F ” goes out .

Cancelling or modifying a cycle

- A cycle that is underway can be modified if it has only been running for a short time. Otherwise, the detergent may have already been used, and the appliance may have already drained the wash water. If this is the case, the detergent dispenser must be refilled (see the paragraph entitled, “ Loading the detergent ”).
- To modify a cycle that is already underway, press the button“ A ” , all of the settings will be cancelled. To set a new cycle, follow the instructions contained in the paragraph entitled “Switching the dishwasher ON”.

Speedup Wash

You could save your washing time when push button “C” after choosing the programme.
(except for soak programme)

Suggestion

Use this function when there is less cutlery loading.

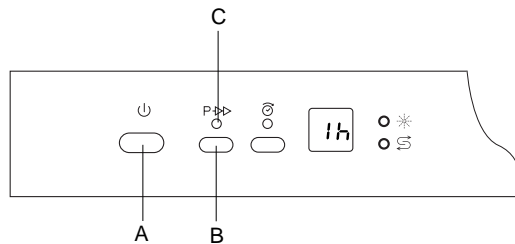

How to keep your dishwasher in shape

After Every Wash

After every wash, turn off the water supply to the appliance and leave the door slightly ajar so that moisture and odors are not trapped inside.

Remove the plug

Before cleaning or performing maintenance, always remove the plug from the socket. Do not run risks.

No solvents or Abrasive Cleaning Products

To clean the exterior and rubber parts of the dishwasher, do not use solvents or abrasive cleaning products. Rather, use only a cloth and warm soapy water.

To remove spots or stains from the surface of the interior, use a cloth dampened with water and a little white vinegar, or cleaning product made specifically for dishwashers.

Moving the Appliance

If the appliance must be moved, try to keep it in a vertical position. If absolutely necessary, it can be positioned on its back.

Seals

One of the factors that cause odors to form in the dishwasher is food that remains trapped in the seals. Periodic cleaning with a damp sponge will prevent this from occurring.

The door should not be left in the open position since this could present a tripping hazard.

When You Go on Holiday

When you go on holiday, it is recommended that you run a wash cycle with the dishwasher empty and then remove the plug from the socket, turn off the water supply and leave the door of the appliance slightly ajar. This will help the seals last longer and prevent odors from forming within the appliance.

Care and maintenance

Regular inspection and maintenance of your appliance helps to prevent problems from occurring. This saves time and aggravation. You should therefore carefully inspect the inside of your dishwasher from time to time.

Overall condition of appliance

- Check that no grease or scale has accumulated on the inside of the dishwasher.

If you discover any deposits:

- Clean the interior of the dishwasher thoroughly with a detergent solution.

Dishwasher salt

Check the LOW SALT indicator “G”. Top up with salt, if required.

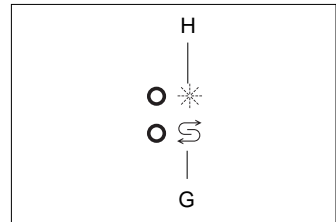

Rinse-aid

Check the LOW RINSE AID indicator “H”, on the front panel. Top up with rinse-aid, if required.

Filters

The filters “8”, “9” prevent larger particles of food in the water from reaching the pump. These particles may occasionally block the filters.

- When the appliance has finished washing, check the filters for particles of food and, if required, clean.
- After undoing the coarse micro-filter “8”, the filter unit “10” can be removed. Remove any particles of food and rinse the filters under running water.
- Insert the filter unit “9” and tighten the coarse micro-filter.

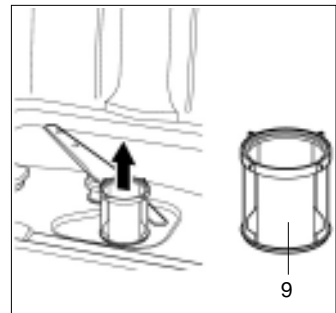
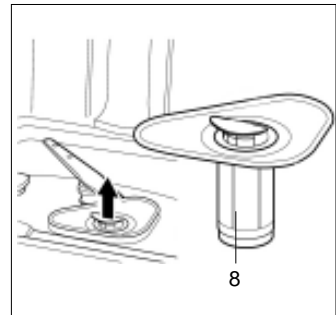

Spray arms

Lime and remnants of food in the washing water can block the nozzles in the spray arms " 10 " and " 11 " and the arm mountings.

- Inspect the nozzles in the spray arms for blocked holes due to remnants of food.
- If necessary, pull the lower arm " 11 " upwards and lift it off.
- Unscrew the upper spray arm " 10 ".
- Clean both spray arms under running water.
- Refit the spray arms. Ensure that the lower arm has locked into place and the upper one is screwed tight.

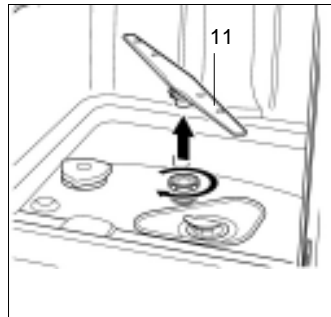
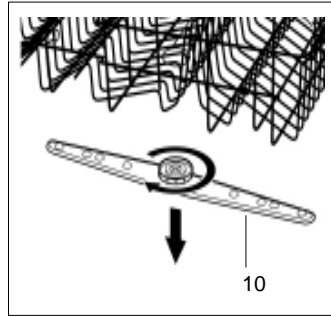

Fault finding

Resolving minor problems yourself

Experience has shown that you can resolve most problems that rise during normal daily usage yourself, without having to call out a service engineer. Not only does this save costs, but it also means that the appliance is available for use again that much sooner. The following list of common occurrences and their remedies should help you identify the causes of most problems.

Problems...

...when the appliance is switched on

Appliance does not start up

- Fault with fuse in mains electricity supply.
- Plug not inserted in wall socket.
- Appliance door not closed properly.
- Programme button has not been pressed.
- Water tap not turned on.
- Blocked strainer in water intake hose.
 - The strainer is situated in the Aquastop or supply-hose connection.



Caution

Do not forget that repairs should only be carried out by a qualified specialist. Improper repairs can lead to considerable equipment damage as well as danger to the user.

...with the appliance itself

Error display on the time-remaining indicator

When all the programme indicators “J” blink.

Have you checked whether:

- the door is closed properly.

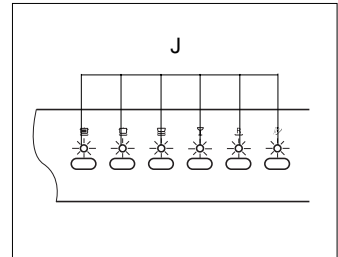

When the programme indicators “J1,J2,J3” blink.

Have you checked whether:

- the water is turned on and the hose is connected properly;
- the water supply to the house is on and has sufficient pressure;
- the water supply hose is crimped or bent;
- the filter for the water supply hose is clogged.
- the drain hose is too low.

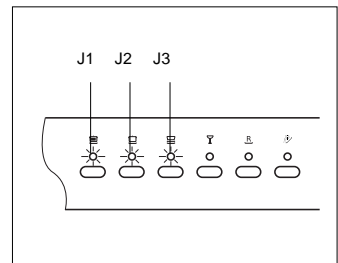

When the programme indicators “ J1,J3,J4” blink.

Have you checked whether:

- the drain hose is crimped or bent.
- the drain hose is too high.

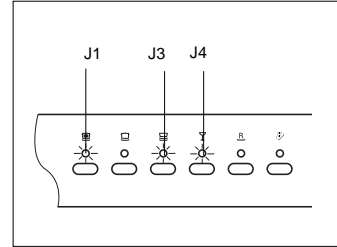

When the programme indicators “ J1,J2,J6” blink.

Have you checked whether:

- the drain hose is too low.

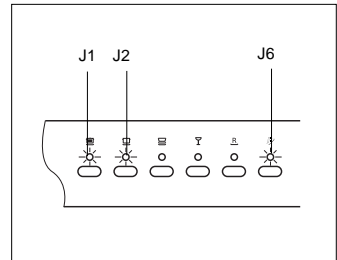

If you take all these checks and the dishwasher still does not function or your dishwasher have any other error display, you can power the dishwasher OFF, and wait a few minutes. You can power the dishwasher on, try it again , if the dishwasher still does not function and/or the problem persists, contact the nearest authorised service center and provide them with the following information:

- the nature of the problem.
- the model type number (Mod...) And the serial number (S/N...), which are indicated on the plate located on the side of the inner part of the door.

Lower spray arm rotates with difficulty

- Spray arm is blocked by small items or food remains.

Lid in detergent compartment cannot be closed

- Detergent compartment has been overfilled.
- Mechanism is clogged with remnants of detergent.

Indicator lamps do not extinguish after washing has finished

- Main switch is still set to ON.

Remnants of detergent stuck inside dispenser

- Compartment was damp when it was filled up with detergent. Compartment must be dry before detergent is added.

Water remains inside appliance after programme has ended

- Blockage or kind in drainage hose.
- Pump is jammed.
- Filters are blocked.
- The programme is still running. Wait for the programme to end .

...during washing

Unusual amount of foam is creased

- Normal washing up liquid has been poured into the rinse-aid container.
- Remove any spilled rinse aid with a cloth as it could otherwise lead to excessive foaming during the next washing cycle.

Appliance stops suddenly while washing is taking place

- Cut off electricity supply to appliance.
- Water supply has been interrupted.

Knocking sound can be heard while washing is taking place

- A spray arm is knocking against the dishes inside the appliance.

Rattling sound can be heard while washing is taking place

- Crockery has not been stacked properly inside the appliance.

Knocking sound coming from inlet valves

- This is caused by the way the water pipes have been laid and it has no effect upon the way the appliance functions. There is no remedy for this.

...with the dishes,cutlery, etc.

Remnants of food are stuck to the dishes, cutlery,etc.

- Dishwasher was not loaded properly. Jets of water could not reach all parts of the dishes, ect.
- Too many items in the rack.
- Items in the rack were touching each other.
- Not enough detergent was added to dispenser.
- Selected wash programme was not intensive enough.
- Rotation of spray arm was obstructed by dishes, etc.
- N ozzles in spray arm are blokcked by remnants of food.
- Filters are blocked.
- Filters have been incorrectly fitted.
- Waste-water pump is jammed.

Plastic items are discoloured

- Not enough detergent was added to dispenser.
- Detergent has insufficient bleaching properties. Use a detergent containing a chemical bleaching agent.

White stains are left on crockery, glasses have a milky appearance

- Not enough detergent was added to dispenser compartment.
- Amount of rinse-aid was set too low.
- Although water is quite hard, no salt has been put in appliance.
- Water softener was set too low.
- Lid on salt container is not screwed tight.
- If you used a phosphate-free detergent , try a detergent containing phosphates and compare results.

Dishes,cutlery,etc.have not been dried

- Selected programme did not include drying function.
- Amount of rinse-aid was set too low.
- Items were removed from dishwasher too soon.

Glasses have a dull appearance

- Amount of rinse-aid was set too low.

Tea stains or traces of lipstick have not been completely removed

- Detergent does not have a sufficient bleaching effect.
- Washing temperature was set too low.

Traces of rust on cutlery

- Cutlery is not sufficiently rustproof.
- Salt content in washing water is too high.
 - Lid on salt container is not screwed tight.
 - Too much salt was spilt while filling container.

Glasses become clouded and discoloured; coating cannot be wiped off

- Unsuitable detergent was used.
- Glasses are not dishwasher-proof.

Smears left behind on glasses and cutlery; glasses have acquired a metallic appearance

- Amount of rinse-aid set too high.

Technical data

| | |
|----------------------------------|-----------------------------------|
| Width | 60 cm |
| Depth | 60 cm |
| Height | 85 cm |
| Capacity | 12 standard place settings |
| Mains water pressure | 0.03-0.6MPa |
| Power voltage | 220-240V~ 50Hz |
| Maximum current intensity | 10A |
| Total absorbed power | 1950W |

Important information

Notes on waste disposal

Old appliances still have some residual value. An environment-friendly method of disposal will ensure that valuable raw materials can be recovered and used again.

When an appliance has reached the end of its working life, unplug it from the mains. Cut through the mains cable and dispose of it together with the plug.

Destroy the door locking mechanism. This will ensure that children at play cannot become locked inside and are not exposed to the risk of suffocation.

Your new appliance was protected by suitable packaging while it was on its way to you. All materials used for this purpose are environment-friendly and can be recycled. Please make a contribution to protecting the environment by disposing of the packaging appropriately.

Do not allow children to play with any parts of the packaging. There is a risk of suffocation by the cardboard boxes and the plastic wrapping.

Up-to-date information concerning options for disposal can be obtained from your retailer or local municipal administration.

General information

- Measures must be taken to ensure that built-under and built-in units that are subsequently re-sited as free-standing appliances cannot topple over. This can be achieved by bolting the dishwasher to the wall or fitting it under a continuous work surface which is screwed to the adjacent cupboards.

Information on comparability tests implemented in compliance with EN 50242

Appliance loaded in accordance with standard specifications.

Example of loaded dishwasher: See Fig 1 and 2

Capacity: 12 place settings

Comparability programme: Light wash

Rinse-aid setting: 5

Detergent: 25+5g

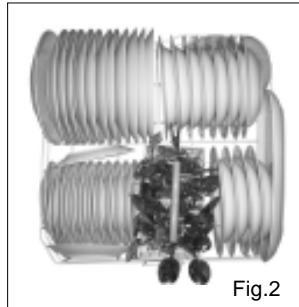
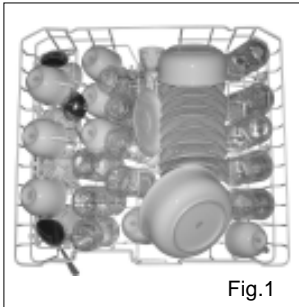

Height-adjustable top-basket must be inserted in the uppermost position.

If the comparability tests do not comply fully with EN 50242, e.g., degree of soiling, type of dishes and cutlery, etc., contact the appliance manufacturer before starting the test.

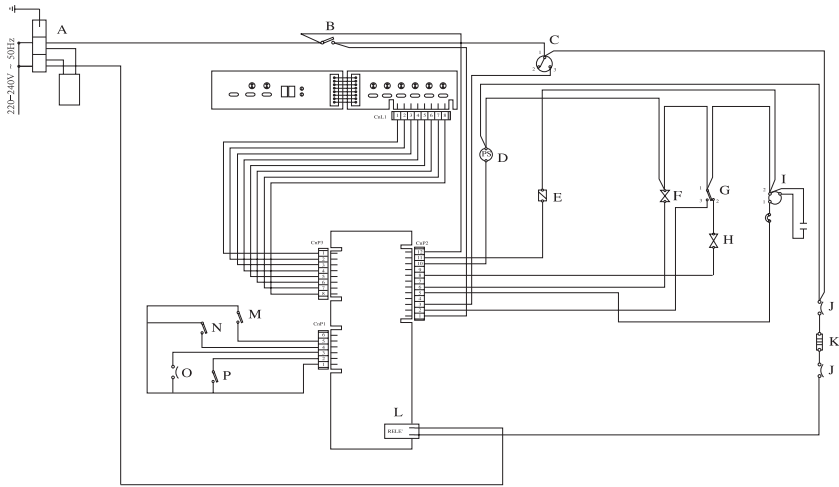

A: Wiring box

B: Door switch

C: Water level switch

D: Drain pump motor

E: Dispenser

F: Softener valve

G: Overflow switch

H: Inlet valve

I: Washing pump motor

J: Temperature limiter

K: Heater

L: Relay

M: Low salt switch

N: Low rinse aid switch

O: Temperature sensor

P: Flowmeter



The symbol  on the product or on its packaging indicates that this product may not be treated as household waste. Instead it shall be handed over to the applicable collection point for the recycling of electrical and electronic equipment. By ensuring this product is disposed of correctly, you will help prevent potential negative consequences for the environment and human health, which could otherwise be caused by inappropriate waste handling of this product.

For more detailed information about recycling of this product, please contact your local city office, your household waste disposal service or the shop where you purchased the product.