

Panasonic

2.4GHz Cordless Answering System

Operating Instructions

Model No. **KX-TG2584S**

Pulse-or-tone dialing capability

Preparation

Cordless Telephone

Answering System

Useful Information



Caller ID Compatible

PLEASE READ BEFORE USE AND SAVE.

Charge the battery for about 15 hours before initial use.

Panasonic World Wide Web address: <http://www.panasonic.com>
for customers in the USA or Puerto Rico

Before Initial Use

Please read **IMPORTANT SAFETY INSTRUCTIONS** on page 87 before use. Read and understand all instructions.

Thank you for purchasing your new Panasonic cordless telephone.

Caller ID and Call Waiting Service, where available, are telephone company services. After subscribing to Caller ID, this phone will display a caller's name and phone number. Call Waiting Caller ID, which displays a second caller's name and phone number while the user is on another call, requires a subscription to both Caller ID and Call Waiting.

Attach your purchase receipt here.

For your future reference

Serial No. _____

Date of purchase _____

(found on the bottom of the unit)

Name and address of dealer _____

Accessories (included) For extra orders, call 1-800-332-5368.

- AC Adaptor (p. 10)
Order No. PQLV10Z

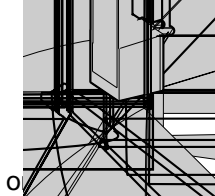

one

- Telephone Line Cord (p. 10)
Order No. PQJA10075Z

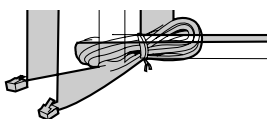

one

- Handset (p. 10)
Order No. PQJXF0621Z

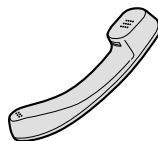

one

- Handset Cord (p. 10)
Order No. PFJA04C001Z

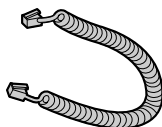

one

- Belt Clip (p. 76)
Order No. PQKE10127Z3

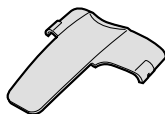

one

- Charger Unit (p. 11)
Charger Order No. PQLV30016ZS
AC Adaptor Order No. KX-TCA1-G (KX-TCA1)



one

For Best Performance

Battery Charge

A rechargeable Ni-Cd battery powers the cordless handset. Charge the battery for about **15 hours** before initial use (p. 11).

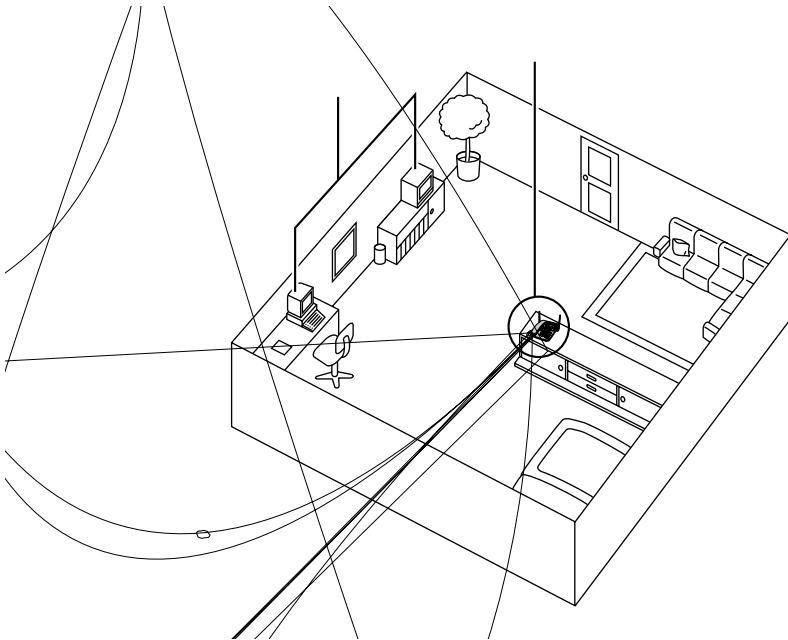

Contents

Preparation

Location of Controls	6
Displays	9
Settings	10
Connections	10
Battery Charge	11
Date and Time Base Unit	13
Dialing Mode Cordless Handset	15
Line Mode Cordless Handset	16
Programmable Functions	17
Auto Talk Feature Cordless Handset	19
Ringer Volume Cordless Handset Base Unit	20
LCD Contrast Cordless Handset Base Unit	21
Preparing the Answering System	23
Greeting Message Base Unit	23
Caller's Recording Time Base Unit	26
Number of Rings Base Unit	27

Cordless Telephone

Making Calls Cordless Handset Base Unit	28
Answering Calls Cordless Handset Base Unit	33
Caller ID Service	34
Using the Caller List	35
Viewing the Caller List Cordless Handset Base Unit	35
Calling Back from the Caller List Cordless Handset Base Unit	36
Editing the Caller's Phone Number Cordless Handset Base Unit	37
The Caller ID Number Auto Edit Feature Cordless Handset	39
Storing Caller List Information in the Directory Cordless Handset	41
Erasing Caller List Information Cordless Handset Base Unit	42
Directory	44
Storing Names and Numbers Cordless Handset	44
Entering Names and Symbols Cordless Handset	46
Finding Stored Items Cordless Handset Base Unit	47
Dialing Cordless Handset Base Unit	49
Editing Cordless Handset	50
Erasing Cordless Handset Base Unit	51
One-Touch Dialer	52
Storing Phone Numbers in Memory Base Unit	52
Dialing Base Unit	53
Intercom Cordless Handset Base Unit	54
Transferring a Call Using the Intercom Cordless Handset Base Unit	55
Conference Cordless Handset Base Unit	56

Special Features	57
Temporary Tone Dialing (For Rotary or Pulse Service Users)	
Cordless Handset Base Unit	57
Muting Your Conversation Cordless Handset Base Unit	57
For Call Waiting Service Users Cordless Handset Base Unit	58
How to Use the PAUSE Button	
(For PBX Line/Long Distance Calls) Cordless Handset Base Unit ..	58
FLASH Button Cordless Handset Base Unit	59
Security Code Setting Cordless Handset & Base Unit	60

Answering System

Automatic Answering Operation	61
Setting the Unit to Answer Calls Base Unit	61
Call Monitoring Feature Base Unit	62
Listening to Messages Base Unit	63
Erasing Messages Base Unit	65
Remote Operation from a Touch Tone Phone	66
Remote Code Base Unit	67
Voice Menu	68
Direct Remote Operation	70
Remote Operation with the Cordless Handset Cordless Handset ..	72

Useful Information

Wall Mounting	74
Belt Clip	76
Optional Headset	76
Battery Replacement	77
Adding Another Phone	78
If the Following Appear...	79
Troubleshooting	81
Important Safety Instructions	87
FCC and Other Information	89
Specifications	92
Warranty	93
Index	95

Important:

- Cordless Handset** : Perform with the cordless handset.
- Base Unit** : Perform with the base unit.
- Cordless Handset Base Unit** : Perform with the cordless handset and the base unit separately.
- Cordless Handset & Base Unit** : Perform with both the cordless handset and base unit together.

Location of Controls

Base unit



► Location of Controls

Cordless handset

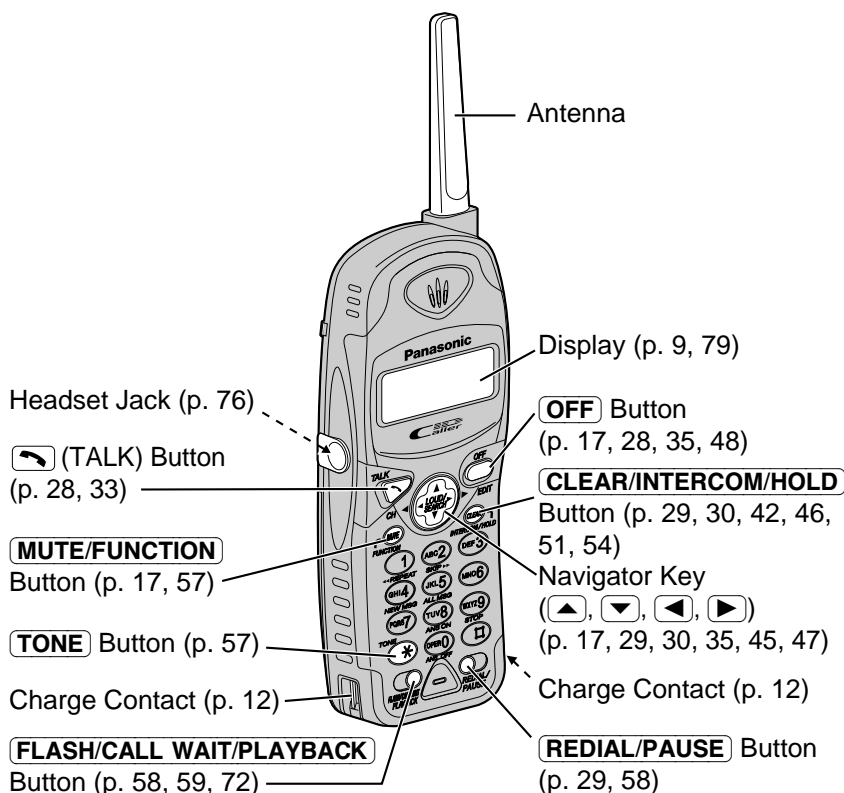

How to use the Navigator key

This key has four active areas that are indicated by arrows.



- Pressing the up and down arrows allows you to enter the Caller List and scroll through the function menu, the Caller List and the directory list. They are also used to adjust the cordless handset receiver volume.
- Pressing the right and left arrows allows you to enter the directory list and move the cursor when entering directory items.
- The right arrow is used to select or confirm your menu choices and to edit a phone number of the Caller List into one of 3 patterns. The left arrow is used to select a clearer channel.

Throughout this Operating Instructions, the navigator key is indicated by the arrows ▼, ▲, ◀ or ▶.

Charger unit

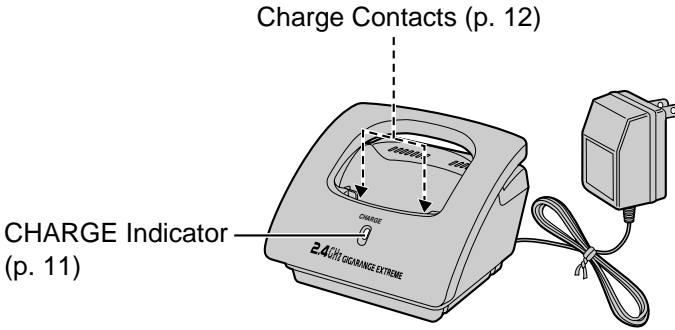

Displays

Cordless handset

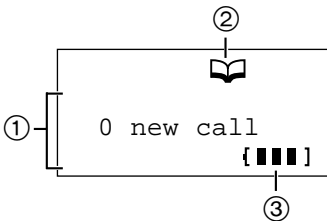

- ① The display shows the dialed number, call status, programming options and directory items etc. If you subscribe to a Caller ID service, caller information will be displayed (p. 34). The number of new calls will also be displayed.

- ② The directory icon displays when storing or viewing the directory items (p. 44, 47).
- ③ The battery icon indicates the battery strength (p. 11).

Base unit

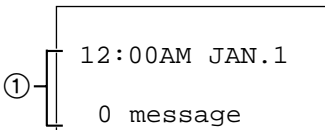

- ① The time and date and the number of incoming messages are displayed while the unit is not in use. The display shows the dialed number, call status, programming options and directory items etc.

If you subscribe to a Caller ID service, caller information will be displayed (p. 34). The number of new calls will also be displayed.

Settings

Connections

Base unit

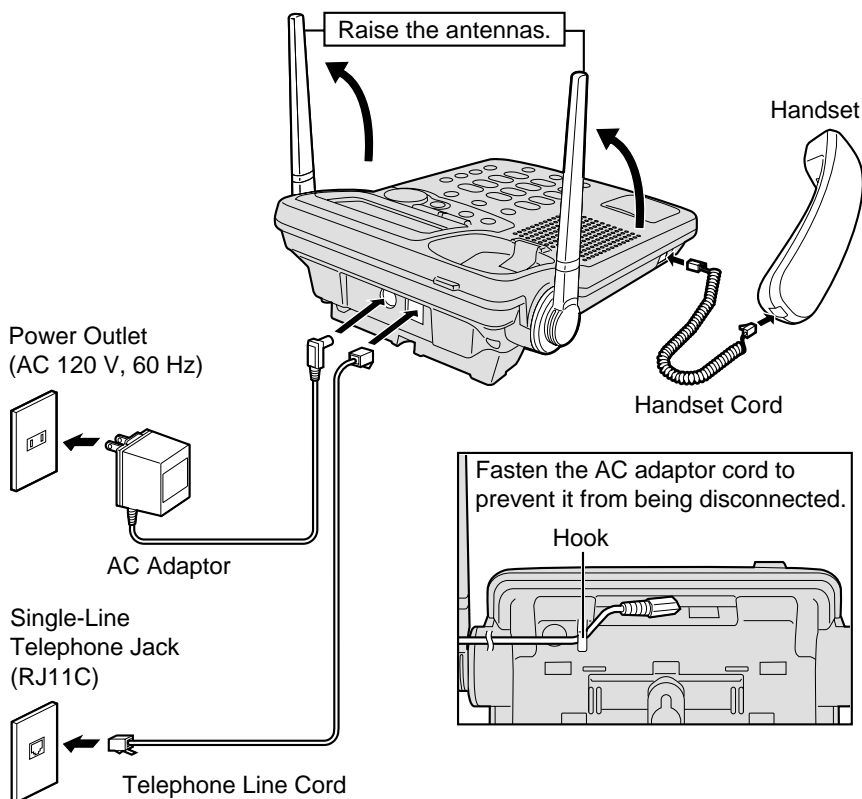

- USE ONLY WITH Panasonic AC ADAPTOR PQLV10 (Order No. PQLV10Z).
- The AC adaptor must remain connected at all times. (It is normal for the adaptor to feel warm during use.)
- Use only a Panasonic Handset for the KX-TG2584S.
- To connect a standard telephone on the same line, see page 78.
- If your unit is connected to a PBX which does not support Caller ID services, you cannot access those services.



Charger unit

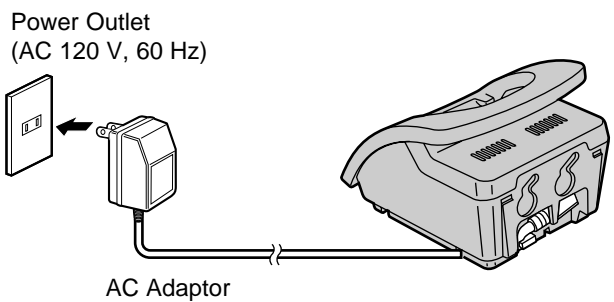

- USE ONLY WITH Panasonic AC ADAPTOR KX-TCA1 (Order No. KX-TCA1-G).
- The AC adaptor must remain connected at all times. (It is normal for the adaptor to feel warm during use.)

Battery Charge

Place the cordless handset on the charger and charge for about **15 hours** before initial use.

- Make sure the cordless handset faces forward as shown.
- The CHARGE indicator lights and a beep sounds.
- Charge time may be longer than 15 hours depending on circumstance noise condition.

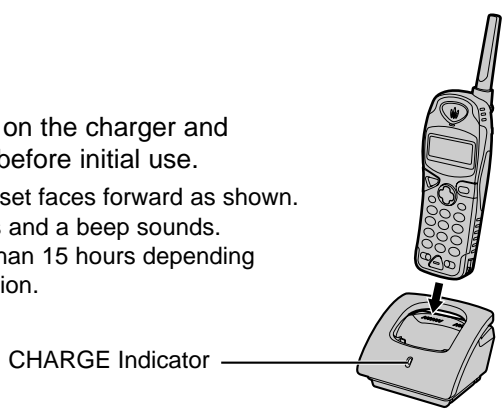

Battery strength

You can check the battery strength on the cordless handset display. The battery strength is as shown in the chart below.

Display prompt	Battery strength
{ █ █ █ █ }	Fully charged
{ █ █ █ }	Medium
{ █ █ }	Low
⚡ { █ █ } ⚡ (flashing)	Needs to be recharged.

► Settings

Recharge

Recharge the battery when:

- “Recharge battery” is displayed,
- “{ ■}” flashes on the display, or
- the cordless handset beeps intermittently while it is in use.

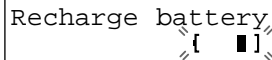

Recharge battery
{ ■}

- If you DO NOT recharge the cordless handset battery for more than 15 minutes, the display will continually indicate “Recharge battery” and/or “{ ■}” will continue to flash when the cordless handset is lifted off the charger.

Battery information

After your Panasonic battery is fully charged (p. 11):

Operation		Approx. battery life
While in use (TALK)	near the base unit*	Up to about 4.5 hours
	away from the base unit	Up to about 3.5 hours
While not in use (Standby)		Up to about 11 days

*Within about 10 feet (3 m)

- Battery life may be shortened depending on usage conditions, such as viewing the Caller ID Caller List or directory list, and ambient temperature.
- Clean the charge contacts of the cordless handset and the charger with a soft, dry cloth once a month. Clean more often if the unit is subject to grease, dust or high humidity.** Otherwise the battery may not charge properly.
- If the battery is fully charged, you do not have to place the cordless handset on the charger until “Recharge battery” is displayed and/or “{ ■}” flashes. This will maximize the battery life.
- The battery cannot be overcharged.



Date and Time Base Unit

Voice Day/Time Stamp: During playback, a synthesized voice will announce the day and time that each message was recorded.

Make sure the base unit and cordless handset are not being used.

1 Press **FUNCTION/EDIT**.

▶Date and time
Save DIRECT#
▼▲ ▶=Yes

2 Press **▶** (Yes key) at "Date and time".

Date:2002.01.01
0-9=Date ◀▶
▼=Next

3 Enter the current date (year, month, and day) using 4-digit numbers.
(Ex. To set Apr. 15, 2002, enter "2002" and "0415".)

Date:2002.04.15
0-9=Date ◀▶
▼=Next

4 Press **▼** (Next key).

Time:12:00AM
0-9=Time ◀▶
*=AM/PM ▼=Next

5 Enter the current time (hour and minute) using a 4-digit number.
(Ex. To set 9:30, enter "0930".)

Time:09:30AM
0-9=Time ◀▶
*=AM/PM ▼=Next

6 Select "AM" or "PM" by pressing *****.

Time:09:30PM
0-9=Time ◀▶
*=AM/PM ▼=Next

7 Press **▼** (Next key).

Date:2002.04.15
Time:09:30PM
▲=Edit ▶=Save

8 Press **▶** (Save key).
•A beep sounds.
•The clock starts working.
•If 3 beeps sound, the setting is not correct. Start again from step 3.

Date:2002.04.15
Time:09:30PM

- You can exit the programming mode any time by pressing **EXIT/STOP**.
- In step 5, you cannot enter numbers greater than 12. **Do not use military time.** (To set 13:00 hours, enter "0100", and select "PM" by pressing *****.)
- If you enter a wrong number in step 3 or step 5, press **◀** or **▶** to move the cursor to the incorrect number. Enter the correct number.

► Settings

If a power failure occurs, the time/date flashes on the base unit display. Adjust the date/time.

For Caller ID service users (p. 34)

- The Caller ID information will reset the clock after the first ring if the adjusted time and/or date is incorrect.
- If the time has not previously been set, the Caller ID information will not adjust the clock.
- The Caller ID information will automatically adjust the clock for daylight saving time.



Dialing Mode Cordless Handset

You can program the dialing mode **using the cordless handset near the base unit**. If you have touch tone service, set to "Tone". If rotary or pulse service is used, set to "Pulse". Your phone comes from the factory set to "Tone".

Make sure the base unit and cordless handset are not being used.

1 Press **MUTE/FUNCTION**.

```
▶Save directory
  Ringer volume
▼▲                               ▶=Yes
```

2 Scroll to "Program" by pressing ▼ or ▲.

```
  LCD contrast
▶Program
▼▲                               ▶=Yes
```

3 Press ▶ (Yes key).

```
▶Set flash time
  Set line mode
▼▲                               ▶=Yes
```

4 Scroll to "Set dial mode" by pressing ▼ or ▲.

```
▶Set dial mode
  Auto talk
▼▲                               ▶=Yes
```

5 Press ▶ (Yes key).

```
  Dial mode
                               :Tone
▼▲                               ▶=Save
```

6 Select "Pulse" or "Tone" by pressing ▼ or ▲.

```
  Dial mode
                               :Pulse
▼▲                               ▶=Save
```

7 Press ▶ (Save key).

- A beep sounds.
- To exit the programming mode, press **OFF**.

```
  Dial mode
                               :Pulse
```

•You can exit the programming mode any time by pressing **OFF**.

► Settings

Line Mode Cordless Handset

You can program the line mode **using the cordless handset near the base unit**. If the line is connected to a low voltage system such as a PBX, set to "B". Otherwise the Call Waiting Caller ID Feature may not be used (p. 58). Your phone comes from the factory set to "A".

Make sure the base unit and cordless handset are not being used.

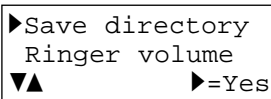
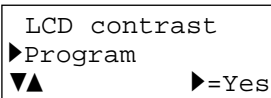
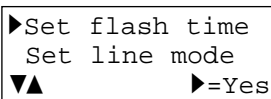
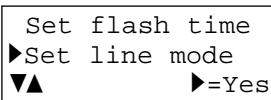
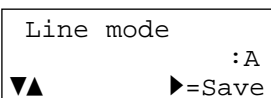
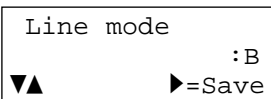
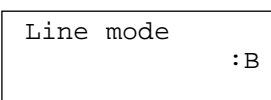
- 1 Press **MUTE/FUNCTION**.

- 2 Scroll to "Program" by pressing **▼** or **▲**.

- 3 Press **▶** (Yes key).

- 4 Scroll to "Set line mode" by pressing **▼** or **▲**.

- 5 Press **▶** (Yes key).

- 6 Select "B" or "A" by pressing **▼** or **▲**.

- 7 Press **▶** (Save key).
 - A beep sounds.
 - To exit the programming mode, press **OFF**.

• You can exit the programming mode any time by pressing **OFF**.

Programmable Functions



Cordless Handset

You can program the following function items **using the cordless handset near the base unit**. The display shows the programming instructions. See the corresponding pages for function details. **Make sure the base unit and cordless handset are not being used.**

Press **MUTE/FUNCTION** on the cordless handset.



<Function menu>*

- ▶ Save directory..... To store an item in the directory (p. 44).
- Ringer volume..... To select the ringer volume (p. 20).
- LCD contrast..... To select the LCD contrast of the cordless handset (p. 21).
- Program

Scroll to "Program" by pressing or , and press (Yes key).

<Function menu>*

- ▶ Set flash time..... To select the flash time (p. 59).
- Set line mode..... To select the line mode (p. 16).
- Set dial mode..... To select the dial mode (p. 15).
- Auto talk..... To set the Auto Talk feature (p. 19).
- Caller ID edit..... To set the Caller ID Number Auto Edit feature (p. 39).

During programming

*To select a desired function item, scroll through the items by pressing or . Then press (Yes key) to go to the next step.

- You can exit the programming mode any time by pressing **OFF**.
- If the cordless handset has lost communication with the base unit, 3 beeps sound and "No link to base. Walk closer to base & try again" is displayed.

► Programmable Functions

Base Unit

You can program the following function items **using the base unit**. The display shows the programming instructions. See the corresponding pages for function details.

Make sure the base unit and cordless handset are not being used.

Press **FUNCTION/EDIT** on the base unit.



<Function menu>*

- Date and time..... To adjust the date and time (p. 13).
- Save DIRECT#..... To store the phone numbers in the DIRECT buttons (p. 52).
- LCD contrast..... To select the LCD contrast of the base unit (p. 22).
- Set answering

Scroll to "Set answering" by pressing ▼ or ▲, and press ► (Yes key).

<Function menu>*

- Greeting record..... To record the greeting message (p. 23).
- Greeting check..... To check the recorded greeting message (p. 25).
- Remote code..... To set the remote code (p. 67).
- Number of rings..... To select the number of rings (p. 27).
- Recording time..... To select the caller's recording time (p. 26).
- Call monitoring..... To set the call monitoring (p. 62).

During programming

*To select a desired function item, scroll through the items by pressing ▼ or ▲. Then press ► (Yes key) to go to the next step.

•You can exit the programming mode any time by pressing **EXIT/STOP**.



Auto Talk Feature Cordless Handset

The Auto Talk feature allows you to answer a call by lifting the cordless handset off the charger without pressing . If you want to use this feature, turn the feature ON by programming. Your phone comes from the factory set to OFF.

Make sure the base unit and cordless handset are not being used.

1 Press MUTE/FUNCTION.

▶Save directory
 Ringer volume
 ▼▲ ▶=Yes

2 Scroll to "Program" by pressing or .

LCD contrast
 ▶Program
 ▼▲ ▶=Yes

3 Press (Yes key).

▶Set flash time
 Set line mode
 ▼▲ ▶=Yes

4 Scroll to "Auto talk" by pressing or .

Set dial mode
 ▶Auto talk
 ▼▲ ▶=Yes

5 Press (Yes key).

Auto talk
 :Off
 ▼▲ ▶=Save

6 Select "On" or "Off" by pressing or .

Auto talk
 :On
 ▼▲ ▶=Save

7 Press (Save key).

- A beep sounds.
- To exit the programming mode, press OFF.

Auto talk
 :On

- You can exit the programming mode any time by pressing OFF.
- In order to view Caller ID information after you lift the cordless handset off the charger to answer a call, leave the Auto Talk feature OFF.

► Programmable Functions

Ringer Volume

You can program the cordless handset and base unit ringer volumes to HIGH, LOW or OFF. If set to OFF, the cordless handset and base unit will not ring. Your phone comes from the factory set to HIGH.

Make sure the base unit and cordless handset are not being used.

Cordless Handset

- 1 Press **MUTE/FUNCTION**.
- 2 Scroll to “Ringer volume” by pressing **▼** or **▲**.
- 3 Press **▶** (Yes key).
 - The current setting is displayed.
- 4 Select the desired volume by pressing **▼** or **▲**.
 - Each time you press **▼** or **▲**, the volume will change and ring.
 - If you set to OFF, the unit will not ring.
- 5 Press **▶** (Save key).
 - A beep sounds.

▶Save directory
Ringer volume
▼▲ ▶=Yes

Save directory
▶Ringer volume
▼▲ ▶=Yes

HIGH
Ringer
Low ■■■■■■ High
▼▲ ▶=Save
▼ ↓ ↑ ▲

LOW
Ringer
Low ■■ High
▼▲ ▶=Save
▼ ↓ ↑ ▲

OFF
Ringer off
▼▲ ▶=Save

- You can exit the programming mode any time by pressing **OFF**.
- When you replace the battery, the selected ringer volume setting will return to the factory set (HIGH). Reprogram if necessary.

Base Unit

- To select HIGH (preset) or LOW**, press **RINGER**.
Each time you press the button, the ringer volume will change and ring.
- To turn the ringer OFF**, press and hold **RINGER** until 2 beeps sound.
“Ringer off” is displayed.
- To turn the ringer ON**, press **RINGER**.
The ringer will sound at the HIGH level.



LCD Contrast

You can program the cordless handset and base unit LCD contrast (5 levels). To make the displays clearer, set to high level. Your phone comes from the factory set to level 3.

Make sure the base unit and cordless handset are not being used.

Cordless Handset

1 Press **MUTE/FUNCTION**.

```
▶Save directory
  Ringer volume
▼▲                ▶=Yes
```

2 Scroll to "LCD contrast" by pressing ▼ or ▲.

```
▶LCD contrast
  Program
▼▲                ▶=Yes
```

3 Press ▶ (Yes key).
•The current setting is displayed.

```
LCD contrast
Low ■■■ High
▼▲                ▶=Save
```

4 Select the desired contrast by pressing ▼ or ▲.
•Each time you press ▼ or ▲, the LCD contrast will change.

```
LCD contrast
Low ■ High
▼▲                ▶=Save
```

5 Press ▶ (Save key).
•A beep sounds.
•To exit the programming mode, press **OFF**.

```
LCD contrast
Low ■ High
```

•You can exit the programming mode any time by pressing **OFF**.

► Programmable Functions

Base Unit

1 Press **FUNCTION/EDIT**.

```
►Date and time
  Save DIRECT#
▼▲                ►=Yes
```

2 Scroll to "LCD contrast" by pressing ▼ or ▲.

```
►LCD contrast
  Set answering
▼▲                ►=Yes
```

3 Press ► (Yes key).
•The current setting is displayed.

```
  LCD contrast
  Low ████      High
▼▲                ►=Save
```

4 Select the desired contrast by pressing ▼ or ▲.
•Each time you press ▼ or ▲, the LCD contrast will change.

```
  LCD contrast
  Low ██       High
▼▲                ►=Save
```

5 Press ► (Save key).
•A beep sounds.
•To exit the programming mode, press **EXIT/STOP**.

```
  LCD contrast
  Low █       High
```

•You can exit the programming mode any time by pressing **EXIT/STOP**.

Preparing the Answering System

Greeting Message Base Unit

You can record a personal greeting message of **up to 2 minutes**. If a greeting message is not recorded, one of two pre-recorded greetings will be played when a call is received (p. 25).

All messages (greeting, incoming, etc.) are stored in digital memory (p. 25). The **total recording time is about 15 minutes**.

We recommend you record a **brief greeting message** (see sample on the next page) in order to leave more time for recording new messages.

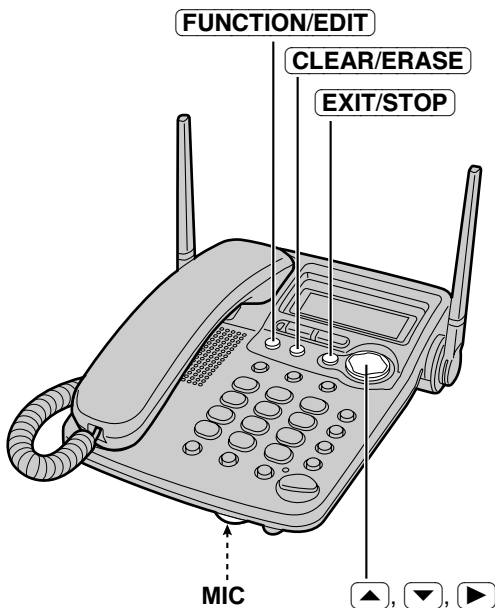

To record a greeting message

1 Press **FUNCTION/EDIT**.

▶Date and time
Save DIRECT#
▼▲ ▶=Yes

2 Scroll to "Set answering" by pressing ▼ or ▲.

LCD contrast
▶Set answering
▼▲ ▶=Yes

(Continued )

► Preparing the Answering System

3 Press  (Yes key).

►Greeting record
Greeting check
▼▲ ►=Yes

4 Press  (Yes key) at “Greeting record”.

- “Record greeting after the beep” is heard.
- A long beep sounds.

Greeting record
00-00
►=End

5 Talk clearly, about 20 cm (8 inches) away from the **MIC** (microphone).

- The base unit display shows the elapsed recording time.
- If you record for over 2 minutes, the unit will automatically stop recording and play back the recorded greeting.

Greeting record
00-30
►=End

6 When finished, press  (End key).

- The unit will automatically play back the recorded greeting.
- You can also finish recording by pressing **EXIT/STOP**.
- To exit the programming mode, press **EXIT/STOP**.
- To change the message, start again from step 4.

Greeting record
00-30

To adjust the speaker volume:

9 levels (0–8) are available while using the answering system.

To increase, press .

To decrease, press .

Greeting message sample

“Hello, this is (your name and/or number). Sorry I cannot take your call. Please leave a message after the beep. Thank you.”



To check the recorded greeting message

1 Press **FUNCTION/EDIT**.

▶Date and time
Save DIRECT#
▼▲ ▶=Yes

2 Scroll to “Set answering” by pressing ▼ or ▲.

LCD contrast
▶Set answering
▼▲ ▶=Yes

3 Press ▶ (Yes key).

▶Greeting record
Greeting check
▼▲ ▶=Yes

4 Scroll to “Greeting check” by pressing ▼ or ▲.

Greeting record
▶Greeting check
▼▲ ▶=Yes

5 Press ▶ (Yes key).
•The recorded message will start to being played.

Greeting check
00-00

To erase the recorded greeting message

Press **CLEAR/ERASE** while the message is being played.

- The unit will answer a call with a pre-recorded greeting.

Pre-recorded greeting message

If you do not record a greeting message (p. 23), one of two messages will be played when a call is received, depending on the caller’s recording time (p. 26).

- A pre-recorded greeting will be played as follows:

- When the recording time is set to “1 minute”, “2 minutes” or “3 minutes”:

“Hello, we are not available now. Please leave your name and phone number after the beep. We will return your call.”

- When the recording time is set to “Greeting only”:

“Hello, we are not available now. Please call again. Thank you for your call.”

Flash Memory Message Backup

Messages are stored on a “flash memory” IC chip and will not be affected by power failures. All messages are saved until you erase them.

► Preparing the Answering System

Caller's Recording Time **Base Unit**

You can select "1 minute", "2 minutes", "3 minutes" or "Greeting only" for the caller's recording time. Your phone comes from the factory set to "3 minutes".

Make sure the base unit and cordless handset are not being used.

1 Press **FUNCTION/EDIT**.

►Date and time
Save DIRECT#
▼▲ ▶=Yes

2 Scroll to "Set answering" by pressing ▼ or ▲.

LCD contrast
►Set answering
▼▲ ▶=Yes

3 Press ▶ (Yes key).

►Greeting record
Greeting check
▼▲ ▶=Yes

4 Scroll to "Recording time" by pressing ▼ or ▲.

►Recording time
Call monitoring
▼▲ ▶=Yes

5 Press ▶ (Yes key).
•The current setting is displayed.

Recording time
:3min
▼▲ ▶=Save

6 Select the recording time by pressing ▼ or ▲.

- You can also select the recording time by pressing dialing buttons **1** (1 minute), **2** (2 minutes), **3** (3 minutes) or **0** (Greeting only).

Recording time
:2min
▼▲ ▶=Save

7 Press ▶ (Save key).
•A beep sounds.
•To exit the programming mode, press **EXIT/STOP**.

Recording time
:2min

- You can exit the programming mode any time by pressing **EXIT/STOP**.

If you select "Greeting only", the unit will answer a call with the greeting message, and then hang up. The unit will not record any incoming messages. The base unit display will show "Greeting only" instead of the number of messages.

Number of Rings Base Unit

You can select the number of times the unit rings before the answering system answers a call, from “2” to “7” or “Toll saver”*.

Your phone comes from the factory set to “4”.

Make sure the base unit and cordless handset are not being used.

1 Press **FUNCTION/EDIT**.

```
▶Date and time
  Save DIRECT#
▼▲                ▶=Yes
```

2 Scroll to “Set answering” by pressing **▼** or **▲**.

```
LCD contrast
▶Set answering
▼▲                ▶=Yes
```

3 Press **▶** (Yes key).

```
▶Greeting record
  Greeting check
▼▲                ▶=Yes
```

4 Scroll to “Number of rings” by pressing **▼** or **▲**.

```
Remote code
▶Number of rings
▼▲                ▶=Yes
```

5 Press **▶** (Yes key).
•The current setting is displayed.

```
Number of rings
      : 4
▼▲                ▶=Save
```

6 Select the number of rings by pressing **▼** or **▲**.

- You can also select the number of rings by pressing dialing buttons **2** to **7** or **0** (Toll saver*).

```
Number of rings
      : 2
▼▲                ▶=Save
```

7 Press **▶** (Save key).
•A beep sounds.
•To exit the programming mode, press **EXIT/STOP**.

```
Number of rings
      : 2
```

- You can exit the programming mode any time by pressing **EXIT/STOP**.

*Toll saver

When you call the unit from a touch tone telephone:

If the unit answers on the 2nd ring, there is at least one new message.

If the unit answers on the 4th ring, there are no new messages.

Hang up when you hear the 3rd ring. This will save you the toll charge for the call.

Making Calls

Cordless Handset

To have a hands-free conversation, connect an optional headset to the handset (p. 76).

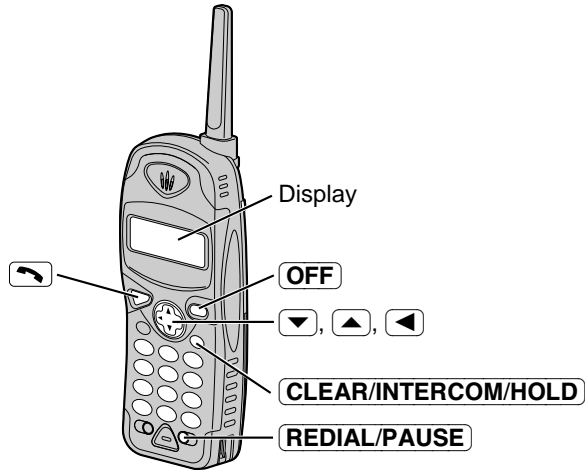

1 Press .

Talk

2 Dial a phone number.

- The dialed number is displayed.
- After a few seconds, the display will show the length of the call and the battery strength.

Talk
11122222

Talk
00-00-00 [■■■■]

3 To hang up, press **OFF** or place the cordless handset on the charger.

Off
00-01-08 [■■■■]

- “Line in use” is displayed on the base unit while the cordless handset is engaged in an outside call.
- If the cordless handset has lost communication with the base unit, 3 beeps sound and “No link to base. Walk closer to base & try again” is displayed.



To dial after confirming the entered number

1 Dial a phone number.

- If you misdial, press **CLEAR/INTERCOM/HOLD** and dial again.

3334444

2 Press

- After a few seconds, the display will show the length of the call and the battery strength.

Talk
3334444

Talk
00-00-00 {■■■■}

3 To hang up, press **OFF** or place the cordless handset on the charger.

Off
00-01-08 {■■■■}

If noise interferes with the conversation

Press to select a clearer channel in the talk, intercom or remote operation mode, or move closer to the base unit.

To redial the last number dialed on the cordless handset

Press → **REDIAL/PAUSE**.

To dial after confirming the last number dialed on the cordless handset

Press **REDIAL/PAUSE** → .

To put a call on hold

Press **CLEAR/INTERCOM/HOLD**.

- "Line on HOLD." is displayed on the base unit.
- The DIGITAL SP-PHONE indicator flashes.
- If you put a call on hold for more than 6 minutes, an alarm tone will sound. The call will be disconnected after a total of 10 minutes.
- To transfer the call to the base unit, see page 55.

To release the hold

From the cordless handset, press _____.

From the base unit, press **DIGITAL SP-PHONE** or lift the handset.

- If another phone is 4f a5 Tw (3se9 Tthe(p. 78),2 Tw c moals91 Tw (To relutes, an)22 To



Base Unit

You can make a call by simply lifting the handset and dialing the phone number. To hang up, place the handset on the cradle.

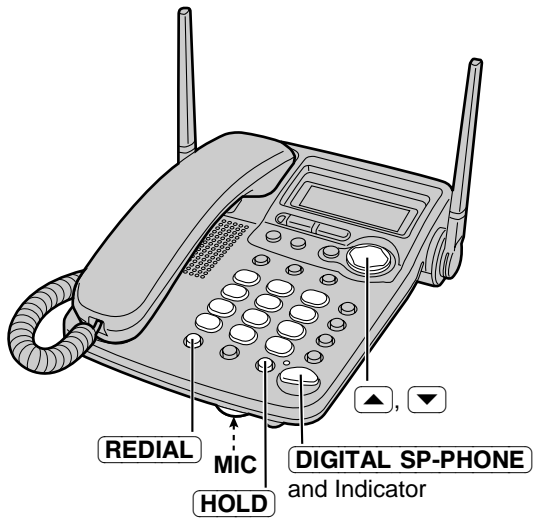

Using the speakerphone

1 Press **DIGITAL SP-PHONE**.
 •The indicator lights.



2 Dial a telephone number.
 •The dialed number is displayed.
 •After a few seconds, the display will show the length of the call.



3 When the other party answers, talk into the **MIC** (microphone).

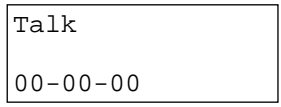

4 To hang up, press **DIGITAL SP-PHONE**.
 •The indicator light goes out.

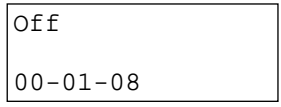



•“Line in use” is displayed on the cordless handset while the base unit is engaged in an outside call.

To redial the last number dialed

Lift the handset or press **DIGITAL SP-PHONE** → **REDIAL**.

To adjust the handset volume (3 levels) or speaker volume (8 levels) while talking

To increase, press .

To decrease, press .

- The display shows the volume level for a few seconds.

To put a call on hold

Press **HOLD**.

- “Line on HOLD.” is displayed on the cordless handset.
- The DIGITAL SP-PHONE indicator flashes.
- If using the handset, you can place it on the cradle.
- If you put a call on hold for more than 6 minutes, an alarm tone will sound. The call will be disconnected after a total of 10 minutes.
- To transfer the call to the cordless handset, see page 55.

To release the hold

From the base unit:



—

Answering Calls

When a call is received, the unit rings and "Incoming call" is displayed. If you subscribe to a Caller ID service, the calling party information will be displayed after the first ring (p. 34). In order to view the Caller ID information, please wait until the second ring to answer a call.

Cordless Handset

Press .

- You can also answer a call by pressing any dialing button **0** to **9**, ***** or **#** (**—Any Key Talk**).
- You can select the ringer volume while a call is being received. Press  or  while the cordless handset is just ringing. To set to OFF, press and hold .



Auto Talk

If you set the Auto Talk feature to ON (p. 19), you can answer a call by lifting the cordless handset off the charger without pressing .



Base Unit

You can answer a call by simply lifting the handset. To hang up, place the handset on the cradle.

Using the speakerphone

- 1 Press **DIGITAL SP-PHONE**.
 - The indicator lights.
- 2 Talk into the **MIC**.
- 3 To hang up, press **DIGITAL SP-PHONE**.
 - The indicator light goes out.



- You can select the ringer volume while a call is being received. Press **RINGER** while the base unit is just ringing. To set to OFF, press and hold **RINGER**.
- When the cordless handset and base unit ringer volumes are set to OFF, they will not ring (p. 20).

Caller ID Service

This unit is compatible with a Caller ID service offered by your telephone company. If you subscribe to a Caller ID service, the calling party's information will be shown on the cordless handset and the base unit after the first ring.

The unit can record information of up to 50 different callers, including the time and date received and the number of times called, in the Caller List. The Caller List information is sorted by the most recent call to the oldest. When the 51st call is received, the first call is deleted.

Using the list, you can automatically call back a caller. You can store the callers' names and numbers from the Caller List into the directory.

If you subscribe to both Caller ID and Call Waiting services, when a second call is received while talking, the new caller's name and phone number will be displayed (p. 58).

How caller information is displayed when a call is received



- Caller information cannot be displayed in the following cases:
 - If the caller dialed from an area which does not provide a Caller ID service, the display will show "Out of area".
 - If the caller has requested not to display his/her information, the display will show "Private caller".
 - If a long distance call is identified, and the caller's name and/or number cannot be received, the display will show "Long distance".
- If your unit is connected to a PBX which does not support Caller ID services, you cannot access those services.
- The name display service may not be available in some areas. For further information, please contact your telephone company.

Using the Caller List



Viewing the Caller List

You can view the caller list with the cordless handset or the base unit. Caller List information includes the caller's name and phone number, the time and date the call was received, and the number of times that caller called (p. 36).

Make sure the base unit and cordless handset are not being used.

Cordless Handset

1 Press or to enter the Caller List.

- The display will show, for example, the following.

5 new calls
 =Directory

- You can go to the directory list by pressing (p. 47).

2 To search from the most recent call, press .
To search from the oldest call, press .

- To scroll between callers, press or .

SMITH, JACK
1-222-333-4444
3:10P JUN.10

3 To exit the list, press **OFF**.

Base Unit

1 Press or to enter the Caller List.

- The display will show, for example, the following.

5 new calls
 =Directory

- You can go to the directory list by pressing (p. 47).

2 To search from the most recent call, press .
To search from the oldest call, press .

- To scroll between callers, press or .

SMITH, JACK
1-222-333-4444
3:10P JUN.10

3 To exit the list, press **EXIT/STOP**.

- If "No items stored" is displayed, the Caller List is empty.
- If there is no name information for a caller, the display will only show the phone number.
- Once new calls have been checked, "√" will be added.
- While you are viewing the Caller List with the cordless handset, another person cannot access the list using the base unit, and vice versa.

► Using the Caller List

What “√” means

When the display shows “√”, you have already viewed this calling information, answered the call, called back the caller or played back the message (p. 64). If the same caller calls again, the call entry with “√” will be replaced with the new call entry.

SMITH, JACK 1-222-333-4444 3:10P JUN.10 √



If a caller calls more than once

The number of times the same caller called is displayed (“×2” to “×9”). The time and date of the most recent call will be recorded. After checking, “×2” to “×9” will be replaced with “√”.



TURNER, CINDY 1-234-456-7890 11:20A JUN.12 ×2

Calling Back from the Caller List

Cordless Handset

- 1 Press  or  to enter the Caller List.

3 new calls ▼▲ ▶=Directory



- 2 Scroll to the desired caller by pressing  or .

TURNER, CINDY 1-234-456-7890 11:20A JUN.12 ×2



- 3 Press .
 - The displayed phone number is dialed automatically.

Talk 12344567890

Base Unit

- 1 Press  or  to enter the Caller List.

3 new calls ▼▲ ▶=Directory

- 2 Scroll to the desired caller by pressing  or .

TURNER, CINDY 1-234-456-7890 11:20A JUN.12 ×2

- 3 Press **DIGITAL SP-PHONE** or lift the handset.
 - The displayed phone number is dialed automatically.

Talk 12344567890

- In some cases, you may have to edit the number before dialing (p. 37, 38). (Ex. You may have to delete “1” and the area code.)
- If a phone number is not displayed in the caller information, you cannot call back that caller.



Editing the Caller's Phone Number

You can edit a phone number into one of 3 patterns to call back or store it into the directory.

The Caller ID Number Auto Edit Feature (p. 39)

This feature will allow the unit to edit a Caller ID number into one of 3 patterns you desired for you automatically in the Caller List. For detail and activation, please see page 39.

Make sure the base unit and cordless handset are not being used.

Cordless Handset

Cordless Telephone

1 Press or to enter the Caller List.

5 new calls
▼▲ ▶=Directory

2 Scroll to the desired caller by pressing or , and press .

PARKER, FRED
1-234-321-5555
11:20A JAN.12 ✓

▶Edit
Save directory
▼▲ ▶=Yes

3 Press (Yes key) at "Edit".

PARKER, FRED
1-234-321-5555
▼=Next ▶=Edit

4 Press (Edit key) to select a pattern.

Ⓐ 321-5555
▼=Next ▶=Edit

•Each time you press (Edit key), the number is rearranged into one of 3 patterns.

Ⓐ Phone no. (7 digit pattern)

Ⓑ 234-321-5555
▼=Next ▶=Edit

Ⓑ Area code - Phone no. (10 digit pattern)

Ⓒ 1- Area code - Phone no. (11 digit pattern)

Ⓒ 1-234-321-5555
▼=Next ▶=Edit

•The order in which patterns Ⓐ-Ⓒ are displayed depends on how the telephone number is displayed in step 3.



5 After editing the number, you can continue with calling back or storing procedures.

To call back, press (p. 36).



To store the number in the directory, press (Next key). Follow the instructions on the display (p. 41). (If the caller has no name information, see page 41, from step 3.)

► Using the Caller List

Base Unit

1 Press  or  to enter the Caller List.

5 new calls
▼▲ ▶=Directory

2 Scroll to the desired caller by pressing  or , and press **FUNCTION/EDIT**.

PARKER, FRED
1-234-321-5555
11:20A JAN.12 ✓

3 Press **FUNCTION/EDIT** to select a pattern.

- Each time you press **FUNCTION/EDIT**, the number is rearranged into one of 3 patterns.

- (a) Phone no. (7 digit pattern)
- (b) Area code - Phone no. (10 digit pattern)
- (c) 1- Area code - Phone no. (11 digit pattern)

- The order in which patterns (a)–(c) are displayed depends on how the telephone number is displayed in step 2.

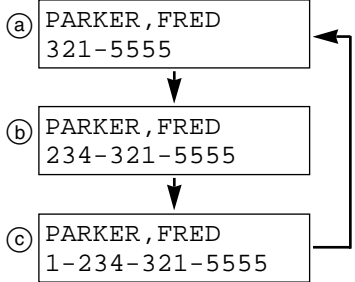

4 After editing the number, you can continue with calling back. Press **DIGITAL SP-PHONE** or lift the handset (p. 36).



The Caller ID Number Auto Edit Feature

Cordless Handset

There are 3 patterns of phone number (a, b, and c, p. 37, 38). This feature allows your phone to automatically edit an in-coming Caller ID number into one pattern you preferred, and display the Caller ID number with that pattern on the base unit and cordless handset automatically.

After this feature is activated, Caller ID numbers coming from considered area codes (201, for example), from which the Caller ID numbers have been chosen to follow the desired pattern (7 digit pattern, for example), will be automatically edited from other patterns (11 digit pattern, for example) into the same pattern you have previously selected (which is 7 digit pattern, in the example).

Up to 4 area codes are allowed for this feature for pattern a and b (p. 37, 38). The Caller ID numbers can be edited automatically on the base unit and the cordless handset separately. Changes made on the cordless handset cannot be used to make a call with the base unit and vice versa.

To activate this feature, you must 1) set this feature to on, and 2) make an out-going call from Caller List (p. 36) with a number which has one of 3 patterns that you have edited with considered area code, and that you prefer to be followed by future Caller ID numbers, so that in the future all the Caller ID numbers coming from the same area code will be displayed in the same pattern.

The Caller ID number Auto Edit feature is preset to ON at factory.

•If you fail to reach your destination when making the call, the phone number you dialed might have an incorrect pattern, please edit the phone number with another pattern (p. 37, 38).

For example, if you move to another area, you may need to turn this feature to OFF to erase previously edited area codes. Then, if still need, you may activate this feature again.

Make sure the base unit and cordless handset are not being used.

1 Press **MUTE/FUNCTION**.

▶Save directory
Ringer volume
▼▲ ▶=Yes

2 Scroll to "Program" by pressing ▼ or ▲.

LCD contrast
▶Program
▼▲ ▶=Yes

3 Press ▶ (Yes key).

▶Set flash time
Set line mode
▼▲ ▶=Yes

(Continued →)

► Using the Caller List

- 4 Scroll to “Caller ID edit” by pressing or .

```
▶Caller ID edit
▼▲                    ▶=Yes
```

- 5 Press (Yes key).

```
Auto edit
:On
▼▲                    ▶=Save
```

- 6 Select “On” or “Off” by pressing or .

```
Auto edit
:Off
▼▲                    ▶=Save
```

- 7 Press (Save key).
- A beep sounds.
 - To exit the programming mode, press **OFF**.

```
Auto edit
:Off
```

- When the feature is set to OFF, the unit will still be able to display Caller ID, like regular Caller ID telephone, but the in-coming Caller ID number will not be edited by pattern and by area codes.



Storing Caller List Information in the Directory Cordless Handset

You can store phone numbers that are in the Caller List into the directory. **Storing must be carried out with the cordless handset.**

Make sure the base unit and cordless handset are not being used.

1 Press or to enter the Caller List.

10 new calls
 =Directory

2 Scroll to the caller you want to store in the directory by pressing or , and press .

TURNER, CINDY
 1-234-456-7890
 11:20A JUN.12 ×3

• If the number requires editing, see page 37.

Edit
 Save directory
 =Yes

3 Scroll to “Save directory” by pressing or , and press (Yes key).

Edit
Save directory
 =Yes

If there is no name information for the caller, “Enter name” will be displayed.

a) If a name is not required, press (Next key) and (Save key).

Enter name
 =Next

b) If a name is required, enter the name (p. 46). When finished, press (Next key) and (Save key).

Enter name
 CINDY TURNER
 =Next

• A beep sounds.

• To continue storing other items, repeat from step 2.

• To exit the programming mode, press **OFF**.

CINDY TURNER
 1-234-456-7890
=Edit =Save

• You can exit the programming mode any time by pressing **OFF**.

• If the display shows “Directory full” in step 3, press **OFF** to exit the list. To erase other stored items from the directory, see page 51.

• After the maximum of 50 items has been stored, “Directory full” is also displayed.

• You cannot store caller information in the directory if a phone number is not displayed.

• If 3 beeps sound and display shows “Save error” in step 3, move closer to the base unit and start again from step 2.

► Using the Caller List



Erasing Caller List Information

After checking the Caller List, you can erase some or all of the entries with the cordless handset or base unit.



Make sure the base unit and cordless handset are not being used.

To erase a specific caller from the Caller List

Cordless Handset

- 1 Press  or  to enter the Caller List.

```
10 new calls
▼▲ ▶=Directory
```

- 2 Scroll to the caller you want to erase from the Caller List by pressing  or .



```
REAGAN, TOM
1-888-777-6666
12:20A JAN.12 ✓
```

- 3 Press **CLEAR/INTERCOM/HOLD**.



```
Clear
```

- A beep sounds and the information is erased.
- To erase other items, repeat from step 2.
- To exit the Caller List, press **OFF**.

Base Unit

- 1 Press  or  to enter the Caller List.

```
10 new calls
▼▲ ▶=Directory
```

- 2 Scroll to the caller you want to erase from the Caller List by pressing  or .

```
REAGAN, TOM
1-888-777-6666
12:20A JAN.12 ✓
```

- 3 Press **CLEAR/ERASE**.



```
Clear
```

- A beep sounds and the information is erased.
- To erase other items, repeat from step 2.
- To exit the Caller List, press **EXIT/STOP**.

To erase all entries in the Caller List

Before erasing all entries, make sure that “0 new call” is displayed.

Cordless Handset

- 1 Press  or  to enter the Caller List.

```

0 new call
▼▲ ▶=Directory
  
```

- 2 Press **CLEAR/INTERCOM/HOLD**.

```

▶Exit
All clear
▼▲ ▶=Yes
  
```

- 3 Scroll to “All clear” by pressing  or .

```

Exit
▶All clear
▼▲ ▶=Yes
  
```



- 4 Press  (Yes key) or **CLEAR/INTERCOM/HOLD**.

```

All clear
  
```

- A beep sounds and all entries are erased.
- The cordless handset will exit the Caller List.

Base Unit

- 1 Press  or  to enter the Caller List.



```

0 new call
▼▲ ▶=Directory
  
```

- 2 Press **CLEAR/ERASE**.

```

▶Exit
All clear
▼▲ ▶=Yes
  
```

- 3 Scroll to “All clear” by pressing  or .

```

Exit
▶All clear
▼▲ ▶=Yes
  
```

- 4 Press  (Yes key) or **CLEAR/ERASE**.

```

All clear
  
```

- A beep sounds and all entries are erased.
- The base unit will exit the Caller List.

Directory

You can store up to 50 names and phone numbers in the directory using the cordless handset. All directory items are sorted by the first word in alphabetical order.

Using the directory, you can make a call by selecting a name on the display of the cordless handset or base unit.

Storing Names and Numbers (Cordless/Handset)

Storing must be carried out with the cordless handset.

Make sure the base unit and cordless handset are not being used.

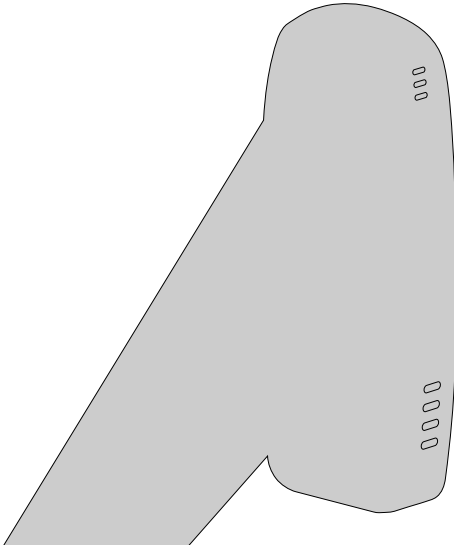

1 Press **MUTE/FUNCTION**.

▶Save directory
Ringer volume
▼▲ ▶=Yes

2 Press **▶** (Yes key) at "Save directory".

- The display shows the number of stored items in the directory.

📖
Directory=
20 items



3 Enter a name, up to 15 characters, with the dialing buttons, or .

- See the steps for entering names and symbols (p. 46).
- If a name is not required, press (Next key) and go to step 5.

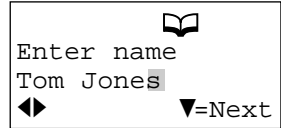
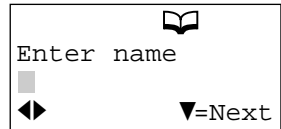

4 Press (Next key).

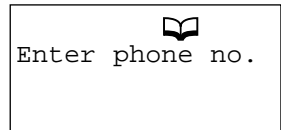

5 Enter a phone number, up to 22 digits.

- Each time you press **CLEAR/INTERCOM/HOLD**, a digit is erased. To erase all of the digits, press and hold **CLEAR/INTERCOM/HOLD**.
- To move the cursor, press or .

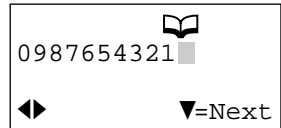

6 Press (Next key).

- If you want to change the storing name or number, press (Edit key) repeatedly to reach the desired display and change it.

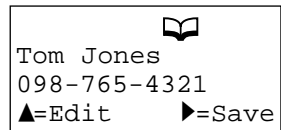

7 Press (Save key).

- A beep sounds.
- To continue storing other items, repeat from step 2.
- To exit the programming mode, press **OFF**.

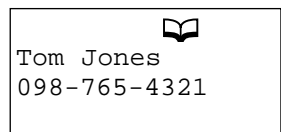

- If a pause is required for dialing, **REDIAL/PAUSE** can be stored in a phone number counting as one digit (p. 58) in step 5.
- You can exit the programming mode any time by pressing **OFF**.
- If the display shows "Directory full" in step 2, the display will return to step 1. Press **OFF** to exit the list. To erase other stored items from the directory, see page 51.
- After the maximum of 50 items has been stored, "Directory full" is also displayed.
- If an alarm tone sounds in step 7, the item cannot be stored in the directory. Press **OFF** and try again from step 1.

► Directory

Entering Names and Symbols (Cordless Handset)

The cordless handset dialing buttons (0 to 9) can be used to enter letters and symbols. The letters are printed on the dialing buttons. Pressing each button selects a character as shown below.



Keys	Number of times key is pressed										
	1	2	3	4	5	6	7	8	9	10	11
1	#	&	'	()	*	,	-	.	/	1
2	a	b	c	A	B	C	2				
3	d	e	f	D	E	F	3				
4	g	h	i	G	H	I	4				
5	j	k	l	J	K	L	5				
6	m	n	o	M	N	O	6				
7	p	q	r	s	P	Q	R	S	7		
8	t	u	v	T	U	V	8				
9	w	x	y	z	W	X	Y	Z	9		
0	0	Blank									
◀	To move the cursor to the left.										
▶	To move the cursor to the right.										

- To enter another character using the same dialing button, press ▶ to move the cursor to the next space.

If you make a mistake while entering a name

Use ◀ or ▶ to move the cursor to the incorrect character, press **CLEAR/INTERCOM/HOLD** to delete and enter the correct character. Each time you press **CLEAR/INTERCOM/HOLD**, a character is erased. To erase all characters, press and hold **CLEAR/INTERCOM/HOLD**.



For example, to enter “Tom Jones”:

- | | | |
|---|--|--|
| 1 | Press 8 four times. | <input type="text" value="T"/> |
| 2 | Press 6 three times, then press ▶ . | <input type="text" value="To"/> |
| 3 | Press 6 once, then press ▶ twice. | <input type="text" value="Tom"/> |
| 4 | Press 5 four times, press 6 three times, then press ▶ . | <input type="text" value="Tom Jo"/> |
| 5 | Press 6 twice, press 3 twice, then press 7 four times. | <input type="text" value="Tom Jones"/> |

Finding Stored Items (Cordless\Handset) (Base\Unit)

You can search the directory using the cordless handset or the base unit. “” is displayed only on the cordless handset display.

Make sure the base unit and cordless handset are not being used.

- 1 Press **◀** or **▶** to enter the directory list.

- You can go to the Caller List by pressing **▶** (p. 35).

- 2 Press **▼** or **▲**.
- The first item is displayed.

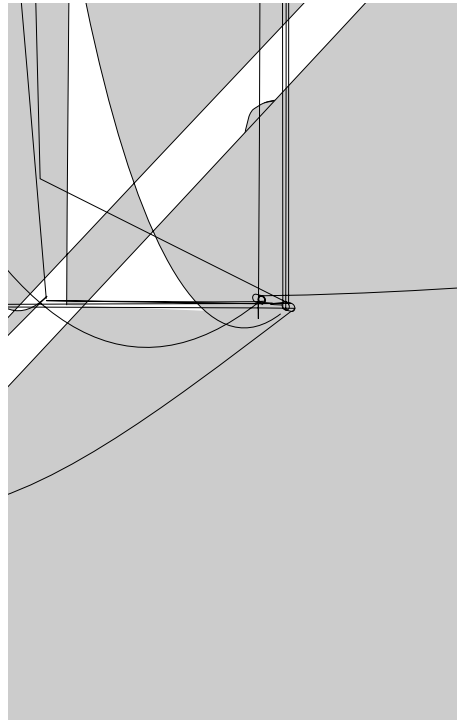

► Directory

3 Scroll to the desired item by pressing **▼** or **▲**.

- All directory items are stored in the order shown on the right.

To search for a name by initial

① Press the dialing button for the first letter of the desired name until any name with the same initial is displayed (see the Index table below).

Ex. To find "Frank", press **3** repeatedly until the first item under "F" is displayed.

② Press **▼** repeatedly until the name is displayed.

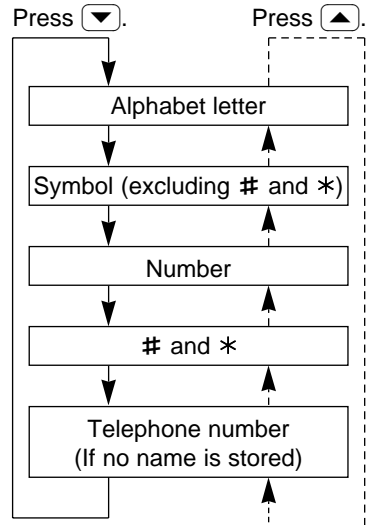

- You can exit the directory list any time by pressing **OFF** or **EXIT/STOP**.
- If "No items stored" is displayed in step 2, the directory is empty.

Index table



Keys	Index	Keys	Index
1	Other symbols, 1	6	M, N, O, 6
2	A, B, C, 2	7	P, Q, R, S, 7
3	D, E, F, 3	8	T, U, V, 8
4	G, H, I, 4	9	W, X, Y, Z, 9
5	J, K, L, 5	0	0





Dialing (Cordless\Handset) (Base\Unit)

“” is displayed only on the cordless handset display.

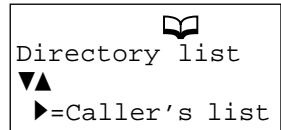

Make sure the base unit and cordless handset are not being used.

- 1 Press  or  to enter the directory list.

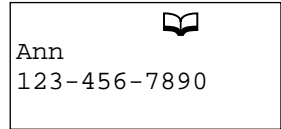

- 2 Press  or .
- The first item is displayed.



- 3 Scroll to the desired item that you want to dial by pressing  or .
- To search for the item by initial, see page 48.

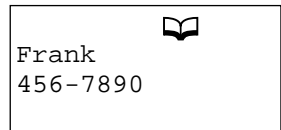

- 4 **Cordless handset:**
Press .
- Base unit:**
Press **DIGITAL SP-PHONE**, or lift the handset.
- The number is dialed automatically.

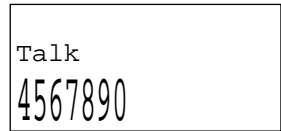

- 5 To hang up,
- Cordless handset:**
Press **OFF** or place the cordless handset on the charger.
- Base unit:**
Press **DIGITAL SP-PHONE**, or place the handset on the cradle.

- You can exit the directory list any time as follows:
When using the cordless handset, press **OFF**.
When using the base unit, press **EXIT/STOP**.

► Directory

Editing (Cordless/Handset)

Make sure the base unit and cordless handset are not being used.

- 1 Press ◀ or ▶ to enter the directory list.

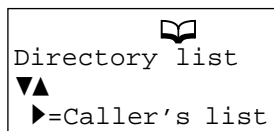

- 2 Press ▼ or ▲.
•The first item is displayed.

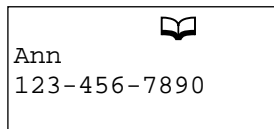

- 3 Scroll to the directory item you want to change by pressing ▼ or ▲, and press ▶.
•To search for the item by initial, see page 48.
•If you do not need to change the name, go to step 5.

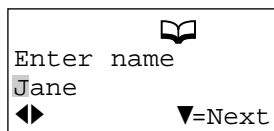

- 4 Edit the name using the dialing buttons, ◀ or ▶ (p. 46), up to 15 characters.

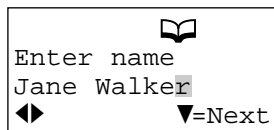

- 5 Press ▼ (Next key).

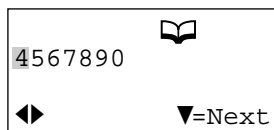

- 6 Add a number to the current number.
•If you do not need to change the number, press ▼ (Next key) and go to step 8.
•Each time you press **CLEAR/INTERCOM/HOLD**, a digit is erased. To erase all of the digits, press and hold **CLEAR/INTERCOM/HOLD**.
•To move the cursor, press ◀ or ▶.

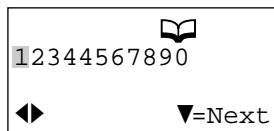

- 7 Press (Next key).
- If you want to change the storing name or number, press (Edit key) repeatedly to reach the desired display and change it.

Jane Walker
1-234-456-7890
=Edit =Save

- 8 When finished, press (Save key).
- A beep sounds.
 - To continue editing other items, repeat from step 3.
 - To exit the directory list, press **OFF**.

Jane Walker
1-234-456-7890

- You can exit the edit mode any time by pressing **OFF**.

Erasing (Cordless\Handset) (Base\Unit)

“” is displayed only on the cordless handset display.

Make sure the base unit and cordless handset are not being used.

- 1 Press or to enter the directory list.

Directory list

=Caller's list

- 2 Press or .
- The first item is displayed.

Ann
123-456-7890

- 3 Scroll to the directory item that you want to erase by pressing or .
- To search for the item by initial, see page 48.

Helen
1-234-567-8901

- 4 **Cordless handset:**
Press **CLEAR/INTERCOM/HOLD**.

Clear?
=No =Yes

Base unit:

Press **CLEAR/ERASE**.

- To stop erasing, press (No key).

- 5 **Cordless handset:**
Press (Yes key) or **CLEAR/INTERCOM/HOLD**.

Clear

Base unit:

Press (Yes key) or **CLEAR/ERASE**.

- A beep sounds.

- You can exit the directory list any time as follows:
When using the cordless handset, press **OFF**.
When using the base unit, press **EXIT/STOP**.

THE TOUCH PANEL

Storing Phone Numbers in Memory (Base Unit)

You can store up to 3 phone numbers in the DIRECT buttons.
Make sure the base unit and cordless handset are not being used.

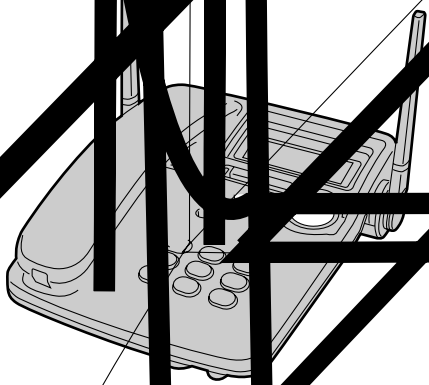

1 Press **FUNCTION/EXIT**.

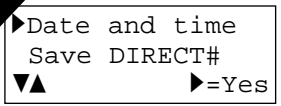

2 Scroll to the **DIRECT#** by pressing **▼** or **▲**.

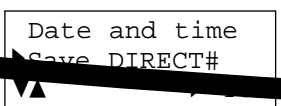

3 Press **▶** (Yes key).

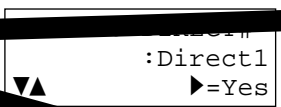

4 Scroll to the desired direct button by pressing **▼** or **▲**.



- You can select the desired direct button by pressing dialing buttons **1** (DIRECT1), **2** (DIRECT2) or **3** (DIRECT3).

5 Press (Yes key).



6 Enter a phone number, up to 22 digits.

- Each time you press **CLEAR/ERASE**, a digit is erased. To erase all of the digits, press and hold **CLEAR/ERASE**.
- To move the cursor, press or .

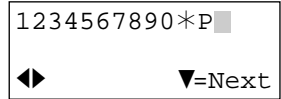

7 Press (Next key).

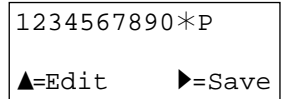

8 Press (Save key).

- A beep sounds.
- To store other numbers, repeat from step 4.
- To exit the programming mode, press **EXIT/STOP**.

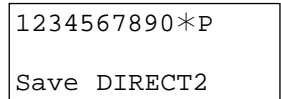

- If a pause is required for dialing, **PAUSE** can be stored in a phone number counting as one digit (p. 58) in step 6.
- You can exit the programming mode any time by pressing **EXIT/STOP**.

To erase a stored number

Repeat steps 1 through 5 → press and hold **CLEAR/ERASE** until all of the digits are erased → (Next key) → (Save key).

Dialing (Base\Unit)

1 Press the required DIRECT button (**DIRECT1**, **DIRECT2** or **DIRECT3**).

- If 3 beeps sound, you have not stored the phone numbers in the DIRECT buttons. Store the number.
 - The DIGITAL SP-PHONE indicator lights.
 - The stored number is dialed.
- Numbers stored in the base unit can only be dialed by the base unit.
 - You can also dial the stored number by pressing **DIGITAL SP-PHONE** or lifting the handset then pressing the DIRECT button.

Intercom

(Cordless\Handset) (Base\Unit)

A 2-way intercom is possible between the cordless handset and the base unit.

Paging the base unit from the cordless handset

1 Cordless handset:

Press **CLEAR/INTERCOM/HOLD**.
Talk to the paged party after the beeps.

- “Intercom” is displayed.

2 Base unit:

When the other party’s voice is heard, lift the handset or talk into the **MIC**.

3 To end the intercom, press

OFF on the cordless handset.

OR

When using the handset, place the handset on the cradle.

When using the speakerphone, press **LOCATOR/INTERCOM**.

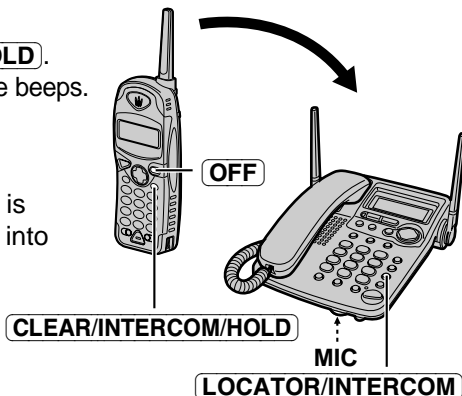

Paging the cordless handset from the base unit (Handset locator)

Using this feature, you can locate a misplaced cordless handset.

1 Base unit:

Lift the handset and press **LOCATOR/INTERCOM** within 5 seconds.

- The cordless handset beeps for 1 minute and displays “Paging Press INTERCOM”.
- To stop paging, place the handset on the cradle.

2 Cordless handset:

Press **CLEAR/INTERCOM/HOLD** to answer.

- “Intercom” is displayed.

3 Base unit:

Talk into the handset.

4 To end the intercom, press

OFF on the cordless handset.

Place the handset on the cradle.



- In step 1, the base unit user can also page by pressing **LOCATOR/INTERCOM** directly. You do not need to lift the handset.

—If the cordless handset user does not answer, press **LOCATOR/INTERCOM** to stop paging.

—If the cordless handset user answers, talk into the **MIC**.

To end the intercom from the base unit, press **LOCATOR/INTERCOM**.

During an intercom call:

- If the cordless handset user has difficulty hearing the base unit user, decrease the base unit speaker volume by pressing .
- If an incoming call is received, the intercom call stops and the unit starts to ring. To answer, press , **DIGITAL SP-PHONE** or place the handset and lift it again. The intercom is ended.

Transferring a Call Using the Intercom (Cordless\Handset) (Base\Unit)

The intercom can be used during a call. This feature enables you to transfer a call between the cordless handset and the base unit.

From the cordless handset to the base unit

- Cordless handset:**
During a call, press **CLEAR/INTERCOM/HOLD**.

- The call is put on hold and "Line on HOLD."
To transfer press INTERCOM." is displayed.

- Press **CLEAR/INTERCOM/HOLD** again. Talk to the paged party after the beeps.

```
Line on HOLD.
      ▶=Conference
Intercom  {■■■■}
```

- If the base unit user does not answer, press  to return to a call.

- Base unit:**
When the other party's voice is heard, lift the handset or talk into the **MIC**.

- To complete the transfer:
 - when using the handset, press **OFF** on the cordless handset.
 - when using the speakerphone, press **DIGITAL SP-PHONE**.

From the base unit to the cordless handset

- Base unit:**
During a call, press **LOCATOR/INTERCOM**.

- The call is put on hold and DIGITAL SP-PHONE indicator flashes.

- If the cordless handset user does not answer:
 - when using the handset, press **LOCATOR/INTERCOM**, then press **HOLD** to return to a call.

- when using the speakerphone, press **DIGITAL SP-PHONE** to return to a call.

- Cordless handset:**
Press **CLEAR/INTERCOM/HOLD** to answer the page.

```
Line on HOLD.
      ▶=Conference
Intercom  {■■■■}
```

- To complete the transfer:
 - when using the handset, place the handset on the cradle.
 - when using the speakerphone, press  on the cordless handset.

Conference

While you are talking with an outside caller, you can call the base unit or cordless handset to make a conference call.

(Cordless\Handset)

1 Cordless handset:
During a call, press **CLEAR/INTERCOM/HOLD**.

- The call is put on hold and “Line on HOLD.
To transfer press INTERCOM.” is displayed.

2 Press **CLEAR/INTERCOM/HOLD** again. Talk to the paged party after the beeps.

Line on HOLD.
▶=Conference
Intercom

- If the base unit user does not answer, press  to return to a call.

3 Base unit:
When the other party’s voice is heard, lift the handset or talk into the **MIC**.

4 Press  (Conference key) to make a conference call on the cordless handset or the base unit.

- During a conference, the outside call can be placed on hold by pressing **CLEAR/INTERCOM/HOLD** on the cordless handset or **HOLD** on the base unit. Internal communications between extensions are not suspended. To resume the conference, press  (Conference key) on the cordless handset or the base unit.
 - To leave the conference,
 - For the cordless handset; press **OFF** or place the cordless handset on the charger.
 - For the base unit;
 - When talking with the speakerphone, press **DIGITAL SP-PHONE**.
 - When talking with the handset, place the handset on the cradle.
- The two other parties can continue the conversation.

(Base\Unit)

1 Base unit:
During a call, press **LOCATOR/INTERCOM**.

- The call is put on hold and DIGITAL SP-PHONE indicator flashes.
- If the cordless handset user does not answer:
 - when using the handset, press **LOCATOR/INTERCOM**, then press **HOLD** to return to a call.
 - when using the speakerphone, press **DIGITAL SP-PHONE** to return to a call.

2 Cordless handset:
Press **CLEAR/INTERCOM/HOLD** to answer the page.

Line on HOLD.
▶=Conference
Intercom

3 Press  (Conference key) to make a conference call on the cordless handset or the base unit.

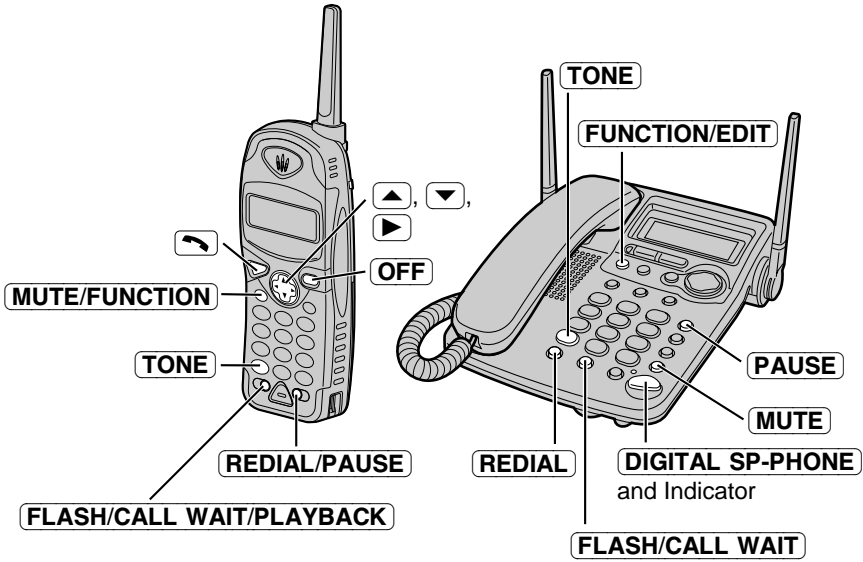

Temporary Tone Dialing (For Rotary or Pulse Service Users) (Cordless\Handset) (Base\Unit)

Press **TONE** before entering access numbers which require tone dialing.

- The dialing mode changes to tone. You can enter numbers to access an answering service, electronic banking service, etc. When you hang up, the mode will return to pulse.

Muting Your Conversation (Cordless\Handset) (Base\Unit)

Cordless handset:

Press **MUTE/FUNCTION** while talking.

- “<MUTE>” flashes.

Base unit:

Press **MUTE** while talking.

- “<MUTE>” flashes.
- The other party cannot hear your voice but you can hear theirs.
- **To release the mute**, press **MUTE/FUNCTION** on the cordless handset or **MUTE** on the base unit.

► Special Features

For Call Waiting Service Users

(Cordless\Handset) (Base\Unit)

Press **FLASH/CALL WAIT/PLAYBACK** or **FLASH/CALL WAIT** if you hear a call-waiting tone while talking.

- The first call is put on hold and you can answer the second call.
- To return to the first caller, press **FLASH/CALL WAIT/PLAYBACK** or **FLASH/CALL WAIT** again.
- The call waiting service cannot be used when:
 - the answering system is recording someone's message, or
 - a parallel connected telephone is in use.
- If this function does not operate properly, consult your telephone company for details.

Call Waiting Caller ID Feature

Call Waiting Caller ID Feature allows the unit to display the second caller's information. After you hear a call-waiting tone while talking, the unit will display the caller's name with the phone number and "----Waiting----".

BROWN, NANCY 555-666-7777 ----Waiting----

- Please contact your telephone company for details and availability in your area.

How to Use the PAUSE Button

(For PBX Line/Long Distance Calls)

(Cordless\Handset) (Base\Unit)

We recommend you press **REDIAL/PAUSE** or **PAUSE** if a pause is required for dialing with a PBX or to make a long distance call.

Ex. Line access number **9** (PBX)

9 → **REDIAL/PAUSE** or **PAUSE** → Phone number

- Pressing **REDIAL/PAUSE** or **PAUSE** once creates a 3.5 second pause. This prevents misdialing when you redial or dial a stored number.
- Pressing **REDIAL/PAUSE** or **PAUSE** more than once increases the length of the pause between numbers.



FLASH Button (Cordless\Handset) (Base\Unit)

Pressing **FLASH/CALL WAIT/PLAYBACK** or **FLASH/CALL WAIT** allows you to use special features of your host PBX such as transferring an extension call or accessing special telephone services (optional) such as call waiting.

- Pressing **FLASH/CALL WAIT/PLAYBACK** or **FLASH/CALL WAIT** causes to release following operations:
 - temporary tone dialing,
 - muting your conversation.

Selecting the flash time (Cordless\Handset)

The flash time depends on your telephone exchange or host PBX. You can select the following flash times: “700, 600, 400, 300, 250, 110, 100 or 90 ms (milliseconds)”. Your phone comes from the factory set to “700 ms”.

Make sure the base unit and cordless handset are not being used.

1 Press **MUTE/FUNCTION**.

▶Save directory
Ringer volume
▼▲ ▶=Yes

2 Scroll to “Program” by pressing ▼ or ▲.

LCD contrast
▶Program
▼▲ ▶=Yes

3 Press ▶ (Yes key).

▶Set flash time
Set line mode
▼▲ ▶=Yes

4 Press ▶ (Yes key) at “Set flash time”.
•The current setting is displayed.

Flash time
:700ms
▼▲ ▶=Save

5 Select the desired time by pressing ▼ or ▲.

Flash time
:110ms
▼▲ ▶=Save

6 Press ▶ (Save key).

- A beep sounds.
- To exit the programming mode, press **OFF**.

Flash time
:110ms

- You can exit the programming mode any time by pressing **OFF**.
- If the unit is connected via a PBX, PBX functions (transferring a call etc.) might not work correctly. Consult your PBX supplier for the correct setting.

► Special Features

Security Code Setting (Cordless\Handset&\Base\Unit)

If “No link to base. Walk closer to base & try again” is displayed even if you use the cordless handset near the base unit, the cordless handset may lose communication with the base unit. It is necessary to set the same security code between the base unit and cordless handset. Follow the steps below.

1 Base unit:
Press **FUNCTION/EDIT**.

►Date and time
Save DIRECT#
▼▲ ▶=Yes

2 Press **7**, **3**, then **4**.
•No sound is present each time you press the dialing button. Confirm that the display on the right will be shown after pressing the buttons.

Portable
Registering

3 Cordless handset:
Press **MUTE/FUNCTION**.

►Save directory
Ringer volume
▼▲ ▶=Yes

4 Press **7**, **3**, then **4**.
•No sound is present each time you press the dialing button. Confirm that the display on the right will be shown after pressing the buttons.
•After the setting is completed, “Portable Registered” is displayed and a beep sounds from the base unit and cordless handset.

Portable
Registered

•3 beeps sound and “Error!!” is displayed when you fail to set the security code. Try again from step 1.

Automatic Answering Operation ▶

When the unit answers a call, a greeting message is played and the caller's message is recorded. While recording, "- Answering -" will flash on the cordless handset and base unit displays.

- The total recording time (including greeting message) is **about 15 minutes**. If messages are recorded in noisy rooms, the time may be shortened by up to 3 minutes.
- A maximum of 64 messages (including greeting message) can be recorded.

Setting the Unit to Answer Calls Base Unit

Press **(ANSWER\ON)** to turn on the answering system.

- The indicator lights and the unit announces "Answer set" and the current day and time.
- The unit will announce the remaining recording time if it is less than 5 minutes.
- If you hear "Memory full", "Message full" flashes on the base unit display and the ANSWER ON indicator flashes rapidly, erase some, or all, of the messages (p. 65).

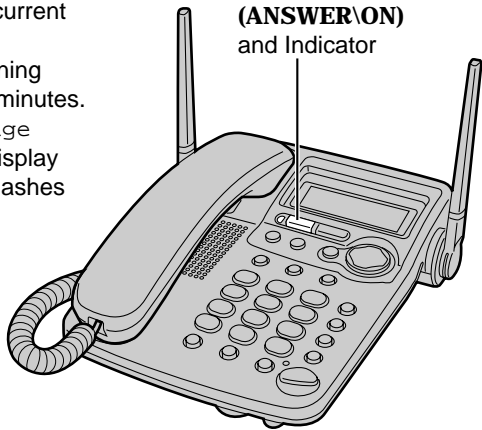

- If you do not want the unit to answer calls, press **(ANSWER\ON)** again to turn off the answering system. The indicator light goes out and "Answer off" is heard.
- You can also turn on the answering system remotely using any other phone (p. 71).

Answering System

► Automatic Answering Operation

Call Monitoring Feature **Base Unit**

While a call is being recorded, you can monitor it through the speaker.

- To increase the speaker volume, press (<). To decrease, press (>).

To answer the call with the base unit, lift the handset or press **(DIGITAL\SP-PHONE)**. For the cordless handset, press . The unit stops recording.

If the call monitoring feature is not required, turn the feature OFF by programming. Your phone comes from factory set to "ON".

Make sure the base unit and cordless handset are not being used.

- 1 Press **(FUNCTION/EDIT)**.
- 2 Scroll to "Set answering" by pressing (>) or (<).
- 3 Press **(f1)** (Yes key).
- 4 Scroll to "Call monitoring" by pressing (>) or (<).
- 5 Press **(f1)** (Yes key).
 - The current setting is displayed.
- 6 Select "On" or "Off" by pressing (>) or (<).

- 7 Press **(f1)** (Save key).
- A beep sounds.
 - To exit the programming mode, press **(EXIT/STOP)**.

Call monitoring
: Off

- You can exit the programming mode any time by pressing **(EXIT/STOP)**.

Listening to Messages



Base Unit

You can see the total number of recorded messages on the base unit display. If the ANSWER ON indicator flashes, new messages have been recorded.

To play back messages, press **(MESSAGE\PLAYBACK)**.

When you have new messages:

the unit announces the number of new messages and only new messages are played back.

When you have no new messages:

the unit announces "No new messages. All message playback" and plays back all messages.

When you have no messages:

the unit announces "No messages".

- At the end of the last message, "End of final message" is heard. The unit will announce the remaining recording time if it is less than 5 minutes.

To adjust the speaker volume:

9 levels (0–8) are available during playback.

To increase, press (**<**). To decrease, press (**>**).

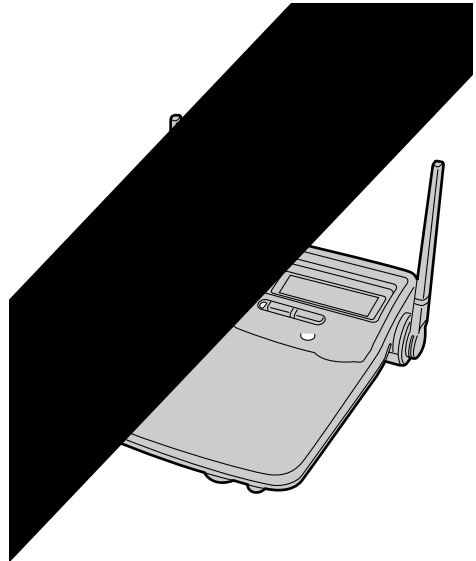

► Listening to Messages

During playback

To repeat message	Press (f1) . <ul style="list-style-type: none">• If you press within 5 seconds of playback, the previous message will be played.
To skip message	Press (f1) briefly.
To stop operation	Press (EXIT/STOP) . <ul style="list-style-type: none">• To resume playback, press (MESSAGE\PLAYBACK).• If you press (EXIT/STOP) again, the playback mode will be canceled.

For Caller ID service users (p. 34)

During playback, the base unit display will show the name and/or number of the caller whose message is being played.

SMITH, JACK 1-222-333-4444 - Message 3 -
--

To call back the displayed number:

During playback, lift the handset or press **(DIGITAL\SP-PHONE)**.

—The unit stops playback and automatically dials the displayed phone number.

- After listening to new incoming messages, “√” will be added to the call entries in the Caller ID Caller List (p. 36).

Erasing Messages

Base Unit

The unit will announce the remaining recording time after playback, if it is less than 5 minutes. New messages cannot be recorded when:

- “Memory full” is heard.
- “Message full” flashes on the base unit display.
- the ANSWER ON indicator flashes rapidly (only when the Answering System is on).

Erase some, or all, of the messages. We recommend you erase unnecessary messages after each playback.

Erasing a specific message

Press **(CLEAR/ERASE)** while the message you want to erase is being played.

- The unit erases the message.
- A short beep will sound and the unit will continue to play the next message.

Erasing all messages

All recorded messages, except the greeting message, can be erased at one time.

- 1 Press **(CLEAR/ERASE)**.
 - “To erase all messages, press ERASE again” is heard.
- 2 Within 5 seconds, press **(CLEAR/ERASE)** again.
 - A beep sounds and “No messages” is heard.
 - The base unit display shows “0 message”.

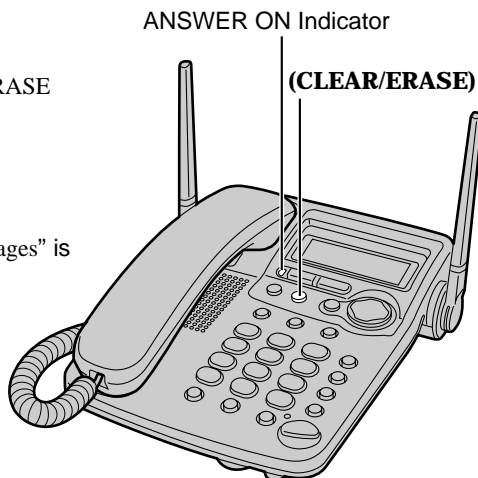

- The information in the Caller List will not be erased. To erase Caller List information, see pages 42 and 43.

Remote Operation from a Touch Tone Phone

You can operate the answering system from any touch tone phone. A synthesized voice menu will guide you on how to operate the unit (p. 68).

- To skip the voice menu and operate the unit directly, see page 70.

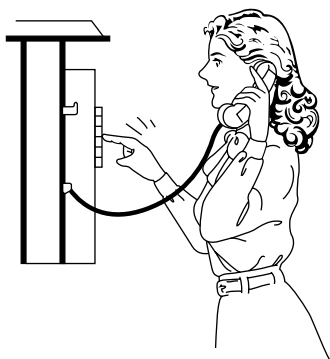

Summary of remote operation

Call your unit from a touch tone phone.



Enter your remote code (p. 67) during or after the greeting message.

- The number of new messages is heard.



After 3 seconds, the voice menu will start (p. 68).
Follow the menu or enter the direct commands (p. 70).



To end remote operation, hang up.

- The messages are saved.

- The unit will announce the remaining recording time after playback, if it is less than 5 minutes.



Remote Code Base Unit

The remote code prevents unauthorized people from accessing your unit and listening to your messages. Choose any **2-digit number (00–99)**. The factory preset remote code is “11”. If you do not program your own remote code, you can use “11”.

Make sure the base unit and cordless handset are not being used.

1 Press **(FUNCTION/EDIT)**.

```
▶Date and time
  Save DIRECT#
▼▲                ▶=Yes
```

2 Scroll to “Set answering” by pressing (>) or (<).

```
  LCD contrast
▶Set answering
▼▲                ▶=Yes
```

3 Press **(f1)** (Yes key).

```
▶Greeting record
  Greeting check
▼▲                ▶=Yes
```

4 Scroll to “Remote code” by pressing (>) or (<).

```
▶Remote code
  Number of rings
▼▲                ▶=Yes
```

5 Press **(f1)** (Yes key).
•The current setting is displayed.

```
Remote code
                               :11
                               ▶=Save
```

6 Enter a remote code using a **2-digit number (00–99)**.

```
Remote code
                               :35
                               ▶=Save
```

7 Press **(f1)** (Save key).
•A beep sounds.
•To exit the programming mode, press **(EXIT/STOP)**.

```
Remote code
                               :35
```

•You can exit the programming mode any time by pressing **(EXIT/STOP)**.

To check the remote code

Repeat steps 1 to 5.

•The current remote code is displayed. When finished, press **(EXIT/STOP)**.

Remote Operation from a Touch Tone Phone

Voice Menu

The shaded boxes are voice prompts.

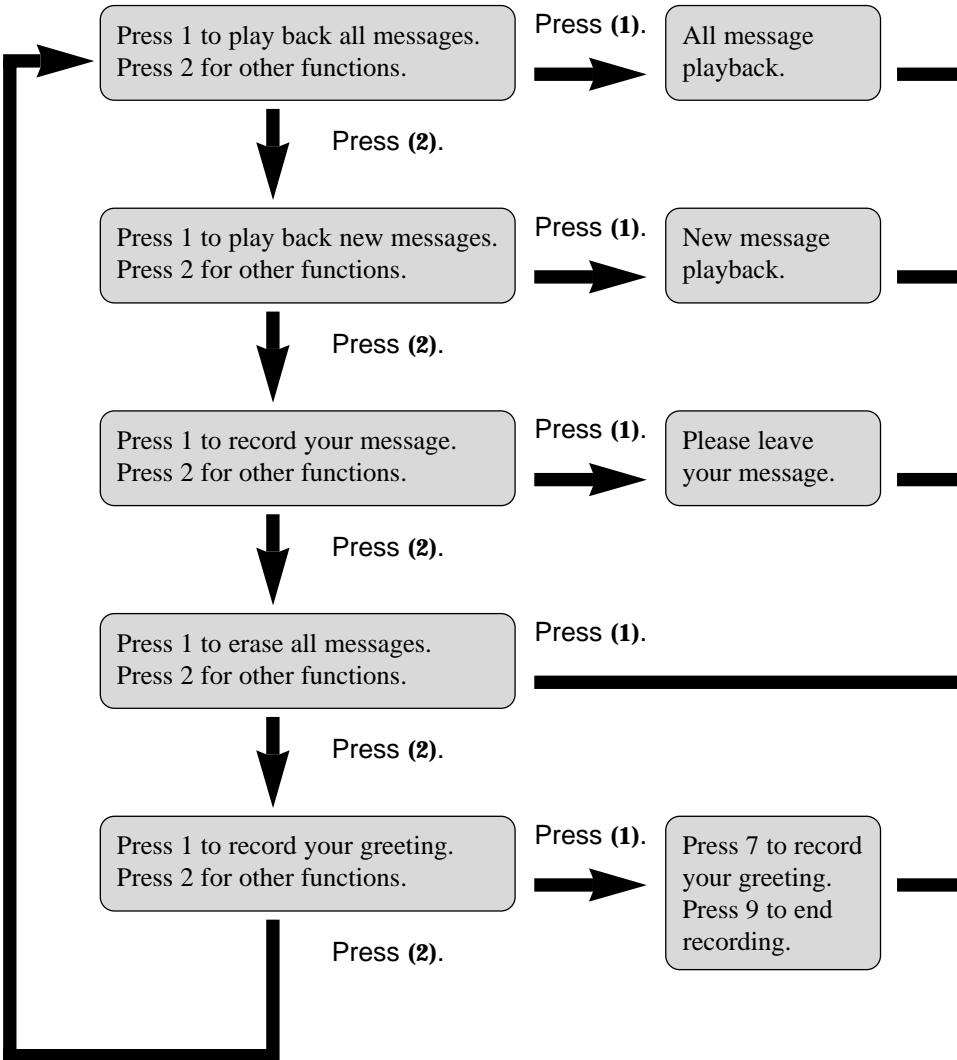



All Message Playback

All recorded messages are played back. At the end of the last message, "End of final message" is heard. The unit will announce the remaining recording time if it is less than 5 minutes.

New Message Playback

Only new messages are played back. At the end of the last message, "End of final message" is heard. The unit will announce the remaining recording time if it is less than 5 minutes.

Recording a Memo Message

You can leave a personal message.

1. Talk after you hear "Please leave your message".
2. When you finish recording, hang up.

Erasing All Messages

All recorded messages (except greeting message) are erased.

Recording a Greeting Message

You can re-record your greeting message.

1. Press **(7)**.
You will hear a voice prompt followed by a long beep.
2. After the beep, talk for up to 2 minutes.
3. When you finish recording, press **(9)**.
4. Your greeting will be played back for confirmation.

- 3 seconds after playback, the voice menu will start again from the beginning.
- If you hear "Memory full" after playback, erase some, or all, of the messages (p. 70).

► Remote Operation from a Touch Tone Phone

Direct Remote Operation

Once you have entered the remote code, you can also control your unit by direct commands instead of using the voice menu. To end the remote operation, hang up anytime.

Direct commands

NEW MESSAGE PLAYBACK	(4)	<ul style="list-style-type: none">• Only new messages are played back.
ALL MESSAGE PLAYBACK	(5)	<ul style="list-style-type: none">• All messages are played back.
REPEAT (During playback)	(1)	<ul style="list-style-type: none">• The current message is repeated.• If you press within 5 seconds of playback, the previous message will be played.
SKIP (During playback)	(2)	<ul style="list-style-type: none">• The current message is skipped. The next message is played.
STOP	(9)	<ul style="list-style-type: none">• Operation is stopped temporarily.• To resume operation, enter a direct command within 15 seconds, or the voice menu will start (p. 68).
GREETING MESSAGE RECORDING	(7) ☒	<ul style="list-style-type: none">• A long beep sounds.
RECORD ☒	(9)	<ul style="list-style-type: none">• After the beep, talk immediately for up to 2 minutes.• The recording is stopped.• The recorded message is played.
ERASING A SPECIFIC MESSAGE (During playback)	(\$) (4)	<ul style="list-style-type: none">• The current message is erased.• A short beep will sound and the next message will be played.
ERASING ALL MESSAGES	(\$) (5)	<ul style="list-style-type: none">• All recorded messages are erased.• A long beep sounds and “No messages” is heard.

ANSWERING
SYSTEM OFF

(0)

- The unit hangs up and will not answer calls until turned on again.
-

Turning on the answering system

Call your unit and wait for 15 rings.

- The unit will answer and the greeting message will be played.
- The answering system will turn on. Hang up or enter the remote code for other options.
- When turning on the answering system using a rotary or pulse service telephone, you cannot enter the remote code for other options.

Skipping the greeting message

After calling your unit, press **(\$)** during the greeting message.

- The unit skips the rest of the greeting message and you can start recording your message after the long beep.

Remote Operation with the Cordless Handset

Cordless Handset

You can operate your answering system with the cordless handset.

The announcements and recorded messages can only be heard with the cordless handset.

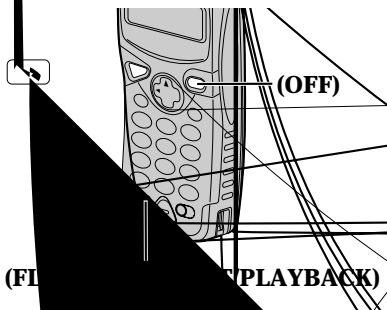

Summary of remote operation

Press **(FLASH/CALL/WAIT/PLAYBACK)**.

- The number of new messages is heard.
- “Remote operation” is displayed on the cordless handset.

Enter the desired direct commands (p. 73).

- If you do not enter a command, the voice menu will start.
- After the voice menu, all message playback will start.

To end remote operation, press **(OFF)**.

- The messages are saved.

- The unit will announce the remaining recording time after playback if the remaining time is less than 5 minutes.
- If the unit starts to ring during the remote operation, press  to answer the call. The remote operation is ended.
- If you hear “Memory full” after playback, erase some, or all, of the messages (p. 73).

Voice menu

If no commands are entered after you press **(FLASH/CALL/WAIT/PLAYBACK)**, the unit will start the following voice menu.

“Press 4 to play back new messages. Press 5 to play back all messages.”

- You can enter direct commands even if the voice menu has started.

Direct commands

NEW MESSAGE PLAYBACK	(4)	<ul style="list-style-type: none">• Only new messages are played back.
ALL MESSAGE PLAYBACK	(5)	<ul style="list-style-type: none">• All messages are played back.
REPEAT (During playback)	(1)	<ul style="list-style-type: none">• The current message is repeated.• If you press within 5 seconds of playback, the previous message will be played.
SKIP (During playback)	(2)	<ul style="list-style-type: none">• The current message is skipped. The next message is played.
STOP	(9)	<ul style="list-style-type: none">• Operation is stopped temporarily.• To resume operation, enter a direct command within 15 seconds, or the voice menu will start (p. 72).
ERASING A SPECIFIC MESSAGE (During playback)	(\$) (4)	<ul style="list-style-type: none">• The current message is erased.• A short beep will sound and the next message will be played.
ERASING ALL MESSAGES	(\$) (5)	<ul style="list-style-type: none">• All recorded messages are erased.• A long beep sounds and “No messages” is heard.
ANSWERING SYSTEM OFF	(0)	<ul style="list-style-type: none">• “Answer off” is heard and the answering system is turned off.
ANSWERING SYSTEM ON	(8)	<ul style="list-style-type: none">• “Answer set” is heard and the answering system is turned on.

Wall Mounting

Base unit

The base unit can be mounted on a wall phone plate.

1 Pull down the handset hook until it locks, **so the tab holds the handset.**

2 Press the tabs in the direction of the arrows (①), then remove the wall mounting adaptor (②).

3 Connect the AC adaptor. Tuck the telephone line cord inside the wall mounting adaptor, then push it in the direction of the arrow (① and ②).

- The word "UP WALL" should face upward.

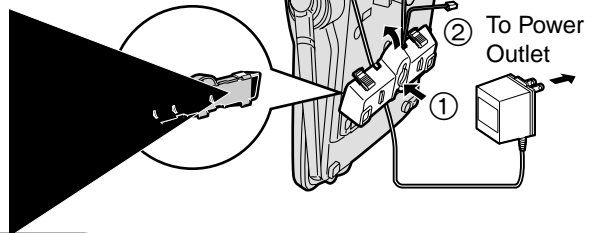

Wall Template for the Charger Unit



4 Connect the telephone line cord.
Mount the base unit, then slide down.

- Raise the antennas.

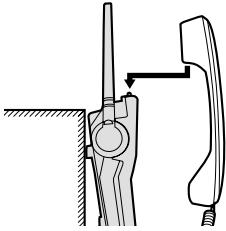
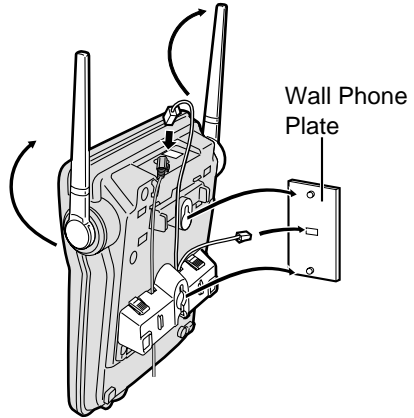

To temporarily set the handset down during a conversation, place it as shown here.

Charger unit

The charger can be wall mounted. Connect the AC adaptor. Install screws using the wall template (p. 74). Mount the charger (①). Slide it down (②), then slide down to the right (③) until it is secured.

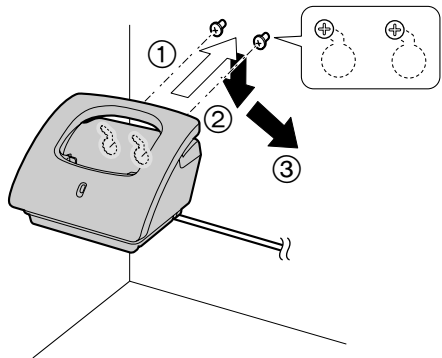
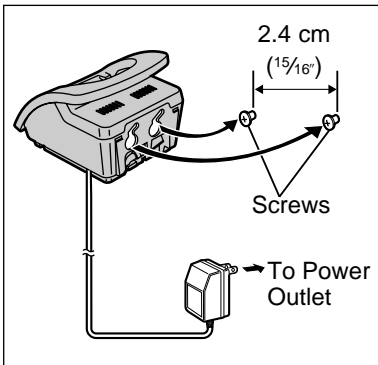

You can hang the cordless handset on your belt or pocket using the belt clip.

To attach the belt clip

To remove the belt clip

Optional Headset

Plugging an optional headset into the cordless handset allows you to have a hands-free phone conversation. Please use only the Panasonic optional headset. To order, call the accessories telephone number.

Connecting the optional headset to the cordless handset

Open the headset jack cover, and plug the headset to the headset jack as shown below.

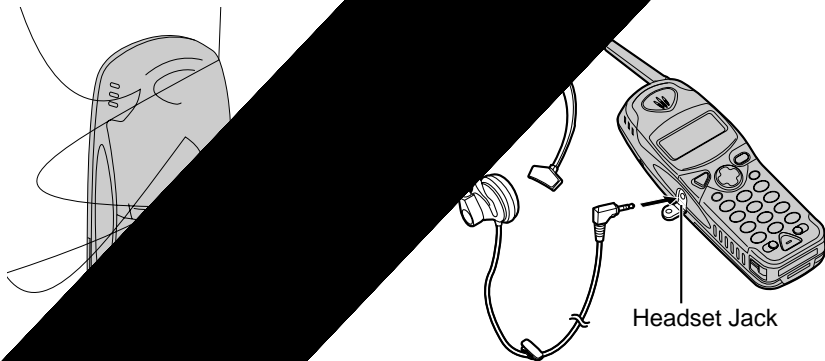

When the headset is connected to the cordless handset, you can use the headset to talk with the caller. If you want to have a cordless phone conversation, disconnect the

Battery Replacement

If “Recharge battery” is displayed and/or “[■]” flashes after a few telephone calls even if the battery was fully charged, replace the battery with a new Panasonic PQP510SVC (P-P510) battery. To order, call the accessories telephone number on page 2.

- 1** Carefully insert a flat metal object in the slot, and push forward to release the lock. Remove the cordless handset cover.

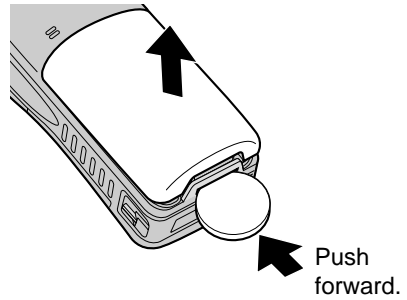

- 2** Replace the battery. Then place the battery leads inside the groove, otherwise the leads may be damaged when closing the cover.

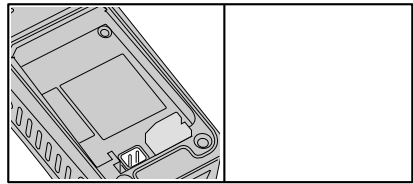

- 3** Close the cover.

- 4** Make sure you charge the new battery for about 15 hours in order to display the battery strength prompt correctly (p. 11).

Adding Another Phone

This unit will not function during a power failure. To connect a standard telephone on the same line, use the Panasonic T-adaptor KX-J66. To order, call the accessories telephone number on page 2.

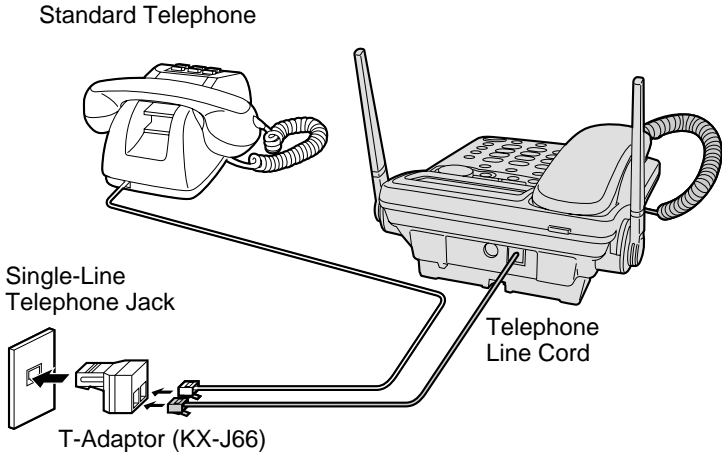

If the Following Appear...



If the unit detects a problem, one of the following messages will be displayed on the cordless handset or the base unit.

Cordless handset display

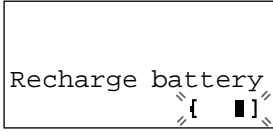

The battery needs to be charged. Place the cordless handset on the charger to charge the battery (p. 12).

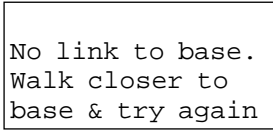

The cordless handset has lost communication with the base unit. Move closer to the base unit and try again.



When trying to store an item or Caller List information in the directory, the directory memory is full (p. 41, 45). To erase other stored items from the directory, see page 51.

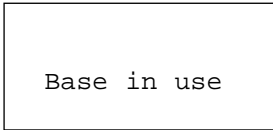

While the base unit was being used, or was pressed to search the Caller List/directory list, was pressed to select an option, or **CLEAR/INTERCOM/HOLD** or **FLASH/CALL WAIT/PLAYBACK** was pressed.

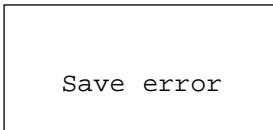

While storing items in the directory, the cordless handset has lost communication with the base unit. Move closer to the base unit and try again.

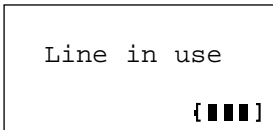

The display will be shown while the base unit is engaged in an outside call.

► If the Following Appear...

Base unit display

12:00AM JAN. 1
0 message

When the clock needs adjusting, the time and date flashes. Adjust the clock (p. 13).

Greeting record
Recording error

Your greeting message was not recorded correctly. Record it again (p. 23).

12:00AM JAN. 1
Message full

If the message memory is full, "Message full" will flash. Erase some, or all, of the messages (p. 65).

Line in use



The display will be shown while the cordless handset is engaged in an outside call.

Portable in use

While the cordless handset was being used, ▼ or ▲ was pressed to search the Caller List/directory list or **FUNCTION/EDIT**, **CLEAR/ERASE**, or **MESSAGE PLAYBACK** was pressed.



Cordless handset

Problem	Cause and Remedy
"No link to base. Walk closer to base & try again" is displayed on the cordless handset display and an alarm tone sounds.	<ul style="list-style-type: none">● You are too far from the base unit. Move closer and try again.● Raise the base unit antennas.● Plug in the AC adaptor of the base unit.● The cordless handset may lose communication with the base unit. Set the security code (p. 60).
Static, sound cuts in/out, fades. Interference from other electrical units.	<ul style="list-style-type: none">● Locate the cordless handset and the base unit away from other electrical appliances (p. 3).● Move closer to the base unit.● Raise the base unit antennas.● Press  to select a clearer channel in the talk, intercom or remote operation mode.
The cordless handset does not ring.	<ul style="list-style-type: none">● The ringer volume is set to OFF. Set to HIGH or LOW (p. 20).
The cordless handset display is blank.	<ul style="list-style-type: none">● Charge the battery fully (p. 11).
You cannot store a name and phone number in the directory.	<ul style="list-style-type: none">● You cannot store an item in the directory while the base unit is in the talk or intercom mode, or while the answering system is in use.● Do not pause for over 60 seconds while storing.
While programming or searching, the unit starts to ring and stops the program/search.	<ul style="list-style-type: none">● To answer the call, press . Start again from the beginning after hanging up.

► Troubleshooting

Problem	Cause and Remedy
The cordless handset does not display the caller's name and/or phone number.	<ul style="list-style-type: none">● You need to subscribe to a Caller ID service.● Other telephone equipment may be interfering with your phone. Disconnect it and try again.● Other electrical appliances connected to the same outlet may be interfering with the Caller ID information.● Telephone line noise may be affecting the Caller ID information.
The cordless handset display exits the Caller List or directory.	<ul style="list-style-type: none">● Do not pause for over 60 seconds while searching.
When a second call is received during a conversation, the cordless handset does not display the new caller's name and/or phone number.	<ul style="list-style-type: none">● The line mode selection is incorrect. See page 16.● The caller requested not to send his/her information. See page 34.
You cannot page the base unit.	<ul style="list-style-type: none">● The cordless handset is too far from the base unit.● The base unit is engaged in an outside call, viewing the Caller List/directory list or listening to messages. Try again later. Wait until "Base in use" disappears.
You cannot redial by pressing REDIAL/PAUSE .	<ul style="list-style-type: none">● If the last number dialed was more than 32 digits long, the number will not be redialed correctly.● The button has a double function as either redial or pause. It will redial the last number dialed if pressed at the outset of a call (p. 29). If another number has been dialed first, it will operate as a pause button (p. 58).



Problem	Cause and Remedy
You cannot have a conversation using the cordless handset.	<ul style="list-style-type: none">● When the optional headset is connected (p. 76), you must use the headset to talk with the caller. To have a normal cordless phone conversation, disconnect the headset.
You cannot have a conversation using the optional headset.	<ul style="list-style-type: none">● Make sure that the headset is connected properly (p. 76).

Base unit

Problem	Cause and Remedy
The base unit does not ring.	<ul style="list-style-type: none">● The ringer volume is set to OFF. Select HIGH or LOW (p. 20).
While programming or searching, the base unit starts to ring and stops the program/search.	<ul style="list-style-type: none">● To answer the call, lift the handset or press DIGITAL SP-PHONE. Start again from the beginning after hanging up.
The base unit does not display the caller's name and/or phone number.	<ul style="list-style-type: none">● You need to subscribe to a Caller ID service.● Other telephone equipment may be interfering with your phone. Disconnect it and try again.● Other electrical appliances connected to the same outlet may be interfering with the Caller ID information.● Telephone line noise may be affecting the Caller ID information.
The base unit display exits the Caller List.	<ul style="list-style-type: none">● Do not pause for over 60 seconds while searching.
When a second call is received during a conversation, the base unit does not display the new caller's information.	<ul style="list-style-type: none">● The line mode selection is incorrect. See page 16.● The caller requested not to send his/her information. See page 34.



► Troubleshooting

Problem	Cause and Remedy
You cannot page a cordless handset.	<ul style="list-style-type: none">●The cordless handset is too far from the base unit.●The cordless handset is engaged in an outside call, viewing the Caller List/directory list or listening to messages. Try again. Wait until “Portable in use” disappears.
You cannot redial by pressing REDIAL .	<ul style="list-style-type: none">●If the last number dialed was more than 32 digits long, the number will not be redialed correctly.

Answering System

Problem	Cause and Remedy
The answering system is on, but incoming messages are not recorded.	<ul style="list-style-type: none">●The recording time is set to “Greeting only”. Select “1 minute”, “2 minutes” or “3 minutes” (p. 26).●Memory is full. Erase some, or all, of the messages (p. 65).
You cannot listen to the recorded messages.	<ul style="list-style-type: none">●Make sure that the unit is not being used.
“Message full” flashes on the base unit display and the ANSWER ON indicator flashes rapidly, and no new messages are recorded.	<ul style="list-style-type: none">●Memory is full. Erase some, or all, of the messages (p. 65).
You cannot operate the answering system with the base unit.	<ul style="list-style-type: none">●The cordless handset user is operating the answering system, or is engaged in an outside call. Wait until “Portable in use” disappears.
Caller ID information does not display during message playback (p. 64).	<ul style="list-style-type: none">●The caller information will not be displayed if the Caller List is renewed and the caller information is erased (p. 42, 43).



Problem	Cause and Remedy
You cannot operate the answering system from a touch tone phone.	<ul style="list-style-type: none">● Make sure you enter the correct remote code.● The answering system may not respond if the tones are too short to activate the unit. Press each button firmly.● The answering system is off. Turn it on (p. 71).
You cannot operate the answering system with the cordless handset.	<ul style="list-style-type: none">● Someone is operating the answering system.● You are too far from the base unit. Move closer to the base unit.● The unit is recording a message. To answer the call, press .
While recording a greeting message, the unit starts to ring and stops recording.	<ul style="list-style-type: none">● To answer the call, press DIGITAL SP-PHONE, lift the handset or press . Start again from the beginning after hanging up.
During playback, the unit starts to ring and stops playback.	<ul style="list-style-type: none">● To answer the call, press DIGITAL SP-PHONE, lift the handset or press .
The base unit does not display the name and/or number of the caller whose message is being played.	<ul style="list-style-type: none">● If the caller is not stored in the Caller List, the base unit will not display the caller's information.

General

Problem	Cause and Remedy
The unit does not work.	<ul style="list-style-type: none">● Check the settings (p. 10–16).● Charge the battery fully (p. 11).● Clean the charge contacts and charge again (p. 12).● Install the battery properly (p. 77).● Place the cordless handset on the charger and unplug the AC adaptor of the base unit to reset. Plug in, and try again.

► Troubleshooting

Problem	Cause and Remedy
You cannot program items, such as the dialing mode.	<ul style="list-style-type: none">● Programming is not possible while the unit is in the talk, speakerphone or intercom mode, when viewing the Caller List/directory list, or while the answering system is in use.● Do not pause for over 60 seconds while programming.● Move closer to the base unit, if you use the cordless handset.● Make sure that the unit is not being used.
Previously programmed information is erased.	<ul style="list-style-type: none">● If a power failure occurs, programmed information may be erased. Reprogram if necessary.
“Recharge battery” is displayed on the cordless handset, “[■]” flashes or the unit beeps intermittently.	<ul style="list-style-type: none">● Charge the battery fully (p. 11).
You charged the battery fully, but “Recharge battery” is still displayed and/or “[■]” continues to flash.	<ul style="list-style-type: none">● Clean the charge contacts and charge again (p. 12).● Install a new battery (p. 77).
If you cannot solve your problem	<ul style="list-style-type: none">● Call our customer call center at 1-800-211-PANA(7262).● Panasonic's e-mail address for customer inquiries: consumerproducts@panasonic.com for customers in the USA or Puerto Rico ONLY

Important Safety Instructions



When using this unit, basic safety precautions should always be followed to reduce the risk of fire, electric shock, or personal injury.

1. Read and understand all instructions.
2. Follow all warnings and instructions marked on this unit.
3. Unplug this unit from AC outlets before cleaning. Do not use liquid or aerosol cleaners. Use a damp cloth for cleaning.
4. Do not use this unit near water, for example, near a bathtub, washbowl, kitchen sink, or the like.
5. Place this unit securely on a stable surface. Serious damage and/or injury may result if the unit falls.
6. Do not cover slots and openings on the unit. They are provided for ventilation and protection against overheating. Never place the unit near radiators, or in a place where proper ventilation is not provided.
7. Use only the power source marked on the unit. If you are not sure of the type of power supplied to your home, consult your dealer or local power company.
8. Do not place objects on the power cord. Install the unit where no one can step or trip on the cord.
9. Do not overload wall outlets and extension cords. This can result in the risk of fire or electric shock.
10. Never push any objects through slots in this unit. This may result in the risk of fire or electric shock. Never spill any liquid on the unit.
11. To reduce the risk of electric shock, do not disassemble this unit. Take the unit to an authorized servicer when service is required. Opening or removing covers may expose you to dangerous voltages or other risks. Incorrect reassembly can cause electric shock when the unit is subsequently used.
12. Unplug this unit from the wall outlet and refer servicing to an authorized servicer when the following conditions occur:
 - A. When the power supply cord or plug is damaged or frayed.
 - B. If liquid has been spilled into the unit.
 - C. If the unit has been exposed to rain or water.
 - D. If the unit does not work normally by following the operating instructions. Adjust only controls covered by the operating instructions. Improper adjustment may require extensive work by an authorized servicer.
 - E. If the unit has been dropped or physically damaged.
 - F. If the unit exhibits a distinct change in performance.
13. During thunderstorms, avoid using telephones except cordless types. There may be a remote risk of an electric shock from lightning.
14. Do not use this unit to report a gas leak, when in the vicinity of the leak.

SAVE THESE INSTRUCTIONS

► Important Safety Instructions

CAUTION:

To reduce the risk of fire or injury to persons, read and follow these instructions.

1. Use only the battery(ies) specified.
2. Do not dispose of the battery(ies) in a fire. They may explode. Check with local waste management codes for special disposal instructions.
3. Do not open or mutilate the battery(ies). Released electrolyte is corrosive and may cause burns or injury to the eyes or skin. The electrolyte may be toxic if swallowed.
4. Exercise care in handling batteries in order not to short the battery to conductive materials such as rings, bracelets, and keys. The battery and/or conductor may overheat and cause burns.
5. Charge the battery(ies) provided with or identified for use with this product only in accordance with the instructions and limitations specified in this manual.

WARNING:

TO PREVENT FIRE OR SHOCK HAZARD, DO NOT EXPOSE THIS PRODUCT TO RAIN OR ANY TYPE OF MOISTURE.

- The AC adaptor is used as the main disconnect device, ensure that the AC outlet is located/installed near the unit and is easily accessible.

FCC and Other Information



This equipment complies with Part 68 of the FCC rules and the requirements adopted by the ACTA. On the bottom of this equipment is a label that contains, among other information, a product identifier in the format US:ACJ-----. If requested, this number must be provided to the telephone company.

Registration No. (found on the bottom of the unit)
Ringer Equivalence No. (REN) 0.1B

A plug and jack used to connect this equipment to the premises wiring and telephone network must comply with the applicable FCC Part 68 rules and requirements adopted by the ACTA. A compliant telephone cord and modular plug is provided with this product. It is designed to be connected to a compatible modular jack that is also compliant.

The REN is used to determine the number of devices that may be connected to a telephone line. Excessive RENs on a telephone line may result in the devices not ringing in response to an incoming call. In most but not all areas, the sum of RENs should not exceed five (5.0). To be certain of the number of devices that may be connected to a line, as determined by the total RENs, contact the local telephone company. For products approved after July 23, 2001, the REN for this product is part of the product identifier that has the format US:AAAEQ##TXXXX. The digits represented by ## are the REN without a decimal point (e.g., 03 is a REN of 0.3).

If this equipment causes harm to the telephone network, the telephone company will notify you in advance that temporary discontinuance of service may be required. But if advance notice isn't practical, the telephone company will notify the customer as soon as possible. Also, you will be advised of your right to file a complaint with the FCC if you believe it is necessary.

The telephone company may make changes in its facilities, equipment, operations or procedures that could affect the operation of the equipment. If this happens the telephone company will provide advance notice in order for you to make necessary modifications to maintain uninterrupted service.

If trouble is experienced with this equipment, for repair or warranty information, please contact a Factory Servicenter or other Authorized Servicer. If the equipment is causing harm to the telephone network, the telephone company may request that you disconnect the equipment until the problem is resolved.

Connection to party line service is subject to state tariffs. Contact the state public utility commission, public service commission or corporation commission for information.

If your home has specially wired alarm equipment connected to the telephone line, ensure the installation of this equipment does not disable your alarm equipment. If you have questions about what will disable alarm equipment, consult your telephone company or a qualified installer.

WHEN PROGRAMMING EMERGENCY NUMBERS AND/OR MAKING TEST CALLS TO EMERGENCY NUMBERS:

- 1) Remain on the line and briefly explain to the dispatcher the reason for the call.
- 2) Perform such activities in the off-peak hours, such as early morning or late evenings.

Useful Information

► FCC and Other Information

This device complies with Part 15 of the FCC Rules. Operation is subject to the following two conditions: (1) This device may not cause harmful interference, and (2) this device must accept any interference received, including interference that may cause undesired operation.

Privacy of communications may not be ensured when using this phone.

CAUTION:

Any changes or modifications not expressly approved by the party responsible for compliance could void the user's authority to operate this device.

Note:

This equipment has been tested and found to comply with the limits for a Class B digital device, pursuant to Part 15 of the FCC Rules. These limits are designed to provide reasonable protection against harmful interference in a residential installation. This equipment generates, uses, and can radiate radio frequency energy and, if not installed and used in accordance with the instructions, may cause harmful interference to radio communications. However, there is no guarantee that interference will not occur in a particular installation. If this equipment does cause harmful interference to radio or television reception, which can be determined by turning the equipment off and on, the user is encouraged to try to correct the interference by one or more of the following measures:

- Reorient or relocate the receiving antenna.
- Increase the separation between the equipment and receiver.
- Connect the equipment into an outlet on a circuit different from that to which the receiver is connected.
- Consult the dealer or an experienced radio/TV technician for help.

Some cordless telephones operate at frequencies that may cause interference to nearby TVs and VCRs. To minimize or prevent such interference, the base of the cordless telephone should not be placed near or on top of a TV or VCR. If interference is experienced, move the cordless telephone further away from the TV or VCR. This will often reduce, or eliminate, interference.

Operating near 2.4GHz electrical appliances may cause interference. Move away from the electrical appliances and/or press the CH (channel) button.

CAUTION:

To comply with FCC RF exposure requirements, the base unit should be installed with its antenna located at 20 cm or more from persons and handset should be carried with the specific belt-clip provided for the handset to ensure compliance. Other non-tested belt-clips or similar body-worn accessories may not comply, therefore, should be avoided.

This equipment is hearing aid compatible as defined by the FCC in 47 CFR Section 68.316.

When you hold the phone to your ear, noise might be heard in your Hearing Aid. Some Hearing Aids are not adequately shielded from external RF (radio frequency) energy. If noise occurs, use an optional headset accessory or the speakerphone option (if applicable) when using this phone. Consult with your audiologist or Hearing Aid manufacturer about the availability of Hearing Aids which provide adequate shielding to RF energy commonly emitted by digital devices.

-
- **Environment**—do not place the unit in a room where the temperature is less than 5°C (41°F) or greater than 40°C (104°F). Allow 10 cm (4") clearance around the unit for proper ventilation. Avoid excessive smoke, dust, mechanical vibration, shock, or direct sunlight.
 - **Medical**—consult the manufacturer of any personal medical devices, such as pacemakers or hearing aids, to determine if they are adequately shielded from external RF (radio frequency) energy. (The unit operates in the frequency range of 2401MHz to 2472MHz and the power output level can range from 0.001 watts to 0.20 watts.) Do not use the unit in health care facilities if any regulations posted in the area instruct you not to do so. Hospitals or health care facilities may be using equipment that could be sensitive to external RF (radio frequency) energy.
 - **Routine care**—wipe the unit with a soft cloth. Do not use benzine, thinner, or any abrasive powder. When you leave the unit unused for a long period of time, unplug the AC adaptor from the outlet.
 - **If there is any trouble**—disconnect the unit from the telephone line and connect a known working phone. If the known working phone operates properly, have your unit repaired by one of the authorized Panasonic Factory Service Centers. If the known working phone does not operate properly, consult your telephone company.

Specifications

■ Base unit

Power Supply:	AC Adaptor (120 V AC, 60 Hz)
Power Consumption:	Standby: Approx. 3.0 W Maximum: Approx. 7.0 W
Frequency:	2.401 GHz – 2.471 GHz
Dimensions (H × W × D):	Approx. 90 mm × 192 mm × 210 mm (3 17/32" × 7 9/16" × 8 1/4")
Mass (Weight):	Approx. 720 g (1.59 lb.)

■ Charger

Power Supply:	AC Adaptor (120 V AC, 60 Hz)
Power Consumption:	Standby: Approx. 1.0 W Maximum: Approx. 4.0 W
Dimensions (H × W × D):	Approx. 73 mm × 94 mm × 101 mm (2 7/8" × 3 11/16" × 3 31/32")
Mass (Weight):	Approx. 160 g (0.35 lb.)

■ Cordless handset

Power Supply:	Ni-Cd battery (3.6 V, 850 mAh)
Frequency:	2.401 GHz – 2.471 GHz
Dimensions (H × W × D):	Approx. 37 mm × 58 mm × 217 mm (1 15/32" × 2 9/32" × 8 17/32")
Mass (Weight):	Approx. 220 g (0.49 lb.)
Security Codes:	1,000,000

■ **Dialing Mode:** Tone (DTMF)/Pulse

■ **Operating Environment:** 5 °C – 40 °C (41 °F – 104 °F)

Speci

**PANASONIC CONSUMER
ELECTRONICS COMPANY, DIVISION
OF MATSUSHITA ELECTRIC
CORPORATION OF AMERICA**
One Panasonic Way
Secaucus, New Jersey 07094

**PANASONIC SALES COMPANY,
DIVISION OF MATSUSHITA
ELECTRIC OF PUERTO RICO, INC.,**
Ave. 65 de Infanteria, Km. 9.5
San Gabriel Industrial Park
Carolina, Puerto Rico 00985

Panasonic Telephone Products Limited Warranty

Limited Warranty Coverage

If your product does not work properly because of a defect in materials or workmanship, Panasonic Consumer Electronics Company or Panasonic Sales Company (collectively referred to as "the warrantor") will, for the length of the period indicated on the chart below, which starts with the date of original purchase ("warranty period"), at its option either (a) repair your product with new or refurbished parts, or (b) replace it with a new or a refurbished product. The decision to repair or replace will be made by the warrantor.

**Parts
One (1) Year**

**Labor
One (1) Year**

During the "Labor" warranty period there will be no charge for labor. During the "Parts" warranty period, there will be no charge for parts. You must mail-in your product during the warranty period. This Limited Warranty excludes both parts and labor for batteries, antennas, and cosmetic parts (cabinet). This warranty only applies to products purchased and serviced in the United States or Puerto Rico. This warranty is extended only to the original purchaser of a new product which was not sold "as is".

Mail-In Service

For assistance in the continental U.S.A. in obtaining repairs please ship the product to:

**Panasonic Services Company
Customer Servicer
Suite B
4900 George McVay Drive
McAllen, TX 78503**

For assistance in Puerto Rico call Panasonic Sales Company (787)-750-4300 or fax (787)-768-2910.

When shipping the unit carefully pack and send it prepaid, adequately insured and preferably in the original carton. Include a letter detailing the complaint and provide a day time phone number where you can be reached.

IF REPAIR IS NEEDED DURING THE WARRANTY PERIOD THE PURCHASER WILL BE REQUIRED TO FURNISH A SALES RECEIPT/PROOF OF PURCHASE INDICATING DATE OF PURCHASE, AMOUNT PAID AND PLACE OF PURCHASE. CUSTOMER WILL BE CHARGED FOR THE REPAIR OF ANY UNIT RECEIVED WITHOUT SUCH PROOF OF PURCHASE.

Limited Warranty Limits And Exclusions

This warranty ONLY COVERS failures due to defects in materials or workmanship, and DOES NOT COVER normal wear and tear or cosmetic damage. The warranty ALSO DOES NOT COVER damages which occurred in shipment, or failures which are caused by products not supplied by the warrantor, or failures which result from accidents, misuse, abuse, neglect, mishandling, misapplication, alteration, faulty installation, set-up adjustments, misadjustment of consumer controls, improper maintenance, power line surge, lightning damage, modification, introduction of sand, humidity or liquids, commercial use such as hotel, office, restaurant, or other business or rental use of the product, or service by anyone other than a Factory Servicer or other Authorized Servicer, or damage that is attributable to acts of God.

THERE ARE NO EXPRESS WARRANTIES EXCEPT AS LISTED UNDER "LIMITED WARRANTY COVERAGE". THE WARRANTOR IS NOT LIABLE FOR INCIDENTAL OR CONSEQUENTIAL DAMAGES RESULTING FROM THE USE OF THIS PRODUCT, OR ARISING OUT OF ANY BREACH OF THIS WARRANTY. (As examples, this excludes damages for lost time, lost calls or messages, cost of having someone remove or re-install an installed unit if applicable, travel to and from the servicer. The items listed are not exclusive, but are for illustration only.) **ALL EXPRESS AND IMPLIED WARRANTIES, INCLUDING THE WARRANTY OF MERCHANTABILITY, ARE LIMITED TO THE PERIOD OF THE LIMITED WARRANTY.**

Some states do not allow the exclusion or limitation of incidental or consequential damages, or limitations on how long an implied warranty lasts, so the exclusions may not apply to you.

This warranty gives you specific legal rights and you may also have other rights which vary from state to state. If a problem with this product develops during or after the warranty period, you may contact your dealer or Servicenter. If the problem is not handled to your satisfaction, then write to the warrantor's Consumer Affairs Department at the addresses listed for the warrantor.

PARTS AND SERVICE, WHICH ARE NOT COVERED BY THIS LIMITED WARRANTY, ARE YOUR RESPONSIBILITY.

Customer Services Directory

***For Product Information, Operating Assistance, Literature Request, Dealer Locations, and all Customer Service inquiries please contact: 1-800-211-PANA (7262), Monday-Friday 9 am-9 pm; Saturday-Sunday 9 am-7 pm, EST.
or send e-mail :
consumerproducts@panasonic.com***

***Web Site: <http://www.panasonic.com>
You can purchase parts, accessories or locate your nearest servicenter by visiting our Web Site.***

Accessory Purchases:

**1-800-332-5368 (Customer Orders Only)
Panasonic Services Company 20421 84th Avenue South, Kent, WA 98032
(6 am to 5 pm Monday - Friday; 6 am to 10:30 am Saturday; PST)
(Visa, MasterCard, Discover Card, American Express, Check)**

***Service in Puerto Rico
Matsushita Electric of Puerto Rico, Inc. Panasonic Sales Company/
Factory Servicenter:
Ave. 65 de Infantería, Km. 9.5, San Gabriel Industrial Park,
Carolina, Puerto Rico 00985
Phone (787)750-4300 Fax (787)768-2910***

Index

A Accessories..... 2	Charger unit11
Answering calls	Corded handset.....10
Base Unit 33	Telephone line cord 10
Cordless Handset 33	Intercom call 54
Auto talk 19, 33	Intercom paging 54
B Backlit LCD 30, 32	L LCD contrast21, 22
Base location..... 3	Lighted cordless handset
Battery, Charge 3, 11	keypad..... 30
Battery information 12	Line mode 16
Battery replacement 77	Listening to
Battery strength..... 11	messages..... 63, 69, 70, 73
Belt Clip 76	Location of controls..... 6, 7, 8, 9
C Call monitoring 62	M Making Calls
Call on hold 30, 32	Base Unit 31
Call waiting caller ID 58	Cordless Handset 28, 29
Call waiting tone..... 58	Message storage time..... 25
Caller ID	Microphone 24, 31, 33, 54
Auto edit feature..... 37, 39	Muting a conversation 57
Caller ID service..... 14, 33, 34	N Noise 3
Caller List	Number of rings..... 27
editing 37, 38	O One-Touch Dialer52
erasing 42, 43	Dialing53
storing 41	Storing.....52
viewing 35	P PAUSE 58
Calling back	Pulse service 57
from Caller ID List 36	R Recording time 26
Command menu 70, 71, 73	Redial 29, 31
Conference call 56	Remote Code 67
D Date and time 13	Remote operation..... 66, 72
Dialing mode 15	Ringer Off 20
Directory 44	Ringer Volume 20
dialing..... 49	Rotary service, tone dialing..... 57
editing..... 50	S Safety Instructions..... 87
erasing 51	Security code setting..... 60
finding..... 47	Shipping product for
name and symbols..... 46	service Back cover
storing 44	Speakerphone 31
Displays 9	Specifications 92
E Erasing a message 65, 70, 73	T Toll saver..... 27
Erasing all messages .. 65, 69, 70, 73	Transferring a call 55
Error messages, base display..... 80	Troubleshooting
Error messages, cordless	Answering System 84
handset display 79	Base Unit 83
F FCC and other information..... 89	Cordless Handset 81
FLASH button..... 59	General 85
Flash time..... 59	V Voice menu 68, 72
Function Menu 17, 18	Volume control
G Greeting, answer setting 61	Base Unit 24, 32, 55, 63
Greeting message..... 23	Cordless Handset 30
H Headset, optional 76	W Wall mounting
Hold alarm..... 30, 32	Base unit 74
I Installation	Charger unit 75
AC adaptor 10	Warranty..... 93
Adding another phone..... 78	

For product service

- Call 1-800-211-PANA(7262) for the location of an authorized servicenter.
- Panasonic's e-mail address for customer inquiries: consumerproducts@panasonic.com for customers in the USA or Puerto Rico ONLY

When you ship the product

- Carefully pack your unit, preferably in the original carton.
- Attach a letter, detailing the symptom, to the outside of the carton.

Symptom

- Send the unit to an authorized servicenter, prepaid and adequately insured.
- Do not send your unit to the Panasonic Consumer Electronics Company listed below or to executive or regional sales offices. These locations do not repair consumer products.

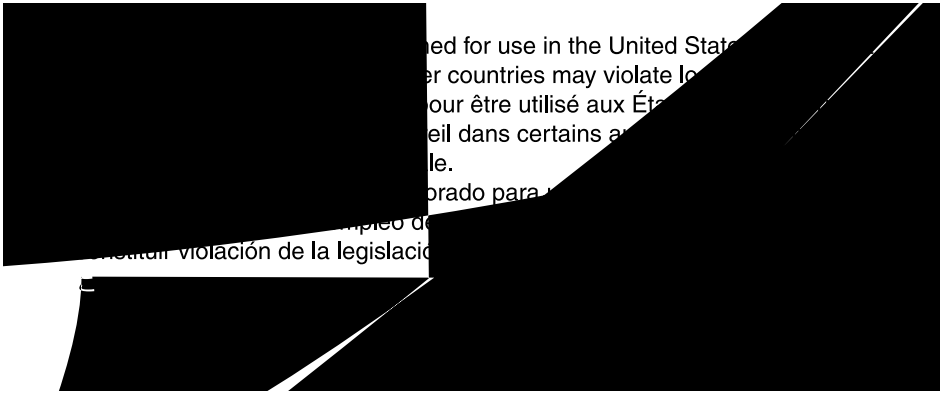

Panasonic Consumer Electronics Company,
Division of Matsushita Electric Corporation of America
One Panasonic Way, Secaucus, New Jersey 07094

Panasonic Sales Company,
Division of Matsushita Electric of Puerto Rico, Inc.
Ave. 65 de Infantería, Km. 9.5, San Gabriel Industrial Park
Carolina, Puerto Rico 00985