

GE Monogram®

Use and Care Guide

Dishwasher

ZBD3500

ZBD3540

ZBD3900

Introduction

Your new Monogram dishwasher makes an eloquent statement of style, convenience and kitchen planning flexibility. Whether you chose it for its purity of design, practical features or assiduous attention to detail—or for all of these reasons—you'll find that your Monogram dishwasher's superior blend of form and function will delight you for years to come.

The information on the following pages will help you operate and maintain your dishwasher properly.

For a listing of dealers—or if you have other questions—in the USA, call the GE Answer Center® 800.626.2000. In Canada, call 1.888.880.3030.

Contents

Appliance Registration	3, 23	Optional Accessories	14
Care and Cleaning	15	Problem Solver	16–18
Consumer Services	3, 20	Safety Instructions	4, 5
Model and Serial Number Location	3	Canada Warranty	23
Operating Instructions	6–13	USA Warranty	24
Control Panel	6, 7		
Display Lights	8		
CleanSensor	9		
Water Temperature	10		
Rinse Agent	10		
Dishwasher Door	10		
Adding a Forgotten Dish to Wash Cycle ..	10		
Detergents	11		
Dishwasher Racks	12, 13		

Before using your dishwasher

Read this guide carefully. It is intended to help you operate and maintain your new dishwasher properly.

Keep it handy for answers to your questions.

If you don't understand something or need more help, call in the USA:

GE Answer Center®,
800.626.2000,
24 hours a day, 7 days a week

In Canada, call 1.888.880.3030.

Write down the model & serial numbers

You can find the model and serial numbers on the tub wall just inside the door.

These numbers are also on the Consumer Product Ownership Registration Card packed separately with your dishwasher.

Before sending in this card, please write these numbers here:

Model Number

Serial Number

Use these numbers in any correspondence or service calls concerning your dishwasher.

If you received a damaged dishwasher

Immediately contact the dealer (or builder) that sold you the dishwasher.

Save time & money

Before you request service, check the Problem Solver in the back of this guide.

It lists causes of minor operating problems that you can correct yourself.

If you need service

To obtain service, see the Consumer Services page in the back of this guide.

We're proud of our service and want you to be pleased. If for some reason you are not happy with the service you receive, here are three steps to follow for further help.

For customers in the USA:

FIRST, contact the people who serviced your appliance. Explain why you are not pleased. In most cases, this will solve the problem.

NEXT, if you are still not pleased, write all the details—including your phone number—to:

Manager, Customer Relations
GE Appliances
Appliance Park
Louisville, KY 40225

FINALLY, if your problem is still not resolved, write:

Major Appliance Consumer
Action Program
20 North Wacker Drive
Chicago, IL 60606

For customers in Canada:

FIRST, contact the people who serviced your appliance. Explain why you are not pleased. In most cases, this will solve the problem.

NEXT, if you are still not pleased, write all the details—including your phone number—to:

Manager, Consumer Relations
Camco Inc.
1 Factory Lane, Suite 310
Moncton, N.B. E1C 9M3

IMPORTANT SAFETY INSTRUCTIONS

▲ WARNING!

For your safety, the information in this guide must be followed to minimize the risk of fire, explosion, electric shock, or to prevent property damage, personal injury, or loss of life.

- Do not tamper with controls.
- Do not abuse, sit on, or stand on the door or dish rack of the dishwasher.
- Do not discard a dishwasher without first removing the door of the washing compartment.
- Do not store or use combustible materials, gasoline or other flammable vapors and liquids in the vicinity of this or any other appliance.
- Do not allow children to play inside, on or with this appliance or any discarded appliance.

WATER HEATER SAFETY

Under certain conditions hydrogen gas may be produced in a water heater that has not been used for two weeks or more. HYDROGEN GAS IS EXPLOSIVE.

If the hot water has not been used for two weeks or more, prevent the possibility of damage or injury by turning on all hot water faucets and allowing them to run for several minutes. Do this before using any electrical appliance which is connected to the hot water system. This simple procedure will allow any built-up hydrogen gas to escape. Since the gas is flammable, do not smoke or use an open flame or appliance during this process.

PROPER INSTALLATION AND MAINTENANCE

This dishwasher must be properly installed and located in accordance with the Installation Instructions before it is used. If you did not receive an Installation Instructions sheet with your dishwasher, you can receive one by calling us toll-free in the USA, at the GE Answer Center®, 800.626.2000. In Canada, call 1.888.880.3030.

- Connect to a grounded metal, permanent wiring system; or run an equipment-grounding conductor with the circuit conductors and connect to the equipment-grounding terminal or lead of the appliance.
- Improper connection of the equipment-grounding conductor can result in a risk of electric shock. Check with a qualified electrician or service representative if you are in doubt whether the appliance is properly grounded.
- Dispose of discarded appliances and shipping or packing material properly.
- Do not attempt to repair or replace any part of your dishwasher unless it is specifically recommended in this manual. All other servicing should be referred to a qualified technician.
- To minimize the possibility of electric shock, disconnect this appliance from the power supply before attempting any maintenance. **NOTE:** Turning the dishwasher off does not disconnect the appliance from the power supply. We recommend having a qualified technician service your appliance.

WHEN USING YOUR DISHWASHER

Use this appliance only for its intended purpose as described in this Owner's Guide.

- Use only powder, tabs or liquid detergents or wetting agents recommended for use in a dishwasher and keep them out of the reach of children.
- Locate sharp items so that they are not likely to damage the door seal.
- Load sharp knives with the handles up to reduce the risk of cut-type injuries.
- Do not wash plastic items unless marked *dishwasher safe* or the equivalent. For plastic items not so marked, check the manufacturer's recommendations.
- Non-Dishware Items: Do not wash items such as electronic air cleaner filters, furnace filters and paint brushes in your dishwasher. Damage to dishwasher and discoloration or staining of dishwasher may result.
- Do not touch the heating element during or immediately after use.
- Do not operate your dishwasher unless all enclosure panels are properly in place.
- Close supervision is necessary if this appliance is used by or near children.
- Load light plastic items so they will not become dislodged and drop to the bottom of the dishwasher—they might come into contact with the heating element and be damaged.

Read and follow this Safety Information carefully.
SAVE THESE INSTRUCTIONS

You can locate your model number on the tub wall just inside the door. Throughout this manual, features and appearance may vary from your model.

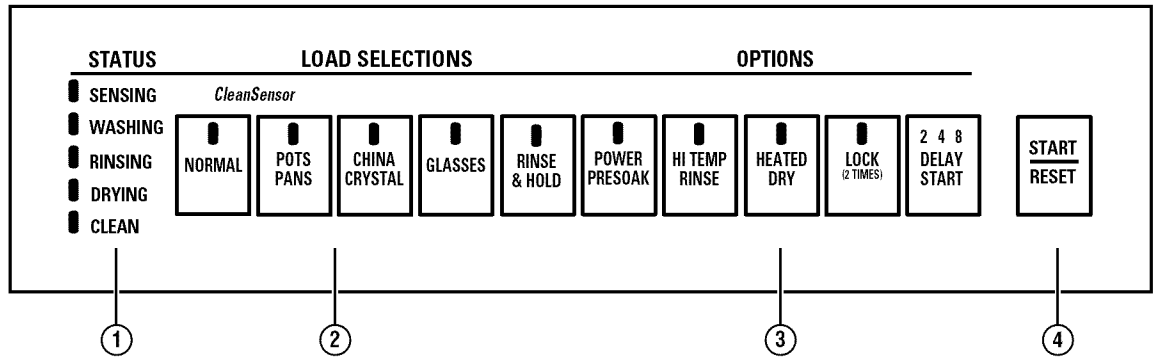

Control Settings

1. The Status

The Status display tells you what's happening while the dishwasher is in operation and also any malfunctions if they occur. The lights will come *ON* indicating the sequence of operation the dishwasher is in.

SENSING	Displayed during periods using CLEANSENSOR technology to measure the amount of soil in the load and decide if another prewash is needed.
WASHING	Displayed during prewash and main wash periods.
RINSING	Displayed during rinse periods.
DRYING	Displayed during HEATED DRY.
CLEAN	Displayed when cycle is complete. Light remains <i>ON</i> until door is opened.

2. Load Selections

The light above the selected pad will be *ON* to indicate which **LOAD SELECTION** has been selected.

NORMAL	For loads of everyday dishes, glasses and cookware with medium soils.
POTS PANS	For heavily soiled dishes or cookware with dried-on or baked-on soils. Everyday dishes may be included. This cycle will not remove burned-on foods.
CHINA CRYSTAL	For lightly soiled china and crystal.
GLASSES	For loads of glassware. Especially good to reduce spotting and filming.
RINSE & HOLD	For rinsing partial loads that will be washed later. Do not use detergent with this cycle.

3. Options

The light above the selected pad will be *ON* to indicate which *OPTION* has been selected.

POWER PRESOAK	For use with heavily soiled and/or dried-on, baked-on soils. This option MUST be selected PRIOR to starting the cycle. This option adds 16 minutes to the cycle time.
HI TEMP RINSE	Turns on the heater in all prerinse and final rinse cycles to help prevent spotting on dishware. This option may be turned <i>ON</i> or <i>OFF</i> during the wash cycle.
HEATED DRY OFF	Shuts off the drying heat options. Dishes air dry naturally and energy is saved. You can prop the door open after the light goes <i>ON</i> next to the word CLEAN which appears in the STATUS display for faster drying.
HEATED DRY ON	Turns the heater on for fast drying. This cycle will extend the time to your wash cycle by 30 minutes. NOTE: Cannot be selected with RINSE & HOLD cycle.
LOCK	When the LOCK pad is touched twice within 3 seconds, all pads become inoperative. You can lock the controls to prevent any selections from being made. Or you can lock the controls after you have started a cycle or selected DELAY START so the cycle or DELAY START is not interrupted. Children cannot accidentally start dishwasher by touching pads with this option selected. To unlock the dishwasher after it has been locked, touch the LOCK pad twice within 3 seconds. The light above the LOCK pad will be off.
DELAY START	You can delay the start of a wash cycle for up to 8 hours. Press and hold the DELAY START pad to choose the number of hours you want to delay the start of the cycle. The machine will count down and start automatically at the correct time. NOTE: If you forget to lock the door a reminder signal will beep until you do so.
RESET	To change a cycle after washing starts, touch the START/RESET pad to cancel the cycle. After water is pumped out and motor stops, you can reprogram and restart the dishwasher.

4. Start

Close the door until it locks into place and touch the **START/RESET** pad to begin the cycle. There is a time delay between start-up and water fill so you will not hear any wash action right away.

The cycle is complete when the light is *ON* next to the word **CLEAN** in the **STATUS** display.





















NOTE: The dishwasher remembers your last cycle so you don't have to reprogram each time. When the dishwasher is loaded and door latch is in the locked position, the control panel lights will be on and display the last settings you selected.

If you don't want to change any of the settings, simply touch the **START/RESET** pad to begin the cycle.

Also, if a power failure occurs, **NORMAL** and **HEATED DRY** will automatically be programmed. Make any new selections and touch the **START/RESET** pad to begin the cycle.

Flashing Display Lights

Dishwasher

System Lights	What It Means	What To Do
<p>STATUS  SENSING  WASHING  RINSING  DRYING  CLEAN</p>	CLEANSENSOR Error	<p>If the sensing light does not come on at the beginning of the NORMAL or POTS PANS cycle, the CLEANSENSOR is not working. Call for service. The dishwasher will continue to work without the CLEANSENSOR.</p> <p>NOTE: This light will not stay on the entire cycle.</p>
<p>STATUS  SENSING  WASHING  RINSING  DRYING  CLEAN</p>	START/RESET pad has been pressed	Allow dishwasher to drain and reset before selecting a new cycle.
<p>STATUS  SENSING  WASHING  RINSING  DRYING  CLEAN</p> <p>PLUS A BEEPING SOUND</p>	Control Error	Press the START/RESET pad to turn off the beeper. But the rinsing light will continue to flash. If this continues, call for service.
<p>STATUS  SENSING  WASHING  RINSING  DRYING  CLEAN</p> <p>PLUS A BEEPING SOUND</p>	Control Error	Press the START/RESET pad to turn off the beeper and the dishwasher will attempt to reset. Then restart the wash cycle. If this error continues, call for service.

The CleanSensor

Dishwasher

The dishwasher has an exclusive CleanSensor System that measures the amount of soil in the load and determines the number of prewashes needed to clean the dishes.

CYCLE	SOIL LEVEL	CYCLE SEQUENCES						WATER USAGE GALLONS	TOTAL TIME MINUTES	
Normal	Heavy	PreWash	PreWash	PreWash	Main Wash	PreRinse	PreRinse	Final Rinse	10.5	66
Normal	Medium	PreWash	PreWash		Main Wash	PreRinse	PreRinse	Final Rinse	9	62
Normal	Light	PreWash			Main Wash	PreRinse	PreRinse	Final Rinse	7.5	58
Pots Pans	Extra Heavy	PreWash	PreWash	PreWash	PreWash	Main Wash	PreRinse	Final Rinse	10.5	66-81
Pots Pans	Heavy	PreWash	PreWash	PreWash		Main Wash	PreRinse	Final Rinse	9	62
Pots Pans	Medium	PreWash	PreWash			Main Wash	PreRinse	Final Rinse	7.5	58
China Crystal		PreWash				Main Wash	PreRinse	Final Rinse	6.1	33
Glasses						Main Wash	Main Wash	Final Rinse	4.6	31
Rinse & Hold								Rinse	1.5	5

Water Temperature

The entering water must be at least 120°F. and not more than 150°F., for effective cleaning and to prevent dish damage. Check the water temperature with a candy or meat thermometer. Turn on the hot water faucet nearest the dishwasher, place the thermometer in a glass and let the water run continuously into the glass until the temperature stops rising.

Use Jet-Dry® Rinse Agent

JET-DRY® rinse agent removes spots and prevents new film build-up on your dishes, glasses, flatware, cookware and plastic.

Fill the rinse agent dispenser until it reaches the bottom of lip inside the opening. Replace the cap.

To check if rinse agent is needed, remove the cap and look into the dispenser.

- A full dispenser should last about one month.
- If rinse agent spills, wipe it up immediately. It can keep your detergent from working.

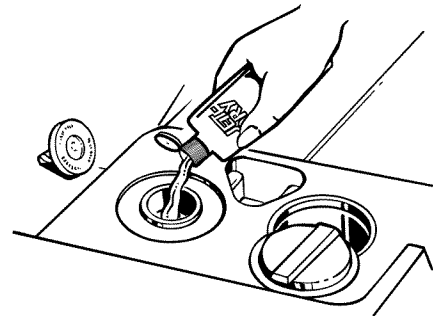

Dishwasher Door

1. The door must be closed and locked into place to select a LOAD SELECTION or an OPTION.
2. If the door is opened during a cycle and left open, *the dishwasher will beep once every minute* until the door is closed and latched into place.

Adding a Forgotten Dish

A forgotten dish can be added any time before the detergent cup opens.

1. Push the door latch to the left.
2. Do not open the door until the water spray action stops. Steam may rise out of the dishwasher.
3. Add forgotten dishes.
4. Close the door and push the latch to the far right.

Detergents

Use only detergent specifically made for use in dishwashers. Keep your detergent fresh and dry. Don't put powder detergent into the dispenser until you're ready to wash dishes.

The amount of detergent to use depends on whether your water is hard or soft. With hard water, you need extra detergent. With soft water, you need less detergent.

Protect your dishes and dishwasher by contacting your water department and asking how hard your water is. Twelve or more grains is extremely hard water. A water softener is recommended. Without it, lime can build up in the water valve, which could stick while open and cause flooding. Too much detergent with soft water can cause a permanent cloudiness of glassware, called etching.

You'll find two detergent dispensers on the inside door of your dishwasher. All wash cycles require detergent in the main cup. Wash cycles with two washes will also use the open cup. When using automatic dishwashing detergent tabs, simply place one tab in the main cup and close.

Be sure the control panel lights are not lit before adding detergent. Otherwise, the detergent cup will not close and latch properly. Add detergent then close the main cup.

NOTE: To open detergent cup after it has been closed, simply turn the detergent cup handle counter-clockwise until it releases. A snapping sound may be heard.

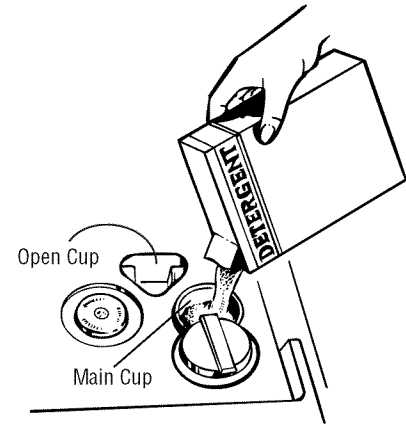

Loading the Racks

Dishwasher

Upper Rack

The upper rack is for glasses, cups and saucers. Cups and glasses fit best along the sides. This is also a secure place for dishwasher-safe plastics.

The cup shelf (on some models) may be placed in the up or down position to add flexibility. A wine glass holder (on some models) secures wine glasses at an angle for best washability. Because wine glasses come in various sizes, after loading, slowly push in the rack to make sure they will clear the top of the dishwasher.

The upper rack is good for all kinds of odd-shaped utensils. Saucepans, mixing bowls and other items should be placed face down.

Secure larger dishwasher-safe plastics over two fingers when possible.

Make sure small plastic items are secure so they can't fall onto the heating element.

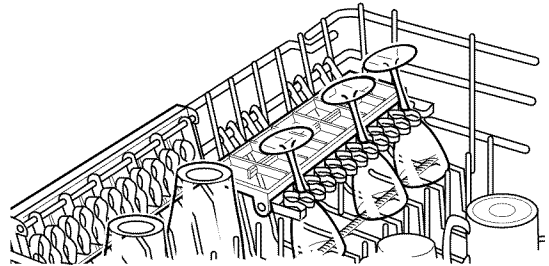

Wash Tower

Keep the center area clear in the lower rack.

The wash tower rises through the center of the lower rack during the wash and rinse portions of the cycle.

A second wash tower is located in the top rack. Water from the wash tower in the lower rack shoots up into this wash tower and out the openings at the top. When loading items around this wash tower do not block the top openings.

Don't block it or load tall things next to it.

Also, be careful not to let a portion of an item such as a pot or dish handle extend through the bottom rack. This could block the wash arm and cause poor washing results.

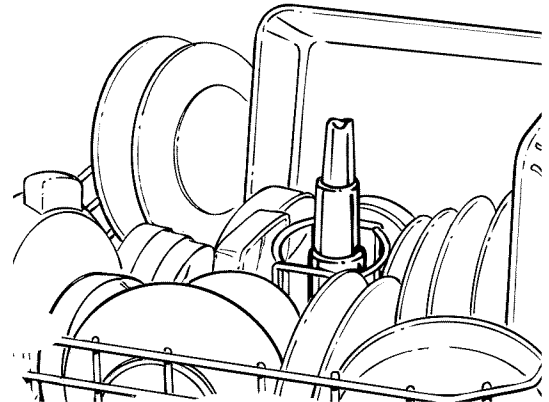

Lower Rack

When loading the lower rack, do not load large platters or trays in the front right corner. They may prevent detergent from circulating during the wash cycle.

The lower rack is best used for plates, saucers, and cookware. Large items such as broiler pans and racks should go along the sides. Load platters, pots and bowls along the sides, in corners, or in the back. The soiled side of items should face the center of the rack.

Fold-down fingers provide flexibility for extra large and hard-to-fit items.

The fingers may be left in the up position or folded down to customize the lower rack.



Silverware Basket

Put flatware in the removable basket with fork and knife handles up to protect your hands. Place spoons in the basket with handles down. Mix knives, forks and spoons so they don't nest together. Distribute evenly. Small plastic items, such as measuring spoons and lids from small containers, should go in the bottom of the silverware basket with silverware on top.

To increase the flexibility of the lower rack, the silverware basket may be split. Grasp the basket at opposite corners and slide apart. The basket sections should be placed in the lower rack by hanging them on the top hoop.

A cover can be lowered to either side to secure lightweight items from the effects of the vigorous wash action.

The accessory basket can hold small items such as: baby bottle nipples, plastic lids, corn cob holders, etc. It can hang from the top hoop of the upper rack along the right side or it can also hang on the right or left side of the lower rack. When hanging the accessory basket on the right side in the upper rack make sure the top is closed and nothing is sticking out.

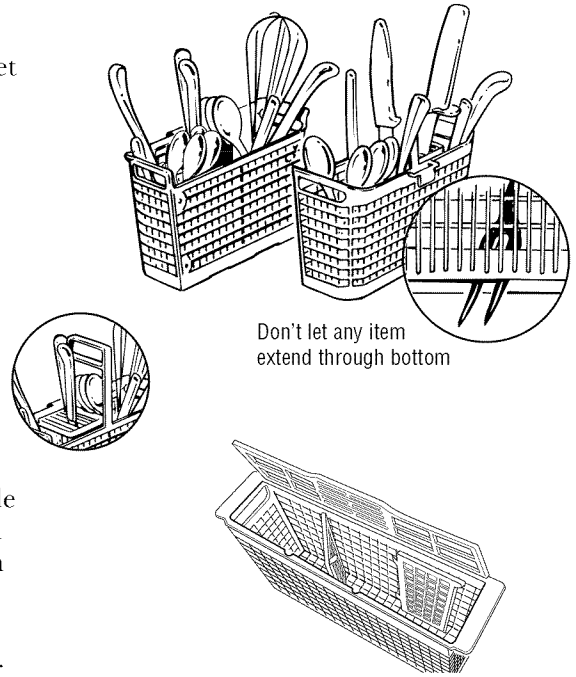

Follow these guidelines for loading 10 place settings

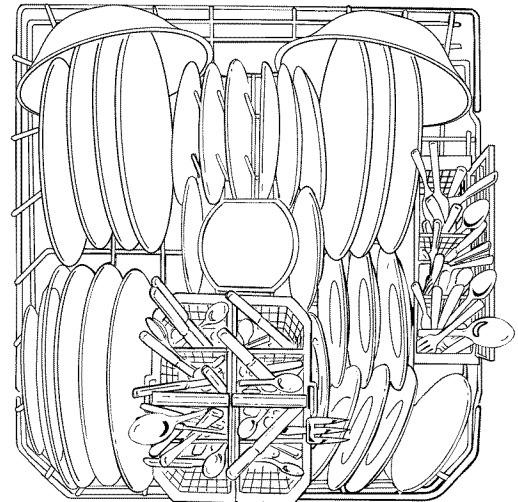
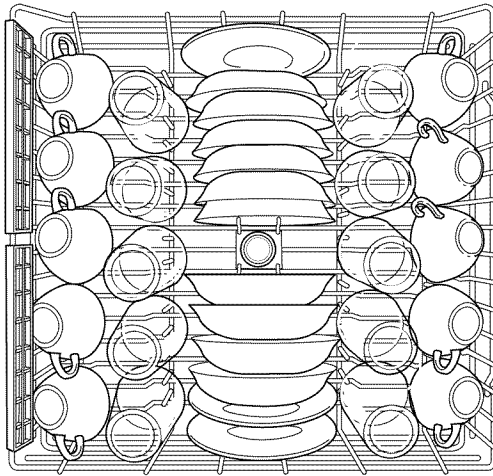

Follow these guidelines for loading 12 place settings

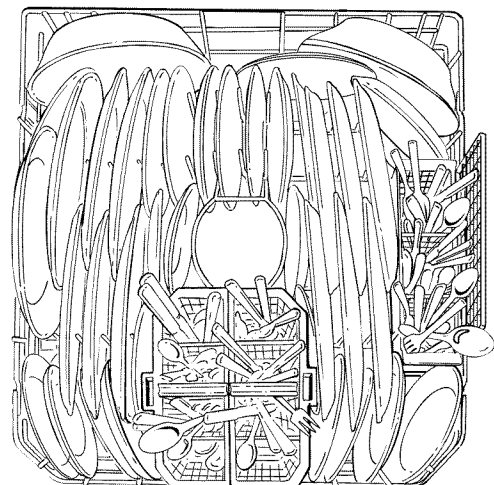
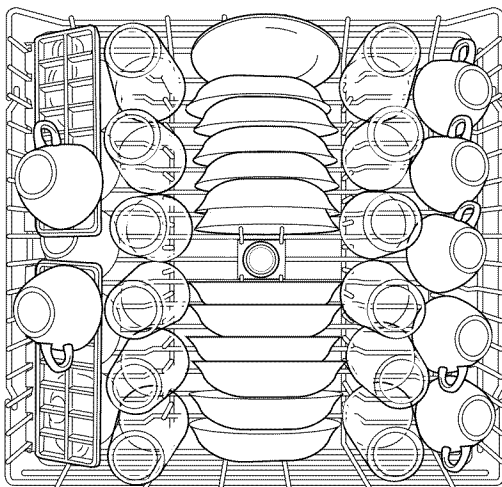

Optional Accessories

Dishwasher

Change the Dishwasher's Appearance

You can change the door and lower access panel appearance of your dishwasher, except model ZBD3900, by ordering one of these optional accessories:

- Stainless Steel Panels
- 1/4" Wood Panel Trim Kit
- 3/4" Trimless Panel Kit

These accessories are available at extra cost (Visa, MasterCard, or Discover cards accepted) by calling in the USA, 800.626.2002. In Canada, call 1.888.880.3030.

Specify accessory number when ordering.

Descriptions of Optional Accessories

Door panels— Replacement door panels and lower access panels are available in Stainless Steel. Order GPF400S.

NOTE: The GPF100 dishwasher door spring kit will be included with the stainless steel panel and must be installed with it.

Wood panel trim kit— This accessory contains trim and instructions for you to supply and install a 1/4" thick decorative wood door and lower access panel:

- GPF425B (Black)
- GPF425W (White)

NOTE: The GPF100 dishwasher door spring kit must also be ordered and installed when the door panel weighs four lbs. or more.

Trimless panel kit— This accessory contains parts and instructions for you to supply and install a 3/4" thick decorative wood door and lower access panel:

- GPF475

NOTE: The GPF100 dishwasher door spring kit will be included with the trimless panel kit and must be installed with it.

Control Panel

To clean the control panel use a lightly dampened cloth then dry thoroughly. To clean the exterior use a good appliance polish wax.

Never use sharp objects, scouring pads or harsh cleaners on any part of the dishwasher.

The stainless steel control panels can be cleaned with Stainless Steel Magic or a similar product using a clean, soft cloth.

You can order Stainless Steel Magic # WX10X15 through GE Parts in the USA, by calling 800.626.2002. In Canada, call 1.888.880.3030.

Protect Against Freezing

If your dishwasher is left in an unheated place during the winter, ask a service technician to:

1. Cut off electrical power to the dishwasher. Remove fuses or trip circuit breaker.
2. Turn off the water supply and disconnect the water inlet line from the water valve.
3. Drain water from the water inlet line and water valve. (Use a pan to catch the water.)
4. Reconnect the water inlet line to the water valve.
5. Remove the plastic sump cover in the tub bottom and use a sponge to soak up water in the rubber boot.

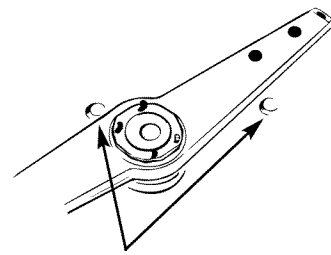

Sump cover screws

The Air Gap

An air gap protects your dishwasher against water backing up into it if a drain clogs. The air gap is not a part of the dishwasher. It is not covered by your warranty. Not all plumbing codes require air gaps, so you may not have one.

The air gap is easy to clean.

1. Turn off the dishwasher and lift off the chrome cover.
2. Unscrew the plastic cap and clean with a toothpick.

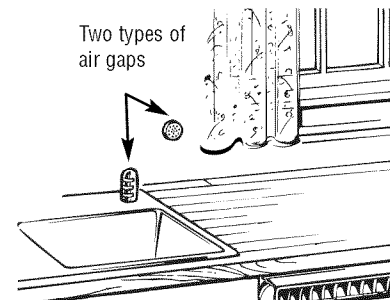

Check the air gap any time your dishwasher isn't draining well.

Caring for GPF400S Optional Accessory

The stainless steel panels can be cleaned with Stainless Steel Magic or a similar product using a clean, soft cloth.

You can order Stainless Steel Magic # WX10X15 through GE Parts in the USA, by calling 800.626.2002. In Canada, call 1.888.880.3030.

Before You Call For Service

Dishwasher

*Questions?
Use this
problem
solver*

PROBLEM	POSSIBLE CAUSE	WHAT TO DO
Control panel lights go off when you're setting the dishwasher	Time too long between touching of selected pads	<ul style="list-style-type: none"> · Each pad must be touched within 30 seconds of the other controls. To relight, touch any pad again, or unlock and relatch door.
Noise	Some of the sounds you'll hear are normal	<ul style="list-style-type: none"> · Soft food disposal shredding action. · Drain valve opening to pump water out. · Timer control as cycle progresses. · Detergent cup opening. · The motor stopping during the drying period. · Water draining out of the tub immediately after you touch START/RESET pad.
	Utensils are not secure in the rack or something small has dropped into the rack	<ul style="list-style-type: none"> · Make sure everything is secured in dishwasher.
	Motor hums	<ul style="list-style-type: none"> · Dishwasher has not been used on a regular basis. If you do not use your dishwasher often, set it to fill and pump out once every week. This will help keep the seal moist and the garbage disposer clear.
Detergent left in dispenser cups	Dishes are blocking the detergent cups	<ul style="list-style-type: none"> · Reposition the dishes.
Detergent cup lid latched accidentally by user		<ul style="list-style-type: none"> · Open the door and press the START/RESET pad three times within two seconds. The detergent cup will trip.
Water standing in the bottom of the tub	This is normal	<ul style="list-style-type: none"> · A small amount of clean water around the outlet on the tub bottom at the back of the tub keeps the water seal lubricated.
Water won't pump out of the tub	Drain is clogged	<ul style="list-style-type: none"> · If you have an air gap, clean it. · Check to see if your kitchen sink is draining well. If not, you may need a plumber. · If the dishwasher drains into a disposer, run disposer clear.
Suds in the tub	Correct detergent wasn't used	<ul style="list-style-type: none"> · Use only automatic dishwasher detergents to avoid sudsing. · To remove suds from the tub, open the dishwasher and let suds evaporate. Add 1 gallon of cold water to the tub. Close the door until it locks into place. Pump out water by pressing START/RESET, then immediately press START/RESET again. Repeat if necessary.
	Rinse agent was spilled	<ul style="list-style-type: none"> · Always wipe up rinse agent spills immediately.

Questions?
Use this
problem
solver

PROBLEM	POSSIBLE CAUSE	WHAT TO DO
Stained tub interior	Detergent with colorant was used	<ul style="list-style-type: none"> Some detergents contain colorant (pigment or dyes) that will discolor the tub interior with extended use. Check the detergent cup for signs of any discoloration. If cup is discolored, change to detergent without any colorant.
	Some tomato-based foods can stain	<ul style="list-style-type: none"> Use of the RINSE & HOLD cycle (on some models) after adding the dish to the load can decrease the level of staining.
Dishes and flatware not clean	Inlet water temperature is below 120°F.	<ul style="list-style-type: none"> Raise the water heater temperature to 120°F. Use HI TEMP WASH.
	Water pressure is temporarily low	<ul style="list-style-type: none"> Turn on a faucet. Is water coming out more slowly than usual? If so, wait until pressure is normal before using your dishwasher.
	Air gap is clogged	<ul style="list-style-type: none"> Clean the air gap.
	Improper rack loading	<ul style="list-style-type: none"> Make sure large dishware does not block the detergent dispenser or the wash arm.
Spots and filming on glasses and flatware	Extremely hard water	<ul style="list-style-type: none"> Use JET-DRY® rinse agent to remove spots and prevent new film build-up.
	Low inlet water temperature	<ul style="list-style-type: none"> To remove stubborn spots from glassware: <ol style="list-style-type: none"> 1 Remove all metal utensils from the dishwasher. 2 Do not add detergent. 3 Select the POT PANS cycle and HEATED DRY option. 4 Start the dishwasher and allow to run for 26 minutes. Dishwasher will now be in the main wash. 5 Open the door and pour 2 cups (500 ml) of white vinegar into the bottom of the dishwasher. 6 Close the door and allow to complete the cycle. If vinegar rinse doesn't work: Repeat as above, except use 1/4 cup (60 ml) of citric acid crystals instead of vinegar.
	Overloading the dishwasher	
	Improper loading	
	Old or damp powder detergent	
	Rinse agent dispenser empty	
Too little detergent		

Before You Call For Service

Dishwasher

*Questions?
Use this
problem
solver*

PROBLEM	POSSIBLE CAUSE	WHAT TO DO
Cloudiness on glassware	Combination of soft water and too much detergent	·This is called etching and is permanent. To prevent this from happening, use less detergent if you have soft water. Wash glassware in the shortest cycle that will get them clean.
	Water temperature entering the dishwasher exceeds 150°F.	·Lower the water heater temperature.
Black or gray marks on dishes	Aluminum utensils have rubbed against dishes	·Remove marks with a mild, abrasive cleaner.
Yellow or brown film on inside surfaces	Tea or coffee stains	·Remove the stain by hand, using a solution of 1/2 cup bleach and 3 cups warm water. ▲WARNING Before cleaning interior wait at least 20 minutes after a cycle for the heating element to cool down. Failure to do so can result in burns.
	An overall yellow or brown film can be caused by iron deposits in water	·A special filter in the water supply line is the only way to correct this problem. Contact a water softener company.
White film on inside surfaces	Hard water minerals	·To clean the interior, apply dishwasher detergent to a damp sponge. Wear rubber gloves. Do not use any type of cleanser other than dishwasher detergent because it may cause foaming or sudsing.
Dishes don't dry	Low inlet water temperature	·Make sure inlet water temperature is correct. ·Select HI TEMP RINSE and/or HEATED DRY Option.
	Rinse agent dispenser is empty	·Check the rinse agent dispenser.
Control panel responded to inputs but dishwasher never filled with water	Door latch may not be properly seated	·Call for service.
Dishwasher won't run	Fuse is blown, or the circuit breaker tripped	·Replace fuse or reset circuit breaker. Remove any other appliances from the circuit. ·Try resetting the START/RESET pad.
Steam	This is normal	·Steam comes through the vent by the door latch during drying and when water is being pumped out.

With the purchase of your new Monogram appliance, receive the assurance that if you ever need information or assistance from GE, we'll be there. All you have to do is call—toll-free!

GE Answer Center[®]

**In the USA:
800.626.2000**

Whatever your question about any Monogram major appliance, GE Answer Center[®] information service is available to help. Your call—and your question—will be answered promptly and courteously. And you can call any time. GE Answer Center[®] service is open 24 hours a day, 7 days a week.

In Canada, call 1.888.880.3030.

In-Home Repair Service

**In the USA:
800.444.1845**

**In Canada:
1.888.880.3030**

A GE consumer service professional will provide expert repair service, scheduled at a time that's convenient for you. Many GE Consumer Service company-operated locations offer you service today or tomorrow, or at your convenience (7:00 a.m. to 7:00 p.m. weekdays, 9:00 a.m. to 2:00 p.m. Saturdays). Our factory-trained technicians know your appliance inside and out—so most repairs can be handled in just one visit.

For Customers With Special Needs...

**In the USA:
800.626.2000**

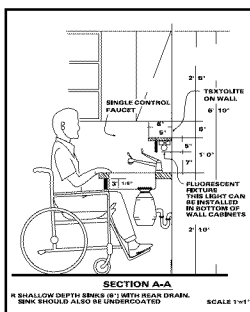

GE offers Braille controls for a variety of GE appliances, and a brochure to assist in planning a barrier-free kitchen for persons with limited mobility.

Consumers with impaired hearing or speech who have access to a TDD or a conventional teletypewriter may call 800.TDD.GEAC (800.833.4322) to request information or service.

Service Contracts

**In the USA:
800.626.2224**

**In Canada:
1.888.880.3030**

You can have the secure feeling that GE Consumer Service will still be there after your warranty expires. Purchase a GE contract while your warranty is still in effect and you'll receive a substantial discount. With a multiple-year contract, you're assured of future service at today's prices.

Parts and Accessories

**In the USA:
800.626.2002**

**In Canada:
1.888.880.3030**

Individuals qualified to service their own appliances can have parts or accessories sent directly to their home. The GE parts system provides access to over 47,000 parts...and all GE Genuine Renewal Parts are fully warranted. VISA, MasterCard and Discover cards are accepted.

User maintenance instructions contained in this guide cover procedures intended to be performed by any user. Other servicing generally should be referred to qualified service personnel. Caution must be exercised, since improper servicing may cause unsafe operation.

**Consumer Product
Ownership Registration**
Important Mail Today

GE Appliances



Place
1st Class
Letter
Stamp
Here

General Electric Company
Warranty Registration Department
P.O. Box 34070
Louisville, KY 40232-4070

Consumer Product Ownership Registration

Dear Customer:

Thank you for purchasing our product and thank you for placing your confidence in us. We are proud to have you as a customer!

Follow these three steps to protect your new appliance investment:

1 Complete and mail your Consumer Product Ownership Registration today. Have the peace of mind of knowing we can contact you in the unlikely event of a safety modification.

2 After completing this registration, write your model and serial numbers in this guide. You will need this information should you require service. The service number in the USA: 800.444.1845. In Canada: 1.888.880.3030.

3 Read your Use and Care Guide carefully. It will help you operate your new appliance properly. If you have questions, or need more information, in the USA, call the GE Answer Center® 800.626.2000. In Canada, call 1.888.880.3030.

Important: To ensure that your product is registered, mail the separate product registration card. If the separate card is missing, fold and mail this form. No envelope is needed.

Consumer Product Ownership Registration



Product
Dishwasher

Model No.

Serial No.

Mr. Ms. Mrs. Miss

First Name _____ Last Name _____

Street Address _____

Apt. # _____

City _____ State _____ Zip Code _____

Date Placed In Use Month _____ Day _____ Year _____ Phone Number _____-_____-_____



TAPE CLOSED



YOUR MONOGRAM DISHWASHER WARRANTY

Staple sales slip or cancelled check here. Proof of original purchase date is needed to obtain service under warranty.

WHAT IS COVERED

From the Date of the Original Purchase

ONE-YEAR

Any part of the dishwasher which fails due to a defect in materials or workmanship. During this full one-year warranty, GE will also provide, free of charge, all labor and in-home service to replace the defective part.

Second Year

Any part of the dishwasher which fails due to a defect in materials or workmanship. During this second-year limited warranty, you will be responsible for any labor or in-home service costs.

Five Years

The dishwasher rack, if it should rust, or the electronic control module if it should fail due to a defect in materials or workmanship. During this five-year limited warranty, you will be responsible for any labor or in-home service costs.

Twenty Years

The PermaTuf® tub or door liner, if it fails to contain water due to a defect in materials or workmanship. During this full twenty-year warranty, GE will also provide, free of charge, all labor and in-home service to replace the defective part.



This warranty is extended to the original purchaser and any succeeding owner for products purchased for ordinary home use in Canada.

All warranty service will be provided by our Factory Service Centers or by our authorized Customer Care® servicers during normal working hours.

Should your appliance need service, during warranty period or beyond, call 1.888.880.3030.

WHAT IS NOT COVERED

• Service trips to your home to teach you how to use the product.

Read your Use and Care material.

If you then have any questions about operating the product, please contact your dealer or our Consumer Relations office at the address below, or call, toll free:

1.888.880.3030

- Improper installation.
- Replacement of house fuses or resetting of circuit breakers.
- Failure of the product if it is abused, misused, or used for other than the intended purpose or used commercially.

• Damage to product caused by accident, fire, floods or acts of God.

• Incidental or consequential damage to personal property caused by possible defects with this appliance.

• Cleaning or servicing of the air gap device in the drain line.

WARRANTOR IS NOT RESPONSIBLE FOR CONSEQUENTIAL DAMAGES.

Some provinces do not allow the exclusion or limitation of incidental or consequential damages, so the above limitation or exclusion may not apply to you. This warranty gives you specific legal rights, and you may also have other rights which vary from province to province. To know what your legal rights are in your province, consult your local or provincial consumer affairs office.

Warrantor: Camco Inc. If further help is needed concerning this warranty, write: Manager, Consumer Relations, Camco Inc., 1 Factory Lane, Suite 310, Moncton, N.B. E1C 9M3.

YOUR MONOGRAM DISHWASHER WARRANTY

Staple sales slip or cancelled check here. Proof of original purchase date is needed to obtain service under warranty.

WHAT IS COVERED

From the Date of the Original Purchase

ONE-YEAR

Any part of the dishwasher which fails due to a defect in materials or workmanship. During this **full one-year warranty**, GE will also provide, **free of charge**, all labor and in-home service to replace the defective part.

Second Year

Any part of the dishwasher which fails due to a defect in materials or workmanship. During this **second-year limited warranty**, you will be responsible for any labor or in-home service costs.

Five Years

The **dishwasher rack**, if it should rust, or the **electronic control module** if it should fail due to a defect in materials or workmanship. During this **five-year limited warranty**, you will be responsible for any labor or in-home service costs.

Twenty Years

The **PermaTuf® tub or door liner**, if it fails to contain water due to a defect in materials or workmanship. During this **full twenty-year warranty**, GE will also provide, **free of charge**, all labor and in-home service to replace the defective part.

.....
This warranty is extended to the original purchaser and any succeeding owner for products purchased for ordinary home use in the 48 mainland states, Alaska, Hawaii and Washington, D.C.

All warranty service will be provided by our Factory Service Centers or by our authorized Customer Care® servicers during normal working hours.

Should your appliance need service, during warranty period or beyond, call 800.444.1845.

WHAT IS NOT COVERED

• Service trips to your home to teach you how to use the product.

Read your Use and Care material.

If you then have any questions about operating the product, please contact your dealer or our Customer Relations office at the address below, or call, toll free:

GE Answer Center®
800.626.2000
consumer information service

- Improper installation.
- Replacement of house fuses or resetting of circuit breakers.

• Failure of the product if it is abused, misused, or used for other than the intended purpose or used commercially.

• Damage to product caused by accident, fire, floods or acts of God.

• Incidental or consequential damage to personal property caused by possible defects with this appliance.

• Cleaning or servicing of the air gap device in the drain line.

WARRANTOR IS NOT RESPONSIBLE FOR CONSEQUENTIAL DAMAGES.

Some states do not allow the exclusion or limitation of incidental or consequential damages, so the above limitation or exclusion may not apply to you. This warranty gives you specific legal rights, and you may also have other rights which vary from state to state. To know what your legal rights are in your state, consult your local or state consumer affairs office or your state's Attorney General.

Warrantor: General Electric Company. If further help is needed concerning this warranty, write: Manager—Customer Relations, GE Appliances, Louisville, KY 40225.

Part No. 165D4700P156 Rev. 2
Pub No. 49-5824-2