

Shark®

OWNER'S GUIDE

S3501CO



IMPORTANT SAFETY INSTRUCTIONS

SAVE THESE INSTRUCTIONS

For Household Use Only

WHEN USING YOUR SHARK STEAM MOP, BASIC SAFETY PRECAUTIONS SHOULD ALWAYS BE FOLLOWED, INCLUDING THE FOLLOWING:

READ ALL INSTRUCTIONS BEFORE USING YOUR STEAM MOP.

DANGER OF SCALDING.

Please use caution when using the steam mop. The steam emitted from the steam mop is very hot.

POLARIZED PLUG:

This appliance has a polarized plug (one blade is wider than the other). As a safety feature, this plug will fit into a polarized outlet only one way. If the plug does not fit fully into the outlet, reverse the plug. If it still does not fit, contact a qualified electrician. **Do not attempt to defeat this safety feature.**

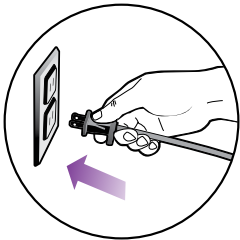

1. Use the system only for its intended use.
2. **DO NOT** use outdoors.
3. **DO NOT** leave the appliance unattended when plugged in. Always unplug the power cord from the electrical outlet when not in use and before servicing.
4. **DO NOT** allow the appliance to be used by children. Close attention is necessary when used by or near children, pets or plants.
5. Use only as described in this manual.
6. Use only manufacturer's recommended accessories.
7. **DO NOT** operate the appliance with a damaged plug or cord, or if the unit has been dropped or damaged. To avoid the risk of electric shock, do not disassemble or attempt to repair the appliance on your own. Return the appliance to EURO-PRO Operating LLC (see warranty) for examination and repair. Incorrect re-assembly or repair can cause a risk of electrical shock or injury to persons when the appliance is used.
8. To protect against a risk of electric shock, **DO NOT** immerse the steam mop into water or any other liquids.
9. **DO NOT** handle plug or steam mop with wet hands or operate appliance without shoes.
10. **DO NOT** pull or carry by power cord, use power cord as handle, close a door on the power cord, or pull the power cord around sharp edges or corners. Keep power cord away from heated surfaces.
11. **DO NOT** unplug by pulling on power cord. To unplug, grasp the plug not the power cord. Do not use extension cords or outlets with inadequate current carrying capacity.
12. **DO NOT** put any objects into openings. Do not use with any opening blocked.
13. **DO NOT** put hands or feet under the steam mop. Unit gets very hot.
14. Use **ONLY** on flat, horizontal surfaces. Do not use on walls, counters or windows.
15. **DO NOT** use on leather, wax polished furniture or floors, synthetic fabrics, velvet or other delicate, steam sensitive materials.
16. **DO NOT** add cleaning solutions, scented perfumes, oils or any other chemicals to the water used in this appliance as this may damage the unit or make it unsafe for use. If you live in a hard water area, we recommend using distilled water in your steam mop.
17. When in use, NEVER turn the appliance over or on its side. **NEVER DIRECT STEAM TOWARDS PEOPLE, ANIMALS OR PLANTS.**
18. **NEVER LEAVE THE STEAM MOP IN ONE SPOT ON ANY SURFACE FOR ANY PERIOD OF TIME WHEN MICRO-FIBER POCKET IS ATTACHED.**
19. Carefully remove the micro-fiber pocket immediately after you have unplugged and allowed the steam mop to cool.
20. When cleaning the steam mop, unplug the power cord from the electrical outlet and clean with a dry or damp cloth. Do not pour water or use alcohol, benzene or paint thinner on the unit.
21. Extreme caution should be exercised when using this appliance to clean stairs.
22. Never use steam mop without micro-fiber pocket attached.
23. Keep your work area well lit.
24. Store steam mop indoors in a cool, dry place.
25. To avoid circuit overload, do not operate another appliance on the same socket (circuit) as the steam cleaner.
26. If an extension cord is absolutely necessary, an extension cord rated a minimum of 15 ampere, 14 gage cord should be used. Cords rated for less amperage may overheat. Care should be taken to arrange cord so that it cannot be pulled or tripped over.
27. **DO NOT** leave your Steam Mop unattended when the system is connected to a power supply /electrical outlet.
28. **DO NOT** store unit with damp/wet micro-fiber cleaning pocket attached. Never leave the steam mop in one spot on any surface for any period of time with a damp or wet micro-fiber cleaning pocket attached as this will damage your floors.
29. Always unplug and allow the steam mop to cool before removing or changing mop heads.

 **WARNING:** Your steam mop is designed to clean hard floor surfaces that will withstand high heat. Do not use on unsealed wood or unglazed ceramic floors. On surfaces that have been treated with wax or some no wax floors, the sheen may be removed by the heat and steam action. It is always recommended to test an isolated area of the surface to be cleaned before proceeding. We also recommend that you check the use and care instructions from the floor manufacturer.

Quick Start

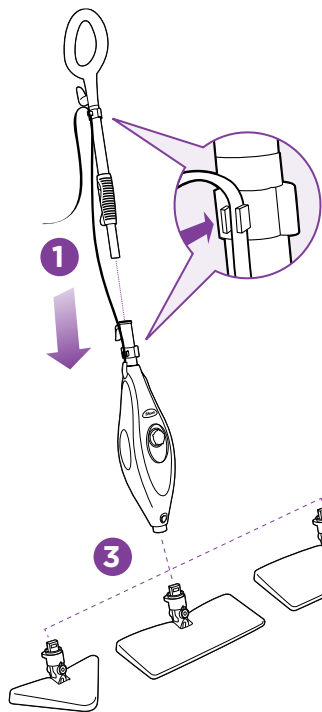

When assembling your steam mop there may be a little water in or around the water tank. This is because we test all our steam mops 100% before you buy them, so you get a quality Shark® Steam Mop.

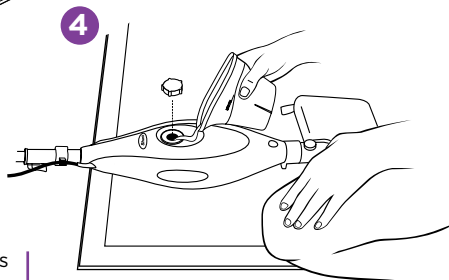
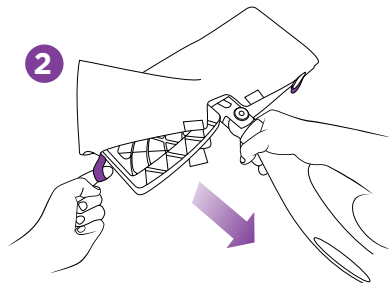

ASSEMBLE

- 1 Insert the mop handle into the pump actuator (the tube that leads to the tank). Push the mop handle and pump actuator together in until you hear it click into place.
- 2 Select a mop head and cleaning pad. Choose from the Rectangle, Triangle or XL Rectangle mop head. Fit one side of the pocket onto the head first, then using the lavender loop, pull the pocket over the head. Attach the quick fasteners on the top of the pocket to secure in place.
- 3 Snap the mop head into the base to secure it. Press the release button to exchange mop heads.

FILL

- 4 Lay the mop on the floor or on a counter top and remove the water tank cap by turning counter clockwise. Fill the water tank using the filling flask. Do not overfill the water tank. Replace the water cap and tighten.
- IMPORTANT:** Make sure your floors are sealed. Before using the Steam Mop consult page 4 for more information.

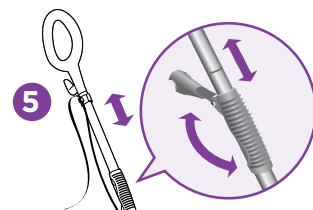

- QUICK TIP:** For easier pushing and pulling, extend the handle length.

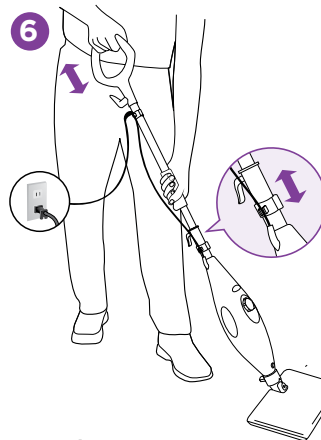

PREPARE

- 5 For your comfort, you can adjust the height of the mop. Just lift the latch on the tube 90 degrees to the open position. Holding the handle, extend the tube to the height that's right for you and then close latch to locked position.
 - 6 Plug in mop and wait 30 seconds or less for the mop to heat up. **Pump the handle of the mop by pushing downward about 10 to 12 times to create steam.**
- NOTE:** Steam is created automatically when you start mopping.

TIPS

DIRT CAN'T HIDE ON EITHER SIDE! All new design allows for optimal cleaning! When one side of the pocket gets dirty, just turn the mop head over and clean with the other side of the pocket.

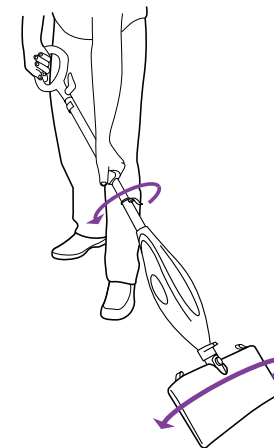

- QUICK TIPS:** We've added an additional mop head. You can now choose from a Rectangle mop head for all the rooms in your house or the Triangle mop head that is perfect for bathrooms and tight spaces or the XL Rectangle mop head for big jobs.
- NOTE:** Do not leave your Steam Mop unattended during use.
- IMPORTANT:** Never leave the steam mop in one spot for any period of time with a damp or wet micro-fiber pocket attached as this will damage your floors.



Contents

Thank you for
purchasing
the Shark®
Steam Mop.

- Getting Started2
- Using Your Steam Mop6
- Using Your Carpet Glider8
- Care of Your Steam Mop9
- Ordering Replacement Parts11
- Troubleshooting Guide12
- Warranty and Registration13



Getting Started

When assembling your steam mop there may be a little water in or around the water tank. This is because we test all our steam mops 100% before you buy them, so you get a quality Shark® Steam Mop.

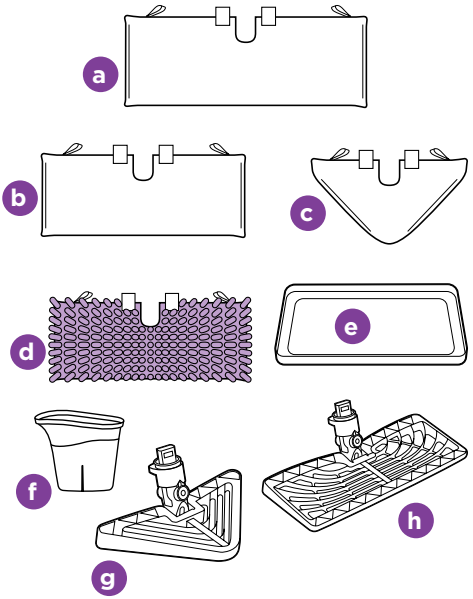

- a XL Rectangle Cleaning Pad
- b Rectangle Cleaning Pad
- c Triangle Cleaning Pad
- d Steam Duster Cleaning Pad
- e Carpet Glider
- f Filling Flask
- g Triangle Mop Head
- h Rectangle Mop Head

TECHNICAL SPECIFICATIONS

Voltage: 120V., 60Hz.
 Power: 1550 Watts
 Water Capacity: 450 ml (15 oz.)

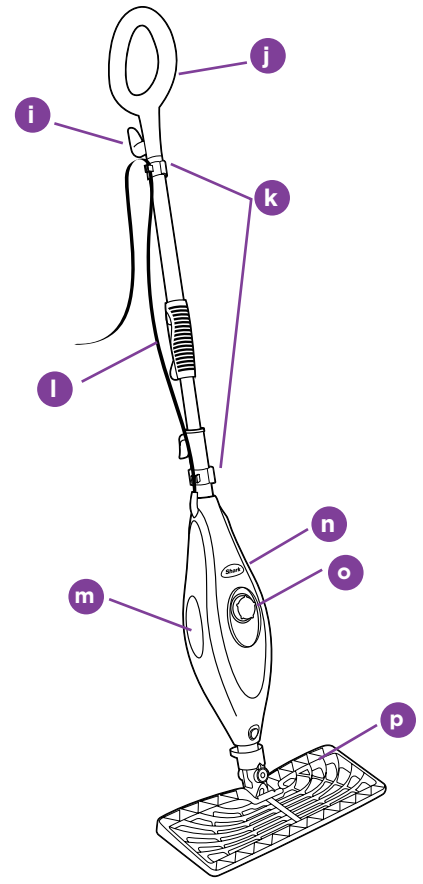

- i Quick Release Swivel Cord Wrap
- j Mop Handle
- k Cord Clips
- l Telescopic Handle Latch
- m Water Tank Viewing Window
- n Power-On Blue Light (Lights up when plugged-in)
- o Water Tank Cap
- p XL Rectangle Mop Head

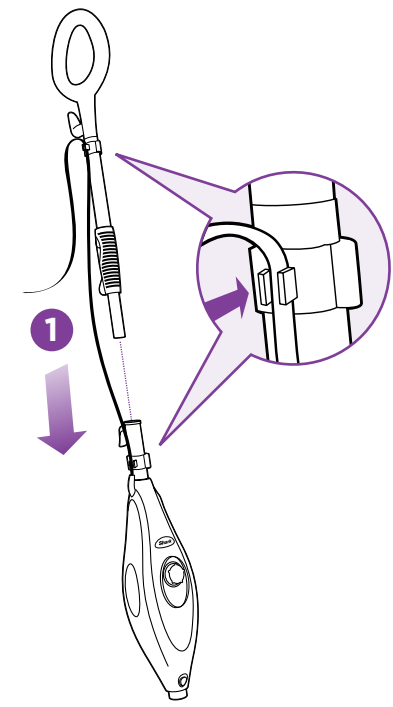

IMPORTANT: First things first, always make sure the mop is **UNPLUGGED** from the wall when not in use. Never fill the mop, attach the mop head, change or remove the micro-fiber pocket when the mop is plugged into the wall. **If you have hard water you might want to use distilled water to prolong the life of the Shark® Steam Mop.** Make sure you only add water to the tank. Chemicals or cleaning solution may damage the appliance and could be unsafe for you and your family.

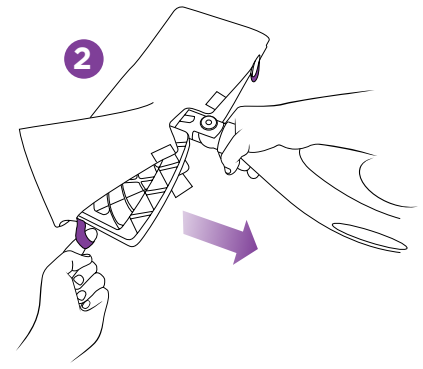

- ASSEMBLE**
- 1 Insert the mop handle into the pump actuator (the tube that leads to the tank). Push the mop handle and pump actuator together until you hear it click into place.
 - 2 Select a mop head and cleaning pad. Choose from the Rectangle, Triangle or XL Rectangle mop head. Fit one side of the pocket onto the head first, then using the lavender loop, pull the pocket over the head. Attach the quick fasteners on the top of the pocket to secure in place.

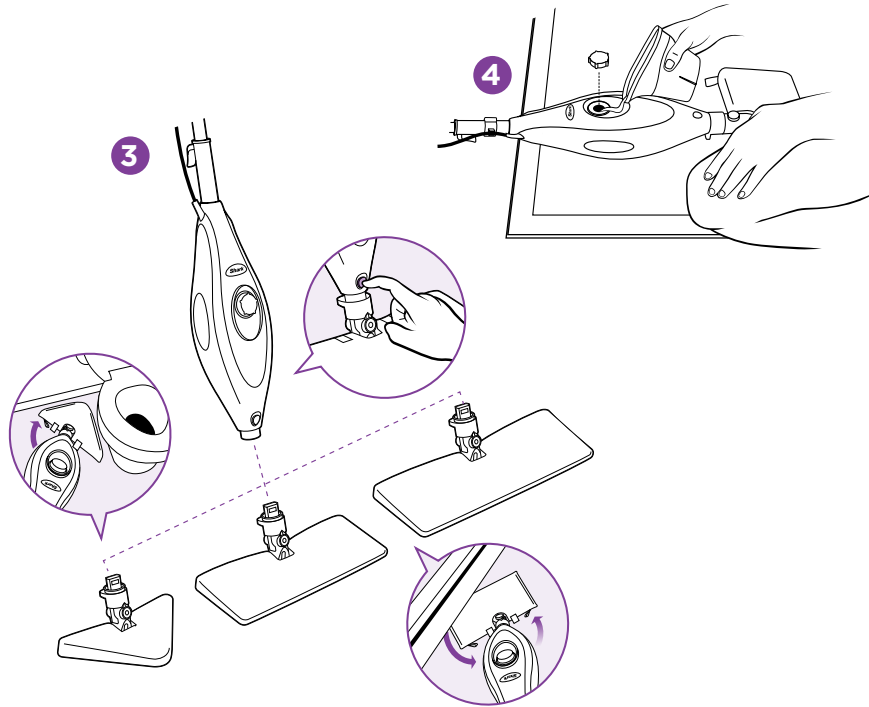

- 3** Snap the mop head into the base to secure it. Press the release button to exchange mop heads.
- 4** Turn the water tank cap counter clockwise and remove from the tank. Use the filling flask and pour water into the tank. Please don't overfill. Replace the cap on the water tank by turning clockwise and tightening.

⚠ IMPORTANT: Don't use on unsealed wood or unglazed ceramic floors. On surfaces that have been treated with wax or some no wax floors, the sheen may be removed by the heat and steam action. It is always recommended to test an isolated area of the surface to be cleaned before proceeding. We recommend that you check the use and care instructions from the floor manufacturer.

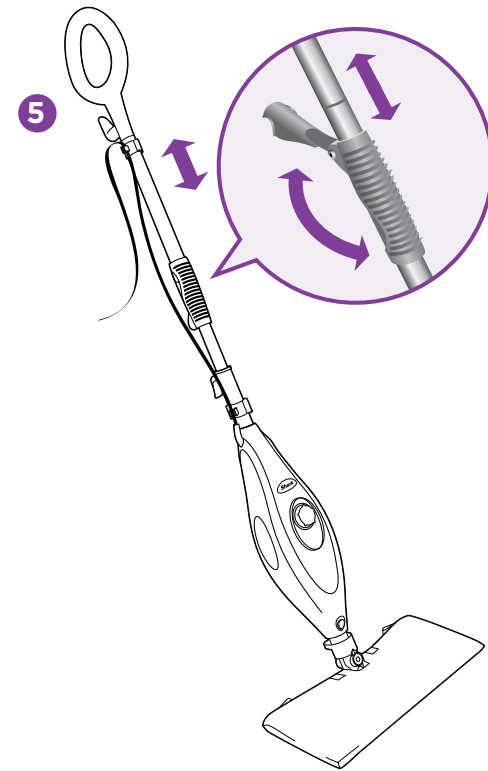

- 5** For your comfort, you can adjust the height of the mop. Just lift the latch on the tube 90 degrees to the open position. Holding the handle, extend the tube to the height that's right for you and then close latch to locked position.

⚠ QUICK TIP: For easier pushing and pulling, extend the handle length.

Using Your Steam Mop

IMPORTANT: Make sure you don't use the mop without attaching a micro-fiber pocket and adding water to the tank first. **When you are using the mop for the first time, it might take longer than the normal 30 seconds to start steaming. Just pump the handle a few times in a downward motion to prime the pump and it should be ready.**

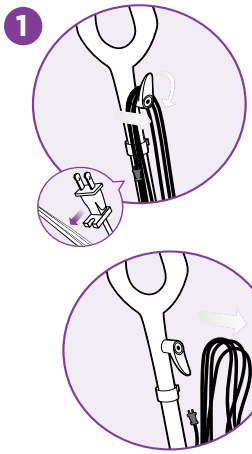

NOTE: Make sure the floors are swept or vacuumed before using the steam mop.

1 Pull and twist the quick release cord holder to unwrap the power cord completely. A great time saver!

Plug into a 120-volt electrical outlet. The power "On" light will turn blue, it takes approximately 30 seconds for the mop to heat up and the steam to be ready.

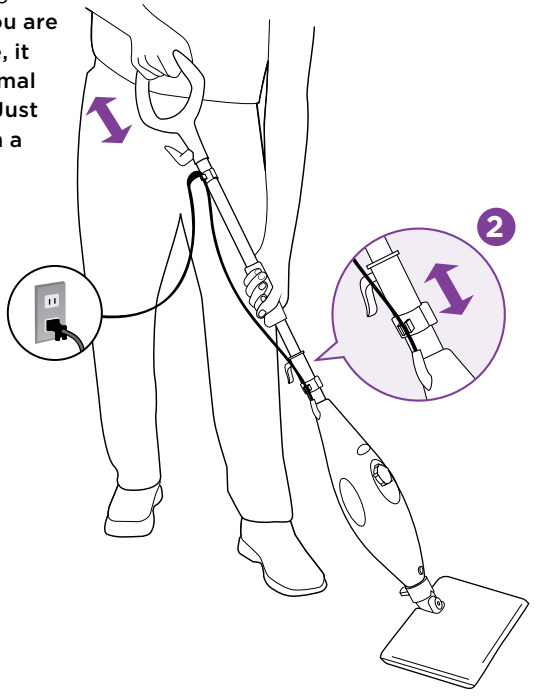

2 Pump the handle a few times in a downward motion. This pumping action will release steam as you mop and allows you to customize the amount of steam you want. Begin mopping with a forward and backward motion. The natural motion of mopping will produce steam.

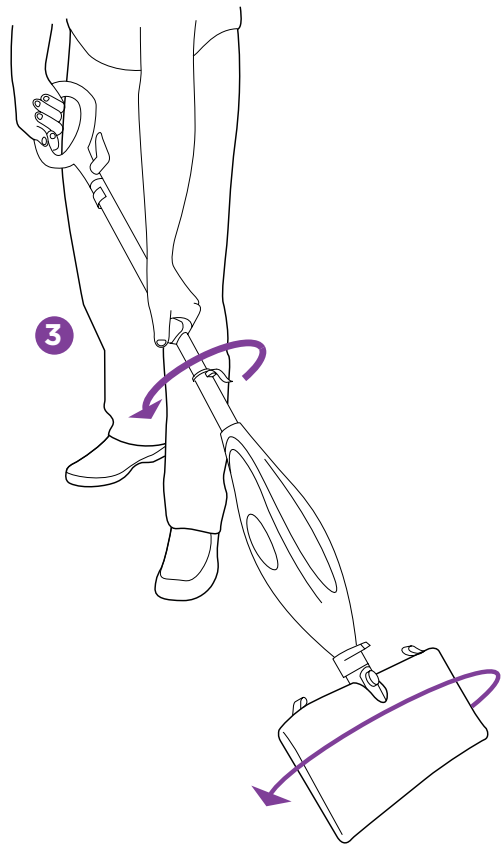

3 When one side of the micro-fiber pocket gets dirty, just flip the mop head and you can quickly start using the other side. Dirt can't hide on either side.

IMPORTANT: Please wait 3-5 minutes for the Steam Mop to cool off before switching the mop head or the micro-fiber pockets.

4 When the water tank is empty, the steam mop will stop producing steam. You can refill the water tank at any time as long as the mop is unplugged from the outlet. Follow the instructions from page 3. This goes for switching the mop heads or micro-fiber pockets as well.

IMPORTANT: Never leave the steam mop with a damp/wet micro-fiber pocket on any floor surface for any amount of time as this may damage the floor.

The Steam Mop won't clean your carpeting or area rugs. However, it's great for deodorizing and freshening.

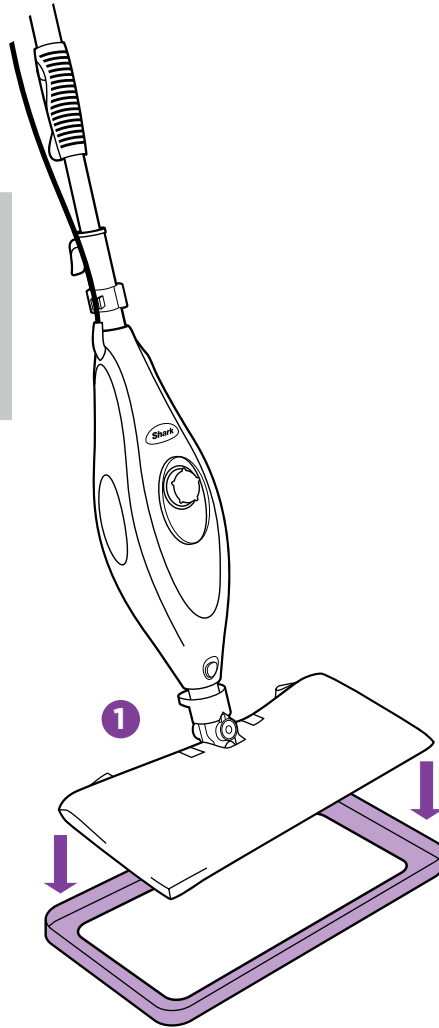

THE CARPET GLIDER

- 1 The Carpet Glider can be used with the Rectangle head to lightly steam your carpet and area rugs. Just place the mop head on top of the glider and move back and forth across a section of the carpet. The steam mop won't clean your carpeting or areas rugs, but it's great for deodorizing and freshening.

NOTE: Please note that the Steam Mop rests on top of the carpet glider and it is not a fixed attachment. Do not leave steam mop with carpet glider in one stationary position for any period of time.

AFTER USE AND STORAGE

- 1 When you have finished using the steam mop, and your floors are clean, unplug the cord from the outlet and move it into an upright position. Let the unit cool 2-3 minutes and release steam by pumping the handle several times before removing the micro-fiber cleaning pocket from the mop head.

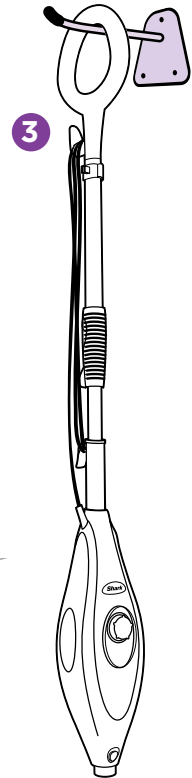
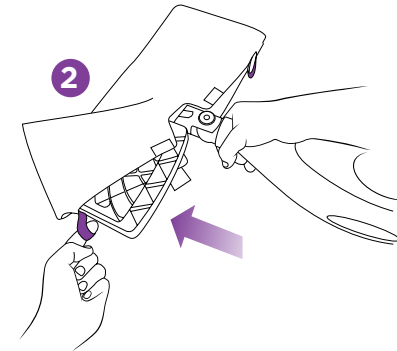
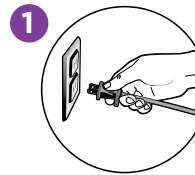

- 2 Remove the micro-fiber cleaning pocket by releasing the quick fasteners and using the lavender loop on the side of the pocket, avoiding contact with the hot pocket or dirt. Then empty the water tank.

IMPORTANT: Be very careful because the cleaning pockets can get very hot from the steam, so use caution when removing them. Let the unit cool 2-3 minutes.

- 3 To store the Shark® Steam Mop hanging up; first remove the head (after it has cooled and the steam has been released) then hang on a large hook.

NOTE: If you want to store it standing upright then make sure it's leaning against a wall for added support and safety. Always store your Steam Mop with the micro-fiber pocket removed, away from children or high traffic areas.

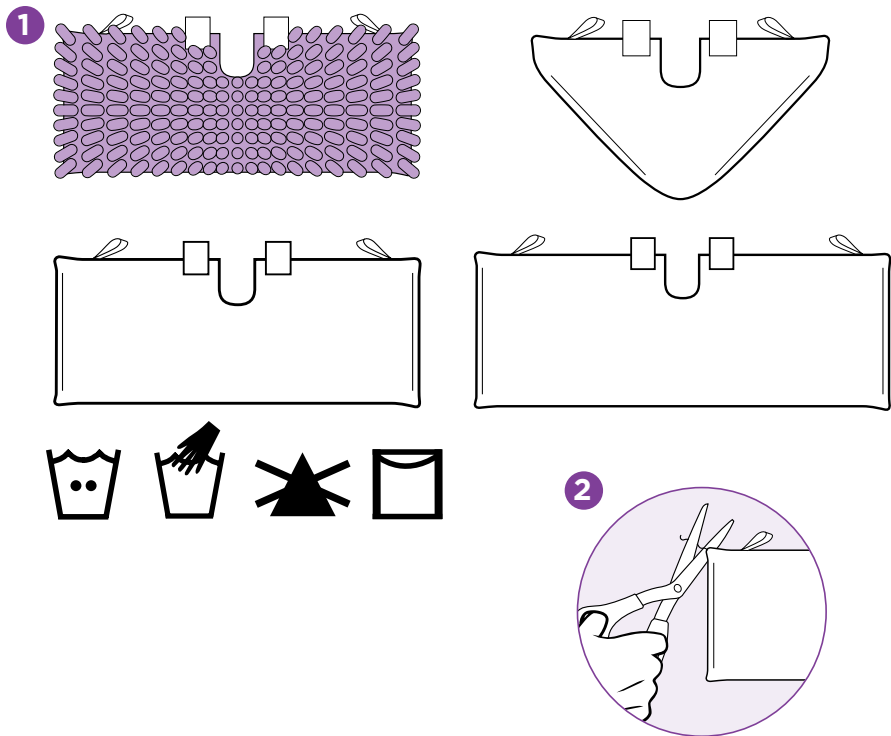

KEEPING YOUR MICRO-FIBER CLEANING POCKET AS GOOD AS NEW

1 We recommend washing your micro-fiber pockets separately from other fabrics to avoid picking up lint.

Only use liquid detergent. (no powder detergent) Don't use any fabric softeners or bleach.

Line dry or dry on a low dryer setting.

2 If there are loose threads on the pocket carefully cut the thread with scissors. Don't pull on them or cut at the base.

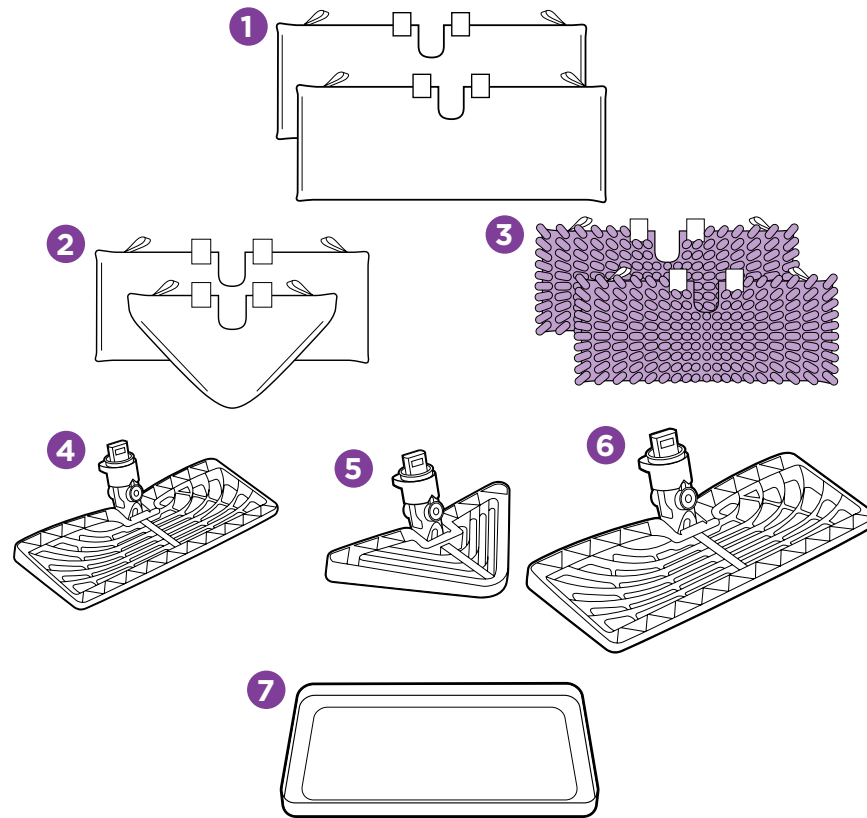

ORDERING REPLACEMENT PARTS

To order additional parts and accessories, feel free to contact us at www.sharkcompany.com or call **1-800-798-7398**.

PART	PART NO.
1 (2) XL Cleaning Pads	XLT3501
2 (2) All-Purpose Cleaning Pads	XT3501
3 (2) Steam Duster Cleaning Pads	XT3501SD
4 Rectangle Mop Head	1024SO
5 Triangle Mop Head	1025SO
6 XL Rectangle Mop Head	1023SO
7 Carpet Glider	XCG3501CS

PROBLEM	POSSIBLE REASONS & SOLUTIONS
The Steam Mop will not turn on.	Your Steam Mop should be securely plugged into a 120V AC electrical outlet only. Check your fuse or breaker. If your unit still doesn't work, give us a call 1-800-798-7398
Steam Mop will not make steam.	Prime the pump, see page 4 for more information. Is there water in the water tank? If not, add water to your Steam Mop following the instructions.
Steam Mop leaves water on the floor.	Check to see if your micro-fiber cleaning pocket is too wet. We recommend you unplug the Steam Mop and change the micro-fiber cleaning pocket. Make sure the steam pocket is attached correctly.
Steam Mop is hard to push.	Make sure the steam pocket is attached correctly. Check to see if your pocket is excessively dirty. Try increasing the height of the pole for better leverage.
Floors are cloudy, streaky or spotty after steaming.	The micro-fiber pocket might be dirty. Flip or change the pocket. If you washed the pocket with powder detergent then the pocket might be ruined. If you are cleaning in a kitchen area where there might be a build-up of grease then use a degreasing agent such as an all-purpose cleaner or dish soap and paper towels to clean the area first. You might have left the mop in the same spot for too long. Do you have hard water? If you do you, we recommend switching to distilled water.

ONE (1) YEAR LIMITED WARRANTY

EURO-PRO Operating LLC warrants this product to be free from defects in material and workmanship for a period of one (1) year from the date of the original purchase, when utilized for normal household use, subject to the following conditions, exclusions and exceptions.

If your appliance fails to operate properly while in use under normal household conditions within the warranty period, return the complete appliance and accessories, freight prepaid. For Customer Service support, call 1 (800) 798-7398 or visit our website www.sharkcompany.com.

If the appliance is found to be defective in material or workmanship, **EURO-PRO Operating LLC** will repair or replace it free of charge. Proof of purchase date and \$ 9.95 to cover the cost of return shipping and handling must be included. *

The liability of **EURO-PRO Operating LLC** is limited solely to the cost of the repair or replacement of the unit at our option. This warranty does not cover normal wear of parts and does not apply to any unit that has been tampered with or used for commercial purposes. This limited warranty does not cover damage caused by misuse, abuse, negligent handling or damage due to faulty packaging or mishandling in transit. This warranty does not cover damage or defects caused by or resulting from damages from shipping or repairs, service or alterations to the product or any of its parts, which have been performed by a repair person not authorized by **EURO-PRO Operating LLC**.

This warranty is extended to the original purchaser of the unit and excludes all other legal and/or conventional warranties. The responsibility of **EURO-PRO Operating LLC** if any, is limited to the specific obligations expressly assumed by it under the terms of the limited warranty. **In no event is EURO-PRO Operating LLC** liable for incidental or consequential damages of any nature whatsoever. Some states/provinces do not permit the exclusion or limitation of incidental or consequential damages, so the above may not apply to you.

This warranty gives you specific legal rights, and you may also have other rights which vary from state to state or province to province.

***Important: Carefully pack item to avoid damage in shipping. Be sure to include proof of purchase date and to attach tag to item before packing with your name, complete address and phone number with a note giving purchase information, model number and what you believe is the problem with item. We recommend you insure the package (as damage in shipping is not covered by your warranty). Mark the outside of your package "ATTENTION CUSTOMER SERVICE". We are constantly striving to improve our products, therefore the specifications contained herein are subject to change without notice.**



OWNERSHIP REGISTRATION CARD FOR CANADIAN CONSUMERS ONLY

Please complete and return within ten (10) days of purchase. The registration will enable us to contact you in the event a product defect is discovered. By returning this card you acknowledge to have read and understood the instructions for use, and warnings set forth in the accompanying instructions.

RETURN TO: **EURO-PRO Operating LLC**, 4400 Bois Franc, St. Laurent, Quebec H4S 1A7

PURCHASER:

ADDRESS:

DATE OF PURCHASE: MODEL: **S3501 CO**

NAME AND ADDRESS OF STORE:



U.S.: EURO-PRO Operating LLC
Boston, MA 02465

Canada: EURO-PRO Operating LLC
4400 Bois Franc
Ville St. Laurent, Québec H4S 1A7

1-800-798-7398

www.sharkcompany.com

COPYRIGHT© EURO-PRO OPERATING LLC 2009

PRINTED IN CHINA

REV. 090501

Illustrations may differ with actual product.