



DishDrawer®

Use and Care Guide



MODELS:

DD124P5

DD224P5



Safety and warnings	3
Controls	6
Operation	8
Wash program chart	9
Caring for your dinnerware	10
Dishwasher standards test	11
Accessories	12
Loading	14
Detergent dispenser	16
Rinse agent dispenser	18
Option adjustments	19
User maintenance instructions	21
Troubleshooting	24
Fault codes	26
Warranty and service	29

Important!

SAVE THESE INSTRUCTIONS

The models shown in this User Guide may not be available in all markets and are subject to change at any time. For current details about model and specification availability in your country, please go to our website www.dcsappliances.com or contact your local DCS by Fisher & Paykel dealer.

Your DishDrawer has been carefully designed to operate safely during normal dishwashing procedures. Please keep the following guidelines in mind when you are using your DishDrawer®. Please read all instructions before operating the DishDrawer®.

Important safety precautions

- *The information in this manual must be followed to minimize the risk of fire or explosion or to prevent property damage, personal injury or loss of life.*
- *Use the DishDrawer® only for its intended function as described in this User Guide.*
- *Use only detergents or rinse agent recommended for use in a domestic Dishwasher and keep them out of reach of children. Check that the detergent dispenser is empty after the completion of each wash program.*
- *When loading items to be washed, locate sharp items so that they are not likely to damage the lid seal and load sharp knives with the handles up to reduce the risk of cut type injuries.*
- *Do not touch the heater plate during or immediately after use.*
- *Do not operate your DishDrawer® unless all the enclosure panels are properly in place.*
- *Do not tamper with the controls.*
- *Do not abuse, sit on, stand in or on the drawer or dish rack of the DishDrawer®.*
- *The cup racks are designed to support cups, glasses and kitchen utensils. When the cup racks are in the DishDrawer® do not lean on or use the cup racks to support your body weight.*
- *To reduce the risk of injury, do not allow children to play in or on the DishDrawer®.*
- *Under certain conditions hydrogen gas may be produced in a hot water heater system that has not been used for two weeks or more. HYDROGEN GAS IS EXPLOSIVE. If the hot water system has not been used for such a period, before using the dishwasher, turn on all hot water taps and let the water flow from each for several minutes. This will release any accumulated hydrogen gas. As gas is flammable, do not smoke or use an open flame during this time.*
- *Remove the door to the washing compartment when removing an old dishwasher from service or discarding it.*
- *Dishwasher detergents are alkaline. They can be dangerous if swallowed. Avoid contact with skin and eyes, keep children and infirm person(s) away from the dishwasher when the drawer is opened.*

Important safety precautions

Installation

- *This DishDrawer® must be installed and located in accordance with the Installation Instructions before it is used. If you did not receive Installation Instruction sheets with your DishDrawer®, you can order them by calling your Authorized Service Agent or from the DCS by Fisher & Paykel website, www.dcsappliances.com.*
- *Installation and service must be performed by a qualified technician.*
- *If the power supply cord is damaged, it must be replaced by a dealer or Authorized Service Center or a similar qualified trades person in order to avoid a hazard.*
- *Ensure the DishDrawer® is secured to adjacent cabinetry using the brackets provided. Failure to do so may result in an unstable product, which may cause damage or injury.*
- *Do not operate this appliance if it is damaged, malfunctioning, partially disassembled or has missing or broken parts, including a damaged power supply cord or plug.*
- *Do not store or use gas, or other flammable vapors and liquids in the vicinity of the DishDrawer®.*
- *Connect to a properly rated, protected and sized power supply circuit to avoid electrical overload.*
- *Make sure that the power supply cord is located so that it will not be stepped on, tripped over or otherwise subject to damage or stress.*
- *Do not install or store the DishDrawer® where it will be exposed to temperatures below freezing or exposed to weather.*
- *Do not use an extension cord or a portable electrical outlet device (e.g. multi-socket outlet box) to connect the DishDrawer® to the power supply.*
- *This appliance must be grounded. In the event of a malfunction or breakdown, grounding will reduce the risk of electric shock by providing a path of least resistance for electric current. This appliance is equipped with a cord having an equipment-grounding conductor and a grounding plug. The plug must be plugged into an appropriate outlet that is installed and grounded in accordance with all local codes and ordinances. Improper connection of the equipment-grounding conductor can result in a risk of electric shock. Check with a qualified electrician or service representative if you are in doubt as to whether the appliance is properly grounded.*

Maintenance

- *Do not repair or replace any part of the appliance or attempt any servicing unless specifically recommended in this User Guide. We recommend that you call an Authorized Service Agent.*
- *Keep the floor around your appliance clean and dry to reduce the possibility of slipping.*
- *Keep the area around/underneath your appliance free from the accumulation of combustible materials, such as lint, paper, rags and chemicals.*
- *When cleaning the underside of the filter plate, care must be taken on the sharp outer edge to avoid the risk of cut type injuries.*

Important safety precautions

Important!



Under no circumstances should you open the drawer while the DishDrawer® is in operation.

Operational

- *Always press the ►/|| button to pause and wait until you hear the three additional beeps before opening the drawer.*
- *The DishDrawer® must be used with the motor assembly, filter plate, drain filter and spray arm in place.*
- *When disconnecting the appliance grasp the plug rather than the power supply cord or junction of cord to avoid damage.*
- *Take care when loading the DishDrawer® not to load dishware items so they prevent the lid from properly sealing with the drawer. Items should be placed so they do not protrude above and/or forced into the drawer, otherwise a service call may result.*
- *Household appliances are not intended to be played with by children. Children or persons with a disability which limits their ability to use the appliance, should have a responsible person instruct them in its use. The instructor should be satisfied that they can then use the appliance without danger to themselves or their surroundings.*
- *Close supervision is necessary if this appliance is used by or near children. Do not allow children to play inside, on or with this appliance or any discarded appliance.*
- *If a Dishwasher cleaner is used, we would strongly recommend a wash program with detergent should be run immediately afterward, to prevent any damage to the DishDrawer®.*
- *The DishDrawer® is designed for washing normal household utensils. Items that are contaminated by petrol, paint, steel or iron debris, corrosive, acidic or alkaline chemicals are not to be washed in the DishDrawer®.*
- *If the DishDrawer® is not being used for long periods of time, turn the electricity and water supply to the DishDrawer® off.*



If you have a double DishDrawer®, each drawer has its own controls and can run independently of the other.

Power button

The  button turns the DishDrawer® on or off. Opening the drawer will automatically turn the DishDrawer® on for 30 seconds. To end a wash program in mid cycle, press the  button. Any water in the DishDrawer® will be pumped out.







Start/Pause button

The  button starts a wash program. Press the  button to pause or restart the DishDrawer® during a wash program. When paused, wait for three beeps before opening the drawer. Forcing the drawer open while in mid cycle may cause damage or injury.

Delay Start

The  button also sets the Delay Start feature which can delay the start of a wash program from 1 to 12 hours.

To activate Delay Start

- 1 Press and hold the  button until the light above the  button turns purple.
- 2 Continue holding the  button down until the desired delay time has been reached. The DishDrawer® will emit audible 'beeps' as you hold the  button down, each beep indicates another hour delay.
- 3 The DishDrawer® will start once the drawer is closed and the delay time has elapsed.

To cancel Delay Start



Press the  button.

Lock button (optional)

The  button activates/deactivates the Keylock or the Childlock functions.



Keylock



The Keylock feature disables all the buttons on the DishDrawer®.

To activate, press and hold the  button until you hear one beep (3 seconds). The light above the  button is lit when Keylock is activated.

To cancel the Keylock feature, press and hold the  button until the light above the  button disappears.

Childlock

The Childlock feature locks the drawer and disables all the buttons on the badge. To activate, press and hold the  button until you hear two beeps (5 seconds). The light above the  button is lit when Childlock is activated.

To cancel the Childlock feature, press and hold the  button until the light above the  button disappears.

Wash program selector

Press the  button inside the drawer to select a wash program. The DishDrawer® will remember the last program used.



Eco button (optional)

Press the  button if you would like the wash program to use less energy and water. The red ECO light will indicate the feature is on. If your dishes are heavily soiled or you require enhanced dry performance, we do not recommend ECO programs.

Power failure

If the DishDrawer® is operating and a power failure occurs, it will stop. The DishDrawer® may be unable to be opened during this time. When the power supply is resumed, the DishDrawer® will restart in the same part of the wash program.

Operation

- 1 Load dishes**
Remove all food scraps and load the dishes.
- 2 Add detergent**
- 3 Check rinse agent**
- 4 Press the  button**
- 5 Select a wash program**
- 6 Select *eco* (optional)**
- 7 Check**
Ensure there is nothing obstructing the spray arm. The drain filter must be level with the filter plate.

- 8 Start**
Close the drawer and press the  button.
- 9 Finish**
The DishDrawer® will beep six times to indicate the end of the wash program. At the end of the wash program the drying fan will continue to run for a set time or until the drawer is opened. The fan assists with drying and uses negligible amounts of energy. It is normal for some water to remain in the drain filter area after the wash program is complete.
DD224 only: At the end of a wash program, you may find both drawers draining simultaneously. This is normal.

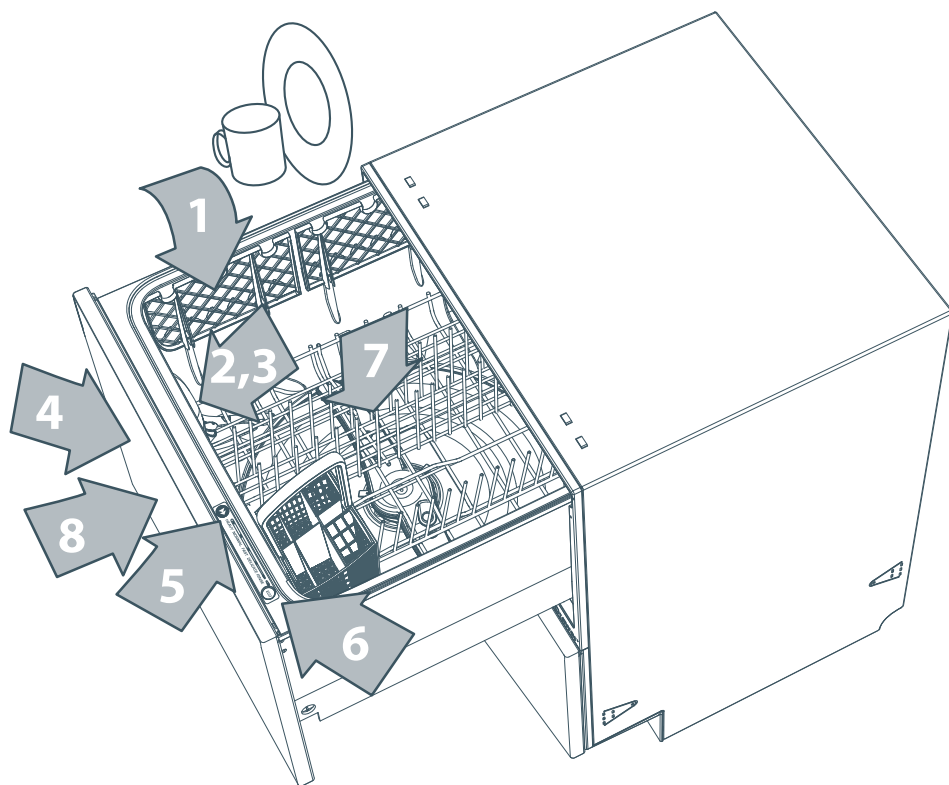

Standard wash program - when to use

Heavy <i>Heavily soiled pots, pans and dishes.</i>	Normal <i>Dishes with normal soils for optimum wash and dry performance.</i>	Fast <i>Lightly soiled dishes.</i>	Delicate <i>Lightly soiled and heat sensitive crockery.</i>	Rinse <i>Prevents odors and soils drying on dishes.</i>
pre wash 1	pre wash 1		pre wash	pre wash
pre wash 2	pre wash 2			
main wash 150°F	main wash 140°F	main wash 130°F	main wash 120°F	
post rinse 1	post rinse	post rinse	post rinse	
post rinse 2				
final rinse 163°F	final rinse 140°F	final rinse 120°F	final rinse 130°F	
drying phase	drying phase		drying phase	

Eco wash program - when to use

Heavy <i>Heavily soiled everyday dishes.</i>	Normal <i>Normal soiled dishes for optimum energy use.</i>	Fast <i>Lightly soiled, non greasy dishes.</i>	Delicate <i>Lightly soiled, non greasy and heat sensitive crockery.</i>
pre wash 1	pre wash		pre wash
pre wash 2			
main wash 150°F	main wash 130°F	main wash 115°F	main wash 115°F
post rinse 1	post rinse	post rinse	post rinse
post rinse 2			
final rinse 150°F	final rinse 130°F	final rinse 115°F	final rinse 120°F
drying phase	drying phase		drying phase

Note:

Wash times can vary depending on the incoming water temperature, ambient conditions, type of dish load and whether the drawer has been opened during the wash. Wash times are only APPROXIMATE and are based on 120°F incoming water.

Caring for your dinnerware

The combination of high temperatures and dishwasher detergent may cause damage to some items if they are washed in a dishwasher. Remember, if in any doubt about any aspect concerning items washed in the DishDrawer®, follow the instructions from the manufacturer of the items, or wash the item by hand.

Cutlery & silverware

All cutlery and silverware should be rinsed immediately after use to prevent tarnishing caused by some foods. The Rinse wash program is useful for this. Silver items should not come into contact with stainless steel, e.g. other cutlery. Mixing these items can cause staining. Remove silver cutlery from the DishDrawer® and hand dry it immediately after the program has finished if needed.

Aluminum

Aluminum can be dulled by dishwasher detergent. The degree of change depends on the quality of the product.

Other metals

Iron and cast iron objects can rust and stain other items. Copper, pewter and brass tend to stain.

Woodware

Wooden items are generally sensitive to heat and water. Regular use in a dishwasher may cause deterioration over time. If in doubt, wash by hand.

Glassware

Most everyday glassware is dishwasher safe. Crystal, very fine and antique glassware may etch that is, become opaque. You may prefer to wash these items by hand.

Plastic

Some plastic may change shape or color with hot water. Check manufacturer's instructions about washing plastic items. Washable plastic items should be weighed down so they do not flip over and fill with water or fall through the basket during the wash.

Decorated items

Most modern china patterns are dishwasher safe. Antique items, those with a pattern painted over the glaze, gold rims or hand painted china may be more sensitive to machine washing. If in doubt, wash by hand.

Glued items

Certain adhesives are softened or dissolved in machine washing. If in doubt, wash by hand.

Vacation time

If the DishDrawer® is not going to be used for some time, we recommend you ensure the baskets are empty. Leave the inside of the DishDrawer® clean. Leave the drawers ajar to allow air to circulate. Turn off both the power and water supply to the DishDrawer®.

The DishDrawer®s are tested to various standards for both wash and dry performance. The following are loading pattern diagrams, detergent quantities and rinse agent quantities used for the DishDrawer®.

Wash Program

Normal Cycle

Detergent Quantities

- a. 5g (pre wash) per drawer
- b. 10g (main wash) per drawer

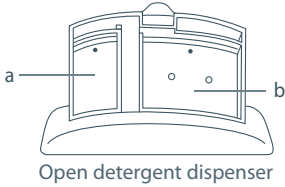

Rinse Agent

Setting 4

Recommended Loading Pattern



Top drawer



Bottom drawer

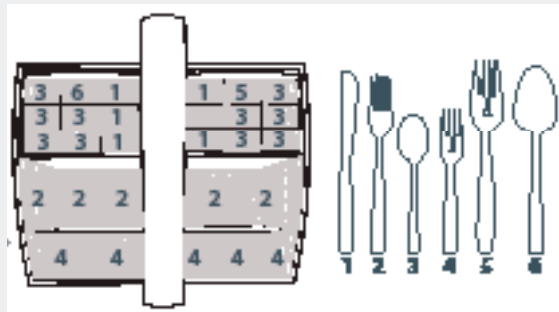

The inserts and racks can be added or removed to suit your individual needs. If you have the double DishDrawer® model, some of the accessories are interchangeable between the two drawers. For example you can combine the two Mega Racks into one drawer and wash all cups and glasses, leaving the other drawer for plates and larger items.

a. basket

The basket holds some of the accessories in place and keeps dishes away from the spray arm.

b. Drain filter access panel

The drain filter access panel is designed to snap onto the basket over the drain filter. This prevents objects from touching the base of the DishDrawer® and stopping the rotation of the spray arm, while still giving access to the drain filter.

c. Mega rack

The Mega rack is designed to hold glasses, cups and small plates.

d. Plate insert

The plate insert supports plates and bowls.

How to install the Mega rack

To install the Mega rack, place the outer legs of the rack on top of the basket, and clip the Mega rack to the side of the basket. When the Mega rack is correctly installed it should not feel loose in the basket.

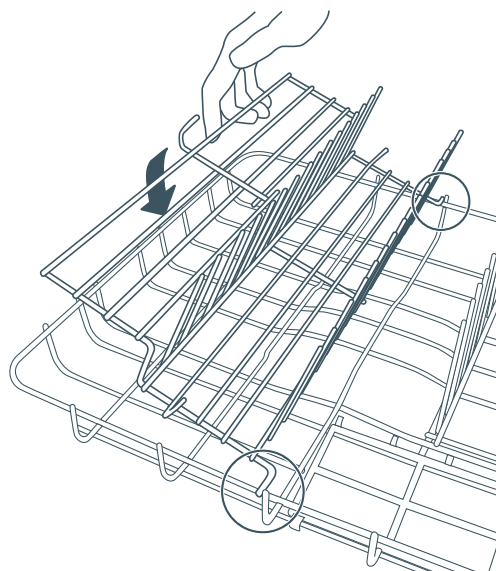
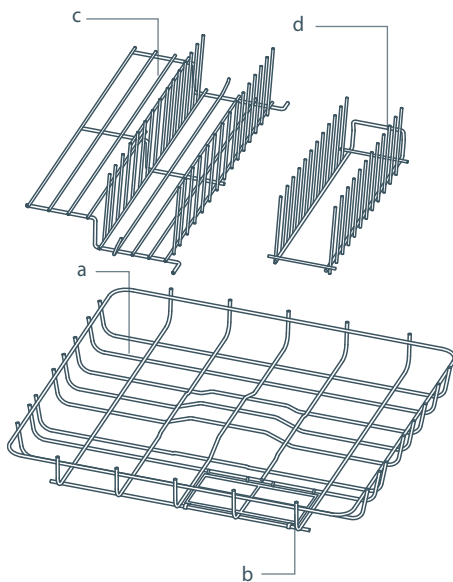

Cup racks

Cups, glasses and kitchen utensils can be placed on the left and right hand side of the cup racks.

- For best performance ensure there are no large items below, blocking the wash water from reaching the cup racks.
- Wine glasses can be supported on the cup racks if used in conjunction with the Mega rack.
- There are stops on the cup rack to prevent cups from touching the DishDrawer® wall. This will maximize the dry and wash performance.

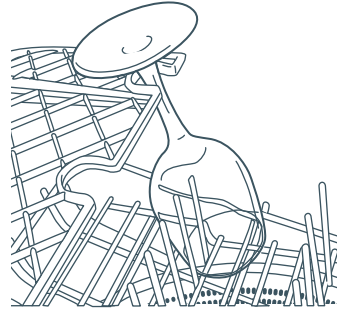

Cutlery basket

Cutlery, small kitchen utensils and some plastic lids are best placed into the cutlery basket.

- For best wash performance, we recommend loading cutlery with handles pointing down and sharp utensils with their handles facing up, to reduce the risk of injury.
- Mix spoons, knives and forks within each section, to stop cutlery from nesting together and to ensure the water circulates freely.
- Keep stainless steel from touching silver cutlery to avoid staining.
- Small items, like plastic lids, can be placed under the anti-nesting grid. This will prevent them from being displaced by wash water and falling to the bottom, where they may stop the spray arm rotation.

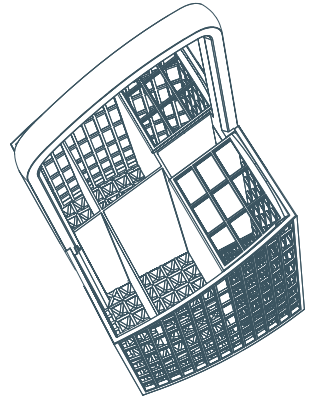

Loading

Wash water for the DishDrawer® comes from the spray arm which is situated inside the base of the drawer. The spray arm rotates, providing wash water to all areas of the wash compartment so care needs to be taken when loading dishes to ensure there is enough space for the water to reach all areas, particularly the cup racks. If there are any items blocking the spray arm path or the wash water, then the performance will be reduced.

How to load your DishDrawer®

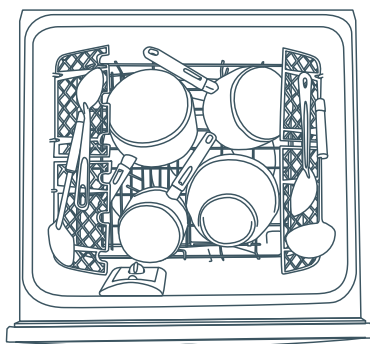
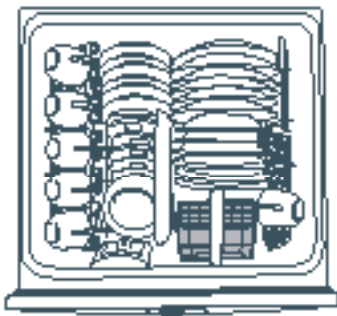

Note: The basket and its inserts are not designed to be lifted out of the DishDrawer® while loaded with dishes.

How NOT to load your DishDrawer®

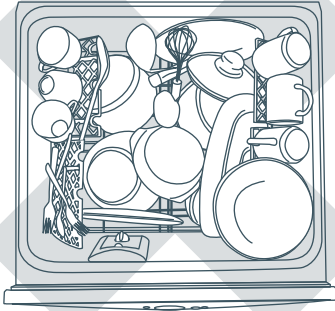

- Overcrowded and wash water will not reach some of the dinnerware.
- Cups, glasses and bowls must have their openings facing down.

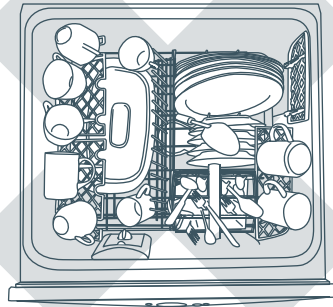

- The plates are nesting together and wash water may not get through.
- Ensure cutlery are not nesting or stuck together. They need to be evenly spread out.

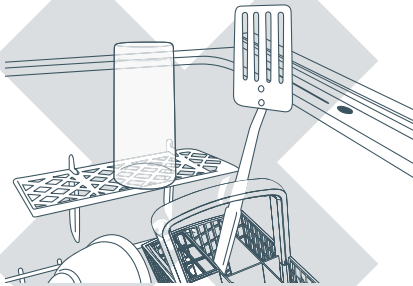

- Ensure dishware items are not forced into or protrude out of the drawer as it may prevent the lid from properly sealing which could result in a service call.
- Locate sharp items safely to prevent injuring the user and damaging the lid assembly.
- Check the bottom of the cutlery basket to ensure sharp or pointed items have not come through as they may stop spray arm rotation.

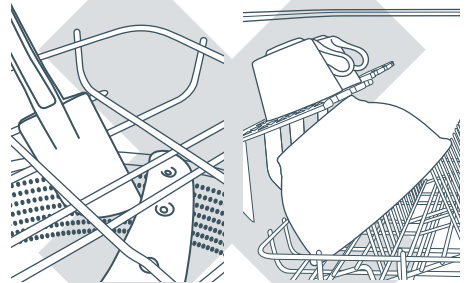

- Ensure cutlery has not fallen through the basket and stopped the spray arm from rotating.
- The large bowl is blocking wash water reaching the cup racks.
- Large utensils should be on cup racks so they do not become dislodged and stop the spray arm from rotating.
- Sharp or pointed items must be placed horizontally or with sharp edges/points facing down to avoid risk of injury.

Important!

- Only use powdered detergent recommended for domestic automatic dishwashers in the detergent dispenser.
- Dishwasher detergents are strongly alkaline and can be dangerous if swallowed.
- Avoid contact with skin and eyes.
- Keep children and infirm persons away from the DishDrawer® when the drawer is open.
- Check that the detergent receptacle is empty after completion of the wash cycle.
- Do not place dishwasher tablets in the detergent dispenser
- Detergent and dishwasher tablets should not be in direct contact with dishes or cutlery.
- Liquid detergents are not suitable to be used in the DishDrawer®.
- Hand washing liquids, soap, laundry detergents or disinfectants will damage the DishDrawer®.

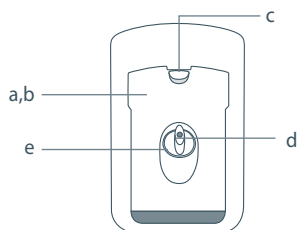

Closed detergent dispenser

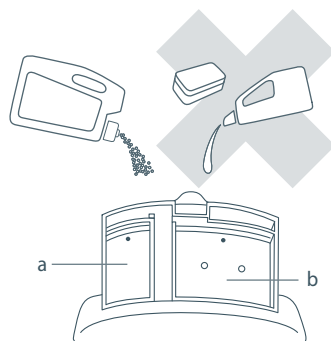

Open detergent dispenser

Filling the detergent dispenser

- 1 Press the latch down and the door will open.
- 2 Pour in detergent. No detergent is needed for the Rinse program.
- 3 After filling the main wash compartment, close the dispenser door until it clicks shut. The detergent will automatically be released into the DishDrawer® during the wash program.

- a Pre Wash Compartment
10g / 2 teaspoon capacity
- b Main Wash Compartment
30g / 6 teaspoon capacity
- c Detergent Dispenser Latch
- d Rinse Agent Indicator Light
- e Rinse Agent Plug

Detergent quantities

The detergent quantities recommended below are for individual drawers.

Wash type	Wash program	Detergent quantities	
		prewash (teaspoons)	main wash (teaspoons)
Hard (>150ppm or >9gpg)	All*	2	6
Medium (100-150ppm or 6-9gpg)	All*	2	4
Soft (<100ppm or <6gpg)	Heavy	1	3
	Normal	1	2
	Delicate		1
	Fast		1

* No detergent is required in the pre wash compartment for the fast wash program.

Hard water situations

If you live in a hard water situation, we recommend the installation of a household water softener to improve the water quality, detergent effectiveness and prevent the build-up of calcium deposits on dishes and in the DishDrawer®.

Certain brands of dishwasher detergent contain varying quantities of phosphates, which help soften water. We suggest you use a detergent with high phosphate content to improve the wash. The detergent compartments need to be completely FULL and rinse agent is used with its setting fixed at 5.

We recommend the use of a dishwasher cleaner/descaler whenever you notice a build-up of calcium deposits in your DishDrawer®.

After you have used the dishwasher cleaner/descaler you must run another wash program with detergent to prevent damage to the DishDrawer®.

Soft water situations

If you live in an area of naturally soft water or your household water is softened, avoid using too much detergent in your DishDrawer®. An excess amount of detergent is very aggressive on glassware and may cause irreversible etching.

Etching is a chemical deterioration that occurs on the surface of glassware when it is subjected to high temperatures, too much detergent and/or soft water situations. Etching is caused by a combination of very hot water, which causes the detergent to become very aggressive, but because the water is soft, there are no water hardness mineral ions for the detergent to bind to, so it extracts mineral ions directly from the glass.

Etching looks like rainbow-colored film, as the glass is subjected to further washing the surface will eventually appear opaque. This type of etching is irreversible.

To prevent further etching from occurring on glassware, use less detergent (follow the recommended detergent quantities in the User Guide for soft water situations), and ensure the dishwasher is not overloaded, so water can reach all the dishes during the wash.

Rinse agent dispenser

We highly recommend the regular use of liquid rinse agent to give the best drying results. Rinse agent gives a streak free, sparkling clean look to glass and chinaware, in addition it prevents metal from tarnishing. The rinse agent dispenser is on the inside of each drawer, located underneath the detergent dispenser. The dispenser holds approximately 1.7 fl oz (50 ml) of rinse agent.

Filling the rinse agent dispenser

- 1 Turn the plug counter-clockwise and remove.
- 2 Pour the rinse agent into the circular opening.
- 3 Take care not to spill rinse agent into the DishDrawer®. Any spillages must be wiped up to prevent excess foaming. Failure to wipe rinse agent spillages may result in a service call which will not be covered by warranty.
- 4 Fit the plug back into the original position.

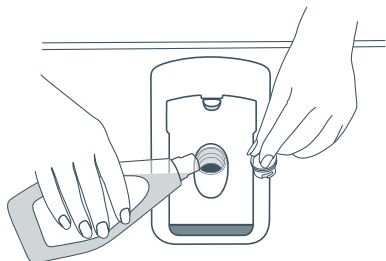

How much rinse agent to use

The regulator may need adjusting to suit your water conditions. The lowest setting is '1' and the highest is '5'. Refer to Option Adjustments section to adjust the rinse agent setting. If there is excessive foam at the end of the wash, reduce the setting. If dishes are wet or streaky after drying, increase the setting.

Rinse agent indicator light

If the rinse agent indicator light is red, refill the dispenser. If the rinse agent indicator light is dimly lit or not lit at all, there is enough rinse agent for the wash.

Note:

- Lighter colored rinse agents will not dim the indicator light as effectively as darker colored rinse agents.
- When the rinse agent is being dispensed, you may notice some unusual noises during the wash, this is normal.

The following options can be adjusted to suit your preferences.

Rinse Agent setting

Reduce the Rinse agent setting if there is excess foam after a wash program.

Increase the Rinse agent setting if dishes are wet or streaky after a wash program.



Auto Power setting

By default, DishDrawer® will automatically turn on whenever the drawer is opened. Washing will not start until the drawer is closed and the  button has been pressed. If you do not want the DishDrawer® to turn on automatically, this feature can be turned off.

End of Wash Program Beeps

By default, DishDrawer® will beep six times at the end of a wash program. This feature can be turned off.























Closed Drawer option

The Closed Drawer option will lock the DishDrawer® when the drawer is closed. When you wish to open the drawer, press the  button. When the drawer is fully closed again, the lid will automatically seal and lock after 30 seconds. If the Lock feature is used in conjunction with the Closed Drawer Option, pressing the  button will not unlock the drawer. The Lock feature must be turned off to enable DishDrawer® to be opened.

Note: this option is highly recommended if the DishDrawer is to be used in motor homes.

Option adjustments

How to make option adjustments

Follow the steps below	Rinse Agent setting	Auto Power option	End of Wash Program Beeps option	Closed Drawer option ¹
<p>First</p> <p>Enter Option Adjustment Mode</p> <ol style="list-style-type: none"> 1 Press the  button to turn power on. Open DishDrawer. 2 Press and hold the  and  buttons for 5 seconds until one long beep sounds. 	<p>red / off</p>  	<p>purple / on</p>  	<p>blue / on</p>  	<p>red / on</p>  
<p>Make an adjustment</p> <p>The current setting is shown on the wash program selector in red lights. If four red lights are lit, the option selected setting is set to four. Press the  button to increase the setting.</p>	<p>Press the  button to turn the selected option on or off.</p>			
<p>Save</p> <p>Press the  button to save the change.</p>				
<p>Example</p> <p>Rinse Agent setting set to four</p>	 <p>On</p>  <p>Off</p>	 <p>On</p>  <p>Off</p>	 <p>On</p>  <p>Off</p>	 <p>On</p>  <p>Off</p>

1 The option sequence will start again from the Rinse Agent setting.

Cleaning the surfaces

Important!

We do not recommend the use of the following cleaning aids on/in your DishDrawer® as they may damage the surfaces:

- *Plastic or stainless steel scouring pads*
 - *Abrasive, solvent, household cleaners*
 - *Acid or alkaline cleaners*
 - *Hand washing liquids or soap*
 - *Laundry detergents or disinfectants*
 - *Proprietary 'Stainless Steel' cleaners or polishes as these may damage the protective coating.*
- 1 Wipe with a clean damp cloth. Take care not to wet the control panel.
 - 2 Dry with a clean lint-free cloth.

Cleaning the drain filter, spray arm and filter plate

We recommend that the drain filter is cleaned whenever there is evidence of food particles. The spray arm and filter plate may need cleaning about once a month in normal use or more often should the need arise.

If a dishwasher cleaner/descaler is used, you must run a wash program with detergent immediately afterward to prevent any damage to your DishDrawer®.

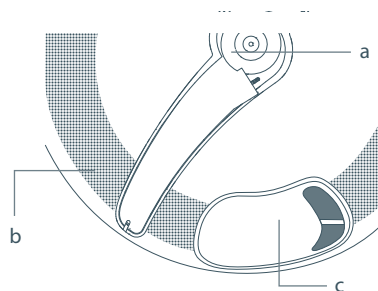

Internal parts of the DishDrawer®

- a Spray arm
- b Filter plate
- c Drain filter

Important!

The DishDrawer® must be used with the filter plate, drain filter and spray arm correctly in place.

Cleaning the drain filter

- 1 Lift up the drain filter access panel on the basket (if fitted).
- 2 Lift and remove the drain filter.
- 3 Empty, rinse clean under running water and replace back into the allocated space.
- 4 Ensure the drain filter is flush with the filter plate.

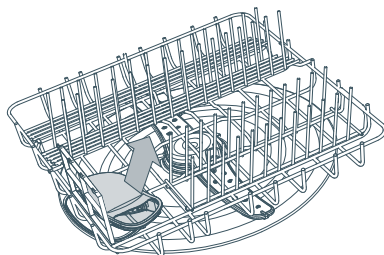
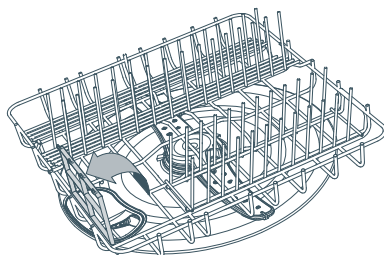

Cleaning the spray arm and filter plate

Ensure the DishDrawer® is cool before you start cleaning and follow the instructions for removing the drain filter and spray arm.

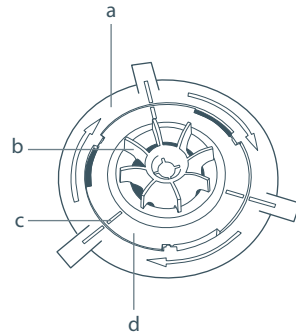
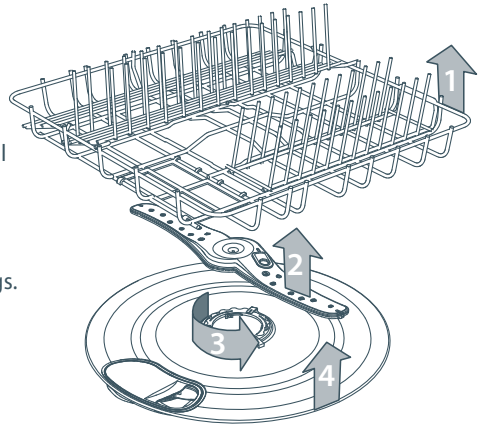

- 1 Remove the basket carefully. Lift from the back end first to prevent knocking the detergent and rinse agent dispenser.
- 2 Lift the spray arm and shake any foreign material out.
Rinse the spray arm clean under running water and wipe with a damp cloth.
- 3 In the center of the filter plate there are two rings. Hold the center ring still and turn the outer ring counter-clockwise, about a 1/8 turn. This will release the filter plate.
- 4 Lift the filter plate out.
When cleaning the underside of the filter plate, take care handling the sharp outer edge to avoid the risk of cuts.
Remove any foreign material, wash in hot soapy water and rinse thoroughly in clean water. The heater plate can be wiped with a damp cloth.
- 5 Replace the filter plate so it lies flat in the base of the drawer ensuring the filter plate is fully locked into position with the center ring.
- 6 To lock the filter plate into position, ensure the lines align with each other (refer to the diagram for the correct position). The filter plate must not be able to move about freely.
- 7 Replace the spray arm back onto the impeller.
- 8 Replace the basket, lowering the front edge of the basket into position first.



Correct locking position of filter plate with motor assembly (under spray arm)

- a Outer ring
- b Impeller
- c Correct alignment marks
- d Center ring

Note: Where there is broken crockery or glass in the drawer, it must be carefully removed to prevent damage to the DishDrawer®.

Problem	Possible Cause	What to do
Unclean dishes	Wash program unsuitable for the load.	Refer to the wash programs section for a suitable wash program, or the soils were too heavily baked on and dishes may need soaking.
	Spray arm unable to rotate.	Ensure no items are obstructing the spray arm path.
	DishDrawer® overloaded/incorrectly loaded.	Refer to the section on loading.
	Filter plate/drain filter is incorrectly inserted.	Refer to the care and cleaning section.
	Detergent put in the wrong compartment.	Detergent must be placed in the large compartment.
	Excess food not removed from dinnerware prior to loading.	Scrape all food scraps off dinnerware prior to loading.
	Unsuitable detergent.	Use recommended brands of dishwasher detergent. Only use powder detergent.
	Not enough detergent.	Refer to the detergent section or the detergent manufacturer's instructions.
	Spray arm holes are blocked.	Clean the spray arm.
	Filter plate/drain filter is blocked.	Clean the filter plate and drain filter.
	Mega rack incorrectly installed.	Refer to the accessories section for correct installation.
Foaming	Incorrect amount of detergent.	Refer to the detergent section or consult the detergent manufacturer's instructions.
	Too much egg in the wash load.	Increase the amount of detergent.
	Rinse agent setting too high.	Decrease the rinse agent setting.
Water leaking	Drain hose disconnected from waste pipe.	Reconnect the drain hose to the waste pipe.
	Supply inlet hose not properly connected.	Ensure the inlet hose is connected securely.
	Other leaks.	Turn water and power supplies to the DishDrawer® off. Call your dealer or Authorized Service Agent.
DishDrawer® will not open	Childlock function is on or the Closed Drawer option is on, or both.	Turn Lock off. Hold down the  button until the light above the  button disappears and/or press the  button to open the DishDrawer®.
Power failure during cycle.		Wait until power resumes, cycle will restart in same part of wash program.

Problem	Possible Cause	What to do
Continuous beeping	A fault has occurred.	Refer to the Fault codes section.
Intermittent beeping	DishDrawer® is in pause mode.	Close the DishDrawer® and press the ► button.
DishDrawer® will not start	Power supply is not connected.	Connect the power supply.
	The drawer is not closed properly.	Ensure the drawer is firmly closed.
	Lock feature is on.	Turn Lock off. Hold down the  button until the light above the  button disappears.
	► button not pressed.	Press the  button.
Excess water in the DishDrawer®	Drain hose(s) bent or kinked.	Straighten the drain hose(s).
	Blocked filters.	Clean the filter plate/drain filter. Refer to the Care and cleaning section.
Water marks on the dishes	Rinse agent depleted.	Refill the rinse agent dispenser.
	Rinse agent setting too low.	Increase the rinse agent setting.
	DishDrawer® overloaded/incorrectly loaded.	Refer to the section on loading.
DishDrawer® interior is stained	Some foods, like tomato based products, may stain the inside of the DishDrawer®.	Pre-rinse dishes before placing in the DishDrawer®. Alternatively, using the Rinse program after adding the dishes may minimize staining.
Dishes did not dry	Incorrect loading.	Ensure the dishes are not nesting together.
	Rinse agent depleted.	Refill the rinse agent dispenser.
	Rinse agent setting too low.	Increase the rinse agent setting.
	Eco wash program used.	Choose a standard wash program.
No detergent dispensed	Detergent dispenser was wet when loaded.	Clean the dispenser and ensure the dispenser is dry when adding detergent.
Excessive motor noise	The filter plate and/or spray arm is incorrectly placed.	Refer to the care and cleaning section for details on correct placement.
	No water in the motor area.	This usually occurs on the first use or when the DishDrawer® has not been used for long periods of time. Run the DishDrawer® through a wash program.



How to recognize a fault code









When a fault has occurred, the DishDrawer® will continuously beep every second.



The fault code will be displayed on the wash program selector.

Each fault code is shown in the following chart.

How to attend to a fault code

- 1 Press the  button to remove the fault code.
- 2 If the fault code and continuous beeps cannot be removed by pressing the  button, turn the DishDrawer® off at the power supply.
- 3 We recommend you check the following chart and correct the fault where possible.
- 4 After attending to the fault, turn the DishDrawer® on at the power supply.
- 5 If the fault code and continuous beeps remain, turn the water and power supply off to the DishDrawer®.
- 6 When calling your Authorized Service Center advise them of the fault code that has appeared on the DishDrawer®. This information will help the Authorized Service Center respond to your request.

Fault Codes	Possible Causes	What to Do
F1 	Flood switch has been activated.	Turn the water and power supply to the DishDrawer® off and call your Authorized Service Center.
F2 	Motor problem.	Call your Authorized Service Center.
F3 	Temperature sensor failed.	Ensure water coming in through the inlet hose is less than 149°F. You may need to install a tempering valve on your water supply.
F4 	Faulty temperature sensor or element	Call your Authorized Service Center.
F5 	Lid fault	1 Turn power supply to DishDrawer off, then turn on power supply. Fault may reset. 2 Call your Authorized Service Center.
F6 	Lid fault	1 Turn power supply to DishDrawer off, then turn on power supply. Fault may reset. 2 Call your Authorized Service Center.
F7 	Lid fault	Call your Authorized Service Center.
F8 	Electrical problem	1 Turn power supply to DishDrawer off. 2 Call your Authorized Service Center.
F9 	Electronics malfunction.	Call your Authorized Service Center.

Fault Codes	Possible Causes	What to Do
<p>U1</p>  <p>HEAVY NORMAL FAST DELICATE RINSE</p>	<p>Fill Fault</p>	<ol style="list-style-type: none"> 1 Turn the DishDrawer® water supply on. 2 Ensure the spray arm is placed on the impeller and can rotate and if the DishDrawer® is full of water, it will need to be emptied manually. 3 Call your Authorized Service Center.
<p>U2</p>  <p>HEAVY NORMAL FAST DELICATE RINSE</p>	<p>Loading</p>	<p>Check loading to ensure no items extend beyond the height of the drawer.</p>
<p>U4</p>  <p>HEAVY NORMAL FAST DELICATE RINSE</p>	<p>Fault in the other drawer preventing the use of this drawer</p>	<p>Check other drawer, attend to fault code on that drawer.</p>

Before you call for service or assistance ...

Check the things you can do yourself. Refer to the installation instructions and your user guide and check that:

- 1 Your product is correctly installed.
- 2 You are familiar with its normal operation.
- 3 If the circuit breaker tripped or the fuse blown.
- 4 If there is a power outage in the area.

If after checking these points and you still need assistance, please contact your local DCS authorized service agency or DCS Customer Care Representative for warranty service. Our number is (888) 281-5698. Please have the following information ready before you call:

- Model Number (can be found inside of the cabinet, bottom left of the top drawer)
- Serial Number (can be found inside of the cabinet, bottom left of the top drawer)
- Date of installation
- A brief description of the problem

Your satisfaction is of the utmost importance to us. If a problem cannot be resolved to your satisfaction, please email us at support@dcsappliances.com or write:

Fisher & Paykel Appliances, Inc.
Attention: DCS Customer Care
5900 Skylab Road
Huntington Beach, CA 92647

www.dcsappliances.com

Limited warranty

When you purchase any new Fisher & Paykel whiteware product for personal or consumer use you automatically receive a one year limited warranty covering parts and labor for servicing within the 48 mainland United States, Hawaii, Washington DC and Canada. In Alaska the limited warranty is the same except that you must pay to ship the product to the service shop or the service technician's travel to your home. Products for use in Canada must be purchased through the Canadian distribution channel to ensure regulatory compliance.

If the product is installed in a motor vehicle, boat or similar mobile facility, you receive the same one year limited warranty, but you must bring the vehicle, boat or mobile facility containing the product to the service shop at your expense or pay the service technician's travel to the location of the product.

Fisher & Paykel undertakes to:

Repair without cost to the owner either for material or labor any part of the product, the serial number of which appears on the product, which is found to be defective. In Alaska, you must pay to ship the product to the service shop or for the service technician's travel to your home. If the product is installed in a motor vehicle, boat or similar mobile facility, you must bring it to the service shop at your expense or pay for the service technician's travel to the location of the product. If we are unable to repair a defective part of the product after a reasonable number of attempts, at our option we may replace the part or the product, or we may provide you a full refund of the purchase price of the product (not including installation or other charges).

This warranty extends to the original purchaser and any succeeding owner of the product for products purchased for ordinary single-family home use.

All service under this limited warranty shall be provided by Fisher & Paykel or its Authorized Service Agent during normal business hours.

How long does this limited warranty last?

Our liability under this limited warranty expires ONE YEAR from the date of purchase of the product by the first consumer.

Our liability under any implied warranties, including the implied warranty of merchantability (an unwritten warranty that the product is fit for ordinary use) also expires ONE YEAR (or such longer period as required by applicable law) from the date of purchase of the product by the first consumer. Some states do not allow limitations on how long an implied warranty lasts, so this limit on implied warranties may not apply to you.

This warranty does not cover:

- A Service calls that are not related to any defect in the product. The cost of a service call will be charged if the problem is not found to be a defect of the product. For example:

1. Correct faulty installation of the product.
 2. Instruct you how to use the product.
 3. Replace house fuses, reset circuit breakers, correct house wiring or plumbing, or replace light bulbs.
 4. Correct fault(s) caused by the user.
 5. Change the set-up of the product.
 6. Unauthorized modifications of the product.
 7. Noise or vibration that is considered normal, for example, drain/fan sounds, regeneration noises or user warning beeps.
 8. Correcting damage caused by pests, for example, rats, cockroaches etc.
- B Defects caused by factors other than:
1. Normal domestic use or
 2. Use in accordance with the product's user guide.
- C Defects to the product caused by accident, neglect, misuse, fire, flood or Act of God.
- D The cost of repairs carried out by non-authorized repairers or the cost of correcting such unauthorized repairs.
- E Travel fees and associated charges incurred when the product is installed in a location with limited or restricted access. (eg airplane flights, ferry charges, isolated geographic areas).
- F Normal recommended maintenance as set forth in the product's user guide.

If you have an installation problem contact your dealer or installer. You are responsible for providing adequate electrical, exhausting and other connection facilities.

We are not responsible for consequential or incidental damages (the cost of repairing or replacing other property damaged if the product is defective or any of your expenses caused if the product is defective). Some states do not allow the exclusion or limitation of incidental or consequential damages, so the above limitation or exclusion may not apply to you.

You may be required to provide reasonable proof of the date of purchase of the product before the product will be serviced under this limited warranty.

Commercial use

If you are using the product in a commercial setting (any use other than a single family dwelling), we agree to repair or replace, without cost to you for parts only, any defective parts, the serial number of which appears on the product. Our liability for these repairs expires ONE YEAR from the date of original purchase.

At our option we may replace the part or the product, or we may provide you a full refund of the purchase price of the product (not including installation or other charges). All service under this limited warranty shall be provided by Fisher & Paykel or its Authorized Service Agent during normal business hours.

No other warranties

This limited warranty is the complete and exclusive agreement between you and Fisher & Paykel regarding any defect in the product. None of our employees (or our Authorized Service Agents) are authorized to make any addition or modification to this limited warranty.

Warrantor: Fisher & Paykel Appliances, Inc.

If you need further help concerning this limited warranty, please contact us at:

Fisher & Paykel Appliances, Inc.

5900 Skylab Road

Huntington Beach

CA 92647

This limited warranty gives you specific legal rights, and you may also have other rights which vary from state to state.