

KENWOOD

INTEGRATED ANSWERING TELEPHONE

IS-M20

CUSTOMER RELATIONS

INSTRUCTION MANUAL











KENWOOD CORPORATION

IMPORTANT. Carefully read and understand this manual before using the product.

© PRINTED IN JAPAN B62-0241-06
92/12 11 10 9 8 7 6 5 4 3 2 1 91/12 11 10 9 8 7

IMPORTANT SAFETY INSTRUCTIONS

When using your telephone equipment, basic safety precautions should always be followed to reduce the risk of fire, electric shock, and injury to persons, including the following:

1. Read and understand all instructions.
2. Follow all warnings and instructions marked on the product.
-  3. Unplug this product from the wall outlet before cleaning. Do not use liquid cleaners or aerosol cleaners. Use a damp cloth for cleaning.
-  4. Do not use this product near water, for example, near a bathtub, wash bowl, kitchen sink, or laundry tub, in a wet basement, or near a swimming pool.
5. Do not place this product on an unstable cart, stand or table. The product may fall, causing serious damage to the product.
-  6. Slots and openings in the cabinet and the back or bottom are provided for ventilation, to protect it from overheating. These openings must not be blocked or covered. The openings should never be blocked by placing the product on the bed, sofa, rug, or other similar surface. This product should never be placed near or over a radiator or heat register. This product should not be placed in a built-in installation unless proper ventilation is provided.
-  7. This product should be operated only from the type of power source indicated on the marking label. If you are not sure of the type of power supply to your home, consult your dealer or local power company.
-  8. Do not allow anything to rest on the power cord. Do not locate this product where the cord will be abused by persons walking on it.
-  9. Do not overload wall outlets and extension cords as this can result in the risk of fire or electric shock.
-  10. Never push objects of any kind into this product through cabinet slots as they may touch dangerous voltage points or short out parts that could result in a risk of fire or electric shock. Never spill liquid of any kind on the product.
-  11. To reduce the risk of electric shock, do not disassemble this product, but take it to a qualified serviceman when some service or repair work is required. Opening or removing covers may expose you to dangerous voltages or other risks. Incorrect reassembly can cause electric shock when the appliance is subsequently used.
12. Unplug this product from the wall-outlet and refer servicing to qualified service personnel under the following conditions:
 - A. When the power supply cord or plug is damaged or frayed.
 - B. If liquid has been spilled into the product.
 - C. If the product has been exposed to rain or water.
 - D. If the product does not operate normally by following instructions. Adjust only those controls, that are covered by the operating instructions because improper adjustment of other controls may result in damage and will often require extensive work by a qualified technician to restore the product to normal operation.
 - E. If the product has been dropped or the cabinet has been damaged.
 - F. If the product exhibits a distinct change in performance.
-  13. Avoid using this telephone (other than a cordless type) during an electrical storm. There may be a remote risk of electric shock from lightning.
-  14. Do not use the telephone to report a gas leak in the vicinity of the leak.

**SAVE THESE
INSTRUCTIONS**

FCC RULES AND REGULATIONS

1. This equipment complies with part 68 of the FCC rules. On the bottom of this equipment is a label that contains, among other information, the FCC registration number and ringer equivalence number (REN) for this equipment. If requested, this information must be provided to the telephone company.
2. This equipment connects to the network via USOC RJ11C.
3. The REN is used to determine the quantity of devices which may be connected to the telephone line. Excessive RENs on the telephone line may result in the devices not ringing in response to an incoming call. In most, but not all areas, the sum of the RENs should not exceed five (5). To be certain of the number of devices that may be connected to the line, as determined by the total RENs, contact the telephone company to determine the maximum REN for the calling area.
4. If the terminal equipment causes harm to the telephone network, the telephone company will notify you in advance. If advance notice isn't practical, the telephone company will notify you as soon as possible. Also, you will be advised of your right to file a complaint with the FCC, if you believe it is necessary.
5. The telephone company may make changes in its facilities, equipment, operations, or procedures that could affect the operation of the equipment. If this happens, the telephone company will provide advance notice in order for you to make the necessary modifications in order to maintain uninterrupted service.
6. If you experience trouble with this equipment, please contact us for repair and (or) warranty information at either:

Kenwood U.S.A. Corporation
Los Angeles Office and National Service Dept.
2201 East Dominguez Street
P.O. Box 22745
Long Beach, CA 90810-5745
PH: (213) 639-9000

or

Kenwood U.S.A. Corporation
New Jersey Office
550 Clark Drive
Mount Olive, NJ 07828

If the trouble persists and harms the telephone network, the telephone company may request

you remove the equipment from the network until the problem is solved.

7. This equipment cannot be used on public coin service provided by the telephone company. Connection to Party Line Service is subject to state tariffs. (Contact the State Public Utility Commission, Public Service Commission, or Corporation Commission for more information.)

The IS-M20 provides magnetic coupling for marking aids.

NOTE: In addition, one or more of the following FCC statements may be applicable to this equipment.

FCC GENERAL PRODUCT WARNING

This equipment generates or uses radio frequency energy. Changes or modifications to this equipment may cause harmful interference unless the modifications are expressly approved in the instruction manual. The user could lose the authority to operate this equipment if an unauthorized change or modification is made.

FCC DIGITAL DEVICE WARNING

This equipment has been tested and found to comply with the limits for a Class B digital device, pursuant to Part 15 of the FCC Rules. These limits are designed to provide reasonable protection against harmful interference in a residential installation. This equipment generates, uses, and can generate radio frequency energy and, if not installed and used in accordance with the instructions, may cause harmful interference to radio communications.

However, there is no guarantee that the interference will not occur in a particular installation. If this equipment does cause harmful interference to radio or television reception, which can be determined by turning the equipment off and on, the user is encouraged to try to correct the interference by one or more of the following measures:

1. Reorient or relocate the receiving antenna.
2. Increase the separation between the equipment and receiver.
3. Connect the equipment into an outlet on a circuit different from that to which the receiver is connected.
4. Consult the dealer for technical assistance.

TABLE OF CONTENTS

INTRODUCTION.....	1
FEATURES.....	2
IS-M20 CONTROLS.....	4
REAR CONNECTIONS AND CONTROLS.....	5
DIAL KEYS AND FUNCTION CONTROLS.....	6
SYSTEM CONTROLS.....	7
SETTING UP THE IS-M20.....	9
PRECAUTIONS.....	9
LOADING THE MICROCASSETTE.....	10
CONNECTING THE PHONE LINE AND CURL CORD.....	12
POWERING THE IS-M20.....	13
SETTING UP THE DIAL MODE.....	14
ADJUSTING THE RINGER AND SPEAKER VOLUME.....	15
SETTING THE TIME AND DAY STAMP.....	15
IS-M20 AS A PHONE.....	17
MAKING AND RECEIVING A CALL.....	17
MAKING AND RECEIVING A CALL IN THE MONITOR MODE.....	17
PLACING A CALL ON HOLD.....	17
USING REDIAL AND AUTO REDIAL.....	18
USING SPEED DIALING.....	19
USING TONE SIGNALS.....	21
IS-M20 AS AN ANSWERING MACHINE.....	22
RECORDING A NORMAL GREETING MESSAGE.....	23
RECORDING A DIALOGUE GREETING MESSAGE.....	24
SETTING MAXIMUM RECORDING TIME.....	25
SETTING THE RINGER COUNTER.....	25
ACTIVATING AUTO-ANSWER.....	26
NORMAL RECORDING OF A RECEIVED MESSAGE.....	26
DIALOGUE RECORDING OF A RECEIVED MESSAGE.....	27
SCREENING CALLS (WITHOUT AUTO-ANSWER).....	27
PLAYING BACK MESSAGES.....	28
ERASING MESSAGES.....	29
USING SECRET CALL.....	30
ENTERING A SECRET CALL CODE.....	30
ACTIVATING SECRET CALL.....	31
DEACTIVATING SECRET CALL.....	31
REMOTE FEATURES.....	32
ENTERING OR DELETING A REMOTE ACCESS CODE.....	32
USING TOLL SAVER COUNTER.....	33
PLAYING BACK MESSAGES (AUTO-ANSWER IS ON).....	33
ACTIVATING AUTO-ANSWER.....	34
IN CASE OF DIFFICULTY.....	34

IS-M20

INTRODUCTION

Thank you for purchasing a Kenwood IS-M20. You've chosen a product that has the newest advanced telephone features, all packaged in a sleek, sculpted design that will easily complement your home decor.

The IS-M20 is more than a conventional telephone answering system. Along with its many features, we've also included several unique conveniences, like Secret Call, Voice-Synthesized Messages, Time and Day Stamp, Remote Retrieval, and Speed Dial Memories.

To immediately start using your new IS-M20, first read the pages that illustrate the features and list of parts (starting with page 2). Then, follow the instructions in *Setting Up the IS-M20* on page 9 to place your new telephone into service.

However, before you begin using the IS-M20, may we suggest you take a few moments to read the remainder of the manual to quickly gain an overall understanding of system concepts. With this approach, you'll be able to more quickly enjoy the benefits afforded by the sophisticated features inherent in our design.

Once you've installed your IS-M20, be sure to fill out and return the Registration Card. For your added convenience, we've included two quick reference cards that summarize the IS-M20 operating modes. Keep the larger card near your telephone and carry the smaller one with your personal credit cards.

FEATURES

We've designed the IS-M20 Integrated Answering Telephone to be a powerful, yet simple, integrated product. It is both a telephone and an answering machine, all cleverly contained in a package that is smaller than a conventional desk telephone.

To use it as a telephone, simply pick-up the Handset and make or receive calls.

To use it as an answering machine, press the ANSWER SYSTEM button to automatically answer calls with your greeting message and record the caller's response on the hidden microcassette. To hear your messages, press and hold down the ANSWER SYSTEM button for two seconds, which immediately informs you of the number of messages received before automatically playing them back for you.

You can also retrieve your messages remotely by simply entering code numbers via dial keys at remote locations.

To learn how to use the features in greater detail, we encourage you to read the remaining pages. There you'll learn how to use your new Integrated Answering Telephone to its fullest potential.

CHECK LIST OF SUPPLIED PARTS

Your IS-M20 has been carefully packed at the factory. Nevertheless, you should check that you received the following items with your package.



▼ Handset

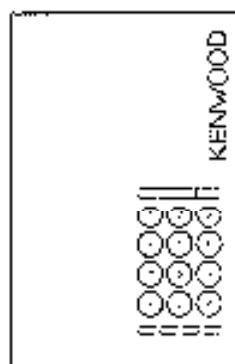

▼ Receiver

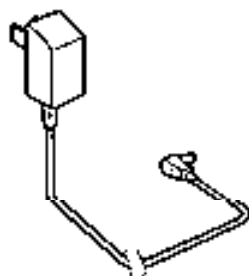

▼ AC adapter
(DCK-250)

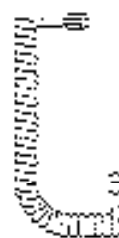

▼ Curl Cord

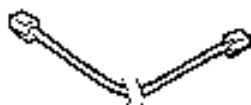

▼ Phone Cord



▼ Microcassette
(MC-60)

- ▼ Two Quick Reference Cards (different sizes)
- ▼ Registration Card
- ▼ Warranty Information Card

If any of these items are missing, please contact the dealer where you purchased the product.

Features

IS-M20 CONTROLS

The IS-M20's ergonomic design purposely organizes the controls and connections into several distinct areas, as shown in Figure 1.

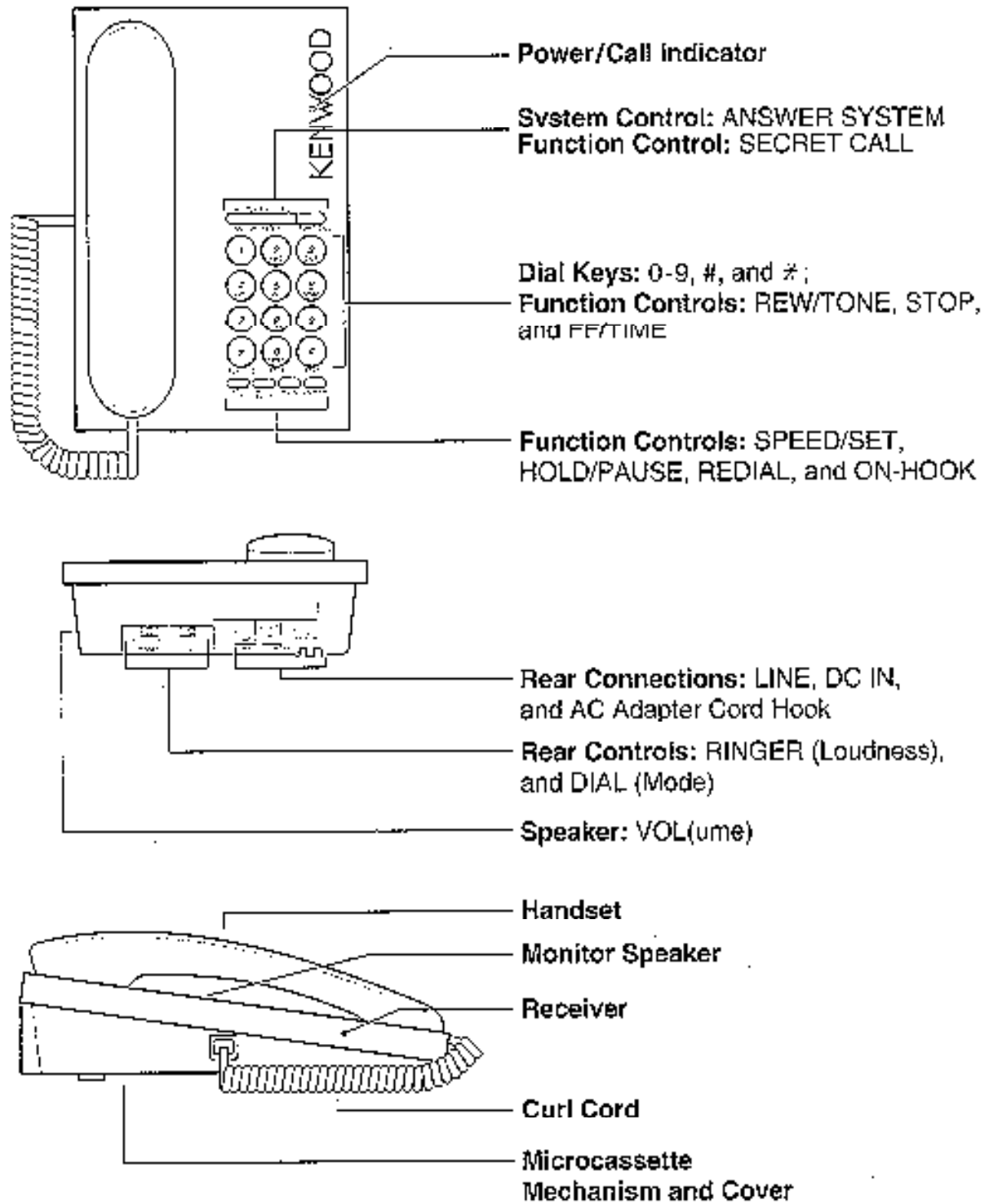

Figure 1. IS-M20 controls and connections.

.....

They include Rear Connections and Controls, Dial Keys and Function Controls, and System Controls. The IS-M20 also includes Curl Cord connections, a Microcassette Mechanism with Cover, and Volume Control.

This section explains the function of each of these items. When you finish reading these pages, move to the next section, where you'll learn how to install your IS-M20.

REAR CONNECTIONS AND CONTROLS

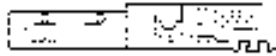

At the rear of the IS-M20 are connection jacks for telephone line and dc power, and controls for Ringer Loudness, and Dial Mode. A hook to fasten the ac adapter cord is also included here. (See page 14 for operation details.)

LINE - The telephone line cord (from wall) plugs in here.

DC IN - The dc output plug from the supplied ac adapter (Kenwood Model No. DCK-250) plugs in here. This connection provides power to the IS-M20.

RINGER - Slide control for setting the telephone's ringer volume to HIGH, LOW, or OFF.

DIAL - Slide control for selecting either PULSE (standard) or TONE (generated) dial tones. Consult your local phone company to find out which type of system you are using.

AC Adapter Cord Hook - Use this hook to fasten the ac adapter cord to the IS-M20 base. This will help prevent accidental disconnection of power when you move the telephone.

DIAL KEYS AND FUNCTION CONTROLS

In addition to the standard 12 Dial Keys, the IS-M20 provides five System and Function Controls that are divided into two rows above and below the Dial Keys. Also, the bottom row of Dial Keys doubles as Function Controls during certain operating modes.

DIAL KEYS



Use Dial Keys 0 through 9 to enter telephone numbers. Use the * Dial Key to send Tones and use the # Dial Key to check the Time and Day Stamp (see *Function Controls, FF/TIME* on page 7).

FUNCTION CONTROLS

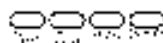

SPEED/SET - Pressing this button followed by a Dial Key number (0 through 9) lets you instantly Speed Dial a phone number stored in any one of the ten Speed Dial Memories. Alternately, this button functions as a Set control for entering numbers into Speed Dial Memory locations. (See page 19 for operation details.)

HOLD/PAUSE - When using the telephone, pressing this button puts your caller on hold. When entering numbers into a Speed Dial Memory, pressing this button puts a pause in the number sequence. (See page 20 for operation details.)

When recording a Dialogic Greeting message, pressing this button inserts a pause into the message. (See page 24 for operation details.)

REDIAL - Pressing this button lets you redial the last number called. When used in the Auto Redial mode, the last number can be redialed up to nine times. (See page 18 for operation details.)

ON-HOOK - Pressing this button lets you listen to your caller without having to use the Handset. (See page 17 for operation details.)

FUNCTION CONTROLS



REW/TONE -While playing back your messages, pressing this button (*) rewinds the microcassette. (See page 28 for operation details.)

Otherwise, pressing this button lets you send Tones even though your telephone may be set for Pulse operation. (See page 21 for operation details.)

STOP - When playing back your messages, pressing this button (□) stops the microcassette. (See page 26 for operation details.)

FF/TIME - When playing back your messages, pressing this button (#) winds the microcassette forward. (See page 28 for operation details.)

Otherwise, pressing this button lets you hear the current Time and Day Stamp. (See page 15 for operation details.)



SECRET CALL- Pressing this button for more than two seconds puts the IS-M20 into the Secret Call Mode. Only callers who know your Secret Code, will be able to ring through your system. An adjacent lit green LED indicator confirms your selection. (See page 30 for operation details.)

SYSTEM CONTROLS

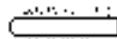

The IS-M20 Integrated Answering System controls are integrated into a simple-to-use "smart" ANSWER SYSTEM button. This button lets you engage Auto-Answer or Playback modes, or record a Greeting Message.

ANSWER- Pressing the ANSWER SYSTEM button (with Handset in Cradle) places the IS-M20 into the Auto-Answer mode. An adjacent lit green LED indicator confirms your selection. (See page 26 for details.)

PLAY- Pressing and holding down the ANSWER SYSTEM button for two seconds (with Handset in Cradle) engages the playback mode. The IS-M20 informs you of the number of received messages before automatically playing them back for you. An adjacent lit green LED indicator confirms your selection. (See page 28 for details.)

© 1991 AT&T

REC - Pressing the ANSWER SYSTEM button and lifting the Handset lets you record your Greeting Message over the Handset. (See page 23 for operation details.)

Power/Call Indicator - A red LED lights when power is on. This indicator turns green when you place a call, and will flash (green) simultaneously with the Ringer Tone when someone calls you.

**CURL CORD
CONNECTIONS**

You connect the supplied Curl Cord between the jacks on the IS-M20 Receiver and Handset.

**MICROCASSETTE
MECHANISM AND
COVER**

Located on the bottom of the IS-M20 Receiver is the Microcassette Mechanism for recording your messages on the supplied MC-60 Microcassette.

**SPEAKER
VOLUME**

Located on the side of the IS-M20, the VOL(ume) slide control lets you set the speaker volume for use in Monitor and Answering modes.

SETTING UP THE IS-M20

In this section, you'll learn how to install and setup your IS-M20 Integrated Answering Telephone.

You should plan to connect your IS-M20 near an open phone jack and an available ac outlet in your home.

After you've completed these instructions, read the next section, to learn how to use the IS-M20 as a telephone.

PRECAUTIONS

In addition to the Important Safety Instructions listed at the beginning of this manual, please be aware of the following precautions before you set up your IS-M20:

- ▼ You must connect the supplied ac adapter to a power supply outlet (120 V ac) to use the IS-M20. Make sure it is firmly plugged into the ac outlet.

NOTE: Disconnecting the ac adapter or losing ac power will cease IS-M20 operation. If power is off for more than three hours, the IS-M20 will lose all stored data and return to its initial settings.



- ▼ Do not connect or disconnect the ac adapter with wet hands, as you could get an electric shock.
- ▼ If the phone line suffers voltage dropouts, noise interruptions, etc., your IS-M20 may not work properly. If this should happen, contact your dealer.
- ▼ Do not use IS-M20 as a community phone, public phone, regional group phone, or with a data circuit.
- ▼ Do not alter the DIAL mode (see page 14) after it has been set. Altering it may result in disconnection (the line is cut off) or the wrong number being dialed.
- ▼ If two or more telephones are connected to the same line, one telephone may ring while dialing the other. This is not a product defect.
- ▼ Use only the supplied ac adapter (Kenwood Model No. DCK-250). Do not substitute another brand which may have different ratings.



- ▼ Do not place the IS-M20 where it is exposed to direct sunlight, high temperatures, high humidity, poor ventilation, frequent vibration, next to a television or stereo amplifier, or near magnetic fields.
- ▼ Never disassemble or modify the phone. If water or a object (e.g., a pin) gets inside the phone, unplug the ac adapter immediately and contact your dealer.
- ▼ Wipe the IS-M20 exterior only with a soft, dry cloth. If extremely dirty, wipe it with a soft, damp cloth soaked in a diluted, neutral detergent; then wipe it with a dry cloth. Do not use benzine, thinner, or alcohol, as they will damage the surface finish.

STEP 1 LOADING THE MICROCASSETTE

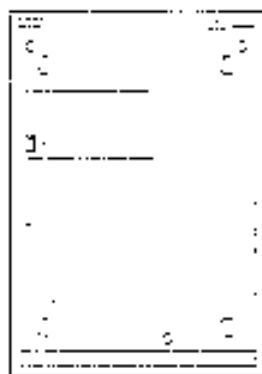

Figure 2. Bottom of IS-M20.

Before connecting the IS-M20 to the phone line and ac adapter, load the supplied MC-60 microcassette by performing the following instructions:

- a. Position the IS-M20 Receiver so that the bottom faces you, as shown in Figure 2.
- b. Push the Open/Close hook on the microcassette cover in the indicated direction, and lift the cover, as shown in Figure 3.

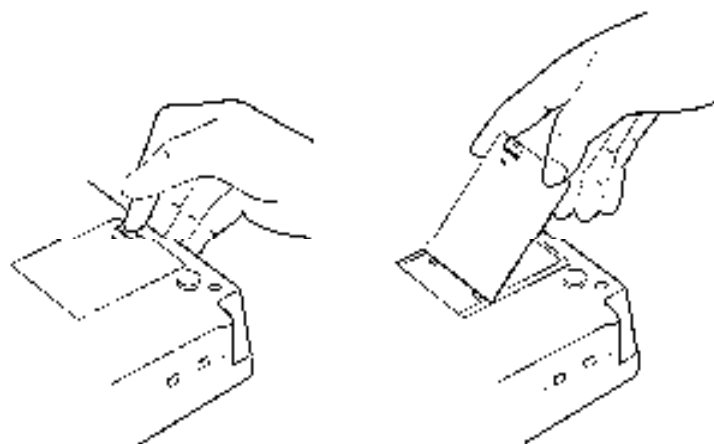

Figure 3. To access the microcassette mechanism, push the open/close hook (left drawing) to release the cover and lift it up.



Figure 4. Inserting microcassette into mechanism chamber.

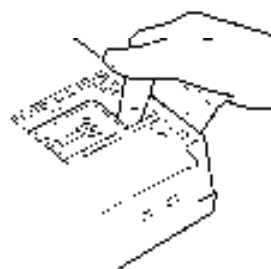

Figure 5. To remove the microcassette, pull out the edge.

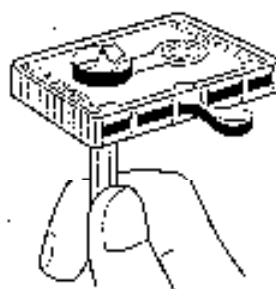

Figure 6. If tape is pulled out, use a pencil (as a spindle) to pull it back into shell.

- c. With the A side facing upwards, insert the microcassette into the mechanism chamber by first placing the shell's back against the wall, and then pressing the microcassette down, as shown in Figure 4.

NOTE: To remove the microcassette, pull out the edge with your finger, as shown in Figure 5.

- d. Replace the microcassette cover (see Figure 2) and press down on it to lock the cover.

NOTE: Make sure the Microcassette Cover is securely closed; otherwise the microcassette may come out while the tape is running and cause a failure.

When the IS M20 is powered on, the loaded microcassette is automatically rewound to the start of tape, no matter which side is being used.

The tape will wear, so use both sides to extend its life. For best performance, replace the microcassette with a new one every six months. Use only a normal type MC-30 or MC-60 microcassette. Do not use MC-15, MC-90, Metal or Chrome microcassettes.

IMPORTANT: When replacing a microcassette (or using the other side), you must record your greeting message again. (Refer to *Using the IS-M20 as an Answering Machine* on page 22.)

If the tape in the microcassette shell is loose or has been pulled, try tightening it with a pencil, as shown in Figure 6. If there is slack in the tape, it may become entangled and cause a failure.

To insure quality recordings free of dropouts, muffled sound or warbled sound, periodically clean the head, capstan, and pinch roller with a cotton swab dipped in a mild cleaning solution, as shown in Figure 7 (next page). Ask your Kenwood dealer for recommended cleaners.

NOTE: Keep all microcassettes out of direct sunlight, high temperatures, high humidity, and away from dust and places subject to strong magnetic fields.

STEREOPHONIC
RECORDING

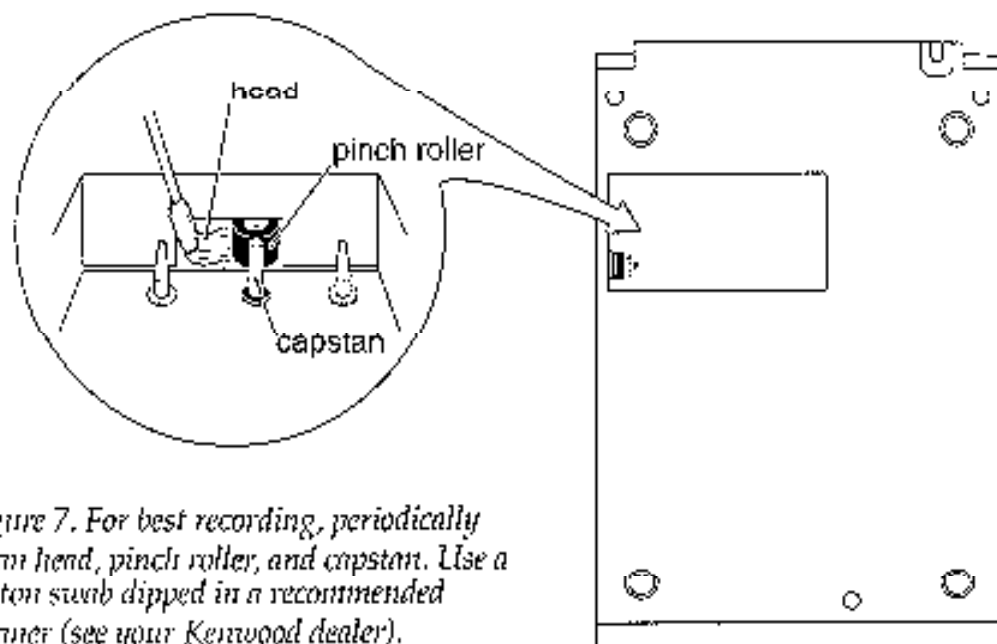

Figure 7. For best recording, periodically clean head, pinch roller, and capstan. Use a cotton swab dipped in a recommended cleaner (see your Kenwood dealer).

STEP 2 CONNECTING THE PHONE LINE AND CURL CORD

- a. Connect the Receiver and the Handset with the Curl Cord, as shown in Figure 8. You'll hear a click when you've inserted the plugs properly.
- b. Insert one end of the supplied Phone Cord into the socket marked LINE on the rear of the IS-M20 (see Figure 8).
- c. Insert the other end of the Phone Cord into the open phone jack.

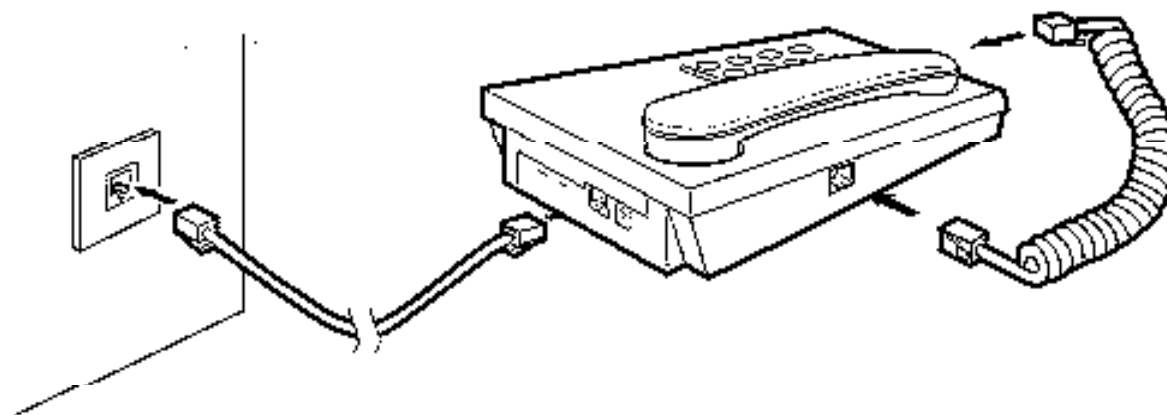

Figure 8. Hooking up the Phone and Curl Cords to the IS-M20.

STEP 3 POWERING THE IS-M20

- a. Insert the supplied ac adapter into a power outlet (120 V ac), and insert the plug (on its attached cord) into the jack labelled DC IN, as shown in Figure 9. After three seconds, initialization will begin.

NOTE: The supplied ac adapter is designed to be used only with the IS-M20. Do not connect it to other phones or equipment. When connecting the ac adapter, make sure it is inserted properly, without straining the wires.

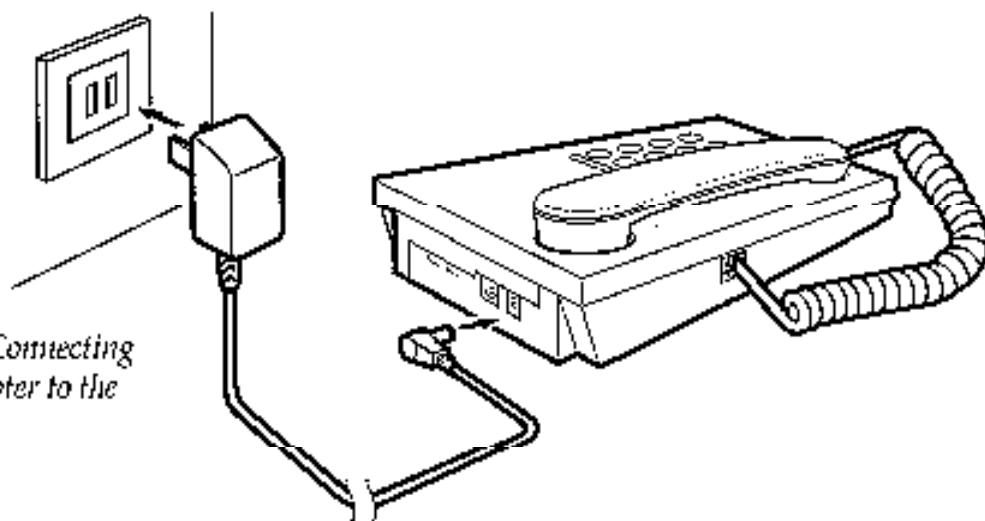

Figure 9. Connecting the ac adapter to the IS-M20.

- b. Immediately, the Call/Power indicator will light (red), and the ANSWER, PLAY, REC, and SECRET CALL indicators will start flashing. You'll hear the microcassette tape rewind to the start.
- c. When the microcassette has stopped, briefly pick up the Handset and set it back into the Cradle. This action will clear the flashing indicators, allowing you to use fully use the phone.

NOTE: If the tape is still rewinding, it is possible to make a phone call without waiting for the tape to reach the start. When you pick up the Handset, the tape will stop and then resume rewind when you place the Handset back in the Cradle. However, the microcassette tape must be fully rewound; otherwise it will not be possible to use the answering mode or record a message.

- d. Secure the ac adapter cord to the IS-M20 by looping it to the hook at the rear edge of the Receiver, as shown in Figure 10.

Figure 10. Securing the ac adapter cord to the IS-M20.

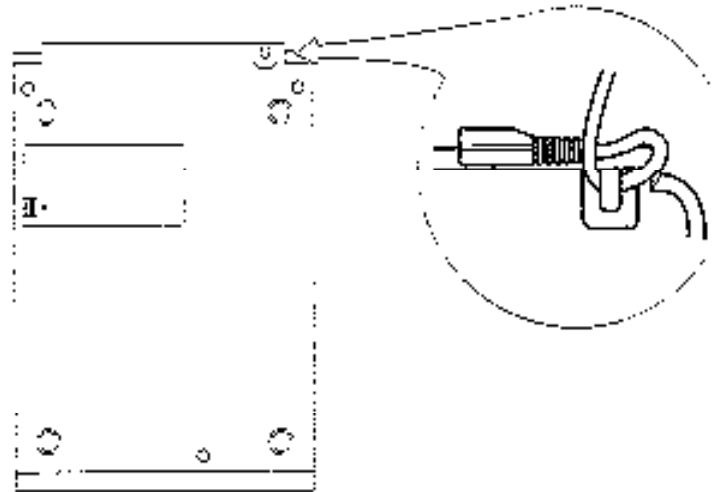

STEP 4 SETTING THE DIAL MODE

- a. Locate the DIAL mode switch on the rear of the IS-M20 Receiver, as shown in Figure 11.
- b. Select either PULSE or TONE modes, to match the phone line in use. If you're not sure what kind of line you have, ask the local phone company customer service representative for this information.

NOTE: If you select the wrong DIAL mode, you will not hear the number being dialed over the Handset. If this occurs, hang-up the Handset, move the DIAL mode switch to the other position, and try dialing again.

Figure 11. Rear view of the IS-M20.

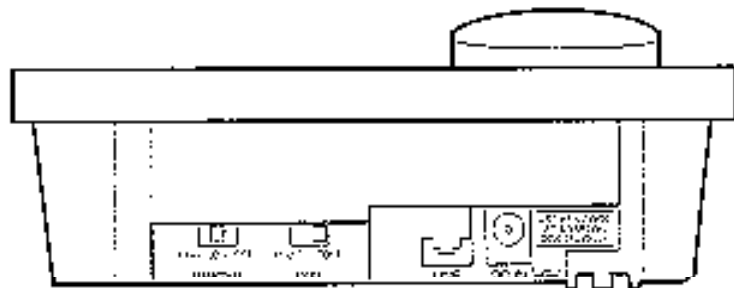

STEP 5 ADJUSTING THE RINGER AND SPEAKER VOLUME

- a. To adjust the loudness of the Ringer, locate the RINGER Control (see Figure 11). Select HIGH for a loud ring, LOW for a quiet ring, or OFF for no ring.

NOTE: If OFF is selected, the Power/Call indicator will still flash with each ring to let you know someone is calling.

- b. To adjust the Monitor Speaker Volume, locate the VOL control. Slide it to the right (side view) to increase volume, or to the left to decrease volume.

NOTE: To silence the Monitor Speaker, slide the VOL control all the way to the left.

STEP 6 SETTING THE TIME AND DAY STAMP

When properly set, your IS-M20 will "Time and Day Stamp" the end of each received message with a voice-synthesized announcement of the day of the week and the time the message was recorded.

- a. While holding down the SPEED/SET button, press #, followed by 7 to enter a new Time and Day Stamp.

NOTE: When you initially power on the IS-M20, Sunday 12:00 AM is automatically set as Time and Day Stamp.

- b. Continue holding down the SPEED/ SET button and enter the current day of the week by pressing a dial key (0-9) that corresponds to the following day codes:

1 = Sunday	4 = Wednesday	6 = Friday
2 = Monday	5 = Thursday	7 = Saturday
3 = Tuesday		

NOTE: If you enter a number other than one through seven, you will hear an error sound (i.e. three short beeps) when you release SPEED/SET button in a later step.

- c. Continue holding down the SPEED/ SET button and enter the current (military) time in hours and minutes (refer to Figure 12 on the next page). If you enter a nonexistent time (e.g., 2700), you will hear an error sound (i.e. three short beeps) when you release the SPEED/SET button in the next step.

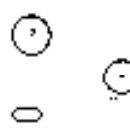

TIME
Standard Military

12 AM	0000
1 AM	0100
2 AM	0200
3 AM	0300
4 AM	0400
5 AM	0500
6 AM	0600
7 AM	0700
8 AM	0800
9 AM	0900
10 AM	1000
11 AM	1100
12 PM	1200
1 PM	1300
2 PM	1400
3 PM	1500
4 PM	1600
5 PM	1700
6 PM	1800
7 PM	1900
8 PM	2000
9 PM	2100
10 PM	2200
11 PM	2300

Figure 12. A chart showing standard and military time.

NOTE: Since military time uses a 24 hour clock, either 0000 or 2400 can be entered to set the time at 12 AM.

- d. Release the SPEED/SET button, and you will immediately hear the entered Time and Day Stamp from the Speaker. If needed, repeat the above steps to correct the day or time.

As an example, let's set the Time and Day Stamp for Monday 6:35 PM. Hold down the SPEED/SET button, and sequentially press # and 7. Next, press 2 (for Monday), and 1, 8, 3, 5 (for a military time of 18:35 that equals 6:35 PM). Release the SPEED/SET button and you should hear "Monday... Six, Thirty-Five...PM."

NOTE: The day and time are set as soon as the SPEED/SET button is released. You can use this feature to accurately set the Time and Day Stamp while observing a known time clock or watch.

- e. Whenever you want hear the current Time and Day Stamp, simply press # (FF/TIME).

NOTE: You will not hear the Time and Day Stamp while on the phone or while the microcassette tape is running.

IS-M20 As A PHONE

In this section you will learn how to use the IS-M20 Integrated Answering Telephone as a telephone. Here you will find out how to make and receive calls, use the redial modes, and make calls with the Speed Dial Memories. In the next section you will learn how to use the IS-M20 as an Answering Machine.

MAKING AND RECEIVING A CALL

1. The IS-M20 works like a standard telephone. When making a call, the Power/Call indicator flashes green.
 2. When someone calls you, the Power/Call indicator flashes green in time with the Ringer to provide a visual alert of an incoming call.
-

MAKING AND RECEIVING A CALL IN THE MONITOR MODE

1. To make or receive a call in the Monitor mode, leave the Handset in the Cradle and press the ON HOOK button. Once you hear your party's voice, you must pick up the Handset to continue the conversation.

NOTE: To go back to the Monitor mode (e.g., waiting while on hold), first press the ON HOOK button, and then place the Handset back into the Cradle.
 2. You can also end a call in the Monitor mode (or if you reach a busy line or no one answers) by pressing the ON HOOK button to disconnect the line. The Power/Call indicator will become red.
-

PLACING A CALL ON HOLD

1. During a phone conversation you can place your party on hold by pressing the HOLD/PAUSE button. You will see the Power/Call indicator start flashing green.

NOTE: During Hold you can place the Handset into the Cradle and not disconnect your party.
-

2. To release Hold, press the HOLD/PAUSE button a second time, or lift the Handset from the Cradle. If you want to switch to the Monitor mode during Hold, simply press the ON HOOK button. If your home system is equipped with other phones on the same line, the IS-M20 will release Hold as soon as you pick up another phone Handset.

NOTE: Hold will be automatically cancelled if the other party hangs up while on Hold. However, depending on the type of line you have, Hold may not be cancelled in this way. To be sure, simply lift the Handset and replace it.

USING REDIAL AND AUTO REDIAL

The Redial function memorizes the last number dialed and allows you to redial the number by pressing the REDIAL button. Use this feature when the other party is out, or the line is busy.

The Auto Redial function can be set to automatically redial the last number up to nine times at one-minute intervals when the line is busy.

Both Redial and Auto Redial functions can be used as many times as you want, until a new number is dialed.

MAKING A CALL USING REDIAL

1. Pick up the Handset or press ON HOOK.
2. Press the REDIAL button. Immediately the IS-M20 will dial the last dialed number.

NOTE: To check the number stored in Redial memory, first press the SPEED/SET button. Then press the REDIAL button. Immediately you will hear the stored number. If the last number called has more than 32 digits, only the first 32 digits will be remembered.

MAKING A CALL USING AUTO REDIAL

1. Leave the Handset in Cradle.
2. Press the REDIAL button, and then enter the number of times you want the number redialed (i.e., enter 1 through 9).

- *NOTE: You will hear an error signal (i.e., three short beeps) if you enter a number other than 1 through 9 (e.g., 0).*
- 3. The REDIAL indicator (in the button) will start flashing, and after one minute, the last number will be automatically redialed. At this point, the IS-M20 will enter the Monitor mode, and the Power/Call Indicator will turn green.
- 4. When the line is connected, lift the Handset to continue the conversation.
 - *NOTE: If the line is busy, you'll hear the busy signal three times before Auto Redial disconnects the line to try another redial. If there is no answer, the line will automatically become disconnected after ten rings, and dialing will start again after one minute. Redialing will be repeated every minute, up to the number of times set (1 - 9), or until the call is answered.*
- 5. To cancel Auto Redial at anytime, either lift the Handset or press ON HOOK. Auto Redial will automatically cancel when the call is connected, or when the set number of redials (1 - 9) is reached.

Telephonic

USING SPEED DIALING

STORING A NUMBER IN SPEED DIAL MEMORY

For your convenience, the IS-M20 is equipped with ten Speed Dial Memories. You can store a phone number with up to 32 digits in Speed Dial 0 and others having up to 14 digits in Speed Dials 1 through 9.

1. Leave the Handset in Cradle.
2. While holding down the SPEED/SET button, first enter Speed Dial memory location by pressing the corresponding dial key (0-9).
3. Continue holding down the SPEED/SET button, and enter the phone number you wish to store. The phone will beep each time you press a dial key.

NOTE: Enter each number within five seconds of the previous one; otherwise you will hear an error sound. Should this occur, start again with step 2.

4. Release the **SPEED/SET** button and you immediately will hear the number stored at that Speed Dial Memory location.

*NOTE: To check the number stored at Speed Dial location, first press the **SPEED/SET** button, followed by a desired memory location number (0-9). You will hear the current number stored at that location.*

5. To correct or replace the stored number, repeat above steps 1 through 4.

*NOTE: Pressing the **HOLD/PAUSE** button during Speed Dial number entry will put a three-second pause between digits. A pause counts as one digit.*

MAKING A SPEED DIAL CALL

1. Pick up the Handset or press the **ON HOOK** button for the Monitor mode.
2. Press the **SPEED/SET** button and within five seconds, press a desired Speed Dial Memory location number (i.e., 0-9).
3. Immediately the phone number stored at that location will be "speed" dialed.

*NOTE: To check the number stored at Speed Dial location, first press the **SPEED/SET** button, followed by a desired memory location number (0-9). You will hear the current number stored at that location.*

4. Begin speaking when the line is connected.

NOTE: Speed dialing can also be used in conjunction with conventional dialing. For example, you can send a stored credit card number after manually dialing a call.

USING TONE SIGNALS

The IS-M20 allows you to send tones (e.g., to access computer services), even if your phone must be set for Pulse dialing to match the community system (e.g., rural location or apartment complex). Also refer to *Setting Up the IS-M20* on page 9.

1. Pick up the Handset, or press the ON HOOK button.
2. Dial the number of the desired service (e.g., bank).
3. When the line is connected, press * to initiate the Tone mode.
4. Press additional dial keys according to the instructions provided by the service.

NOTE: After the call is disconnected, the IS-M20 will return to Pulse Dialing.

IS-M20 As An ANSWERING MACHINE

In today's society, most people feel that an answering machine is an indispensable device to let them record callers' messages for playback at a later time.

The IS-M20 can answer and record messages in two different ways: *Normal Recording and Dialogue Recording.*

In **Normal Recording**, the caller's message is recorded after the greeting message has been played and the beep has been sounded.

In **Dialogue Recording**, anything the caller says while the greeting message is playing is being recorded. So, even if the caller hangs up without leaving a message, he or she can be recognized from his (her) voice. The IS-M20 automatically switches to Dialogue Recording if there is a pause in the greeting message.

The way the received message is recorded depends on how the greeting message is recorded. If a pause is left in the greeting message (**Dialogue Greeting**), the received message will be recorded, using **Dialogue Recording**. If there is no pause (**Normal Greeting**), **Normal Recording** will be used.

Many states have imposed regulations on the manner in which two-way telephone conversations may be recorded. Consult your local telephone company.

The IS-M20 also features a **Non-Record Mode**, which only plays back the greeting message, without recording the caller's response.

In this section, you will learn how to use the IS-M20 Integrated Answering Telephone as an Answering Machine in all modes. Here you will find out how to record a greeting message, set up Auto-Answer, as well as record and playback received messages.

In the following sections, you will learn how to use Secret Call and the remote capabilities of the IS-M20 to retrieve your messages from other locations.

RECORDING A NORMAL GREETING MESSAGE



1. Press and hold down the ANSWER SYSTEM button until you pick up the Handset. The ANSWER and REC indicators will start flashing. You will hear "Please Wait" from the Speaker.
2. When you hear a beep, immediately begin announcing your greeting message into the Handset. During this time, you'll see the REC indicator continue flashing, but at a much slower rate.

NOTE: The maximum recording time is 12 seconds. If your message exceeds the maximum recording time, a beep will sound, and recording will immediately stop.

3. When you have finished announcing your greeting message, press STOP (0).

NOTE: Even though replacing the Handset at this point will also stop recording, we don't recommend this method, since the sound of the "hang-up" will also be recorded.

4. Continue holding the Handset as the IS-M20 plays back your recorded greeting message.

NOTE: If you want to replace the recorded greeting message, simply "hang-up" the Handset and repeat steps 1 through 4 until you record a satisfactory greeting message.

5. When you're finished recording, place the Handset back in the Cradle. Notice that all indicators (except Power/Call) go off.

NOTE: If the Handset is placed back in the Cradle, or the On-Hook lever is pressed during recording, the recording will stop immediately. At this point you'll have to begin with step 1 again.

RECORDING A DIALOGUE GREETING MESSAGE



1. Press and hold down the ANSWER SYSTEM button until you pick up the Handset. The ANSWER and REC indicators will start flashing. You will hear "Please Wait" from the Speaker.
2. When you hear a beep, immediately begin announcing your greeting message into the Handset. During this time, you'll see the REC indicator continue flashing, but at a much slower rate.

NOTE: The maximum recording time is 12 seconds. If your message exceeds the maximum recording time, a beep will sound, and the recording will immediately stop.

3. Press the HOLD/PAUSE button at the point where you want to insert a pause. You will hear the beep again. After the beep, continue announcing the remainder of the greeting.

NOTE: Only one pause is allowed during the recording.

4. When you have finished announcing your greeting message, press STOP (0).
5. Continue holding the Handset as the IS-M20 plays back your recorded greeting message.

NOTE: If you want to replace the recorded greeting message, simply "hang up" the Handset and repeat steps 1 through 2 until you record a satisfactory greeting message.

6. When you're finished recording place the Handset back in the Cradle. Notice that all indicators (except Power/Call) go off.

NOTE: If the Handset is placed back in the Cradle or the On-Hook lever is pressed during recording, the recording will stop immediately. At this point you'll have to begin with step 1 again.

SETTING MAXIMUM RECORDING TIME



You can set the IS-M20 to record messages for three different maximum lengths: one minute, two minutes, or as long as a caller speaks (voice-activated), up to the full length of a tape side. The default setting is the voice-activated mode.

1. Leave the Handset in the Cradle.
2. Hold down the SPEED/SET button, and then press #, followed by 3.
3. Continue holding down the SPEED/SET button and press 0, 1, or 2 to enter a corresponding Maximum Recording Time of zero, one or two minutes, or press 3 for voice-activated recording up to the full length of a tape side.

NOTE: Entering 0 for the record length places the IS-M20 into a Non-Record mode in which only the greeting message is played and the response is not recorded.

4. Release the SPEED/SET button, and you'll hear an announcement confirming your choice.
5. To check the Maximum Recording Time, first press the SPEED/SET button, followed by #, then 3.

NOTE: If you want to change the Maximum Recording Time, just repeat the above steps.

SETTING THE RINGER COUNTER



You can set IS-M20 to answer a call after two to six rings. The default setting is two rings.

1. Leave the Handset in the Cradle.
2. Hold down the SPEED/SET button, and then press #, followed by 4.
3. Continue holding down the SPEED/SET button and then press either 2, 3, 4, 5, or 6 to enter a corresponding value of two through six for the Ringer Counter.
4. Release the SPEED/SET button, and you'll hear an announcement confirming your choice.

5. To check the Ringer Counter setting, first press the SPEED/SET button, followed by #, then 4.

NOTE: If you want to change the Ringer Counter setting, simply repeat the above steps. Also, the Toll Saver feature may add to the number of rings (see "Using the Toll Saver Counter" on page 33).

ACTIVATING AUTO-ANSWER

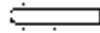

After recording your (Normal or Dialogue) greeting message, and setting the Maximum Record Time and Ringer Counter, you are ready to activate the Auto-Answer function to record messages while you're away from your home.

1. Press the ANSWER SYSTEM button. The ANSWER and PLAY indicators will begin flashing, and you'll hear the current greeting message.

NOTE: During playback of the greeting message, the PLAY indicator will flash slower than the ANSWER.

2. After the greeting message has played, the PLAY indicator will go out, and the ANSWER indicator will switch to a steady state, confirming your choice.
 3. At this point the IS-M20 is set to record messages according to the parameters you have set for type and length of recording.
-

NORMAL RECORDING OF A RECEIVED MESSAGE

1. After two to six rings, the IS-M20 automatically answers the call (refer to *Using the Toll Saver Counter* on page 33). The Power/Call indicator will turn green.
2. Your greeting message is played while the PLAY indicator flashes.

NOTE: If you are screening your call, picking up the Handset at this point will initiate a Tone and Day Stamp and stop the recording. However, the line will not be disconnected, so you can continue taking the call.

3. When the greeting is finished playing, a beep will sound, and the caller's message will be recorded. The REC indicator will start flashing. The caller's response will be played over the Speaker.
4. When the Maximum Recording Time runs out, or the caller hangs up, another beep will sound, and the phone will automatically disconnect the line. The recording ends with the Time and Day Stamp. The REC indicator will turn off and Power/Call indicator will turn red.
5. The ANSWER indicator will periodically flash from one to ten times to indicate you have one to ten recorded messages. When you play back your messages (see page 28), the IS-M20 will announce the number of recorded messages.

NOTE: If you have more than eleven messages, the ANSWER indicator will flash rapidly. The number of messages is limited to the length of the MC-60 microcassette which is 30 minutes per side. If the entire tape is filled with messages, the IS-M20 will automatically exit the Auto-Answer mode.

DIALOGUE RECORDING OF A RECEIVED MESSAGE

Dialogue Recording is the same as Normal Recording except recording begins with start of the greeting message. The IS M20 automatically switches to this mode when it recognizes a Dialogue Greeting Message (see *Recording a Dialogue Greeting Message* on page 24).

When you play back these type of messages, you'll also hear your Dialogue Greeting along with any conversation your caller may have made during the greeting time period.

SCREENING CALLS (WITHOUT AUTO-ANSWER)

You can also screen your calls without Auto-Answer on by listening to the caller's response to your greeting message over the Speaker.

1. Leave the Handset in the Cradle; make sure Auto-Answer is not selected (ANSWER indicator is off).

2. When you hear a call come in (Ringer sounds and Power/Call indicator flashes), press the ANSWER SYSTEM button. Immediately, you will hear your greeting message being sent to the caller.
3. After the beep has sounded and you hear who the caller is, you can either continue listening to the message over the Speaker, or you can pick up the Handset and take the call.

NOTE: In this mode, the IS-M20 does not record the message after the beep. Also, if the caller hangs up during the message or there is more than six seconds of silence, the IS-M20 will automatically disconnect the line.

PLAYING BACK MESSAGES

When you return, check the IS-M20's ANSWER indicator to see if it is flashing. One to ten flashes indicates you have one to ten corresponding messages on your machine. A rapid flashing indicates you have more than ten messages. A steady illumination means no messages have been recorded.

1. To hear your messages, press the ANSWER SYSTEM button. The PLAY indicator will flash, and an announcement will tell you how many recorded messages are on the tape. The IS-M20 will rewind to the beginning and automatically playback the messages, each ending with its own Time and Day Stamp.

NOTE: The IS-M20 counts from zero to 20 messages. If you have more than 20 messages, the IS-M20 will announce "You have 20 messages" as the count.

2. While listening to your messages, if you want to move to a different point in the tape, press FF/TIME (#) for fast forward or REW/TONE (*) for rewind. Press STOP (0) to resume playback.
3. When playback ends, you'll hear three beeps. At this point, you have two options:

- ▼ To hear your messages again, press and hold down the ANSWER SYSTEM button for two seconds. After the message count, the IS M20 rewinds the tape and plays back your messages.
- ▼ To record new messages, press the ANSWER SYSTEM button to automatically rewind the tape to the start for new recordings.

IMPORTANT NOTES:

If you do not press STOP (0) during fast forward or rewind and the tape reaches the beginning (rewind) or end (fast forward), you must press and hold down the ANSWER SYSTEM button for more than two seconds to hear your messages again.

If you do not play back all messages and you press the ANSWER SYSTEM button, the IS-M20 will assume you want to keep the existing messages and will position the tape to start after the last-recorded Time and Day Stamp, as shown in Figure 13.

Taking a call during playback will stop the tape. Press and hold down the ANSWER SYSTEM button for more than two seconds to hear your messages again.

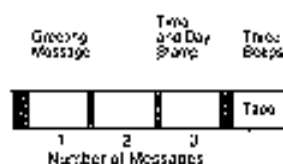
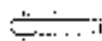

Figure 13. Each message ends with a Time and Day Stamp. Three beeps follow the last recorded message.

ERASING MESSAGES



Perform the following steps to completely erase all messages.

1. Press and hold down 0, and press the ANSWER SYSTEM button.
2. When you release these buttons, the tape will automatically fast forward to the end, and then enter the rewind mode. During this time all messages on the current tape side will be erased.
3. After a few minutes, the tape will stop at the beginning, ready for new recordings.

USING SECRET CALL

In this section, you will learn how to use our exclusive feature, Secret Call, on your IS-M20.

Simply put, callers that know your Secret Call Code are allowed to ring through. At that point, you still have the option of either picking up the Handset or letting Auto-Answer record the message.

NOTE: The caller must use a Tone telephone to enter the Secret Call Code.

All other callers are denied access and will only hear a simulated ring. On your end, only the IS-M20's Power/Call Indicator will flash with each ring.

ENTERING A SECRET CALL CODE



You will need to enter a Secret Code in order to make your IS-M20 accessible to desired callers.

1. Leave the Handset in the Cradle.
2. Hold down the SPEED/SET button, and then press #, followed by 2.
3. Continue holding the SPEED/SET button as you enter a four-digit secret code by pressing appropriate dial keys.
4. Release the SPEED/SET button, and you'll hear an announcement confirming your Secret Call Code.
5. To check the Secret Call Code, first press the SPEED/SET button, followed by #, and then 2.

NOTE: If you want to change the Secret Call Code, just repeat the above steps to overwrite the existing code.

REMOTE FEATURES

In this section, you will learn how to access your IS-M20 Integrated Answering Telephone through a remote telephone keypad.

ENTERING OR DELETING A REMOTE ACCESS CODE

In order to access your IS-M20 from a remote location, you must record a Greeting Message (see *Using the IS-M20 as an Answering Machine* on page 22), as well as enter a Remote Access Code.

NOTE: To insure privacy, enter a Remote Access Code that is different than the one used for the Secret Call Code.

1. Leave the Handset in the Cradle.
2. Hold down the SPEED/SET button, and then press #, followed by 1.
3. Continue holding the SPEED/SET button as you enter a four-digit code via appropriate dial keys.
4. Release the SPEED/SET button, and you'll immediately hear an announcement confirming your Remote Access Code entry.
5. To check the Remote Access Code, first press the SPEED/SET button, followed by #, and then 1.

NOTE: If you want to change the Remote Access Code, just repeat steps 1 through 5 to overwrite the code.

USING THE TOLL SAVER COUNTER

RINGER COUNTER

Setting	Toll Saver
2	4
3	5
4	6
5	7
6	8

Figure 14. Toll Saver adds two rings to the Ringer Counter setting.

PLAYING BACK MESSAGES (AUTO-ANSWER IS ON)

Toll Saver is an automatic feature in the Auto-Answer mode. When there are no recorded messages, the Toll Saver will add two more rings to the Ringer Counter setting, as shown in Figure 14.

Use this feature when calling your IS-M20 from a remote phone. If you hear the IS-M20 keep ringing past the Ringer Counter setting (e.g., 2-6), you will know that no messages have been recorded.

The two extra rings will allow you ample time to hang-up before your phone answers and registers a possible charge.

1. From a remote phone, call your home number and when you hear the Greeting Message, press #. The IS-M20 will stop the greeting. Enter your Remote Access Code via the keypad. Then, you will hear "Please Wait," followed by the number of messages recorded, and then your messages.

[*NOTE: To hear the messages again, press # and enter your Remote Access Code. You will hear "Please Wait," followed by the number of messages recorded, and then your messages.*

2. While listening to your messages, enter any of the following codes to fast forward or rewind a message:

COMMAND	FUNCTION
#	Fast Forward Tape
*	Rewind Tape
0	Resume Playback

[*NOTE: While listening to your messages in the normal Play mode, pressing 0 will stop the tape.*

3. When all messages have been played back, you'll hear three short beeps after the last Time and Day Stamp. If you're finished, hang-up and the IS-M20 will engage Auto-Answer to record new messages from that point on the tape.

ACTIVATING AUTO-ANSWER

1. From a remote phone, call your home number. After ten rings, you will hear repeated beeps. Press #, and then enter the Remote Access Code
2. You will hear the greeting message, and the IS-M20 will be automatically set to record new messages.

IN CASE OF DIFFICULTY

If you experience difficulty operating your IS-M20, check the following list of symptoms and their probable causes and solutions before seeking service.

SYMPTOM	PROBABLE CAUSE	SOLUTION
No dial tone	IS-M20 not connected to phone line	Connect phone cord from IS-M20 to phone line jack (see page 12)
	ac adapter not plugged in	Connect ac adapter (see page 13)
	No ac power	Check fuse box or circuit breaker
Dial tone okay; cannot dial out	DIAL Mode Switch set to wrong service	Slide DIAL Mode Switch to other setting (see page 14)
Phone does not ring when receiving call	RINGER is set to Off position	Slide RINGER Loudness Switch to either Low or High (see page 15)
Cannot hear speaker in "monitor" mode	Speaker volume too low	Slide VOLUME Control to right (from side) to increase loudness (see page 15)

SYMPTOM	PROBABLE CAUSE	SOLUTION
Cannot activate Auto-Answer	Microcassette jammed or not loaded properly	Reload tape (see page 10)
	No Greeting Message	Record Greeting Message (see page 23)
Cannot record Greeting Message	Did not press and hold ANSWER before lifting Handset	Review procedure on recording Greeting Message (see page 23)
Recorded messages are muffled or have drop-outs	Microcassette mechanism needs cleaning or tape needs replacement	Clean mechanism or replace tape (see page 12)
Messages have wrong Time and Day Stamp	Power was out for more than three hours or incorrectly set	Set Time and Date Stamp (see page 15)
Old messages not erased	Stop playback before hearing three beeps after last message	Review playing back of messages (see page 28)
Callers' messages are cut off	Record Time is too short	Increase Record Time (see page 25)
Speed Dial Memories don't work	Power was out for more than three hours or incorrectly set	Reset Speed Dial Memories (see page 19)
Secret Call doesn't work	Secret Call Code not set or caller doesn't know code	Review Secret Call Code (see page 30)