



# Ampli455

## Amplified Big Button Telephone And Answering Machine



English



# CONTENTS

|                                              |           |
|----------------------------------------------|-----------|
| <b>CONTENTS</b>                              | <b>1</b>  |
| <b>INTRODUCTION</b>                          | <b>4</b>  |
| Unpacking the Telephone                      | 5         |
| <b>DESCRIPTION and General Description</b>   | <b>6</b>  |
| Key Description                              | 7         |
| LCD Description                              | 9         |
| Menu Navigation                              | 10        |
| <b>INSTALLATION and Setting Up</b>           | <b>12</b> |
| Wall Mounting                                | 12        |
| <b>SETTINGS</b>                              | <b>13</b> |
| Set Language                                 | 13        |
| Set Contrast                                 | 13        |
| Night Light Function                         | 14        |
| Set Font Size                                | 14        |
| Hour Format Setting                          | 15        |
| Date Format Setting                          | 15        |
| Ringer Setting                               | 16        |
| Incoming Call Notification Setting           | 17        |
| VIP Ringer Setting                           | 17        |
| Keypad Tones Setting                         | 18        |
| Call Waiting                                 | 18        |
| Flash Time Setting                           | 19        |
| Dialling Mode Setting                        | 20        |
| Setting Date and Time                        | 20        |
| Dialling Talking Setting                     | 21        |
| Caller ID Talking Setting                    | 22        |
| Review the Phonebook and Caller ID List      | 22        |
| Voice Prompt                                 | 23        |
| Receiving Volume and Tone Settings           | 23        |
| <b>USING THE TELEPHONE and Making a Call</b> | <b>26</b> |
| Last Number Redial                           | 27        |

# CONTENTS

|                                                        |           |
|--------------------------------------------------------|-----------|
| Dialling a Number from the Redial List                 | 27        |
| Clear the Redial List                                  | 27        |
| Mute Function                                          | 28        |
| Hold Function                                          | 28        |
| Receiving a Call                                       | 28        |
| Hearing Aid Use                                        | 29        |
| Flash Signal                                           | 29        |
| <b>OPTIONAL ACCESSORIES</b>                            | <b>30</b> |
| Shaker                                                 | 30        |
| Headset and Audio Neck Loop Use                        | 30        |
| <b>CALLER ID</b>                                       | <b>31</b> |
| View Caller ID List                                    | 31        |
| Dial a Number from the Caller ID List                  | 31        |
| Add a Number from the Caller ID List to the Phone book | 32        |
| Delete a Number from the Caller ID List                | 32        |
| Delete all Numbers from the Caller ID List             | 33        |
| Caller ID on Call Waiting                              | 33        |
| <b>PHONE BOOK</b>                                      | <b>34</b> |
| Create a Phone Book Entry using the Menu               | 34        |
| Create a Phone Book Entry in Standby Mode              | 34        |
| View Phone Book Entries                                | 36        |
| Dial a Phone Book Entry                                | 36        |
| Modify a Phone Book Entry                              | 37        |
| Delete a Phone Book Entry                              | 38        |
| Voice Announce a Phonebook Entry                       | 38        |
| Record Voice Announce for a Phonebook Entry            | 39        |
| Delete Voice Announce for a Phonebook Entry            | 39        |
| <b>QUICK DIAL</b>                                      | <b>41</b> |
| Create a Quick Dial Number                             | 41        |
| View/Dial a Quick Dial Number                          | 41        |
| Clear a Quick Dial Number                              | 42        |

# CONTENTS

|                                          |           |
|------------------------------------------|-----------|
| <b>ANSWERING MACHINE</b>                 | <b>43</b> |
| Switching the Answering Machine On/Off   | 43        |
| The Outgoing Message                     | 44        |
| Recording an Outgoing Message            | 44        |
| Checking an Outgoing Message             | 45        |
| Restore the Outgoing Message             | 45        |
| Answering Machine Settings               | 46        |
| Listening to Messages                    | 47        |
| Call Screening                           | 48        |
| Incoming Message Voice Slow              | 48        |
| Operating the Answering Machine Remotely | 49        |
| Remote Code                              | 49        |
| Remote Control                           | 50        |
| Remote Control Commands                  | 50        |
| Recording a Memo                         | 50        |
| Out of Memory                            | 51        |
| <b>TROUBLESHOOTING</b>                   | <b>52</b> |
| <b>SAFETY INFORMATION</b>                | <b>53</b> |
| <b>REGULATORY COMPLIANCE</b>             | <b>54</b> |
| <b>GUARANTEE</b>                         | <b>57</b> |

# INTRODUCTION

Congratulations on purchasing your Geemarc Ampli455. This is a multifunction telephone which offers features such as hands free use, caller ID\*, caller announce, dialling talking, a phone book, quick dial and an answering machine. It offers amplification, helpful for those with hearing difficulties. It has a large button, easy to see and use keypad, to help stop any misdialling. This telephone is compatible with hearing aids.

It is important that you read the instructions below in order to use your Geemarc telephone to its full potential. Keep this user guide in a safe place for future reference.

This guide explains how to use the following telephone:

## Ampli455



\*To use the caller display facility, you must subscribe to your network provider's caller display service.

# INTRODUCTION

## Unpacking the Telephone

---

When unpacking the telephone, you should find the following in the box:

- 1 Ampli455 unit
- 1 Ampli455 handset with curly cord
- 1 Telephone line cord
- 1 Mains power adaptor
- 1 User Guide

## SonicAlert

Sonic Alert Warranty Center  
1081 West Innovation Dr.  
Kearney, MO 64060

Sales: 248-577-5400 Fax: 248-577-5433  
Customer Service & Warranty: 1-888-864-2446



# DESCRIPTION

## General Description

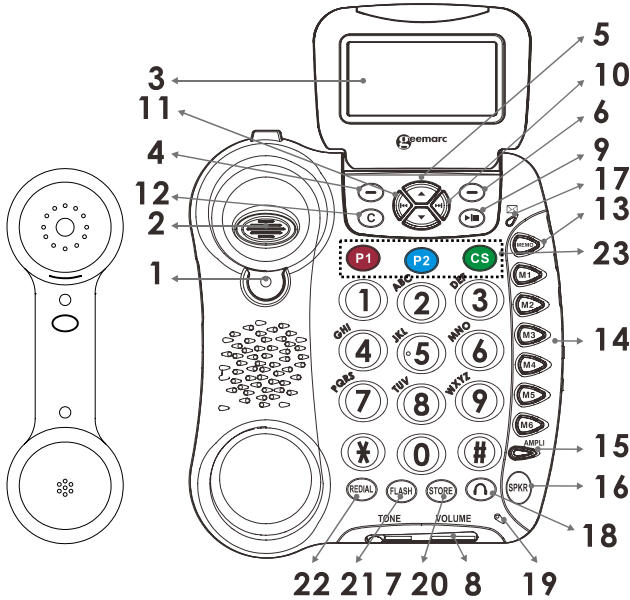

- |                                |                                                                                                     |
|--------------------------------|-----------------------------------------------------------------------------------------------------|
| 1. Handset Knob                | 13. MEMO                                                                                            |
| 2. Hook Switch                 | 14. Speed Dial Key (M1-M6)                                                                          |
| 3. Large LCD Screen            | 15. Additional Amplifier key/indicator                                                              |
| 4. Left Soft Key               | 16. Speaker Key                                                                                     |
| 5. Up/Down Scroll              | 17. Message waiting/new call LED                                                                    |
| 6. Right Soft Key              | 18. Headset Key  |
| 7. Tone reception Adjustment   | 19. Microphone                                                                                      |
| 8. Volume reception Adjustment | 20. Store Key                                                                                       |
| 9. Play/Stop                   | 21. R Key                                                                                           |
| 10. Next                       | 22. Redial Key                                                                                      |
| 11. Previous                   | 23. Emergency Speed Dial (P1, P2, CS)                                                               |
| 12. DEL (C)                    |                                                                                                     |



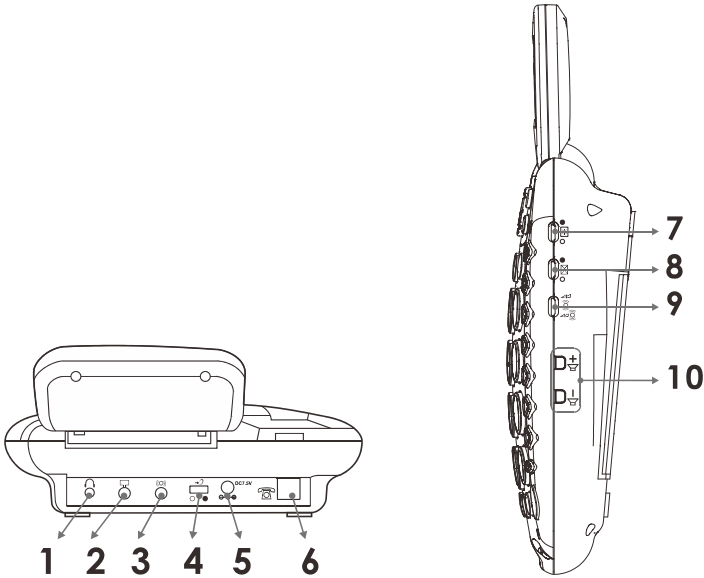

# DESCRIPTION















1. Headset jack
2. Audio neckloop jack
3. Optional Bed Shaker jack
4. Volume Reset Override Switch (ON/OFF)
5. Power jack
6. Phone Line Cord jack
7. Back Light Switch
8. New Call Indicator Switch
9. Shaker/Strobe/Strobe and Shaker Select Mode
10. Volume controls

## Key Description

|                                                                                     |                                                                                |
|-------------------------------------------------------------------------------------|--------------------------------------------------------------------------------|
|  | Make/Answer/End a call.<br>Activates the speakerphone if pressed during a call |
|  | Last number redial<br>Insert a pause when pre-dialing a number                 |

# DESCRIPTION

|                                                                                                       |                                                                                                                                                                                                        |
|-------------------------------------------------------------------------------------------------------|--------------------------------------------------------------------------------------------------------------------------------------------------------------------------------------------------------|
|                      | <p>Scroll through the menu options.<br/>Enter the Caller ID list</p>                                                                                                                                   |
|                      | <p>Soft keys. They perform the functions indicated by the text immediately over it (on the bottom line of the display) which changes depending on context</p>                                          |
| <p><b>AMPLI</b></p>  | <p>Press this button to turn the extra amplification ON or OFF</p>                                                                                                                                     |
|                      | <p>The nine keys are used as one-touch speed dial keys</p>                                                                                                                                             |
|                      | <p>This key is used to store numbers</p>                                                                                                                                                               |
|                      | <p>This button is used to disconnect a call and re-establish dial tone or to switch over to another caller provided you have requested these services i.e. call waiting from your service provider</p> |
|                      | <p>Press to start or stop the Message or Memo playing.</p>                                                                                                                                             |
|                     | <p>Press to play the next message</p>                                                                                                                                                                  |
|                    | <p>Press once to play the current message.<br/>Press twice to play the previous message</p>                                                                                                            |
|                    | <p>When playing a message press this key to delete the current message.</p>                                                                                                                            |
|                    | <p>Press and hold this key to record a memo</p>                                                                                                                                                        |
|                    | <p>Use them to adjust the volume of ringer, dialing talking, Caller ID announcing and speakerphone</p>                                                                                                 |

# DESCRIPTION

## LCD Description

In standby mode, the large LCD display will show as below

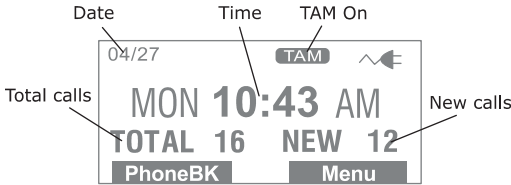

If you forget to connect the phone line cord, **No line** will show on the screen

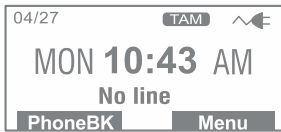

When you press the **Menu** soft key, the main menu will be displayed. Use **▲** or **▼** to scroll through the menu until you find the desired option. Press the **select** soft key to confirm.

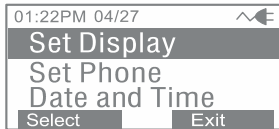

On receiving an incoming call, the caller's phone number and/or name will be displayed (providing you have subscribed to the Caller ID service with your network provider).



The screen below shows the total calls and new calls needing reviewing. In this example you have 16 calls in total, which includes 12 new calls.

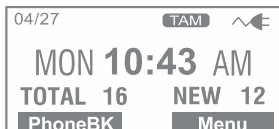

# DESCRIPTION

The screen below shows that you have 2 new answer machine messages.

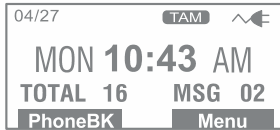

If you subscribe to a Caller ID service -If the caller has exercised the option to prevent their name and number from being sent, **Private** will be shown on the display.

If you subscribe to a Caller ID service – **Out of Area** will display when someone calls from an area where the telephone company is not offering the caller identification services or is not yet providing number delivery to your area.

## Menu Navigation

---

To access any menu function you must take the following steps:

- 1) Press the **Menu** soft key, the main menu will be displayed.
- 2) Use ▲ or ▼ to scroll through the menu until you find the desired option.
- 3) Press the **Select** soft key to confirm.



To exit any menu you must take the following step:

- 1) Press the **back** or the **exit** soft key, the phone will return to the previous screen.

## Menu Map

|                    |              |
|--------------------|--------------|
| <b>Set Display</b> |              |
|                    | Set Language |
|                    | Set Contrast |
|                    | Dim:X---x    |
|                    | Hour Format  |
|                    | Date Format  |
| <b>Set Phone</b>   |              |

# DESCRIPTION

|                      |                  |
|----------------------|------------------|
|                      | Set Ring         |
|                      | Call Waiting     |
|                      | Set Flash        |
|                      | Dialling Mode    |
| <b>Date and Time</b> |                  |
| <b>Set Talk</b>      |                  |
|                      | Dialling Talking |
|                      | CID Talking      |
|                      | Review Talking   |
|                      | Voice Prompt     |
| <b>TAM Setup</b>     |                  |
|                      | TAM ON/OFF       |
|                      | Outgoing Msg     |
|                      | Ring Number      |
|                      | Security ID      |
|                      | ICM Voice Slow   |

# INSTALLATION

## Setting Up

---

Connect one end of the curly cord to the handset. The other end of the curly cord plugs into the jack on the left hand side of the Ampli455 unit. Place the handset on the cradle.

Connect the line cord to the socket located at rear of telephone then connect the plug into the wall socket \*\*.

For the LCD display, backlight and other special features you must insert the power adapter. Connect the power adaptor to the jack located at the rear of the telephone then plug the other end into a 13amp wall socket (\*). Please choose a socket near your telephone to enable you to unplug the mains power quickly in case of a problem.

(\*) Classified "hazardous voltage" according to EN60950 standard

(\*\*) Classified TNV-3 according to EN60950 standard.

## Wall Mounting

---

Turn the handset hanger clockwise and reverse its position (rotate it 180 degrees - see diagram 1). This will keep the handset from falling out of the cradle when it is mounted on the wall.

Knock two self-tapping screws (not supplied) into a wall at a distance of 80 mm from each other and placed in a vertical line.

Place the phone onto the screw-heads and slide down to secure (see diagram 2).

# SETTINGS

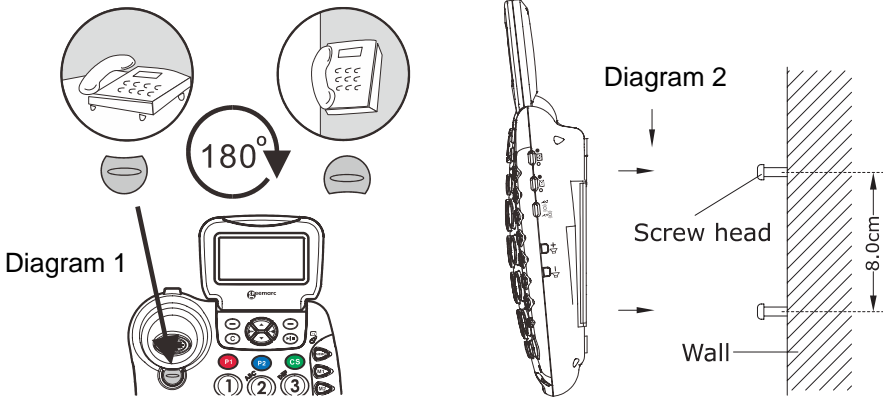

## Set Language

Press **'MENU'** soft key

Press **'SELECT'** soft key to access **'SET DISPLAY'**

Press **'SELECT'** soft key to access **'LANGUAGE'**

Use ▲ and ▼ to select one of the 4 languages available (English, Francais, Espanol, Deutsch)

Press **'SELECT'** soft key to confirm

## Set Contrast

Your screen has a backlight which automatically switches off after 15 seconds of inactivity. The contrast of the backlight against the text can be increased or decreased.

Press **'MENU'** soft key

Press **'SELECT'** soft key to access **'SET**

# SETTINGS

DISPLAY'

Use ▲ and ▼ to select 'SET CONTRAST'



Press 'SELECT' soft key

Use ▲ and ▼ to select one of the 8 contrast levels available

Press 'SELECT' soft key to confirm

## Night Light Function

---

If you wish to use the LCD back light as a night light, switch the back light switch  to . In doing so the back light will be switched on constantly.

## Set Font size

---

The text can be displayed on the LCD screen in either a large font or a small font.

Press 'MENU' soft key

Press 'SELECT' soft key to access 'SET DISPLAY'

Use ▲ and ▼ to select 'DIM:X-→x'

Press 'SELECT' soft key

Use ▲ and ▼ to select either 'ON' (large) or 'OFF' (small)

Press 'SELECT' soft key to confirm



# SETTINGS

**Note:** If large font is 'ON', when you pre-dial a number – if the telephone number exceeds 8 digits, the font will be switched to the smaller size automatically.

## Hour Format Setting

---

Press 'MENU' soft key

Press 'SELECT' soft key to access 'SET  
DISPLAY'

Use ▲ and ▼ to select 'HOUR FORMAT'

Press 'SELECT' soft key

Use ▲ and ▼ to select either '12 HOUR CLOCK' or  
'24 HOUR CLOCK'

Press 'SELECT' soft key to confirm

**Note:** If 12 hour clock is selected, AM or PM will be displayed on the right hand side of the time in standby mode.

## Date Format Setting

---

Press 'MENU' soft key

Press 'SELECT' soft key to access 'SET DISPLAY'

Use ▲ and ▼ to select 'DATE FORMAT'

Press 'SELECT' soft key

# SETTINGS

Use ▲ and ▼ to select either '**MM/DD**' or '**DD/MM**'

Press '**SELECT**' soft key to confirm

## Ringer Setting

You can select your own ring tone and adjust both the day volume and night volume. You can also adjust the volume to off in order to turn the ringer off.

Press '**MENU**' soft key

Use ▲ and ▼ to select '**SET PHONE**'

Press '**SELECT**' soft key

Use ▲ and ▼ to select '**SET RING**', press '**SELECT**'

'**DAY VOLUME**' will be displayed on the LCD display  
(6am-10pm)

Press '**CHANGE**' soft key to select the desired volume for the ringer during the day. Each time you press the '**CHANGE**' soft key either '**LOW**', '**MEDIUM**', '**HIGH**' or '**OFF**' will be displayed and the phone will ring at the selected volume level

Use ▼ to select '**NIGHT VOLUME**' (10pm to 6am)

Use the volume setting method described above to set the desired volume for the ringer during the night

Use ▼ to select '**RING TONE**'

Press '**CHANGE**' soft key to select the desired ring tone. Each time you press the '**CHANGE**' soft key, the phone

# SETTINGS

rings with the selected ring tone.

Press '**SAVE**' soft key to confirm

You can also adjust the ringer volume whilst in standby. Simply use the volume controls VOL+ and VOL- found on the right hand side of the telephone. The display will show the current level. For example: '**RINGER LOW**'.

## Incoming Call Notification Setting

---

There is a Shaker/Strobe/Shaker and Strobe select switch on the right hand side of the telephone. This allows you to choose the way you wish to be notified of an incoming call. There is the adjustable ringer, a bright strobe that flashes on receiving a call and finally a bed shaker. You can choose one of these options or any combination of the three. If you have purchased the optional bed shaker, simply plug into the shaker jack and place it between your mattress and box spring.

## VIP Ringer Setting

---

Any contact saved in the phone book will have the VIP ringer tone associated with their details automatically.

Press '**MENU**' soft key

Use ▲ and ▼ to select '**SET PHONE**'

Press '**SELECT**' soft key

Press '**SELECT**' soft key to access '**SET RING**'

Use ▲ and ▼ to select '**VIP TONE**'

Press '**CHANGE**' soft key to select the desired ring tone. Each time you press the '**CHANGE**' soft key, the

# SETTINGS

phone rings with the selected ring tone.

Press **'SAVE'** soft key to confirm

## Keypad Tones Setting

---

Press **'MENU'** soft key

Use ▲ and ▼ to select **'SET PHONE'**

Press **'SELECT'** soft key

Press **'SELECT'** soft key to access **'SET RING'**

Use ▲ and ▼ to select **'KEYPAD TONES'**

Press **'CHANGE'** soft key to set the keypad tones.  
You can choose either **'ON'**, **'OFF'** or **'Link to Ringer'**

Press **'SAVE'** soft key to confirm

**Note:** Link to ringer means the keypad tones will be heard at the same volume as the ringer volume. Any changes made to the ringer volume will automatically update the keypad tone volume.

## Call Waiting

---

If you subscribe to Call Waiting service from your service provider, you should activate the Call Waiting function on the telephone. The telephone will display the name (provided the name and number are stored in the phonebook) and number of a second caller while you are having a conversation.

# SETTINGS

Press **'MENU'** soft key

Use ▲ and ▼ to select **'SET PHONE'**

Press **'SELECT'** soft key

Use ▲ and ▼ to select **'CALL WAITING'**

Press **'SELECT'** soft key

Use ▲ and ▼ to select **'ON'** or **'OFF'** to activate the call waiting function

Press **'SELECT'** soft key to confirm

## Flash Time Setting

---

You can adjust the flash time setting. There are four options available. Your telephone works with a flash time for United Kingdom (R=100ms).

Press **'MENU'** soft key

Use ▲ and ▼ to select **'SET PHONE'**

Press **'SELECT'** soft key

Use ▲ and ▼ to select **'SET FLASH'**

Press **'SELECT'** soft key

Use ▲ and ▼ to select either **'100ms'**, **'110ms'**, **'300ms'** or **'600ms'**

Press **'SELECT'** soft key to confirm

# SETTINGS

## Dialling Mode Setting

---

In the UK, all telephone exchanges now use Tone dialing. If your telephone does not dial out, it is probably being used from an older private switch-board (PBX). In this case, the Tone/Pulse setting must be changed to Pulse.

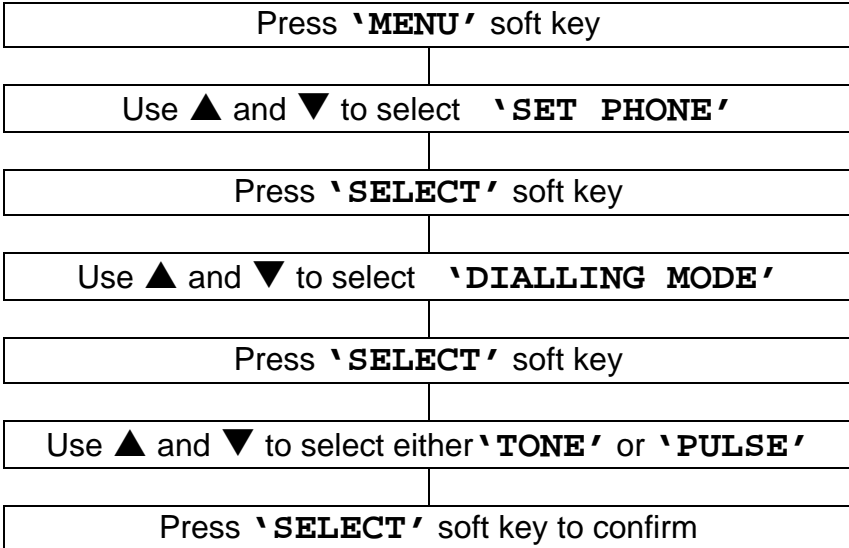

## Setting Date and Time

---

In standby mode, the telephone displays the current date and time. You need to set the date and time so that when you receive calls they will appear in the call list with the correct date and time. If you subscribe to a Caller ID service, the time and date will be set automatically when you receive your first call.

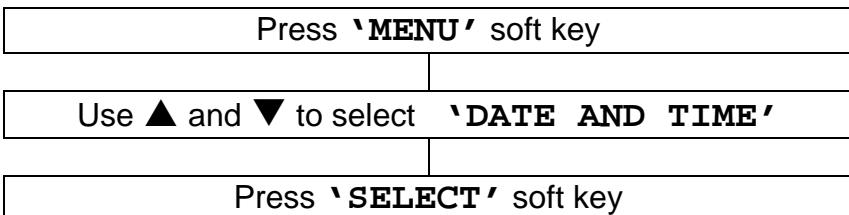

# SETTINGS

Enter the correct time using the numeric keypad

Press **'SAVE'** soft key

Enter the correct date using the numeric keypad

Press **'SAVE'** soft key

Use ▲ and ▼ to select the correct weekday e.g. MON,  
TUE WED, etc

Press **'SAVE'** soft key

## Dialling Talking Setting

---

This feature allows you to check the number you have entered in standby mode without looking at the display i.e. the number is announced when pressed.

Press **'MENU'** soft key

Use ▲ and ▼ to select **'SET TALK'**

Press **'SELECT'** soft key

Press **'SELECT'** soft key to access **'DIALLING TALKING'**

Use ▲ and ▼ to select either **'ON'** or **'OFF'** to activate/deactivate the dialling talking function

Press **'SELECT'** soft key to confirm

# SETTINGS

## Caller ID Talking Setting

---

This feature allows you to check the Caller ID number on receiving a new call without looking at the display i.e. the telephone number is announced (provided the number has not been blocked by the caller). If you have stored the incoming telephone number in the phone book and recorded the corresponding name, the name will be announced.

Press **'MENU'** soft key

Use ▲ and ▼ to select **'SET TALK'**

Press **'SELECT'** soft key

Use ▲ and ▼ to select **'CID TALKING'**

Use ▲ and ▼ to select either **'ON'** or **'OFF'** to activate/deactivate the Caller ID talking function

Press **'SELECT'** soft key to confirm

## Review the Phonebook and Caller ID List

---

The telephone can announce numbers stored in the phonebook and the Caller ID list (except Private and Out of Area calls). If a name is stored with a telephone number, the name will be announced.

Press **'MENU'** soft key

Use ▲ and ▼ to select **'SET TALK'**

Press **'SELECT'** soft key



# SETTINGS

Use ▲ and ▼ to select **'REVIEW TALKING'**

Use ▲ and ▼ to select either **'ON'** or **'OFF'** to activate/deactivate the review talking function

Press **'SELECT'** soft key to confirm

## Voice Prompt

---

You can select the language in which to play the voice prompt.

Press **'MENU'** soft key

Use ▲ and ▼ to select **'SET TALK'**

Press **'SELECT'** soft key

Use ▲ and ▼ to select **'VOICE PROMPT'**

Use ▲ and ▼ to select the required language (English, Deutsch or Francais)

Press **'SELECT'** soft key to confirm

## Receiving Volume and Tone Settings

---

You can alter the receiving volume and tone during a conversation according to your hearing requirements.

Use the Volume slide control found at the front of the telephone base to adjust the level. The volume adjustment available is 0-15dB.

# SETTINGS

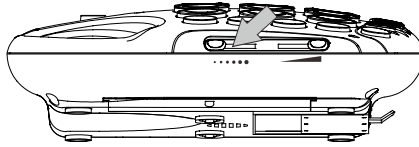

The  button on the telephone base provides additional amplification of 15dB i.e the volume adjustment available is 15-30 dB. When the amplify function is activated, the Amplify LED is lit.





## Setting a default for Amplification.

The Amplify **ON /OFF** () located at the rear allows the amplification facility to be switched ON or OFF as a default each time you use the telephone.

### **AMPLIFY ON/OFF Switch at ON Position** ()

The additional amplification and tone controls are automatically activated each time you use the telephone. The amplify LED light will be lit when you use the telephone.



Pressing the Amplify key () during a call will turn off the additional amplification and tone controls. However, you can still adjust the handset receive volume with the Volume slide bar.

Irrespective of how many times you press the Amplify key () throughout a call, the next time you pick up the handset to make a new call, these functions will be activated once again.

### **AMPLIFY ON/OFF Switch at OFF Position** ()

The additional amplification and tone controls are turned off each time you use the telephone. The Amplify LED will be off whenever you use the telephone.

# SETTINGS

Pressing the Amplify key (  ) once during a call will enable tone control and additional amplification. The LED light will turn on to reflect this change. If you press the Amplify key (  ) once more, the additional amplification and tone control features will be turned off once again. The LED light will turn off to reflect this change.

Irrespective of how many times you press the Amplify key (  ) throughout a call, the next time you pick up the handset, these functions will be turned off once again.

## Tone Receiving Adjustment

If the receiver volume has been amplified, the tone control can also be adjusted. You can adjust and increase the low frequency or high frequency sounds with the tone slide control on the top of the unit.



**Note:** The tone adjustment function will not be affective when the amplify feature is not being used

# USING THE TELEPHONE

## Making a Call



---

Pick up the handset.

When you hear the dialling tone, dial the number on the keypad.

To end the call simply replace the handset in the cradle

### Making a Call – Hands Free

Press the SPKR button to get a dialling tone then dial the telephone number on the keypad. The  icon appears on the LCD. To end the call, simply press SPKR again. The  icon will disappear.

To activate the Hands Free function during the call, press the SPKR button and replace the handset on the cradle at the same time.

To deactivate the Hands Free function during a call, lift the handset.

**Note:** When in hands free mode, only one person may talk at a time. The switch-over between speaker and microphone is automatic. This is dependent on the sound level of the incoming call and the microphone respectively. It is therefore essential that there are no loud noises, e.g. music, in the immediate vicinity of the telephone, as this will disrupt the hands free function.

### Speakerphone Volume Setting

In hands free mode you can adjust the speaker volume by using the volume controls VOL+ or VOL- located on the right side of the phone.

# USING THE TELEPHONE

## Pre-Dialling a Telephone Number

You can enter the desired phone number in standby mode, which allows you to make corrections before dialling. Follow these steps:

Enter a telephone number (up to 32 digits). Check it. If you make a mistake while entering a number, press the '**CLEAR**' soft key to edit it.

When the number appears correctly, lift the handset or press the SPKR button.

## Last Number Redial

---

Lift the handset or press SPKR for hands free use

Press REDIAL to redial the last number dialled.

## Dialling a Number from the Redial List

---

Press REDIAL whilst in standby mode

Use ▲ and ▼ to scroll through the redial list to find the desired number

Lift the handset or press SPKR for hands free use

## Clear the Redial List

---

Press REDIAL whilst in standby mode

Press and hold 0 key . The LCD will display '**EMPTY LIST**' to indicate that all the entries in the redial list have been deleted

# USING THE TELEPHONE

## Mute Function

---

If you wish, you can speak privately to someone else in the room without your caller overhearing. You will still be able to hear the caller but they cannot hear you during the mute operation.

To switch on the mute mode during a call press the **'MUTE'** soft key (**'MUTE'** will be displayed on the LCD). Your caller will not be able to hear you anymore. Press **'UNMUTE'** soft key to resume the conversation with your caller (**'MUTE'** will no longer be displayed on the LCD).

## Hold Function

---

You can put a call on hold. Do this by simply pressing the **'HOLD'** soft key during a call. The LCD will display **'CALL ON HOLD'**. If you hang up now, the call will not be disconnected.

To continue the conversation, simply pick up the handset or press the **'UNHOLD'** soft key.

## Receiving a Call

---

When an incoming call is received, the telephone rings and the incoming call indicator lights up. If you have a voice message, NEW VOICE MAIL will be shown on the LCD. To delete the voice message, press ▲ in standby then press and hold **4**.

Lift the handset and speak

To end the call simply replace the handset in the cradle

## Receiving a call – Hands Free

Press **SPKR** to speak hands free

To end the call press **SPKR**

# USING THE TELEPHONE

## **Hearing Aid Use**

---

This telephone is hearing aid compatible. Select the T mode on your hearing aid to enable this feature.

## **Flash Signal**

---

The **R** button can be used with special services such as Call Waiting (if provided by your service provider) or transferring external calls to another extension within a private switchboard.

# OPTIONAL ACCESSORIES

## Shaker

---



At the rear of the telephone, there is a 3.5mm shaker jack . You can connect an optional shaker device. When you are receiving an incoming call, the shaker will vibrate. (See Incoming Call Notification Settings)

## Headset and Audio Neck Loop Use

---

Your phone is equipped with both an Audio and Headset jack at the rear of the telephone. Both the two jacks are amplified, allowing you to adjust both the tone and volume.

The Audio Neckloop jack allows you to listen through your Neckloop whilst speaking into the handset or the speakerphone

The Headset jack allows you to listen and speak through your hands free headset. Connect the headset at the rear side of the base in the 2.5mm jack . Press  to get a dial tone



# CALLER ID

The features described in this section are only available if you subscribe to a Caller ID service from your network provider. Caller ID means you can see who is calling on your handset display (provided the number is not withheld, unavailable or is an international call).

The display shows '**PRIVATE**' for a withheld number.

The display shows '**Out of Area**' when someone calls from an area where the telephone company is not offering caller identification services or is not yet providing number delivery to your area.

Whether you take a call or not, the caller's telephone number/name together with the date and time of the call are stored in the Caller ID list. This book stores the last 30 incoming calls of up to 15 digits.

The New Call LED will flash to notify you of a new call. If you do not want the New Call LED to be lit to notify you of a new call,

switch the new call indicator switch  (found on the right side of the unit) to Off.

## View Caller ID List

---

Use ▲ and ▼ to scroll through the Caller ID list. The numbers will be listed in the order they were received. Scrolling through this list in order to review any new calls sets the New Call count to zero and the New Call LED will be switched off

## Dial a Number from the Caller ID List

---

Use ▲ and ▼ to scroll through the Caller ID list until you find the desired number

Pick up the handset or press the SPKR key, the number is automatically dialed.

# CALLER ID

## Add a Number from the Caller ID List to the Phone Book

---

Use ▲ and ▼ to scroll through the Caller ID list until you find the number you wish to add to the phone book

Press **'OPTIONS'** soft key

Use ▲ and ▼ to select **'STORE'**

**'NAME: '** will be displayed

Enter the name you wish using the numeric keypad

Use ▼ if you want change the number

Modify the phone number if it is not correct with the function **'CLEAR'**

Press **'SAVE'** soft key to confirm

**'RECORD VOICE: '** will be displayed

Select **'YES'** to confirm or **'NO'** to cancel. If you confirm, you can record the name of the phonebook entry (up to 6 seconds). You can also press **'End'** to confirm and end the recording. Your recording will play back for you immediately

## Delete a Number from the Caller ID List

---

Use ▲ and ▼ to scroll through the Caller ID list until you find the number you wish to delete from the Caller ID list

# PHONE BOOK

Press 'OPTIONS' soft key

Use ▲ and ▼ to select 'ERASE'

## Delete All Numbers from the Caller ID List

---

Use ▲ and ▼ to enter the Caller ID list

Press 'OPTIONS' soft key

Use ▲ and ▼ to select 'ERASE ALL'

'ERASE ALL?' will be displayed

Select 'YES' to confirm or 'NO' to cancel

By deleting all the numbers in the Caller ID list, the Total Call count will be set to zero

## Caller ID on Call Waiting

---

When you are using the telephone, if you have subscribed to Call Waiting with your service provider, the name and number of a second caller will be displayed.

Press the **R** key and '2' to answer the second caller.

When you have finished with the second caller, press **R** and '2' again to resume conversation with the original caller.

Telephone numbers can be stored in the phone book. It allows you to store frequently used numbers so that you can easily make a call without having to remember or enter the telephone number

The phone book can contain 39 entries. Each phone number can contain up to 24 digits.

# PHONE BOOK

## Create a Phone Book Entry using the Menu

---

Press '**PHONEBK**' soft key to enter the phone book

Press '**SELECT**' soft key to choose '**ADD NEW NAME**'

'**NAME:**' will be displayed

Enter the name you wish using the numeric keypad

Press '**SAVE**' soft key to confirm

'**NUMBER:**' will be displayed

Enter the number you wish using the numeric keypad (up to 24 digits)

Press '**SAVE**' soft key to confirm

'**RECORD VOICE:**' will be displayed

Select '**YES**' to confirm or '**NO**' to cancel. If you confirm, you can record the name of the phonebook entry (up to 6 seconds). You can also press '**End**' to confirm and end the recording. Your recording will play back for you immediately

Repeat if you want to add more entries to the phone book

## Create a Phone Book Entry in Standby Mode

---

Enter a telephone number whilst in standby

# PHONE BOOK

Press **'STORE'** soft key

**'NAME: '** will be displayed

Enter the name you wish using the numeric keypad

Press **'SAVE'** soft key to confirm

Use ▼ if you want change the number

Modify the phone number if it is not correct with the function **'CLEAR'**

Press **'SAVE'** soft key to confirm

**'RECORD VOICE: '** will be displayed

Select **'YES'** to confirm or **'NO'** to cancel. If you confirm, you can record the name of the phonebook entry (up to 6 seconds). You can also press **'End'** to confirm and end the recording. Your recording will play back for you immediately

Repeat if you want to add more entries to the phone book

**Note:** If you make a mistake while entering a name or number, press **'CLEAR'** soft key to clear the last character/digit and then enter the correct character/digit. If a voice prompt is recorded with a phonebook entry, an icon will be displayed alongside the name.

## Insert Pause

Inserting a pause provides a delay of 3 seconds. This is necessary with some telephone systems.

# PHONE BOOK

To insert a dialling pause between numbers when storing a number, press **REDIAL** until **'P'** appears in the LCD display

## Character Map

| Key | Characters<br>in order |    |    |    |   |
|-----|------------------------|----|----|----|---|
| 0   | 0                      |    |    |    | . |
| 1   | Space                  |    | *  | ,  | 1 |
| 2   | Aa                     | Bb | Cc | (  | 2 |
| 3   | Dd                     | Ee | Ff | )  | 3 |
| 4   | Gg                     | Hh | li | #  | 4 |
| 5   | Jj                     | Kk | Ll | /  | 5 |
| 6   | Mm                     | Nn | Oo | '  | 6 |
| 7   | Pp                     | Qq | Rr | Ss | 7 |
| 8   | Tt                     | Uu | Vv | ?  | 8 |
| 9   | Ww                     | Xx | Yy | Zz | 9 |

When entering letters, you can shift between upper and lower case by pressing \* key. If you need to enter the same letter twice or another letter with the same key, wait a few seconds and the cursor will move automatically to the next space.

## View Phone Book Entries

---

Press **'PHONEBK'** soft key to enter the phone book

Use **▲** and **▼** to scroll through the phone book until you find the contact you wish to view. If the Review Talking feature is activated, the number (or name-if recorded) of the highlighted entry will be announced

Press **'VIEW'** soft key to view details of that phone book entry

## Dial a Phone Book Entry

---

Press **'PHONEBK'** soft key to enter the phone book

# PHONE BOOK

Use ▲ and ▼ to scroll through the phone book until you find the contact you wish to dial

Pick up the handset or press the SPKR key, the number is automatically dialled

## Modify a Phone Book Entry

---

Press **'PHONEBK'** soft key to enter the phone book

Use ▲ and ▼ to scroll through the phone book until you find the contact you wish to edit

Press **'VIEW'** soft key to view details of that phone book entry

Press **'OPTIONS'** soft key

Use ▲ and ▼ to select **'EDIT'**

The cursor will start to flash on the right hand side of the name. Modify name using **'CLEAR'** soft key to clear the previous characters and then enter the correct character(s)

Press ▼ to edit the telephone number

The cursor will start to flash on the right hand side of the number. Modify number using **'CLEAR'** soft key to clear the previous digits and then enter the correct digit(s). Press **'SAVE'** soft key to confirm

# PHONE BOOK

## Delete a Phone Book Entry

---

Press **'PHONEBK'** soft key to enter the phone book

Use ▲ and ▼ to scroll through the phone book until you find the contact you wish to edit

Press **'VIEW'** soft key to view details of that phone book entry

Press **'OPTIONS'** soft key to view details of that phone book entry

Use ▲ and ▼ to select **'ERASE'** and press **'SELECT'**

## Voice Announce a Phonebook Entry

---

Press **'PHONEBK'** soft key to enter the phone book

Use ▲ and ▼ to scroll through the phone book until you find the contact you wish to edit

Press **'VIEW'** soft key to view details of that phone book entry

Press **'OPTIONS'** soft key to view details of that phone book entry

Press **'PLAY VOICE'** soft key and press **'SELECT'**. The voice prompt for this entry will be announced. The name will be announced if you have stored a name. However, if no name has been stored, only the telephone number will be announced



# PHONE BOOK

## Record Voice Announce for a Phonebook Entry

---

Press **'PHONEBK'** soft key to enter the phone book

Use ▲ and ▼ to scroll through the phone book until you find the contact you wish to edit

Press **'VIEW'** soft key to view details of that phone book entry

Press **'OPTIONS'** soft key

Use ▲ and ▼ to select **'RECORD VOICE'**

Press **'SELECT'** soft key

Select **'YES'** to confirm or **'NO'** to cancel. If you confirm, you can record the name of the phonebook entry (up to 6 seconds). You can also press **'End'** to confirm and end the recording. Your recording will play back for you immediately

## Delete Voice Announce for a Phonebook Entry

---

Press **'PHONEBK'** soft key to enter the phone book

Use ▲ and ▼ to scroll through the phone book until you find the contact you wish to edit

Press **'VIEW'** soft key to view details of that phone

# PHONE BOOK

book entry

Press '**OPTIONS**' soft key

Use ▲ and ▼ to select '**ERASE VOICE**' and press  
'**SELECT**'

# QUICK DIAL

This telephone has 9 quick dial memory buttons. Six of these buttons are speed dials and the other three are emergency dials. The Emergency buttons are an ideal location to store the doctor or a close friend's number in case of a problem. Once a number has been stored in a memory location, you only need to press one button to make the call.

## Create a Quick Dial Number

---

Enter the telephone number to be stored (maximum of 32 digits). You can edit the number using the **'CLEAR'** soft key

Press **STORE**. The LCD display will show **'→?'**

Select the quick dial location to store the telephone number by pressing the corresponding button. **'SAVED'** will be displayed

## View/Dial a Quick Dial Number

---

In standby mode, press the required quick dial location. The telephone number will be displayed

Lift the handset or press **SPKR** to dial the quick dial telephone number

**Note:** You can also press and hold one of the speed dial numbers/emergency numbers for about 1 second to automatically turn on the speakerphone and dial the required number.

# QUICK DIAL

## Clear a Quick Dial Number

---

Press STORE. The LCD display will show `→`

Select the quick dial location to be cleared. `SAVED` will be displayed. The location will be cleared of the number. Alternatively, store a new number – this will automatically erase the previous telephone number

# ANSWERING MACHINE

## Switching the Answering Machine On/Off

---

The answering machine can be switched on and off as follows:

Press **'MENU'** soft key

Use ▲ and ▼ to select **'TAM SETUP'**

Press **'SELECT'** soft key

Press **'SELECT'** soft key to select **'TAM ON/OFF'**

Use ▲ and ▼ to select either **'ON'** or **'OFF'** to activate/deactivate the answering machine

Press **'SAVE'** soft key to confirm

When switched to ON position, incoming calls will be answered by the answering machine after a certain number of rings (see Answering Machine Settings). When the answering machine answers an incoming call, the caller will hear your outgoing message. After a short beep they can then leave a message.

If the Answering Machine is OFF, it will answer a call after 10 rings. This is to allow some features to be accessed remotely.

Your Ampli455 answering machine can be operated from either:

- the telephone unit
- remotely from any external telephone.

# ANSWERING MACHINE

## Outgoing Message

---

Before you use the answering machine you should record an outgoing message. The outgoing message is your message to an incoming caller and may be up to 2 minutes in length.

The default OGM is "Please leave your message after the tone". If you prefer, you can record your own OGM.

## Recording an Outgoing Message

---

Press **'MENU'** soft key

Use ▲ and ▼ to select **'TAM SETUP'**

Press **'SELECT'** soft key

Use ▲ and ▼ to select **'OUTGOING MSG'**

Press **'SELECT'** soft key

Use ▲ and ▼ to select **'RECORD OGM'**

Press **'SELECT'** soft key

**'RECORD OGM?'** will be displayed

Select **'YES'** to confirm or **'NO'** to cancel

On hearing the tone, record your personal OGM. When you have finished speaking press the **'END'** soft key. If you speak for longer than 2 minutes, recording will stop automatically. The new OGM will be played after recording

# ANSWERING MACHINE

## Checking the Outgoing Message

---

Press **'MENU'** soft key

Use ▲ and ▼ to select **'TAM SETUP'**

Press **'SELECT'** soft key

Use ▲ and ▼ to select **'OUTGOING MSG'**

Press **'SELECT'** soft key

Press **'SELECT'** soft key to select **'PLAY OGM'**

The current OGM will be played. During the process the display will show **'PLAYING OGM'**. You can press **'EXIT'** soft key to stop and exit or press **'REPLAY'** soft key to play it again.

## Restore the Outgoing Message

---

You can delete your personal recorded OGM and restore the factory default OGM.

Press **'MENU'** soft key

Use ▲ and ▼ to select **'TAM SETUP'**

Press **'SELECT'** soft key

Use ▲ and ▼ to select **'OUTGOING MSG'**

# ANSWERING MACHINE

Press **'SELECT'** soft key

**STAGE A** Use ▲ and ▼ to select **'ERASE MSG'**

Press **'SELECT'** soft key

**'ERASE RECORDED OGM?'** will be displayed

Select **'YES'** to confirm or **'NO'** to cancel

Alternatively, at **STAGE A** you can select the following so as you can toggle between the Default Outgoing Message and the Recorded Outgoing Message

Use ▲ and ▼ to select **'CHANGE MSG'**

Press **'SELECT'** soft key

Use ▲ and ▼ to either **'DEFAULT OGM'** or **'RECORDED OGM'**

## Answering Machine Settings

---

You can select the number of rings before the answering machine is activated and responds to an incoming call. You can choose from the following:

- 3 = calls are answered after three rings
- 4 = calls are answered after four rings
- 5 = calls are answered after five rings
- 6 = calls are answered after six rings
- TS (TOLL SAVER) = activates the toll saver function

In Toll Saver mode incoming calls are answered after five rings until the first new message has been recorded. Once a message has been recorded the answering machine will answer after three



# ANSWERING MACHINE

rings. This is useful when trying to remotely access the answering machine. If the answering machine has not answered at the fourth ring, no messages have been recorded and you can hang up before you are charged for the call. If the machine answers after three rings, new messages have been recorded.

Press **'MENU'** soft key

Use ▲ and ▼ to select **'TAM SETUP'**

Press **'SELECT'** soft key

Use ▲ and ▼ to select **'RING NUMBER'**

Press **'SELECT'** soft key



Use ▲ and ▼ to select either **'3 RINGS'**, **'4 RINGS'**, **'5 RINGS'**, **'6 RINGS'** or **'TOLL SAVER'**

Press **'SAVE'** soft key

## Listening to Messages

---

If you have a new message the display will show how many new messages have been received and new message LED will be lit.

To play the messages, press the  key. To play the messages through the speaker, press  whilst on hook. To play the messages through the receiver, press  after lifting the handset. The telephone will announce, "You have N new messages" or "You have N old messages". The messages will be played one by one. During playback, you can do the following:

# ANSWERING MACHINE

Press **C** to delete the current message

Press  once to re-play the current message

Press  twice to re-play the previous message

Press  to play the next message

Press  or '**EXIT**' soft key to stop the playing and exit

To adjust the playback volume use VOL+ or VOL- on the right side of the telephone. You can also use the amplify function

 AMPLI whilst using the answering machine.

When playback is finished the machine will return to standby mode. All incoming messages are saved (unless you have erased any during playback, see above), new messages will then be recorded after the old ones.

## Call Screening

---

Incoming messages can be heard through the Speakerphone as they are received. If there is no sound, adjust the volume using the control on the right hand side of the telephone. If you want to speak to the caller, lift the handset.

## Incoming Message Voice Slow

---

If you are struggling to hear or understand the message left by a caller, you can play it back in a slow mode.

Press '**MENU**' soft key

Use ▲ and ▼ to select '**TAM SETUP**'

Press '**SELECT**' soft key

# ANSWERING MACHINE

Use ▲ and ▼ to select **'ICM VOICE SLOW'**

Press **'SELECT'** soft key

Use ▲ and ▼ to select either **'ON'**, or **'OFF'**

Press **'SAVE'** soft key

## Operating the Answering Machine Remotely

---

This answering machine can be accessed remotely using the keys of an ordinary tone dialling telephone.

### Remote Code

---

A confidential three digit code is required to listen to your messages from a remote external telephone. The default remote code is 123. For security reasons it is advisable to change this code.

Press **'MENU'** soft key

Use ▲ and ▼ to select **'TAM SETUP'**

Press **'SELECT'** soft key

Use ▲ and ▼ to select **'SECURITY ID'**

Press **'SELECT'** soft key

The current remote code will be displayed on the LCD.  
Enter the new code that you wish to use

Press **'SAVE'** soft key

# ANSWERING MACHINE

## Remote Control

---

Call the answering machine (using your telephone number)

While the outgoing message is playing, enter the remote code

If the remote code is accepted, the system will play the menu of commands. You can then follow the voice prompt to operate

When you have finished accessing the machine replace the handset.

## Remote Control Commands

---

### Command Functions

|         |                                      |
|---------|--------------------------------------|
| 2       | Play new messages                    |
| 2 twice | Stop playback                        |
| 0       | Erase single message during playback |
| 1       | Review                               |
| 3       | Skip to next message                 |
| 4       | Switch the answering machine on/off  |
| 7       | Repeat the menu again                |

## Recording a Memo

---

You can leave a memo for other answering machine users (up to 3 minutes).

To record the memo, press and hold the **MEMO** key in standby mode. The display will show '**RECORDING MEMO**' and start the recording. The **MEMO** key should be pressed and held down whilst recording. Release the **MEMO** key to end the recording.

# ANSWERING MACHINE

The message can be played by pressing  of the answering machine or via the remote access function using a normal telephone.

## **Out of Memory**

---

The total capacity of the answering machine's memory is approximately 40-50 minutes. The memory space is shared between the outgoing message, personal memos, and regular incoming messages. If the memory is full, the answering machine will answer after 10 rings to allow remote playback and deletion of messages, no new messages will be accepted until the existing messages have been played and erased.

# TROUBLESHOOTING

## **No display**

- Make sure that the power adaptor is plugged in correctly and is not damaged
- Check for a power cut in the area

## **Ampli455 does not ring**

- Make sure that the telephone line cord is plugged in correctly and is not damaged
- Connect another telephone to the telephone PTT socket or move your telephone to another socket to track if the failure is coming from your telephone or your PTT socket
- There may be too many communication devices connected to a single telephone line e.g. another telephone, modem or facsimile machine. Contact your network provider for help in calculating the limit for your home or business line
- Check the Ringer is not switched to OFF
- Check the Volume level of the ringer

## **No dial tone**

- Make sure that the telephone line cord is plugged in correctly and is not damaged
- Connect another telephone to the telephone PTT socket or move your telephone to another socket to track if the failure is coming from your telephone or your PTT socket
- There may be too many communication devices connected to a single telephone line e.g. another telephone, modem or facsimile machine. Contact your network provider for help in calculating the limit for your home or business line
- Check that the dialing mode is set to the correct setting (tone or pulse)

## **Interference on the line**

- Ensure a filter is fitted to all telephone sockets if you have a DSL line

## **No Caller ID information displayed**

- Ensure you have requested the Caller ID service from your network provider

## **No Amplification**

- Check the Amplify key has been pressed and the LED is lit (red).

# SAFETY INFORMATION

## **General**

Only use the power supply included with the product.

Do not open the unit. Contact the helpline for all repairs.

The phone is capable of amplifying sounds to a loud volume. It is important to instruct all potential users of its proper operation. It is advised to adjust the volume control to its minimum level (Low) when not in use and alert other users that hearing damage can potentially result from misuse

## **Cleaning**

Clean the telephone with a soft cloth. Never use polishes or cleaning agents - they could damage the finish or the electrics inside.

## **Environmental**

Do not expose to direct sunlight.

Always ensure there is a free flow of air over the surfaces of the telephone.

Do not place any part of your product in water and do not use it in damp or humid conditions e.g. bathrooms.

Do not expose your product to fire or other hazardous conditions.

Unplug your phone from the telephone socket during thunderstorms because it could damage your telephone. Your guarantee does not cover thunderstorm damage.

The telephone is designed for working within a temperature range of 5°C to 45°C.

# REGULATORY COMPLIANCE

- This equipment complies with Part 68 of the FCC rules and the requirements adopted by the ACTA. On the bottom of this equipment is a label that contains, among other information, a product identifier in the format US:AAAEQ##TXXXX. If requested, this number must be provided to the telephone company.
- All applicable certification jacks Universal Service Order Codes (USOC) for the equipment is provided (i.e. RJ11C) in the package with each piece of approved terminal equipment.
- A plug and jack used to connect this equipment to the premises wiring and telephone network must comply with the applicable FCC Part 68 rules and requirement adopted by the ACTA. A compliant telephone cord and modular plug is provided with this product. It is designed to be connected to a compatible modular jack that is also compliant. See installation instructions for details.
- The REN is useful to determine the quantity of devices you may connect to your telephone line and still have all of those devices ring when your telephone number is called. In most, but not all areas, the sum of the REN's of all devices connected to one line should not exceed five (5.0). To be certain of the number of devices you may connect to your line, as determined by the REN, you should contact your local telephone company to determine the maximum REN for your calling area.
- If this equipment causes harm to the telephone network, the telephone company will notify you in advance that temporary discontinuance of service may be required. But if advance notice isn't practical, the telephone company will notify the customer as soon as possible. Also, you will be advised of your rights to file a complaint with the FCC if you believe it is necessary.
- The telephone company may make changes in its facilities, equipment, operation or procedures that could affect the operation of the equipment. If this happens the telephone company will provide advance notice in order for you to make necessary modifications to maintain uninterrupted service.
- This equipment may not be used on coin service provided by the telephone company. Connection to party lines is subject to state tariffs. This equipment is hearing aid compatible.



# REGULATORY COMPLIANCE

**Warning:** Changes or modifications to this unit not expressly approved by the party responsible for compliance could void the user's authority to operate the equipment.

**NOTE:** This equipment has been tested and found to comply with the limits for a Class B digital device, pursuant to Part 15 of the FCC Rules. These limits are designed to provide reasonable protection against harmful interference in a residential installation. Some cordless telephones operate at frequencies that may cause interference to nearby TV's and VCR's; to minimize or prevent such interference, the base of the cordless telephone should not be placed near or on top of a TV or VCR; and, if interference is experienced, moving the cordless telephone farther away from the TV or VCR will often reduce or eliminate the interference. However, there is no guarantee that interference will not occur in a particular installation. If this equipment does cause harmful interference to radio or television reception, which can be determined by turning the equipment off and on, the user is encouraged to try to correct the interference by one or more of the following measures:

- Reorient or relocate the receiving antenna.
- Increase the separation between the equipment and receiver.
- Connect the equipment into an outlet on a circuit different from that to which the receiver is connected.
- Consult the dealer or an experienced radio TV technician for help.

- If trouble is experienced with this equipment, for repair or warranty information, please contact our customer service staff at: 1-888-864-2446

If the equipment is causing harm to the telephone network, the telephone company may request that you disconnect the equipment until the problem is resolved.

- Please follow instructions for repairing if any; otherwise do not alter or repair any part of device except as specified.

# REGULATORY COMPLIANCE

**Opening the equipment or any attempt to perform repairs will void the warranty. For service or repairs, call 1-888-864-2446** (CS Green Customer Service key at top has been pre-programmed with our USA customer service number. Press the CS key to direct dial for any Customer Service or technical related help or questions. Our customer service department is available from 9Am-5Pm Monday through Friday Central time.)

- Connection to party line service is subject to state tariffs. Contact the state public utility commission, public service commission or corporation for information.

- If your home has specially wired alarm equipment connected to the telephone line, ensure the installation of this telephone equipment does not disable your alarm equipment. If you have questions about what will disable alarm equipment, consult your telephone company or a qualified installer.

- This equipment is hearing aid compatible.

# GUARANTEE

Sonic Alert warrants the phone against any defect in materials or workmanship for the period of one year from the date of purchase. Should you experience a problem, contact our customer service department

Be sure to save your sales receipt as proof of purchase date should you need warranty service.

Within a period of one year from purchase date, Sonic Alert will repair or replace (our discretion) your phone at no cost, if a defect in materials or workmanship is found. If we elect to replace your phone, we may replace it with a new or reconditioned product of the same or similar design.

Repair or replacement will be warranted for a period of 90 days or the original time on the original warranty, whichever is longer.

The warranty does not cover accidents, negligence or breakage to any parts. This includes shipping damage, failure to follow instructions, misuse, fire, floods, use of incompatible accessories, Acts of God or failure in your phone service carrier's line service. The product must not be tampered with or taken apart by anyone who is not an authorized

Sonic Alert representative. Tampering with the phone will void any written or implied warranties

Sonic Alert shall not be responsible for loss of time, inconvenience, property damage caused by your phone or any other accidental or consequential damages

Warranty service is available only with proof of purchase.

# GUARANTEE

Simply send the Ampli455 (postpaid) and a copy of your sales slip as proof of purchase to:

**Sonic Alert Warranty Center 1081 West Innovation Dr.  
Kearney, MO 64060**

**IMPORTANT : YOUR RECEIPT IS PART OF YOUR WARRANTY  
AND MUST BE RETAINED AND PRODUCED IN THE EVENT  
OF A WARRANTY CLAIM**



## SonicAlert

Sonic Alert Warranty Center  
1081 West Innovation Dr.  
Kearney, MO 64060

Sales: 248-577-5400 Fax: 248-577-5433  
Customer Service & Warranty: 1-888-864-2446

UGAmpli455\_US\_En\_v1.0