



USER'S MANUAL
Part 2

AT&T Small Business System Speakerphone with Digital Answering System and Caller ID/Call Waiting 984



For Customer Service Or Product
Information, Visit Our Website At
www.telephones.att.com

Please also read
**Part 1 — Important
product information**

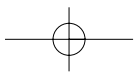
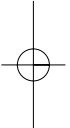
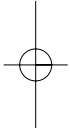

Contents

Product overview	1	Program home and local area codes	40
Before you begin	2	Assign the line group for this phone	41
Parts list	2	Erase all settings and return the phone to default settings	42
Tools needed	2	Set answering system status	43
DSL users	4	Set your phone for single phone operation	44
Glossary	5	Set answer delay	45
Programmable features list	8	Set auto-attendant pickup delay	46
Audible signals	12	Set auto-attendant day and night times	47
Installation	13	Turn toll saver on or off	49
Battery installation	13	Program the remote code	50
Table/desk installation	15	Set message length	51
Wall installation	17	Turn audible message alert on or off	52
Convenience ports	21	Turn monitor on or off	53
Menu operation	22	Turn DTAD intercept on or off	54
Menu structure	23	Set this phone to be the Centrex console phone	55
Shortcut to language menu	24	Set the Centrex console delayed ring time	56
Rapid scroll	24	Set the display language	56
Feature setup	25	Telephone operation	57
Set one touch preference	25	Make or answer a call	57
Assign an extension number to your phone	26	Switch between handset, headset and speakerphone	59
Turn the ringer on or off for each line	27	Timer	59
Select the ringer type	28	Call privacy	60
Set delay ring	29	Do not disturb	60
Turn auto-mute on or off	30	Volume	61
Set dial mode	31	Redial	61
Turn hold reminder on or off	31	Redial stack	62
Set the time and date	32	Auto redial	62
Turn line usage on or off for each line	33	Hold	63
Assign the prime line (line preference)	34	Switch between lines	63
Set automatic mode	35	Mute	64
Set the scroll rate	36	Flash	64
Turn screen backlight on or off	37	Temporary tone dialing	64
Turn COVM indicators on or off for each line	38		
Reset COVM indicator	39		

Contents

Conference calls	65	lines simultaneously	93
Transfer a call	66	Display screen messages	94
Low battery indicator	67	Message waiting and NEW CALL light	95
Lights and what they mean	68	Call history	95
One touch operation	70	Remove calls from call history	97
Store a number in a one touch location	71	Dial a number from call history	98
Review a one touch entry	73	Save a name and number from call history to the directory	99
Dial a one touch number	74	Save a number from call history to a one touch location	100
Directory operation	75	Answering system	
Menu structure	75	DTAD operation	101
Store a name and number in the directory	76	Turn answering system on or off	101
Review directory entries	79	Enter DTAD mode	101
Edit a directory entry	80	Menu structure	102
Dial a number from the directory	81	Record an outgoing announcement	103
Remove a name and number from the directory	81	Review an outgoing announcement	104
Remove all entries from the directory	82	Remove an outgoing announcement	105
Intercom operation	83	Monitor incoming calls	105
Basic intercom operations	84	Intercept an incoming message	105
Make an intercom call with the handset	85	Listen to your messages	106
Make an intercom call with the speakerphone or headset	86	Remove messages	108
Answer an intercom call	87	Record a memo	108
End an intercom or page call	87	Record a phone conversation	109
Page a specific extension (single-phone page)	88	Audible message alert	109
Answer a single-phone page	88	Answering system	
Page all system phones	89	Auto-attendant operation	110
Answer a system-wide page	89	Auto-attendant sequence for callers	111
Make an intercom conference call	90	Review an auto-attendant outgoing announcement	112
Room monitor	90	Record an auto-attendant outgoing announcement	113
Caller ID operation	91		
Menu structure	92		
Caller ID display	92		
Call waiting	93		
Calls received on two or more			

Remove an auto-attendant
outgoing announcement 114

Using multiple
auto-attendants 115

Answering system

Remote operation 116

Connect with the
answering system 116

Remote commands 117

Adding a fax machine 118

Using a fax switch 118

General product care 119

Technical specifications 120

In case of difficulty 121

**Expanding the phone
system** 128

Line groups 128

Private lines 130

Centrex operation..... 131

Setup checklist 131

Enable the console phone 131

Console operation 131

Set ring delay duration 132

Answer a delayed ring 132

Pick up another station's line 132

Index 133

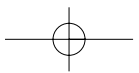
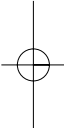
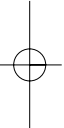

Product overview

This AT&T Small Business System Speakerphone with Digital Answering System and Caller ID/Call Waiting 984 is expandable to a 16-extension telephone system. The 984 is compatible with AT&T 945, 974, 944, 955 and 964 telephones. (See Before you begin starting on page 2 and Expanding the phone system beginning on page 128 for details.)

The 984 is hearing-aid compatible and can be connected to up to four incoming telephone lines. This phone features a speakerphone for hands-free use and a headset jack compatible with most two-band 2.5mm headsets (sold separately). The 984 allows paging, intercom and call transfers between system phones and is capable of connecting three parties in a conference call. This phone also features a 32-number memory for faster dialing and has a directory which can store up to 200 additional numbers with names. This phone has a caller ID feature which supports caller ID with call waiting service. (Caller ID services are subscriber services available from many local telephone companies for a fee.) There are two convenience ports available for connecting the phone to another device such as a fax machine or modem.

Your 984 also features a built-in digital answering system which can store approximately 20 minutes of messages, memos, phone calls and announcements for a total of up to 99 messages. You can access the answering system from a remote, non-system touch tone phone or from another system phone. This 984 telephone is equipped to function as an auto-attendant in a multi-phone system. An auto-attendant phone can pick up and redirect incoming calls to other extensions in your phone system. You may designate more than one auto-attendant for your phone system. (See Answering system Auto-attendant operation beginning on page 110 for details.)

The 984 is compatible with Centrex service. Centrex is a special subscriber service which may be available from your local telephone company for a fee. If you subscribe to Centrex service, refer to the Centrex operation section of this manual, beginning on page 130.

This user's manual contains detailed instructions for installing, programming and operating your AT&T Small Business System Speakerphone with Digital Answering System and Caller ID/Call Waiting 984. Please be sure to read Before you begin starting on page 2 before installing this phone.

Before you begin

Before you begin

Parts list

Your box should include:

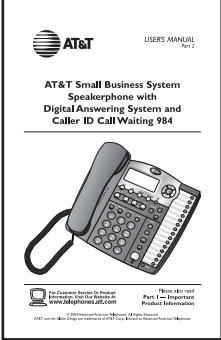

This user's manual

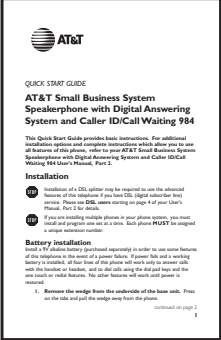

Quick start guide



Wallet card



One short line cord

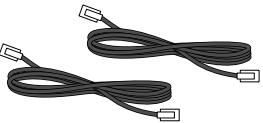

Two long line cords

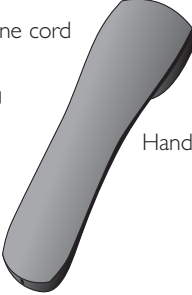

Handset



Base unit with wedge attached



Coiled handset cord

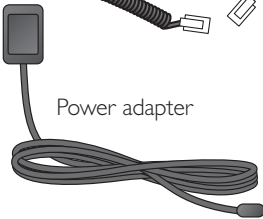

Power adapter

Tools needed

You will also need a small Phillips head screw driver to install your phone.

This 984 telephone is fully compatible with any AT&T Four-Line Small Business System Speakerphone 945 or 974 units you may have installed. You can use a total of 16 945/974/984 units together as extensions in your phone system.

This 984 telephone is also compatible with any AT&T 964/955/944 phones you have previously installed. This 984 telephone is **NOT** compatible with any 843, 853, 854, 874, or 954 telephones you may have previously installed.

 **NOTE:** If you have one or more 964, 955, or 944 phone(s) installed in the same phone system with this 984 telephone, you can have only 12 extensions and 15 telephone lines in the phone system.

- You must have a modular telephone jack and an electrical outlet not controlled by a wall switch near where you're installing the phone.



The total length of telephone wiring used in this system **MUST NOT** be more than 600 feet as it may cause interference with the advanced features of this telephone.

- Identify the number of phone lines you'll use.
- Plan the layout of your phone system.
- All connected phones must have the same line 1 phone number for the intercom and paging features to work.



Every individual phone in your telephone system **MUST** be assigned a unique extension number for the intercom feature to work. If you try to assign the same extension number to a second phone, you will hear a repeating short ring and the screen display will include EXT XX is already used Assign new EXT # if the phone is in idle mode. If the phone is in the programming mode, you will hear the repeating short ring only. See **Assign an extension number to your phone** on page 26 of this manual for directions.

- Decide if you want a private line. A private line does not appear on all connected phones.
- Choose your setting for each feature. You will need to program the features after installation. See **Programmable features list** beginning on page 8 for a brief description of the features. See the Feature setup section beginning on page 25 for programming instructions.

Before you begin

DSL users

Connecting a DSL line to L1/L2 may interfere with the advanced features of this telephone, (such as intercom, hold, and line privacy,) which work by sending data signals over line 1. These data signals are sent at some of the same frequencies as those used by your DSL service.

Also, DSL lines usually have microfilters, which keep the DSL signals from interfering with your telephone's sound quality. These same microfilters will also block the data signals that this telephone system uses to support some telephone system features. Therefore, the advanced features of this phone may not work properly when DSL microfilters are installed on L1/L2 of your phone system. However, you can use a DSL splitter to prevent these problems.

For only one or two DSL lines, install it/them into L3/L4 on the back of the phone.

If your system will only use two or three phone lines, plug a single non-DSL telephone line into L1/L2. (Turn off the L2 line usage lights.) Be sure to use the microfilter(s) which were probably provided when DSL was installed, on lines 3 and/or 4 if the lines have DSL, to protect the sound quality.

If you have two telephone lines, one of which is DSL, which both appear at a single wall jack, use a Triplex adapter to separate the lines at the wall jack. Call **1 (800) 222-3111** if you need help doing this.

If you must install a DSL line into L1/L2 on the back of the phone, use a DSL splitter.

Lines 1 and 2 share a telephone jack, so if you need to install a DSL line for telephone line 1 or line 2, you will need additional equipment to avoid interference. Any telephone line connected to L1/L2 cannot have a microfilter. It must have a DSL splitter. Use a dual line DSL splitter or a two-line DSL filter. Call **1 (800) 222-3111** if you need help doing this.

Installation, by your DSL service provider or other professional, of a DSL splitter (not a microfilter) as close as possible to the protection block or network interface (where the telephone line enters the house) may resolve DSL interference. (It may be necessary to use a DSL splitter intended for outdoor use.) A DSL splitter allows the data and voice signals to use the same telephone line without interfering with each other.

AT&T cannot supply the DSL splitter. Please contact your DSL service provider or professional contractor for details about obtaining and installing a DSL splitter. Your DSL service provider may require you to bear any installation costs. AT&T and the manufacturer of this product have no affiliation with your DSL provider and the type or quality of services they offer. Installation must be performed at your own expense and AT&T cannot troubleshoot or provide installation support.

NOTE: If your DSL service provider cannot supply a DSL splitter, it is possible to purchase an outdoor DSL splitter over the Internet.

If you are a new DSL customer, your DSL service provider will probably ask you if you have more than one telephone line in your home or business, or if you are installing a phone system. If you answer yes, your DSL service provider will probably advise you that you need a splitter. In most cases, your DSL service provider will supply you with the proper splitter for your specific situation. The DSL splitter, installed properly, should help overcome any interference between the DSL signal and the signals sent by your phone system.

AT&T shall not be responsible for the cost of installation, any damages, lost business, direct or indirect expenses accrued or associated with installation, or other compatibility issues which may arise as a result of using this product while you subscribe to DSL service.

Glossary

Auto-attendant: The 984 phone in your multi-phone system is designated to pick up a ringing line automatically after a selected number of rings. The auto-attendant plays the selected outgoing announcement and redirects the call if the caller enters an extension number. You can designate up to 16 auto-attendants in your phone system.

Caller ID: Caller identification is a subscriber service available from most local telephone companies for a fee. When you subscribe to caller identification, you can see who's calling before you answer the phone if you and the caller are both in areas offering caller ID service with compatible equipment.

Caller ID with call waiting: This is a single, combined subscriber service which may be available from your local telephone company. If you subscribe to this service, you can use your 984 telephone to see who's calling even while you are on another call (as long as your caller is in an area with caller ID service and both telephone companies use compatible equipment).

Centrex service: A special subscriber service which may be available from your local telephone company for a fee. This 984 telephone can be used with Centrex service.

COVM: Central Office Voice Mail is a subscriber voice message service which may be available from your local telephone company. This service may be called by another name in your area (e.g. call answering).

continued on page 6

Before you begin

Glossary

continued from page 5

DND: When activated, the Do Not Disturb (DND) feature prevents interruptions during a call.

DTAD: The Digital Telephone Answering Device is a sophisticated, tapeless answering system built into the 984 telephone.

Home area code: This is the area code for your telephone number. Most users simply dial the seven digits of a phone number to make a call within their own area code and 11 digits outside of their area code. If this applies to you, you should enter your own area code into the unit as the home area code. After programming, if you receive a call from within your home area code, the screen will display the seven digits of the phone number. You may, however, live in a region where for calls within your own area code, you must dial 10 digits (that is, the area code and phone number). If this applies to you, enter **000** for the home area code and enter your area code as a local area code. After programming, if you receive a call from within your area code, the screen displays the 10 digits of the phone number.

Be sure to follow the directions under **Program home and local area codes** on page 40 during feature setup.

Line group: A group of system phones sharing some lines within a multi-phone system.

Local area code: Most users dial 11 digits to make calls outside their home area codes. If this applies to you, you do not need to program any local area codes.

However, if you dial only 10 digits to make calls to some areas outside your home area code (without dialing **1**), then program these local area codes into the phone. Up to five local area codes can be programmed. See **Program home and local area codes** on page 40 during feature setup for instructions.

After programming, if you receive a call from one of these local area codes, the screen displays the 10 digits of the phone number.

Navigation buttons: These are the buttons used when programming your 984 phone and for scrolling through feature options (**ENTER**, **▲**, **▼**, **▶**, **◀**).

Phone system: Two or more system phones combined to form an interacting system of shared lines. You can have up to 16 system phones in the system.

NOTE: If you have one or more 964, 955, or 944 phone(s) installed in the same phone system with this 984 telephone, you can have only 12 extensions in the phone system.

Prime line: This is the line on your phone you designate to be selected automatically when you lift the handset, press **SPEAKER**, or press **HEADSET**.

System phone: Any 944, 945, 955, 964, 974 or 984 phone in your phone system (also called an extension).

Before you begin

Programmable features list

Default settings indicated by *.

Feature:	Function:	Options:
One touch preference	Choose default mode for one touch (EXT) buttons.	Intercom* or telephone
Extension no.	Assign an extension number to this phone.	11*-26
Ringer on/off	Turn the ringer on or off for each line.	On* or off
Ringer type	Select a ring pattern for this phone.	Type 1*, 2, 3, 4
Delay ring	Select desired time to delay central office ring.	Off*, 2, 4, 6, up to 30 seconds
Auto-mute	Turn auto-mute on or off (sounds at this extension will be heard automatically when paged).	On* or off
Tone/pulse	Set the dial mode for touch tone or dial pulse (rotary) dialing.	Tone* or pulse
Hold reminder	Turn on or off the audible reminder that a call at this extension is on hold.	On* or off
Time/date	Set the time and date.	01:00 AM 01/01 Sunday*
Line usage	Turn line usage on or off for each line.	On* or off

Ⓢ **NOTE:** One ring lasts about six seconds, two rings last twelve seconds, and so on.

Programmable features list

Default settings indicated by *.

Feature:	Function:	Options:
Prime line	Assign a line on this phone to be selected automatically when you lift the handset, press SPEAKER , or press HEADSET .	Line 1*, 2, 3, 4
Automatic mode	Choose default mode for calls connected with the handset in the base unit.	Speakerphone* or headset
Scroll rate	Set the scrolling speed for rapid scroll.	Very slow, slow, medium*, fast, or very fast
LCD backlight	Turn the screen display backlight on or off.	On* or off
COVM on/off	Turn COVM (message/voice mail) indicators on or off for each line.	On or off*
COVM reset	Clear COVM indicators when they are lit but no new messages are waiting.	N/A
Area codes	Program one home and up to five local area codes for use with caller ID features.	1-3 digits, empty*
Line group	Assign your phone to a line group.	Line group 4*-15 or PRV (private)

NOTE: One ring lasts about six seconds, two rings last twelve seconds, and so on.

continued on page 10

Before you begin

continued from page 9

Programmable features list

Default settings indicated by *.

Feature:	Function:	Options:
Reset all	Return all features to default settings.	N/A
Answer status	Turn the answering system on or off, or set this phone to be an auto-attendant. Set answer status to on to activate answering system in a single phone system. Set answer status to auto-attendant to activate answering system and auto-attendant functions for a multi-phone system.	On*, off, or auto-attendant
Single phone	Specify whether this phone is single (on) or part of a multi-phone system (off).	On or off*
Answer delay	Set the length of time this phone rings before the answering system picks up the call.	02-60 seconds. 15 seconds*
Auto ATT delay	Specify how long an auto-attendant waits before picking up incoming calls.	6*-30 seconds
Day/night times	Specify times to be considered day or night for auto attendant features.	Day: 09:00 AM* Night: 06:00 PM*

NOTE: One ring lasts about six seconds, two rings last twelve seconds, and so on.

Programmable features list

Default settings indicated by *.

Feature:	Function:	Options:
Toll saver	Turn toll saver on or off.	On or off*
Remote code	Program the code (password) needed for remote access to some features of your phone.	Three digits, III*
Message length	Set maximum length of recorded messages.	Unlimited*, 1 minute, or greeting only
Message alert	Turn the audible message alert on or off.	On or off*
Monitor	Choose whether incoming messages can be heard over the speaker as they are recorded.	On* or off
DTAD intercept	Choose whether messages can be intercepted by other phones during recording.	On or off*
Console	Specify whether your phone is the Centrex console phone for your phone system.	On or off*
CSL delay ring	Set the time to delay ring for Centrex console phone.	Off*, 2, 4, 6, up to 30 seconds
Language	Select the language for screen displays.	English*, Spanish, or French

 **NOTE:** One ring lasts about six seconds, two rings last twelve seconds, and so on.

Before you begin

Audible signals

When you hear:	It means:
A rapid double-ring pattern, repeating	You have an incoming intercom call.
A long single ring, repeating	You have an incoming transferred call.
A short single ring, repeating	The extension number you just programmed has already been assigned. Choose another number for this extension.
A short single tone, repeating	The extension you are calling is in DND mode.
A long single tone, repeating	The extension you are calling is busy.
A very long single tone, repeating	The extension you are calling is ringing or in DND mode.

Installation



If you are installing multiple phones in your telephone system, you must install and program one set at a time. If more than one extension is assigned the same extension number, a repeating short ring (error ring) sounds at the extension you are programming and the screen display includes **EXT XX is already used Assign new EXT #** if the phone is in idle mode. If the phone is in the programming mode, you will hear the repeating short ring only. Assign a different extension number from 11 to 26 (see **Assign an extension number to your phone** on page 26).

Battery installation

Install a 9V alkaline battery (purchased separately) in order to use some features of this telephone in the event of a power failure. If power fails and a working battery is installed, all four lines of this phone will work only to answer calls with the handset or headset, and to dial calls using the key pad and the one touch or redial features. No other features will work until power is restored.

1. Remove the wedge from the underside of the base unit.

Press on the tabs in the direction of the arrows and pull the wedge away from the phone.

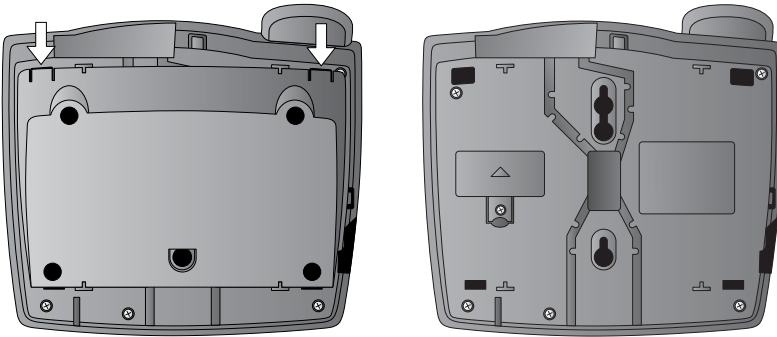

2. Remove the battery compartment screw with a small Phillips head screwdriver.

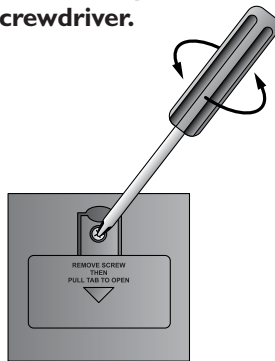

continued on page 14

Battery installation

continued from page 13

3. Pull on the tab to remove the battery compartment cover.

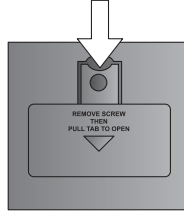

4. Insert a 9V battery (purchased separately) following the polarity markings in the battery compartment.

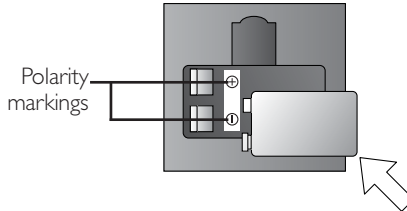

5. Replace the battery compartment cover and the screw.
 6. If you are wall mounting the phone, turn to **Wall installation** beginning on page 17. (You will not need the wedge; store it in case you use the phone on a table or desk in the future.)

—OR—

If you are using the phone on a table or desk, reattach the wedge to the base unit by sliding the tabs into the holes as shown. Snap the wedge onto the base. Then, turn to **Table/desk installation** beginning on page 15.

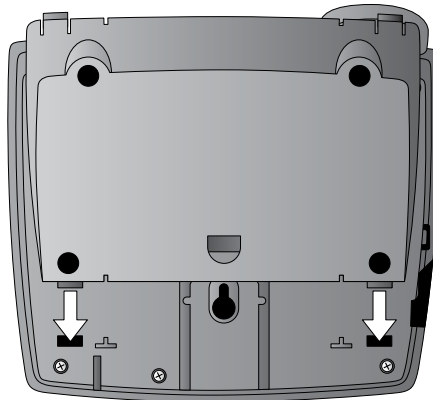

Table/desk installation

For best results, follow the directions in **Battery installation** beginning on page 13 before installing the phone.

Recommended wiring configuration for phone system

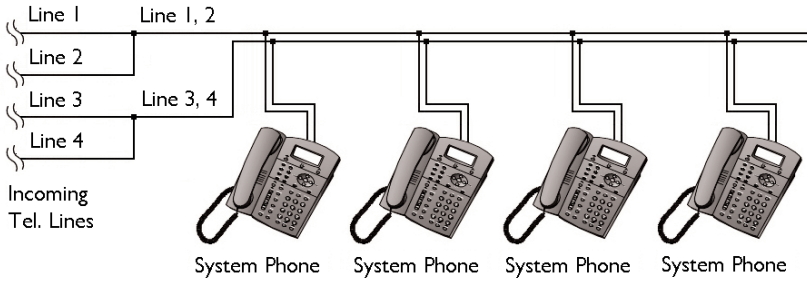

NOTE: The total length of telephone wire used in your system should not be more than 600 feet as it may cause interference with the advanced features of this telephone.

NOTE: Users should use **ONLY** the line cords provided. In case additional line cords are required, please use **ONLY** AWG#24 line cords.

1. **Connect the telephone line cords to the telephone and wall jacks as shown in the following illustration on page 16.**

continued on page 16

Table/desk installation

continued from page 15

- **Four one-line jacks** (To use this installation option, you'll need to purchase two two-line adapters. Adapters are available at retail stores or by calling **1 (800) 222-3111.**)

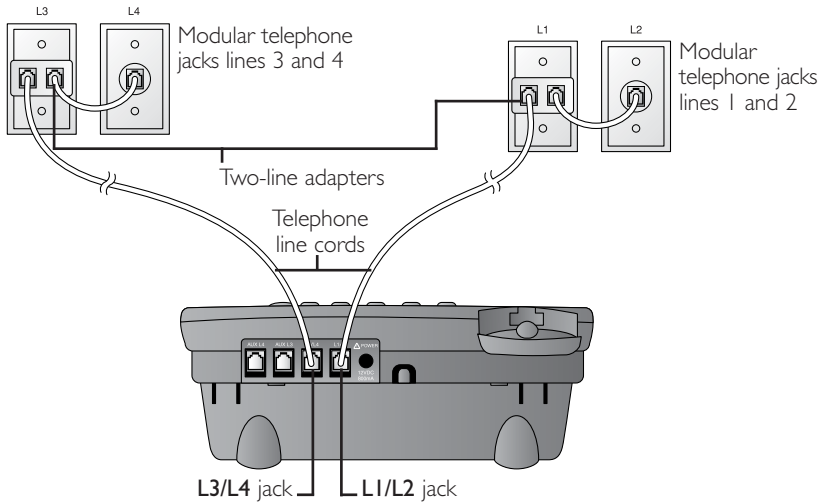

- **Two two-line jacks**

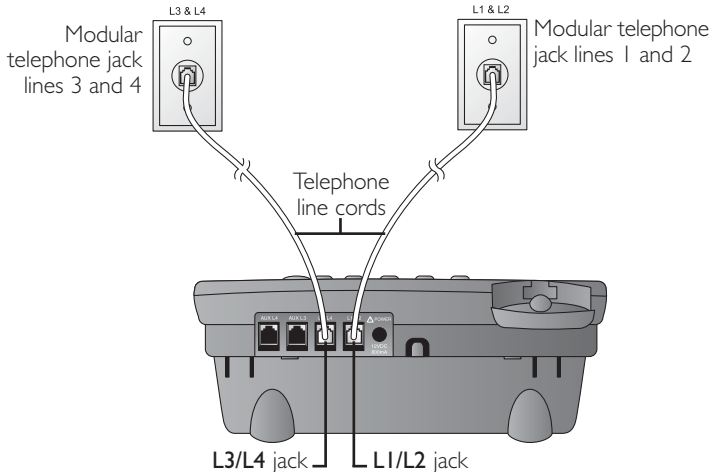
**2. Connect the handset cord.**

Plug one end of the coiled handset cord into the jack on the left side of the phone. Plug the other end into the handset and hang up.

3. Connect the power adapter to the telephone.



Use only the power adapter provided with this product. To obtain a replacement, call **1 (800) 222-3111**.

Plug one end of the power adapter into the jack labeled **POWER** on the back of the phone. Plug the other end into a standard electrical outlet not controlled by a wall switch.

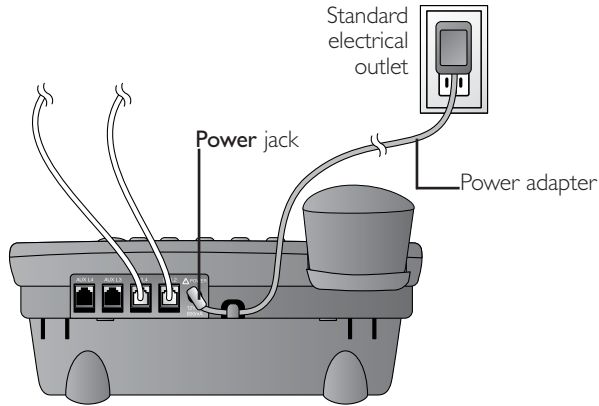

4. Initialization.

If no battery is installed when you connect the power cord, the phone runs a quick self-test and the screen displays *Initializing* for about three seconds.

NOTE: The phone will run through this same initialization any time it is reconnected to AC power if a working battery is not installed (for example, after a power failure or when the unit has been unplugged).

5. Check for dial tone.

Lift the handset and listen for a dial tone. If you cannot hear a dial tone, turn to *In case of difficulty* beginning on page 121.

Wall installation

For best results, follow the directions in **Battery installation** beginning on page 13 before installing the phone.

1. **If the wedge is still attached to the underside of the base unit**, follow **step 1** in **Battery installation** on page 13 to remove the wedge.

continued on page 18

Wall installation

continued from page 17

2. Reverse the handset tab.

Hold down the switchhook, then pull out the handset tab and rotate it 180 degrees. Push the handset tab down into the grooves so it settles into position.

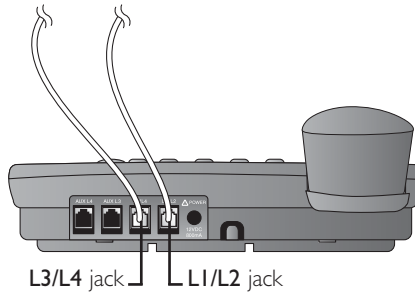
**3. Connect the telephone line cords to the telephone as shown.****4. Connect the handset cord.**

Plug one end of the coiled handset cord into the jack on the left side of the phone. Plug the other end into the handset and hang up.

5. Connect the power adapter to the telephone.

Use only the power adapter provided with this product. To obtain a replacement, call **1 (800) 222-3111**.

Plug one end of the power adapter into the jack labeled **POWER** on the back of the phone. Plug the power adapter into a standard electrical outlet not controlled by a wall switch.

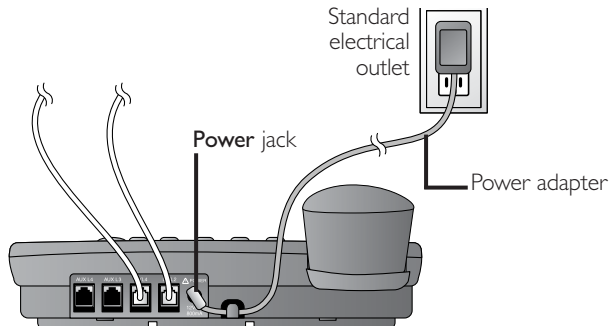

6. Connect the telephone line cords to the wall jacks as shown in the following illustration and mount the phone on the wall.

NOTE: Users should use ONLY the line cords provided. In case additional line cords are required, please use ONLY AWG#24 line cords.

- **Four one-line jacks** (To use this installation option, you'll need to purchase two two-line adapters. You will also need to purchase and install a blank wall plate. Adapters and blank wall plates are available at retail stores or by calling **1 (800) 222-3111**.)

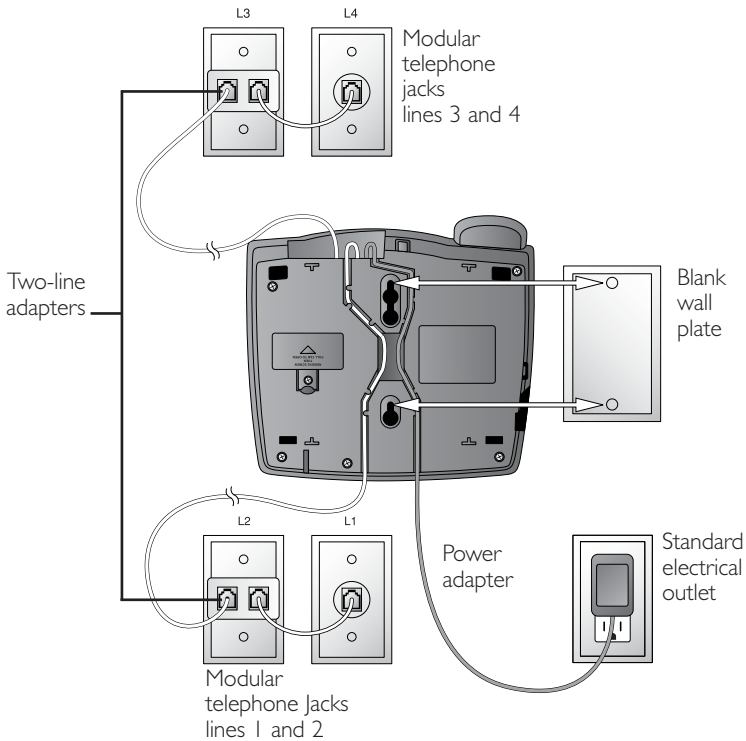

continued on page 20

Wall installation

continued from page 19

- **Two two-line jacks** (To use this illustration option, you may want to use the short line cord for lines 1 and 2.)

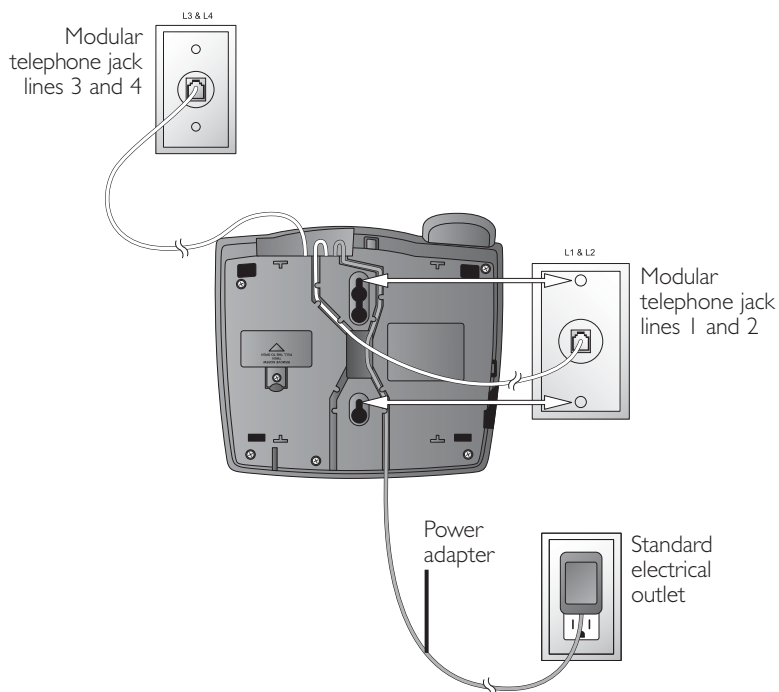
**7. Initialization.**

If no battery is installed when you connect the power cord, the phone runs a quick self-test and the screen displays **Initializing** for about three seconds.

🎯 **NOTE:** The phone will run through this same initialization any time it is reconnected to AC power if a working battery is not installed (for example, after a power failure or when the unit has been unplugged).

8. Check for dial tone.

Lift the handset and listen for a dial tone. If you cannot hear a dial tone, turn to **In case of difficulty beginning on page 121.**

Convenience ports

If you want to connect another device (such as a modem or fax machine) to the wall jack, you can use the jacks on the phone labeled **AUX**. These convenience ports use lines 3 and 4; a call picked up on line 3 or 4 at another extension may interrupt fax, modem, or message transmission.

- **Four one-line jacks**

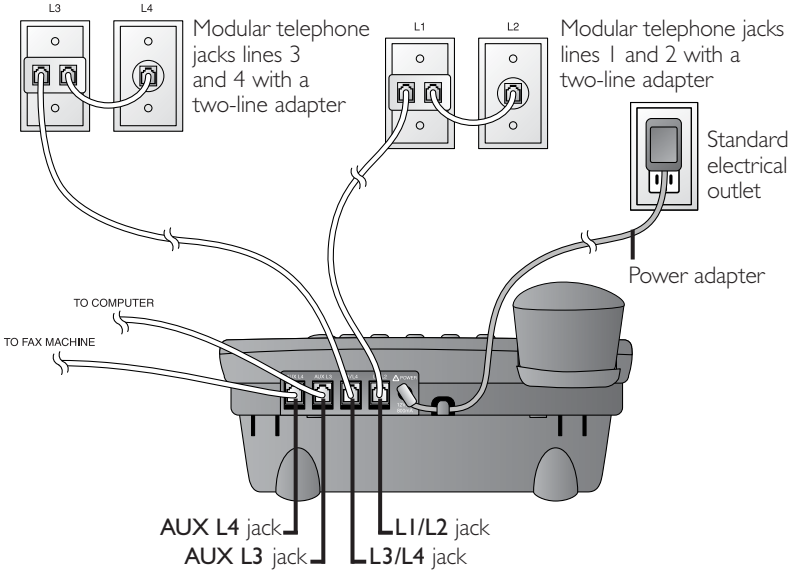

- **Two two-line jacks**

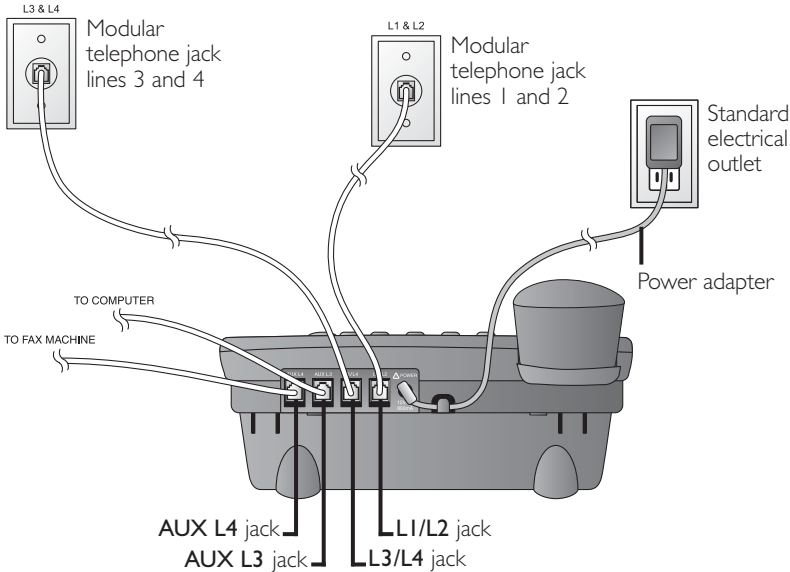

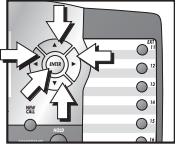

Menu operation

Feature setup, memory programming and some individual feature operations for the 984 use menus shown in the screen display. Use the navigation buttons (◀, ▶, ▲, ▼, **ENTER**) to begin, end and move through menu operations (for example, feature setup).

- Press **ENTER** to activate a menu operation. The first menu item for this topic or data will appear in line four of the screen. For example, the screen displays:

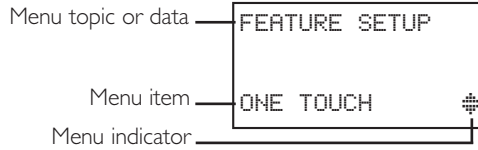

NOTE: If you do not press a key to continue menu operations within 30 seconds, the telephone automatically exits the menu.

- When **#** is displayed, you can press the ▼ or ▲ button repeatedly to move through the menu.
- Press **ENTER** to choose the menu item currently displayed. This may be a lower level menu, an action, or a feature settings screen. For example:

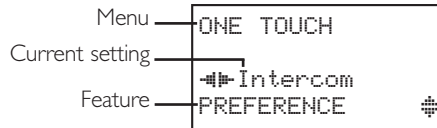

- When **#** is displayed, you can press the ▶ or ◀ button to scroll through setting choices.
- Press **ENTER** to store the setting, or press ▼ to store the setting and show the next option for the feature currently displayed.
- To return to the main menu, press the ▼ or ▲ button until the screen display includes MAIN MENU or EXIT. Then, press **ENTER**.
- To exit programming mode, press and hold **ENTER**.

NOTE: If the phone beeps twice, repeat the steps to program the feature.

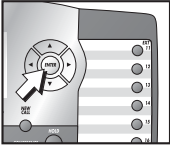

Menu structure

Use the menu operation to set up the values for the 984 features. Access the menu by pressing **[ENTER]** when the phone is idle. The menu structure for the feature setup menu is shown below.

- One touch
 - Preference
 - Intercom
 - Telephone
 - Program
 - Pause
 - Tone
 - Flash
 - Cancel
 - View
 - Done
 - Main menu
- Phone settings
 - Extension no.
 - Ringer on/off
 - Ringer type
 - Delay ring
 - Auto-mute
 - Tone/pulse
 - Hold reminder
 - Main menu
- Time/date
- Special options
 - Line usage
 - Prime line
 - Automatic mode
 - Scroll rate
 - LCD backlight
 - COVM on/off
 - COVM reset
 - Area codes
 - Line group
 - Reset all
 - Main menu
- DTAD/AA
 - Answer status
 - Single phone
 - Answer delay
 - Auto ATT delay
 - Day/night times
 - Toll saver
 - Remote code
 - Message length
 - Message alert
 - Monitor
 - DTAD intercept
- Centrex
 - Console
 - CSL delay ring
 - Main menu
- Language
- Exit

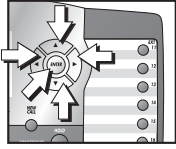

Shortcut to language menu

This phone comes programmed for English screen displays. If you need to change the screen language to Spanish or French, you can use these steps to reach the LANGUAGE menu more quickly.

1. Press **ENTER** to begin feature setup.
2. Press **▲** twice. The screen display includes LANGUAGE and the current setting.
3. Press **◀** or **▶** to scroll through the language choices (English, Español, or Français). When the language you want to use is displayed, press **▼** to save your choice. The screen display includes EXIT.
4. Press **ENTER** to return to the idle screen.

NOTE: You can exit feature setup and return to the idle screen any time. Simply press and hold **ENTER**.

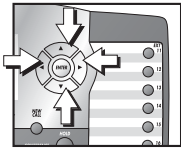

Rapid scroll

You can scroll through menu items or setting choices more quickly using this feature. Press and hold the desired scroll button (**▲**, **▼**, **▶** or **◀**). The screen will scroll through your choices at the rate you program during feature setup. See **Set the scroll rate** on page 36 for programming instructions.

Feature setup

Set one touch preference

Choose whether pressing an EXT button automatically initiates an intercom or one touch call. If you want to place one touch calls using only one button, set this feature to TELEPHONE. If you want to place intercom calls using only one button, set this feature to INTERCOM. See One touch operation beginning on page 70 and Intercom operation beginning on page 83 for details about one touch and intercom calls.

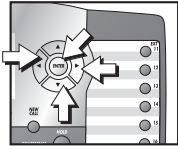

1. Press **ENTER** to begin feature setup.
2. Press **ENTER**. The screen display includes PREFERENCE and the current setting.
3. Press **◀** or **▶** to toggle between INTERCOM and TELEPHONE.
4. When the correct setting is shown, press **▼** to save your choice. The screen display includes PROGRAM.
5. Press and hold **ENTER** to return to the idle screen.

NOTE: You can exit feature setup and return to the idle screen any time. Simply press and hold **ENTER**.

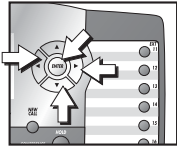

Assign an extension number to your phone

Every individual phone in your telephone system **MUST** be assigned a unique extension number for the intercom feature to work.

1. Press **ENTER** to begin feature setup.
2. Press **▼** until the screen display includes **PHONE SETTINGS**.
3. Press **ENTER**. The screen display includes **EXTENSION NO** and the current setting.
4. Press **◀** or **▶** to change the extension number (11 ... 26).
5. When the desired extension number is shown, press **▼** to save your choice. The screen display includes **RINGER ON/OFF**.

Ⓢ NOTE: If you duplicate an extension number already in use, you will hear a repeating short ring (error ring) and the screen display will include **EXT XX is already used Assign new EXT #** if the phone is in idle mode. If the phone is in the programming mode, you will hear the repeating short ring only. Repeat **steps 1-5** at the ringing phone to assign a different extension number (from 11-26).

- 6 Proceed to **step 5** on page 27 to set the next feature (ringer on or off).

—OR—

Press and hold **ENTER** to return to the idle screen.

Ⓢ NOTE: You can exit feature setup and return to the idle screen any time. Simply press and hold **ENTER**.

Turn the ringer on or off for each line

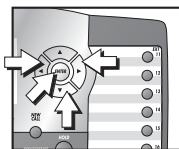

1. Press **ENTER** to begin feature setup.
 2. Press **▼** until the screen display includes **PHONE SETTINGS**.
 3. Press **ENTER**. The screen display includes **EXTENSION NO.**
 4. Press **▼** until the screen display includes **RINGER ON/OFF**.
 5. Press **ENTER**. The screen display includes **L1 RINGER** and the current setting.
 6. Press **◀** or **▶** to toggle between **On** and **Off** for the line shown.
 7. When the desired setting for this line is shown, press **▼** to save your choice. The screen display will include the current ringer setting for the next line (**L1 . . . L4**).
 8. Repeat **steps 6 and 7** to turn the ringer on or off for other lines at this phone.
 9. When you are finished setting the ringer, press **▼** until the screen display includes **DONE**.
 10. Press **ENTER**. The screen display includes **RINGER ON/OFF**.
 11. Proceed to **step 4** on page 28 to set the next feature (ringer type).
- OR—**
- Press and hold **ENTER** to return to the idle screen.

NOTE: You can exit feature setup and return to the idle screen any time. Simply press and hold **ENTER**.

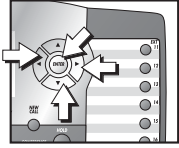

Select the ringer type

You can choose a ring pattern for incoming phone calls.

NOTE: Incoming intercom calls use ringer type 1 and cannot be changed.

1. Press **ENTER** to begin feature setup.
2. Press **▼** until the screen display includes **PHONE SETTINGS**.
3. Press **ENTER**. The screen display includes **EXTENSION NO.**
4. Press **▼** until the screen display includes **RINGER TYPE**.
5. Press **ENTER**. The screen display includes **L1 RINGER TYPE** and the current setting.
6. Press **◀** or **▶** to change the ringer type (Type 1 ... Type 4) for the line shown.
7. When the desired setting for this line is shown, press **▼** to save your choice and move to the next line with its ringer type.
8. Repeat **steps 6 and 7** to set ringer types for other lines on this phone (L1 ... L4).
9. When you are finished setting the ringer type, press **▼** until the screen display includes **DONE**.
10. Press **ENTER**. The screen display includes **RINGER TYPE**.
11. Proceed to **step 4** on page 29 to set the next feature (delay ring).

—OR—

Press and hold **ENTER** to return to the idle screen.

NOTE: You can exit feature setup and return to the idle screen any time. Simply press and hold **ENTER**.

Set delay ring

Set the length of time before incoming calls will ring at this extension.

NOTE: If you choose to set a delayed ring on a phone with voice mail service, the phone may not ring at all before voice mail picks up the call.

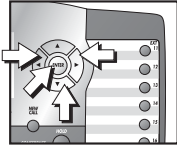

1. Press **ENTER** to begin feature setup.
 2. Press **▼** until the screen display includes PHONE SETTINGS.
 3. Press **ENTER**. The screen display includes EXTENSION NO.
 4. Press **▼** until the screen display includes DELAY RING and the current setting.
 5. Press **◀** or **▶** to change the delay ring setting (Off, 2 sec ... 30 sec).
 6. When the correct delay setting is shown, press **▼** to save your choice. The screen display includes Auto-Mute.
 7. Proceed to **step 5** on page 30 to set the next feature (auto-mute).
- OR—**
- Press and hold **ENTER** to return to the idle screen.

NOTE: You can exit feature setup and return to the idle screen any time. Simply press and hold **ENTER**.

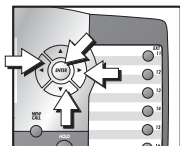

Turn auto-mute on or off

Choose whether sounds at this extension will be heard automatically in response to a page (auto-mute off) or only when **MUTE** is pressed. Auto-mute off permits hands-free conversation and room monitoring; auto-mute on protects privacy.

1. Press **ENTER** to begin feature setup.
2. Press **▼** until the screen display includes **PHONE SETTINGS**.
3. Press **ENTER**. The screen display includes **EXTENSION NO.**
4. Press **▼** until the screen display includes **Auto-Mute** and the current setting.
5. Press **◀** or **▶** to toggle between **On** and **Off**.
6. When the correct setting is shown, press **▼** to save your choice. The screen display includes **TONE/PULSE**.
7. Proceed to **step 5 of Set dial mode** on page 31 to set the next feature (tone/pulse).
—OR—
 Press and hold **ENTER** to return to the idle screen.

NOTE: You can exit feature setup and return to the idle screen any time. Simply press and hold **ENTER**.

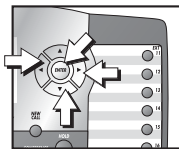

Set dial mode

1. Press **ENTER** to begin feature setup.
2. Press **▼** until the screen display includes PHONE SETTINGS.
3. Press **ENTER**. The screen display includes EXTENSION NO.
4. Press **▼** until the screen display includes TONE/PULSE and the current setting.
5. Press **◀** or **▶** to toggle between Tone and Pulse.
6. When the correct setting is shown, press **▼** to save your choice. The screen display includes HOLD REMINDER.
7. Proceed to **step 5** below to set the next feature (hold reminder).
—OR—
Press and hold **ENTER** to return to the idle screen.

NOTE: You can exit feature setup and return to the idle screen any time. Simply press and hold **ENTER**.

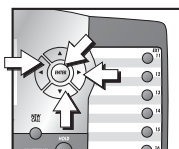

Turn hold reminder on or off

1. Press **ENTER** to begin feature setup.
2. Press **▼** until the screen display includes PHONE SETTINGS.
3. Press **ENTER**. The screen display includes EXTENSION NO.
4. Press **▼** until the screen display includes HOLD REMINDER and the current setting.
5. Press **◀** or **▶** to toggle between On and Off.
6. When the correct setting is shown, press **▼** to save your choice. The screen display includes MAIN MENU.
7. Press and hold **ENTER** to return to the idle screen.

NOTE: You can exit feature setup and return to the idle screen any time. Simply press and hold **ENTER**.

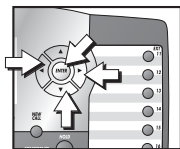

Set the time and date

1. Press **ENTER** to begin feature setup.
2. Press **▼** until the screen display includes TIME/DATE.
3. Press **ENTER**. The screen display includes HOUR and the current hour setting.
4. Press **◀** or **▶** until the correct hour is shown.
5. Press **▼** to save the hour setting. The screen display includes MINUTE and the current minute setting.
6. Press **◀** or **▶** until the correct minute is shown.
7. Press **▼** to save the minute setting. The screen display includes AM/PM and the current setting.
8. Press **◀** or **▶** to toggle between AM and PM.
9. Press **▼** to save the AM/PM setting. The screen display includes MONTH and the number of the current month setting.
10. Press **◀** or **▶** until the number of the correct month is shown.
11. Press **▼** to save the correct month setting. The screen display includes DATE and the current day of the month setting.
12. Press **◀** or **▶** until the correct day of the month is shown.
13. Press **▼** to save the day of the month. The screen display includes DAY OF WEEK and the current setting.
14. Press **◀** or **▶** until the correct day of the week is shown.
15. Press **▼** to save the time/date setting. The screen display includes MAIN MENU.
16. Press and hold **ENTER** to return to the idle screen.

NOTE: In setting the 29th day of February (which runs every four years), you can first set the month and day to either Jan 29 or Mar 29, DO NOT switch the date item, and then ONLY change the month to Feb. The LCD on the base unit will show Feb 29 after setting.

NOTE: You can exit feature setup and return to the idle screen any time. Simply press and hold **ENTER**.

Turn line usage on or off for each line

If you are not using all four phone lines at this extension, you need to turn off line usage for the unused lines. If you expand to a second, third or fourth line, turn line usage back on. Line 1 must be turned on for the intercom to work.

NOTE: You may use any combination of lines. Lines used do not need to be in order. For example, line usage can be turned on for lines 1 and 3 and turned off for lines 2 and 4.

You may also restrict the use of certain lines on this phone to intercom and paging only, by turning off line usage for each line you want restricted. When line usage is turned off, that line cannot be used to answer incoming calls or to make outgoing or transfer calls.

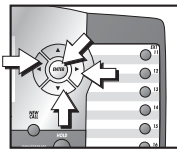

1. Press **ENTER** to begin feature setup.
 2. Press **▼** until the screen display includes **SPECIAL OPTIONS**.
 3. Press **ENTER**. The screen display includes **LINE USAGE**.
 4. Press **ENTER**. The screen display includes **L1 USAGE** and the current setting for this line.
 5. Press **◀** or **▶** to toggle between **On** and **Off** for the line shown.
 6. Press **▼** to save the current setting for this line and move to the next line with its current line usage setting.
 7. Repeat **steps 5 and 6** to set line usage for other lines at this extension.
 8. When you are finished setting line usage, press **▼** until the screen display includes **DONE**.
 9. Press **ENTER**. The screen display includes **LINE USAGE**.
 10. Proceed to **step 4** on page 34 to set up the next feature (prime line).
- OR—**
Press and hold **ENTER** to return to the idle screen.

NOTE: You can exit feature setup and return to the idle screen any time. Simply press and hold **ENTER**.

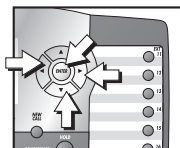

Assign the prime line (line preference)

1. Press **ENTER** to begin feature setup.
2. Press **▼** until the screen display includes SPECIAL OPTIONS.
3. Press **ENTER**. The screen display includes LINE USAGE.
4. Press **▼** until the screen display includes PRIME LINE and the current setting.
5. Press **◀** or **▶** to scroll through the line choices (Line 1 ... Line 4).
6. When the line you wish to set as prime is displayed, press **▼** to save your choice. The screen display includes AUTOMATIC MODE.
7. Proceed to **step 5** on page 35 to set the next feature (automatic mode).

—OR—

Press and hold **ENTER** to return to the idle screen.

NOTE: You can exit feature setup and return to the idle screen any time. Simply press and hold **ENTER**.

Set automatic mode

Choose the mode (headset or speakerphone) to be used automatically when you press a LINE button with the handset in the base unit.

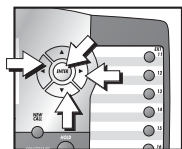

1. Press **ENTER** to begin feature setup.
2. Press **▼** until the screen display includes SPECIAL OPTIONS.
3. Press **ENTER**. The screen display includes LINE USAGE.
4. Press **▼** until the screen display includes AUTOMATIC MODE and the current setting.
5. Press **◀** or **▶** to toggle between Speakerphone and Headset.
6. When the desired mode is displayed, press **▼** to save your choice. The screen display includes SCROLL RATE.
7. Proceed to **step 5** on page 36 to set the next feature (scroll rate).

—OR—

Press and hold **ENTER** to return to the idle screen.

🎯 NOTE: You can exit feature setup and return to the idle screen any time. Simply press and hold **ENTER**.

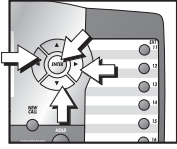

Set the scroll rate

You can choose the speed for the rapid scroll feature.
(See **Rapid scroll** on page 24 for details.)

1. Press **ENTER** to begin feature setup.
2. Press **▼** until the screen display includes **SPECIAL OPTIONS**.
3. Press **ENTER**. The screen display includes **LINE USAGE**.
4. Press **▼** until the screen display includes **SCROLL RATE** and the current setting.
5. Press **◀** or **▶** to change the setting (Very Slow, Slow, Medium, Fast, or Very Fast).
6. When the correct scroll rate is shown, press **▼** to save your choice. The screen display includes **LCD BACKLIGHT**.
7. Proceed to **step 5** on page 37 to set the next feature (LCD backlight).

—OR—

Press and hold **ENTER** to return to the idle screen.

NOTE: You can exit feature setup and return to the idle screen any time. Simply press and hold **ENTER**.

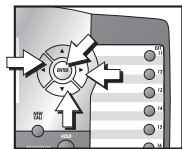

Turn screen backlight on or off

1. Press **ENTER** to begin feature setup.
2. Press **▼** until the screen display includes SPECIAL OPTIONS.
3. Press **ENTER**. The screen display includes LINE USAGE.
4. Press **▼** until the screen display includes LCD BACKLIGHT and the current setting.
5. Press **◀** or **▶** to toggle between On and Off.
6. When the correct setting is shown, press **▼** to save your choice. The screen display includes COVM ON/OFF.
7. Proceed to **step 5** on page 38 to set the next feature (COVM on/off).

—OR—

Press and hold **ENTER** to return to the idle screen.

NOTE: You can exit feature setup and return to the idle screen any time. Simply press and hold **ENTER**.

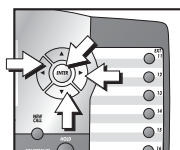

Turn COVM indicators on or off for each line

If you subscribe to voice mail service with your local telephone service provider, turn the COVM indicator on to have the screen display the appropriate line numbers when there are messages waiting. If you do not subscribe to voice mail service, turn the COVM indicators off for each line.

1. Press **ENTER** to begin feature setup.
2. Press **▼** until the screen display includes SPECIAL OPTIONS.
3. Press **ENTER**. The screen display includes LINE USAGE.
4. Press **▼** until the screen display includes COVM ON/OFF.
5. Press **ENTER**. The screen display includes L1 COVM ON/OFF and the current setting.
6. Press **◀** or **▶** to toggle between On and Off for the line shown.
7. When the correct setting is shown, press **▼** to save your choice. The screen display includes COVM ON/OFF for the next line and the current setting.
8. Repeat **steps 6 and 7** to turn the COVM indicator on or off for other lines at this extension.
9. When you are finished setting the COVM indicators, press **▼** until the screen display includes DONE.
10. Press **ENTER**. The screen display includes COVM ON/OFF.
11. Press **▼** until the screen display includes COVM RESET, then proceed to **step 5** on page 39 to clear the COVM indicators.

—OR—

Press and hold **ENTER** to return to the idle screen.

NOTE: You can exit feature setup and return to the idle screen any time. Simply press and hold **ENTER**.

Reset COVM indicator

If a COVM indicator remains on when there are no messages on that line, you may have received a false signal from your local telephone service provider. You can clear the indicator manually.

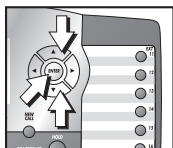

1. Press **ENTER** to begin feature setup.
2. Press **▼** until the screen display includes SPECIAL OPTIONS.
3. Press **ENTER**. The screen display includes LINE USAGE.
4. Press **▼** until the screen display includes COVM RESET.
5. Press **ENTER**. The screen display includes L1 COVM RESET.
6. Press **▲** or **▼** to scroll through the COVM Reset menu (L1 COVM RESET ... L4 COVM RESET, or ALL COVM RESET and DONE).
7. When the line you want to reset is displayed, press **ENTER** to remove the message waiting indicator. You can clear all the lines at once by choosing ALL COVM RESET. The screen display includes Reset!
8. Press **▼** until the screen display includes DONE.
9. Press **ENTER**. The screen display includes COVM RESET.
10. Press **▼** until the screen display includes AREA CODES, then proceed to **step 5** on page 40 to program the home or local area codes.

—OR—

Press and hold **ENTER** to return to the idle screen.

NOTE: You can exit feature setup and return to the idle screen any time. Simply press and hold **ENTER**.

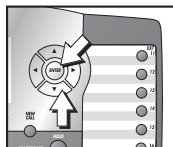

Program home and local area codes

You can program this phone to recognize one home and up to five local area codes. See **Home area code** and **Local area code** on page 6 for definitions.

1. Press **ENTER** to begin feature setup.
2. Press **▼** until the screen display includes **SPECIAL OPTIONS**.
3. Press **ENTER**. The screen display includes **LINE USAGE**.
4. Press **▼** until the screen display includes **AREA CODES**.
5. Press **ENTER**. The screen display includes **HOME AC** and the current setting.
6. Use the dial pad keys to enter your home area code, then press **▼**. The screen display includes **LOCAL AC1** and the current setting.

If you need to enter any local area codes, use the dial pad keys and then press **▼** to scroll to the next screen (**LOCAL AC2**, **LOCAL AC3**, **LOCAL AC4**, and **LOCAL AC5**).

NOTE: If you must dial the area code to place calls within your own area code, enter **000** for the home area code and enter your area code as a local area code.

7. When you are finished entering all of the area codes you need to program, press **▼** until the screen display includes **DONE**.
8. Press **ENTER**. The screen display includes **AREA CODES**.
9. Press **▼** until the screen display includes **LINE GROUP**, then proceed to **step 5** on page 41 to assign the line group.

—OR—

Press and hold **ENTER** to return to the idle screen.

NOTE: You can exit feature setup and return to the idle screen any time. Simply press and hold **ENTER**.

Assign the line group for this phone

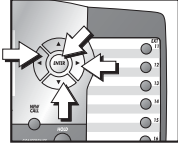

1. Press **ENTER** to begin feature setup.
 2. Press **▼** until the screen display includes **SPECIAL OPTIONS**.
 3. Press **ENTER**. The screen display includes **LINE USAGE**.
 4. Press **▼** until the screen display includes **LINE GROUP** and the current setting.
 5. Press **▶** or **◀** to scroll through the line group choices (Line 04 ... Line15, or PRV).
 6. When the line group you want is shown, press **▼** to save your choice. The screen display includes **RESET ALL**.
 7. Proceed to **step 5** on page 42 to reset all feature settings to default values.
- OR—**
- Press and hold **ENTER** to return to the idle screen.

NOTE: You can exit feature setup and return to the idle screen any time. Simply press and hold **ENTER**.

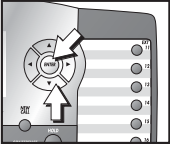

If you reset all features to the default settings, all previous feature programming and one touch entries will be erased. You will need to program your preferences for every feature again and re-enter numbers in one touch locations. You cannot undo the RESET ALL command.

1. Press **ENTER** to begin feature setup.
2. Press **▼** until the screen display includes SPECIAL OPTIONS.
3. Press **ENTER**. The screen display includes LINE USAGE.
4. Press **▼** until the screen display includes RESET ALL.
5. Press **ENTER**. The screen display includes ENTER:Reset all?
6. Press **ENTER** to confirm the command. The screen displays Reset! A tone sounds and the screen returns to showing RESET ALL.
7. Press and hold **ENTER** to return to the idle screen.

NOTE: You can exit feature setup and return to the idle screen any time. Simply press and hold **ENTER**.

Set answering system status

Turn the answering function on or off, or set this phone to be an auto-attendant for your multi-phone system.

Set answer status to **On** to activate the answering system in a single phone system. Set answer status to **Auto-Attendant** to activate the answering system and auto-attendant functions for a multi-phone system.

NOTE: The auto-attendant feature only works with a multi-phone system. If this phone is the only telephone in your system, do **NOT** select **Auto-Attendant** for the answer status.

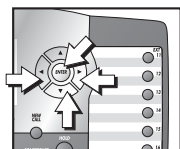

1. Press **ENTER** to begin feature setup.
2. Press **▼** until the screen display includes **DTAD/AA**.
3. Press **ENTER**. The screen display includes **ANSWER STATUS** and the current setting.
4. Press **◀** or **▶** to scroll through the choices (**On**, **Off**, or **AutoAttendant**). When the correct setting is shown, press **▼** to save your choice. The screen display includes **SINGLE PHONE**.
5. Proceed to **step 5** on page 44 to set the next feature (single phone).
—OR—
Press and hold **ENTER** to return to the idle screen.

NOTE: You can exit feature setup and return to the idle screen any time. Simply press and hold **ENTER**.

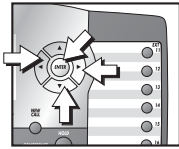

Set your phone for single phone operation



If this phone is the only telephone in your phone system (single phone), you **MUST** turn this feature on for the answering system to work. If you are using this phone as part of a multi-phone system, leave single phone off (default setting).

1. Press **ENTER** to begin feature setup.
2. Press **▼** until the screen display includes **DTAD/AA**.
3. Press **ENTER**. The screen display includes **ANSWER STATUS**.
4. Press **▼** until the screen display includes **SINGLE PHONE** and the current setting.
5. Press **◀** or **▶** to toggle between **Off** and **On**. When the correct setting is shown, press **▼** to save your choice. The screen display includes **ANSWER DELAY**.
6. Proceed to **step 5** on page 45 to set the next feature (answer delay).

—OR—

Press and hold **ENTER** to return to the idle screen.

⊙ NOTE: You can exit feature setup and return to the idle screen any time. Simply press and hold **ENTER**.

Set answer delay

Choose how long this phone rings before the answering system picks up a call. One ring is about six seconds.

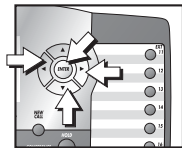

1. Press **ENTER** to begin feature setup.
2. Press **▼** until the screen display includes DTAD/AA.
3. Press **ENTER**. The screen display includes ANSWER STATUS.
4. Press **▼** until the screen display includes ANSWER DELAY and the current setting.
5. Press **◀** or **▶** to scroll through the choices (02 sec ... 60 sec). When the correct setting is shown, press **▼** to save your choice. The screen display includes AUTO ATT DELAY.
6. Proceed to **step 5** on page 46 to set the next feature (auto-attendant delay).

—OR—

Press and hold **ENTER** to return to the idle screen.

NOTE: You can exit feature setup and return to the idle screen any time. Simply press and hold **ENTER**.

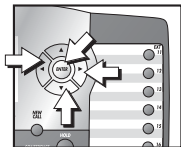

Set auto-attendant pickup delay

If this phone is a designated auto-attendant, you can choose how long the auto-attendant waits before picking up incoming calls. One ring is about six seconds.

1. Press **ENTER** to begin feature setup.
2. Press **▼** until the screen display includes DTAD/AA.
3. Press **ENTER**. The screen display includes ANSWER STATUS.
4. Press **▼** until the screen display includes AUTO ATT DELAY.
5. Press **◀** or **▶** to scroll through the choices (06 sec ... 30 sec). When the correct setting is shown, press **▼** to save your choice. The screen display includes DAY/NIGHT TIMES.
6. Proceed to **step 5** on page 47 to set the next feature (day and night times).

—OR—

Press and hold **ENTER** to return to the idle screen.

NOTE: You can exit feature setup and return to the idle screen any time. Simply press and hold **ENTER**.

Set auto-attendant day and night times



The auto-attendant feature only works with a multi-phone system. If you have more than one phone in your system, you **MUST** program the hours for day and night time so the answering system plays the correct outgoing announcement. Please see Answer system Auto-attendant operation beginning on page 110 for a detailed description of this feature.

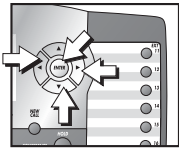

1. Press **ENTER** to begin feature setup.
2. Press **▼** until the screen display includes DTAD/AA.
3. Press **ENTER**. The screen display includes ANSWER STATUS.
4. Press **▼** until the screen display includes DAY/NIGHT TIMES.
5. Press **ENTER**. The screen display includes DAY TIME and the current setting.
6. Press **ENTER** to start to change the day time setting. The screen display includes HOUR and the current setting.

—OR—

Press **▼** and skip to **step 11** on page 48 to leave the day time setting as it is and begin to change the night time setting.

7. Press **◀** or **▶** until the correct day time hour is shown. Then, press **▼** to save the day time hour setting. The screen display includes MINUTE and the current setting.
8. Press **◀** or **▶** until the correct day time minute is shown. Then, press **▼** to save the day time minute setting. The screen display includes AM/PM and the current setting.

continued on page 48

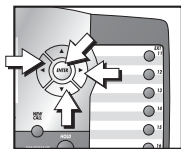

Set auto-attendant day and night times

continued from page 47

9. Press ◀ or ▶ to toggle between AM and PM. When the correct setting is shown, press ▼ to save the day time setting. The screen display includes DAY TIME and DONE.
10. Press **ENTER**. The screen display includes NIGHT TIME and the current setting.
11. Press **ENTER** to change the night time setting. The screen display includes HOUR and the current setting.
12. Press ◀ or ▶ until the correct night time hour is shown. Then, press ▼ to save the night time hour setting. The screen display includes MINUTE and the current setting.
13. Press ◀ or ▶ until the correct night time minute is shown. Then, press ▼ to save the night time minute setting. The screen display includes AM/PM and the current setting.
14. Press ◀ or ▶ to toggle between PM and AM. When the correct setting is shown, press ▼ to save the night time setting. The screen display includes NIGHT TIME and DONE.
15. Press ▼ until the screen display includes TOLL SAVER, then proceed to **step 5** on page 49 to set the toll saver.

—OR—

Press and hold **ENTER** to return to the idle screen.

NOTE: You can exit feature setup and return to the idle screen any time. Simply press and hold **ENTER**.

Turn toll saver on or off

When toll saver is turned on, the answering system picks up incoming calls within eight seconds if there is at least one new message. When there are no new messages, the answering system picks up the incoming call in the time you set as the answer delay (see **Set answer delay** on page 45 for details).

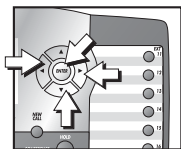

1. Press **ENTER** to begin feature setup.
2. Press **▼** until the screen display includes DTAD/AA.
3. Press **ENTER**. The screen display includes ANSWER STATUS.
4. Press **▼** until the screen displays includes TOLL SAVER and the current setting.
5. Press **◀** or **▶** to toggle between Off and On.
6. When the desired setting is shown, press **▼** to save your choice. The screen display includes REMOTE CODE.
7. Proceed to **step 5** on page 50 to set the next feature (remote code).

—OR—

Press and hold **ENTER** to return to the idle screen.

NOTE: You can exit feature setup and return to the idle screen any time. Simply press and hold **ENTER**.

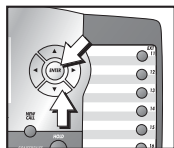

Program the remote code

You can change the remote code (password) used to access your phone remotely.

1. Press **ENTER** to begin feature setup.
2. Press **▼** until the screen display includes DTAD/AA.
3. Press **ENTER**. The screen display includes ANSWER STATUS.
4. Press **▼** until the screen display includes REMOTE CODE.
5. Press **ENTER**. The screen display includes REMOTE CODE and the current code.
6. Use the dial pad to enter a three-digit remote code, then press **▼** to save the new code. The screen display includes MESSAGE LENGTH.
7. Proceed to **step 5** on page 51 to set the next feature (message length).

—OR—

Press and hold **ENTER** to return to the idle screen.

NOTE: You can exit feature setup and return to the idle screen any time. Simply press and hold **ENTER**.

Set message length

You can select the maximum length for the messages callers can record when the answering function is on. If you choose *Unlimited*, the caller can record a message of any length, up to the amount of time remaining for all messages, memos and announcements. If you choose *Greeting Only*, the caller will hear the selected outgoing announcement but will not be able to record a message. If you choose *1 minute*, the caller can record a message up to one minute long.

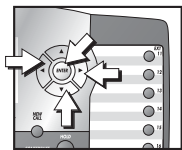

1. Press **ENTER** to begin feature setup.
2. Press **▼** until the screen display includes *DTAD/AA*.
3. Press **ENTER**. The screen display includes *ANSWER STATUS*.
4. Press **▼** until the screen display includes *MESSAGE LENGTH* and the current setting.
5. Press **◀** or **▶** to scroll through the choices (*Unlimited*, *1 minute*, or *Greeting Only*). When the desired message length is displayed, press **▼** to save your choice. The screen display includes *MESSAGE ALERT*.
6. Proceed to **step 5** on page 52 to set the next feature (audible message alert).
—OR—
 Press and hold **ENTER** to return to the idle screen.

NOTE: You can exit feature setup and return to the idle screen any time. Simply press and hold **ENTER**.

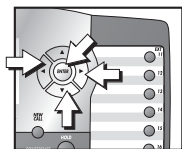

Turn audible message alert on or off

1. Press **ENTER** to begin feature setup.
2. Press **▼** until the screen display includes DTAD/AA.
3. Press **ENTER**. The screen display includes ANSWER STATUS.
4. Press **▼** until the screen display includes MESSAGE ALERT and the current setting.
5. Press **◀** or **▶** to toggle between Off and On. When the correct setting is shown, press **▼** to save your choice. The screen display includes MONITOR.
6. Proceed to **step 5** on page 53 to set the next feature (monitor).

—OR—

Press and hold **ENTER** to return to the idle screen.

NOTE: You can exit feature setup and return to the idle screen any time. Simply press and hold **ENTER**.

Turn monitor on or off

If you wish to hear incoming messages as they are recorded, turn the monitor feature on.

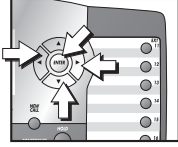

1. Press **ENTER** to begin feature setup.
 2. Press **▼** until the screen display includes DTAD/AA.
 3. Press **ENTER**. The screen display includes ANSWER STATUS.
 4. Press **▼** until the screen display includes MONITOR and the current setting.
 5. Press **◀** or **▶** to toggle between On and Off. When the correct setting is shown, press **▼** to save your choice. The screen display includes DTAD INTERCEPT.
 6. Proceed to **step 5** on page 54 to set the next feature (DTAD intercept).
- OR—**
- Press and hold **ENTER** to return to the idle screen.

NOTE: You can exit feature setup and return to the idle screen any time. Simply press and hold **ENTER**.

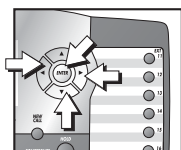

Turn DTAD intercept on or off

If you want other phones connected to line 1 on this extension to be able to pick up a call while the caller is recording a message, turn DTAD intercept on. For instructions to use this feature, see **Intercept an incoming message** on page 105.

1. Press **ENTER** to begin feature setup.
2. Press **▼** until the screen display includes DTAD/AA.
3. Press **ENTER**. The screen display includes ANSWER STATUS.
4. Press **▼** until the screen display includes DTAD INTERCEPT and the current setting.
5. Press **◀** or **▶** to toggle between Off and On. When the correct setting is shown, press **▼** to save your choice. The screen display includes MAIN MENU.
6. Press and hold **ENTER** to return to the idle screen.

NOTE: You can exit feature setup and return to the idle screen any time. Simply press and hold **ENTER**.

You will need to program the next two features if this phone is the designated console phone for your centrex system.

Set this phone to be the Centrex console phone

NOTE: This feature is for use with Centrex systems only.

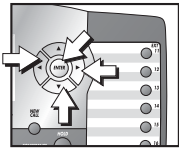

1. Press **ENTER** to begin feature setup.
2. Press **▼** until the screen display includes **CENTREX**.
3. Press **ENTER**. The screen display includes **CONSOLE** and the current setting.
4. Press **◀** or **▶** to toggle between On and Off.
5. Press **▼** to save your choice. The screen display includes **CSL DELAY RING**.
6. Proceed to **step 5 of Set the centrex console delayed ring time** on page 56 to change the next feature (console delayed ring).
—OR—
 Press and hold **ENTER** to return to the idle screen.

NOTE: You can exit feature setup and return to the idle screen any time. Simply press and hold **ENTER**.

Set the Centrex console delayed ring time

NOTE: This feature is for use with Centrex systems only.

Set the length of time the phone will route your calls to the Centrex console phone. One ring is about six seconds.

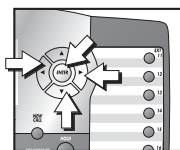

1. Press **ENTER** to begin feature setup.
2. Press **▼** until the screen display includes CENTREX.
3. Press **ENTER**. The screen display includes CONSOLE.
4. Press **▼** until the screen display includes DSL DELAY RING and the current setting.
5. Press **◀** or **▶** to scroll through the choices (Off, 02 sec ... 30 sec).
6. Press **▼** to save your choice. The screen display includes MAIN MENU.
7. Press and hold **ENTER** to return to the idle screen.

NOTE: You can exit feature setup and return to the idle screen any time. Simply press and hold **ENTER**.

Set the display language

1. Press **ENTER** to begin feature setup.
2. Press **▼** until the screen display includes LANGUAGE and the current setting.
3. Press **◀** or **▶** to scroll through the language choices (English, Español, or Français). When the language you want to use is displayed, press **▼** to save your choice. The screen display includes EXIT.
4. Press **ENTER** to return to the idle screen.

NOTE: You can exit feature setup and return to the idle screen any time. Simply press and hold **ENTER**.

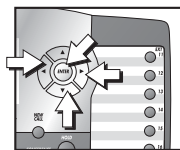

Telephone operation

NOTE: This phone comes programmed to use line 1 (default prime line) for calls if you do not press a LINE button. (To change the prime line, see **Assign the prime line** on page 34 of this manual.) When you answer a call, the phone automatically selects the ringing line.

Make or answer a call

NOTE: This phone will automatically make and answer calls in the mode (speakerphone or headset) you programmed (see **Set automatic mode** on page 35). Follow the directions below to choose a mode manually. If the phone is in use on one line, any other calls made or answered will use the same mode already in use.

NOTE: If you dial a phone number longer than 15 digits, the screen will display only the last 13 digits.



Handset

To make a call, lift the handset and dial the call.

To answer a call, lift the handset. Replace the handset to end the call.

To override automatic line selection, press the **LINE** button for the line you wish to select, then lift the handset.

continued on page 58

Make or answer a call

continued from page 57

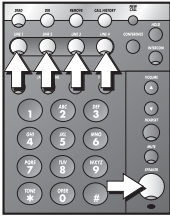
Speakerphone

To make a call, press and release the desired **LINE** button or **[SPEAKER]**. The **SPEAKER** light goes on. Wait for a dial tone, then dial the call. Press **[SPEAKER]** to end the call.

To answer a call, press **[SPEAKER]** or press the **LINE** button of the incoming call. Press **[SPEAKER]** again to end the call.

NOTE: If headset is programmed as the default mode (see **Set automatic mode** on page 35), you must press **[SPEAKER]** to activate the speakerphone.

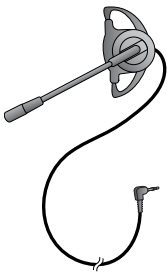
Headset

You can use this phone hands-free when you install any industry standard two-band 2.5mm headset or other compatible, electronically isolated headset. The headsets must be purchased separately. Headsets are available by calling Customer Service at **1 (800) 222-3111**. For best results, use an AT&T two-band 2.5mm headset.

Make sure the headset is plugged into the headset jack. You will hear a double-beep if you press **[HEADSET]** when the headset is not plugged in.

NOTE: If headset is programmed as the default mode, (see **Set automatic mode** on page 35) but the headset is not plugged in, the phone will switch to speakerphone.

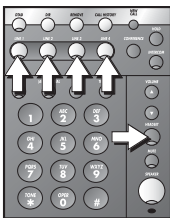

To make a call, press and release **[HEADSET]** or press the desired **LINE** button and then press **[HEADSET]**. The **HEADSET** light turns on. Wait for a dial tone, then dial the call. Press **[HEADSET]** to end the call.

To answer a call, press **[HEADSET]**. Press **[HEADSET]** again to end the call.

NOTE: If speakerphone is programmed as the default mode (See **Set automatic mode** on page 35), you must press **[HEADSET]** to activate the headset.

Switch between handset, headset and speakerphone

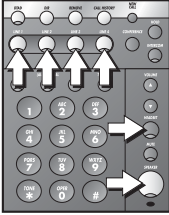

To switch from handset to headset or speakerphone, press **HEADSET** or **SPEAKER**, then replace the handset. (In order to use the headset, it must be plugged in.)

To switch from speakerphone to handset, lift the handset. (Do not press **SPEAKER** or the call will be disconnected.)

To switch from headset to handset when the handset is in the base unit, lift the handset.

To switch from headset to handset when the handset is off-hook, press **HEADSET** again.

To switch from headset to speakerphone, press **SPEAKER**.

To switch from speakerphone to headset, insert the headset plug into the jack, and press **HEADSET**.

To override automatic line selection, press and release a **LINE** button. This activates the speakerphone or headset, whichever is programmed as the default mode.

Timer

When you make or answer a call, the timer automatically starts. The screen displays the elapsed time in minutes and seconds for the first hour (up to 59:59) and then begins again. The timer stops automatically when you hang up and the recorded time is displayed for about 10 seconds. The timer also stops when you place a call on hold and resets to 00:00 when you release hold.

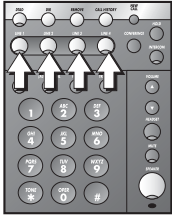

Call privacy

To ensure call privacy, this phone allows only one set at a time to use a line.

Cancel call privacy

During the call, press the **LINE** button for the call. You'll hear a short beep. Others can now join the call.

Restore call privacy

Press the **LINE** button again during the call. You'll hear a double-beep. The other phones will be dropped from the call.

NOTE: call privacy is automatically restored when you end the call.

NOTE: When a non-system phone answers a call, any other system phone can pick up the call by pressing the **LINE** button. Once a system phone picks up the call, call privacy is activated and no other system phones can listen to the call unless call privacy is canceled, but non-system phones which share that line can still join the call.

Do not disturb

When you activate do not disturb (DND), you will not hear paging tones, voice paging, or incoming call rings. Instead, the **LINE** light flashes and the **INTERCOM** light goes on to signal an incoming call or page. If you receive an intercom call, the **INTERCOM** light flashes, and the number of the intercom extension calling you appears on the display.



1. Press **DND** to prevent interruptions. The DND light goes on and the screen display includes **DND**.
2. Press **DND** again to resume normal call alerts. The DND light goes off and the screen no longer shows **DND**.

When this feature is activated, callers from within your phone system will hear long beeps.

Volume

Handset/speakerphone/headset volume control

When you are on a call, press **VOLUME** ▲ to increase call volume. Press **VOLUME** ▼ to decrease volume. You will hear a beep when you reach the minimum or maximum level.

Ringer volume

When the phone is ringing, press **VOLUME** ▲ or **VOLUME** ▼ to adjust the ringer volume. This phone has four ringer volume levels. As you adjust the ringer, you will hear the ring change.

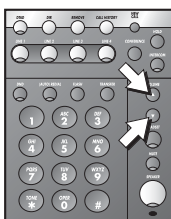

Turning ringer off

You may turn the ringer on or off for each line. For detailed instructions, see **Turn the ringer on or off for each line** on page 27.

Redial

The last number dialed from this extension (up to 32 digits) is stored in redial memory until you dial another number.

Handset

To dial the same number again, lift the handset, listen for the dial tone, then press **(AUTO) REDIAL**.

Speakerphone or headset

To dial the same number again, press a **LINE** button, then press **(AUTO) REDIAL**. The phone automatically dials the last number.

⊙ **NOTE:** You must go off hook (lift handset or press a **LINE** button for speakerphone or headset) before you press **(AUTO) REDIAL**. If you press **(AUTO) REDIAL** without going off hook, the screen displays the redial memory stack. (See **Redial stack** on page 62.)

⊙ **NOTE:** You will experience a one-second delay before the call is dialed when using the redial feature. This is normal.

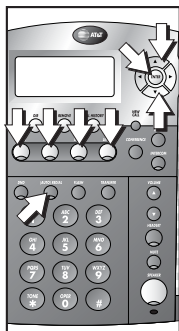

Redial stack

The last six numbers dialed from this extension are automatically stored in the redial memory stack. You can review the numbers in the redial memory and dial one if you wish.

1. When the phone is not on a call, press **[AUTO REDIAL]**.
2. Press **[▲]** or **[▼]** to scroll through the last six numbers dialed at this extension.
3. When the number you want to call is displayed, press **[ENTER]** or a **LINE** button. The call is dialed automatically using the mode (headset or speakerphone) you programmed as the automatic mode. (See **Set automatic mode** on page 35.)

NOTE: If you do not place a call within 30 seconds, the screen returns to idle.

Auto redial

This phone can automatically redial a number every 60 seconds up to ten times, or until the other line rings or you cancel auto redial. When the phone automatically redials the number, it always uses the line you originally used to dial the call.

- 1 Follow the instructions under **Redial stack** above to find the number you want to call.
- 2 Press a **LINE** button.
—OR—
Press **[ENTER]**. The phone will dial the call.
- 3 When the other line rings or the other party answers, lift the handset.
—OR—
Press **[SPEAKER]**.
—OR—
Press **[HEADSET]** and speak with the other party.

NOTE: You will hear a double-beep if you press **[HEADSET]** when the headset is not plugged in.

To cancel auto redial, press any button except **VOLUME [▲]** or **VOLUME [▼]**.

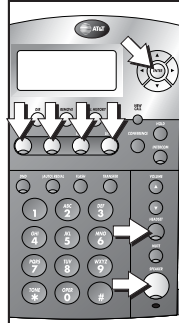



Hold

While on a call, press and release **HOLD**. The **LINE** light for the line on hold flashes slowly in green, and a double-beep sounds every 30 seconds to remind you the call is on hold. (To turn off the reminder beep, see **Turn hold reminder on or off** on page 31.) If you were using the handset, you can replace the handset in the base unit without disconnecting the call. If you were using the speakerphone, the speakerphone is automatically turned off when you press **HOLD**.

To release hold, press and release the **LINE** button of the call on hold.

NOTE: The phone automatically disconnects a call on hold after 20 minutes. To keep a call on hold longer than 20 minutes, release hold before 20 minutes and then place the call on hold again.

NOTE: You cannot put an intercom call on hold.

NOTE: If a line is in use, pressing **INTERCOM** will place the line on hold and activate the intercom.

Switch between lines

1. Press and release **HOLD** to keep a call on the first line.
2. Press and release the **LINE** button of another line to make or answer another call.

NOTE: If you switch lines without pressing **HOLD** first, you will drop the call.

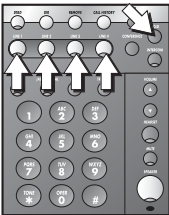



Mute

Mute allows you to hear the other party, but the other party can't hear you.

To activate this feature, press and release **[MUTE]**. The **MUTE** light goes on.

To return to the conversation, press and release **[MUTE]** again.

NOTE: Switching from handset to speakerphone or headset, or from speakerphone or headset to handset, changing lines, and putting a call on hold also cancel mute.

Flash

Use **[FLASH]** instead of the switchhook to activate telephone company subscriber services such as **call waiting** or **three-way calling**.



Temporary tone dialing

If you have dial pulse (rotary) service, you can change from dial pulse to touch tone dialing during a call by pressing **[XTONE]**.

1. Dial the number.
2. Press and release **[XTONE]**. Buttons pressed after this send touch tone signals.
3. After you hang up, the phone automatically returns to pulse service.

Conference calls

This feature lets you set up a three-party call by using two lines at the same time. You can also join an intercom call with a call on an outside line. The outside line call must be established first because an intercom call cannot be placed on hold.

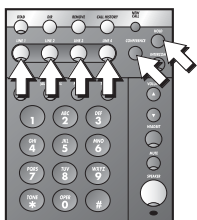

1. Make or answer a call.
2. Press and release **HOLD**.
3. Call someone on another line.
4. When this call is answered, press **CONFERENCE**. The three-party conference begins immediately.
5. To end a conference call, hang up. All parties will disconnect.

To talk privately with one party:

1. Press **HOLD** to place both lines on hold.
2. Press a **LINE** button to talk privately with the person on that line.
3. Press **CONFERENCE** to resume the conference call.

NOTE: An intercom call cannot be placed on hold. If one party is on the intercom, that party will be dropped from the call if you press **HOLD**.

To drop one line:

Press the **LINE** button of the party you want to keep. The other line will be dropped.

NOTE: Occasionally, the far-end parties on a conference call might not hear one another:

NOTE: If you are experiencing difficulty in using the conference features on this phone, please consider using AT&T's complete line of teleconference services to find a solution that best meets your needs. AT&T TeleConference Services reduces travel time and expense while increasing productivity wherever people are located allowing you to host truly virtual meetings and share important information in real time.. To sign up for AT&T TeleConference Services, go to: www.att.com/orderconference for details.

Transfer a call

You can transfer a call you answer to any other system phone. Once you transfer a call, it can be picked up at any other system phone, not just at the extension you called. For information about using the display screen menus, see Menu operation beginning on page 22.

NOTE: If a transferred call is not picked up within 20 minutes, the phone will automatically disconnect the call.

Blind transfer

While on a call:

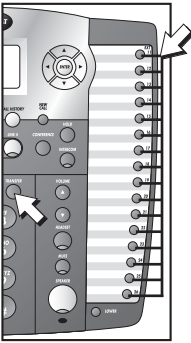

1. Press **TRANSFER**. The screen display is similar to:

This extension —

12:08 PM	12/26
EXT 11	
Transfer	

2. Press the **EXT** button for the extension where you're transferring the call.

—OR—

Dial the extension number where you're transferring the call. The screen display is similar to:

Extension called —

12:08 PM	12/26
EXT 11	
Transfer 12	

3. Hang up.

Your phone reminds you with a double-beep every 30 seconds when a transferred call has not been answered.

NOTE: If you do not dial an extension within 10 seconds, the transfer is automatically canceled.

Transfer a call and speak to the receiving party

While on a call:

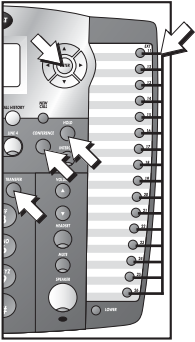

1. Press **HOLD**.
2. Press **INTERCOM**. The screen display is similar to:

This extension —

```

12:08 PM  12/26
EXT 11
INTERCOM TO_
PAGE
  
```

3. Press **ENTER**. The screen display is similar to:

```

12:08 PM  12/26
EXT 11
Paging
PAGE
  
```

4. Press the **EXT** button for the extension where you're transferring the call. The screen display is similar to:

Extension called —

```

12:08 PM  12/26
EXT 11
PAGE 12
  
```

When the other party answers, you can announce the call.

5. Press **TRANSFER**, then press the **EXT** button for the extension where you're transferring the call.
6. Hang up.

NOTE: If you do not dial an extension within 10 seconds, the transfer is automatically canceled.

Answer a transferred call

When you hear a long transfer ring, pick up the handset or press the **LINE** button of the call to use the speakerphone or headset.

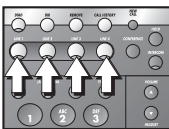

Low battery indicator

The screen displays **LOW BATT** when the battery needs to be replaced, or when no battery is installed.

Lights and what they mean

Light:	Status:	Means:
Line	On steadily, green	This line is in use at this extension.
	On steadily, red	This line is in use at another extension.
	Flashing slowly, green	This line is on hold at this extension.
	Flashing slowly, red	This line is on hold at another extension.
	Flashing quickly, green	This line is ringing. —OR— You are transferring a call from this extension.
	Triple flash, green	A call on this line is being transferred at another extension.
INTERCOM	Flashing slowly	The intercom is in use at another extension.
	Flashing quickly	You have an incoming intercom call.
	On steadily	You are on an intercom call.
MUTE	On	This phone is muted.
SPEAKER	On	You are on a speakerphone call.
	Flashing slowly	This phone is dialing an auto redial call.
HEADSET	On	You are on a headset call.
DND	On	Do not disturb is turned on.

Lights and what they mean

Light:	Status:	Means:
(AUTO)REDIAL	On steadily	The phone is waiting to redial an auto redial call.
	Flashing slowly	This phone is dialing an auto redial call.
DTAD	On steadily	Answering function is turned on.
	Flashing slowly	Answering function is turned on and you have new messages.
NEW CALL	On steadily	There is a new call in call history.
	Flashing slowly	There is a message waiting.

One touch operation

This telephone has 32 one touch locations where you can store phone numbers you wish to dial using fewer keys than usual. You can store up to 24 digits in each location. The steps used to dial numbers stored in one touch locations vary according to how you programmed the one touch preference. **See Set one touch preference** on page 25 and **Dial a one touch number** on page 74 for more details.

The first 16 locations can be accessed using only the EXT buttons. To access the remaining 16 locations, press **LOWER** and then the EXT button for the desired location.

NOTE: The EXT buttons are also used to place intercom calls. See Intercom operation beginning on page 83 for details.

You may wish to write the names or telephone numbers of one touch entries on the directory card, using the light gray spaces for the first 16 locations and the dark gray spaces for the second 16 locations.

One touch operation

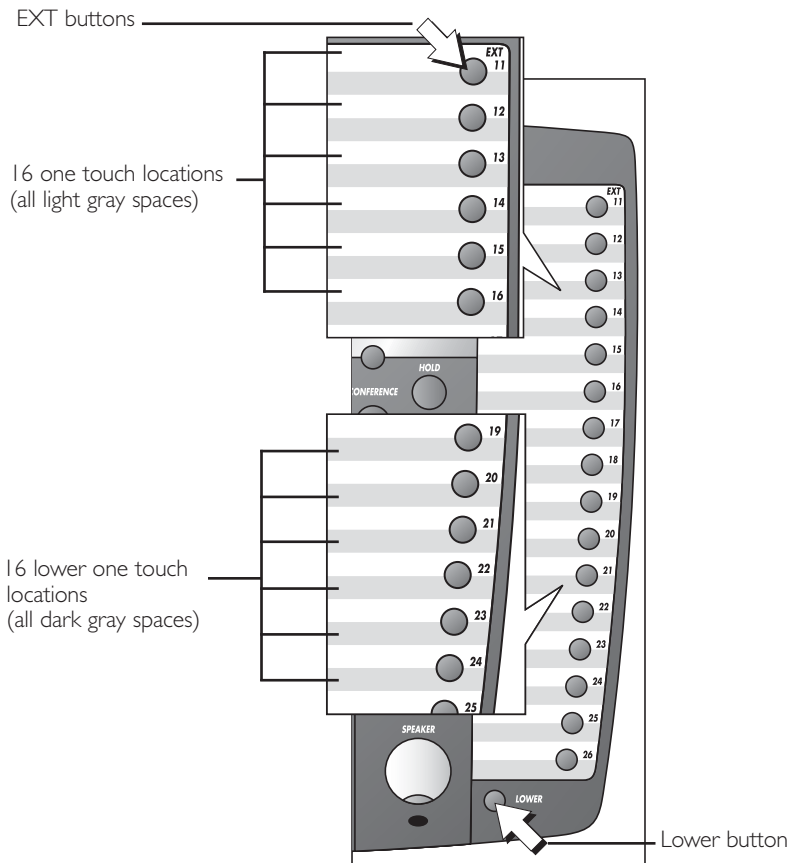

Store a number in a one touch location

For information about using the display screen menus, see Menu operation page 22.

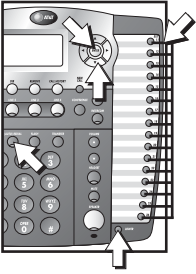

1. Press **ENTER** to enter the feature menu.
The screen displays ONE TOUCH.
2. Press **ENTER**. The screen display includes PREFERENCE and the current setting.
3. Press **▼** until the screen display includes PROGRAM.
4. Press **ENTER**. The screen display includes Enter Number.
5. Enter the phone number using the dial pad keys.
—OR—
Press **(AUTO) REDIAL** to copy the last number dialed from this extension to this location.
The screen will show the number as you enter it. You can press **◀** to backspace.
6. When you are finished entering the number, choose a one touch location:
Press the EXT button.
—OR—
Press **LOWER**, then press the EXT button.
The screen displays the number entered and Stored!

NOTE: Only the last number dialed from this extension can be copied to a one touch location. The other numbers in the redial stack cannot be copied.

NOTE: You can exit storing a number at any time. Press **▼** until the screen shows CANCEL, then press **ENTER**.
—OR—
Press and hold **ENTER**.

continued on page 72

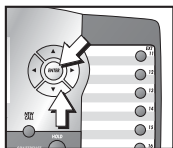

Store a number in a one touch location

continued from page 71

Store a pause in a one touch entry

You can include a pause while storing a dialing sequence which requires one during actual dialing.

While you are entering the number to be stored, the screen display includes **PAUSE**.

Press **ENTER** where you want to store a pause. Each pause counts as one digit. Continue storing the number as usual.

Store temporary touch tone signals in a one touch entry

If you have dial pulse (rotary) service, you can store a dialing sequence which includes the touch tone signals required for some special services.

While you are entering the number to be stored, the screen display includes **PAUSE**.

When you want to begin storing temporary tone signals, press **▼** until the screen display includes **TONE**, then press **ENTER**. All numbers you enter after this will send touch tone signals during dialing.

Store a flash in a one touch entry

You can store the flash signal required by some special services as part of a dialing sequence.

While you are entering the number to be stored, the screen display includes **PAUSE**.

When you want to enter a flash signal, press **▼** until the screen display includes **FLASH**, then press **ENTER**. Continue storing the number as usual.

Review a one touch entry

For more information about using the display screen menus, see Menu operation on page 22.

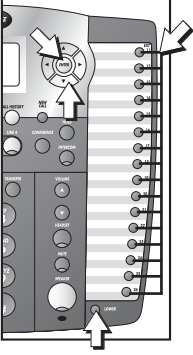

1. Press **ENTER** to enter the feature menu. The screen display includes ONE TOUCH.
2. Press **ENTER**. The screen display includes PREFERENCE.
3. Press **▼** until the screen display includes VIEW.
4. Press **ENTER**.
5. Press the EXT button.

—OR—

Press **LOWER**, then the EXT button for the entry you want to review.

The screen displays the number stored in that location. If there is no number stored in this location, the screen display includes <empty>.

6. Press and hold **ENTER** to return to the idle screen.

NOTE: You can exit one touch review at any time. Simply press and hold **ENTER**.

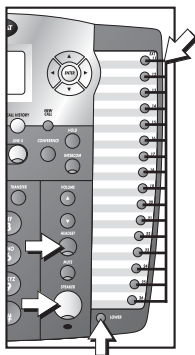

Dial a one touch number

This phone comes with One touch preference programmed to INTERCOM. These instructions apply only if you have not changed One touch preference.

NOTE: To change One touch preference, see **Set one touch preference** on page 25 of this manual.

If One touch preference is set to INTERCOM:

1. Lift the handset.
—OR—
Press **SPEAKER**.
—OR—
Press **HEADSET** and listen for the dial tone.
2. Press the EXT button.
—OR—
Press **LOWER**, then press the EXT button for the number you want to call.
The screen displays the number as it is dialed.

If One touch preference is set to TELEPHONE, you do not need to go off hook and listen for a dial tone before you dial a one touch number. You can simply:

1. Press the EXT button.
—OR—
Press **LOWER**, then press the EXT button for the number you want to call.
The screen displays the number as it is dialed using the speakerphone or headset as programmed for automatic mode. (See **Set automatic mode** on page 35.)

Directory operation

This 984 telephone can store up to 200 names and phone numbers in the directory. Names can be up to 16 characters long and numbers can be 24 digits long. Because directory entries are stored in alphabetical order, you may wish to enter names with the last name first in order to maintain consistency with the information stored automatically through the caller ID function of this system.

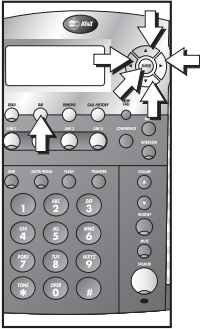

To enter directory mode, press **DIR**. The screen displays:

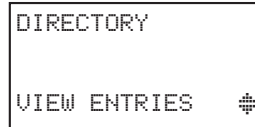

If there are already 200 stored entries, the screen display includes **DIRECTORY FULL!** If you try to view directory entries when there are no entries, the screen displays **no entries**.

To work with the directory, press **ENTER**. The screen will display menu choices on the bottom line.

To exit directory mode at any time, press **DIR**.

Menu structure

Use the navigation buttons (**◀**, **▶**, **▲**, **▼**, **ENTER**) to move through menu operations. See Menu operation on page 22 for information about moving through menus in the screen display.

The menu structure for the directory is shown below.

VIEW ENTRIES	ADD ENTRY
DIAL	ENTER NUMBER
EDIT NAME	DONE
DONE	PAUSE
CANCEL	PAUSE
EDIT NUMBER	FLASH
DONE	CANCEL
PAUSE	
TONE	
FLASH	
CANCEL	
MAIN MENU	

Store a name and number in the directory

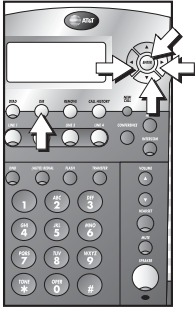

1. Press **DIR** to begin working with the directory.
2. Press **▼** until the screen display includes **ADD ENTRY**.
3. Press **ENTER**. The screen display includes **(Enter Name)**.
4. Use the dial pad keys and the chart below to enter the letters, digits or symbols you wish to store. Press the key repeatedly until the character you want is shown on the screen. For example, press **2** once for "A," twice for "B," three times for "C," and four times for "2." Press **▶** to move to the next character or space. Press **◀** to backspace. The name will appear on screen as you enter it.

PRESS:	ONCE	TWICE	3 TIMES	4 TIMES	5 TIMES	6 TIMES	7 TIMES	8 TIMES
1	,	-	'	&	.	()	!
2	A	B	C	2				
3	D	E	F	3				
4	G	H	I	4				
5	J	K	L	5				
6	M	N	O	6				
7	P	Q	R	S	7			
8	T	U	V	8				
9	W	X	Y	Z	9			
*	*							
0	0							
#	#							

5. When you are finished entering the name, press **ENTER** to move on to enter the phone number. The screen displays the name you entered and **(Enter Number)**.

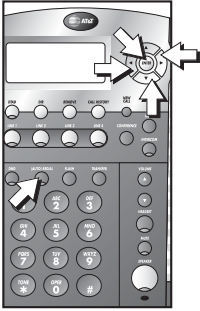

6. Use the dial pad keys to enter the phone number you wish to store.

—OR—

Press **(AUTO) REDIAL** to copy the last number dialed at this extension onto the screen.

Press **◀** to backspace. The number will appear on the second line of the screen as you enter it.

7. When you are finished entering the number, press **(ENTER)** to store the name and number in the directory. The screen briefly displays the name and number you stored and **Saved!** Then the screen will automatically return to include **ADD ENTRY**.

NOTE: You can exit the directory at any time without storing the entry, simply press **(DIR)**.

Store a pause in a directory number

You can include a pause in a number stored in the directory. When you reach the place in the dialing sequence where you wish to enter a pause, press **▼** until the screen displays:

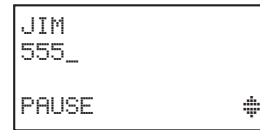

Press **(ENTER)** to store a two second pause. Then continue entering the number. Each pause counts as one digit.

continued on page 78

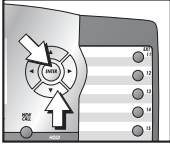

Store a name and number in the directory

continued from page 77

Store a temporary tone signal in a directory number

If you have dial pulse (rotary) service, you can store tone signals in a directory number. When you reach the place in the dialing sequence where you wish tone dialing to begin, press  until the screen displays:

```
JIM
555_
TONE 
```

Press **ENTER**. All digits entered after this will send tone signals.

Store a flash in a directory number

You can store the switchhook flash needed to access some custom-calling services in a directory number. When you reach the place in the dialing sequence where you wish to enter a flash, press  until the screen displays:

```
JIM
555_
FLASH 
```

Press **ENTER** to store the flash, then continue entering the number. Each flash counts as one digit.

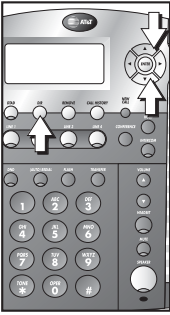

Review directory entries

1. Press **DIR** and then **ENTER** to begin working with the directory.
2. Press **▲** or **▼** to scroll through the directory entries.

—OR—

Press the dial pad key for the first character of the entry you wish to review until the character you are looking for is displayed. Then press **▲** or **▼** to scroll through the entries beginning with this character. If there is no entry for the character you chose, the screen will display `No Entries for "X"` (where X refers to the displayed character).

NOTE: You can exit the directory at any time without storing the entry; simply press **DIR**.

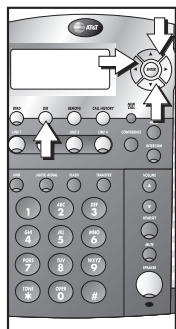

Edit a directory entry

1. Find the directory entry you wish to change by following the directions under **Review directory entries** on page 79.
2. When the entry you want to edit is displayed, press **ENTER**. The screen display includes DIAL.
3. Press **▼** until the screen display includes EDIT NAME.
4. Press **ENTER** and start to edit the name using the dial pad keys. (See the instructions in **step 4 of Store a name and number in the directory** on page 76 for details.)
5. When you are finished editing the name, press **▼** until the screen display includes DONE.
6. Press **ENTER** to save the new name in the directory. The screen display briefly includes Saved! The screen automatically returns to showing the new name you stored and the number.
7. Press **ENTER** and then press **▼** until the screen display includes EDIT NUMBER.
—OR—
Press **DIR** to save the new name and return to the idle screen without changing the number stored in this directory entry.
8. Press **ENTER** to begin editing the number using the dial pad keys. Press **◀** to backspace. The number will appear on the second line of the screen as you enter it.
9. Press **ENTER** to store the new number in the directory. The screen display briefly includes Saved! The screen automatically returns to showing the new name and number you stored.

NOTE: You can exit the directory at any time without storing the entry; simply press **DIR**.

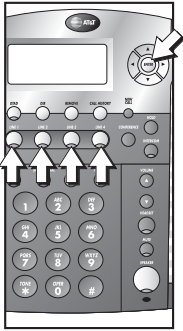

Dial a number from the directory

1. Find the entry for the number you wish to call by following the directions under **Review directory entries** on page 79.
2. Press **ENTER**. The screen display includes **DIAL**.
3. Press **ENTER**. The phone will automatically select an idle line and dial the call.

—OR—

Press the **LINE** button for the line you wish to use, then press **ENTER** to place the call.

The call will be dialed in the mode (speakerphone or headset) you programmed (see **Set automatic mode** on page 35).

Remove a name and number from the directory

1. Find the entry for the number you wish to call by following the directions under **Review directory entries** on page 79.
2. When the entry you wish to delete is displayed, press **REMOVE**. The screen display includes **Removed!** The screen automatically advances to the next directory entry.



NOTE: Once an entry is removed from the directory, it cannot be restored.

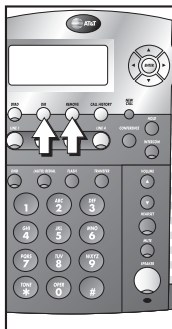

Remove all entries from the directory

1. Press **DIR** to begin working with the directory.
2. Press **REMOVE**. The screen display includes Remove all?
3. Press **REMOVE** again within three seconds to confirm the command and remove all directory entries. The screen briefly displays Removing ... and then All Removed!

The screen automatically returns to:

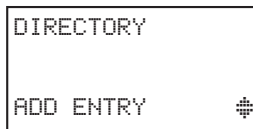



NOTE: Once the entries are removed from the directory, they cannot be restored.

Intercom operation

This 984 telephone is fully compatible with any AT&T Four-Line Small Business System Speakerphone 945 or 974 units you may have installed. You can use a total of 16 945/974/984 units together as extensions in your phone system.

This 984 telephone is also compatible with any AT&T 964/955/944 phones you have previously installed. This 984 telephone is **NOT** compatible with any 843, 853, 854, 874, or 954 telephones you may have previously installed.

 **NOTE:** If you have one or more 964, 955, or 944 phone(s) installed in the same phone system with this 984 telephone, you can only have 12 extensions in the phone system.

 Each individual phone in your telephone system **MUST** be assigned a unique extension number for the intercom feature to work. See **Assign an extension number to your phone** on page 26 for instructions.

 **NOTE:** If you subscribe to DSL service, please read **DSL users** beginning on page 4 for information about minimizing problems with this phone caused by DSL signals.

This intercom features both a single-phone page and a system-wide page. A single-phone page alerts only one phone. A system-wide page alerts all system phones. Any phone with the Do not disturb (DND) feature activated will not receive a page.

An intercom call rings at the extension called with a repeating double-ring pattern.

A single-phone page automatically activates the speakerphone on the receiving phone. You can deactivate the speakerphone by lifting the handset.

 **NOTE:** If a line is in use, pressing **INTERCOM** will place the line on hold and activate the intercom.

Basic intercom operations

Operation:	Function:
INTERCOM	Any two extensions connected to line 1 can ring each other.
PAGE	Lets you announce over the speaker of the phone you're calling. The person you've called can respond just by talking.
PAGE ALL	Lets you announce to all phones in the system at the same time (system-wide page).
CONFERENCE	Lets you connect another intercom call with an outside line.

Make an intercom call with the handset

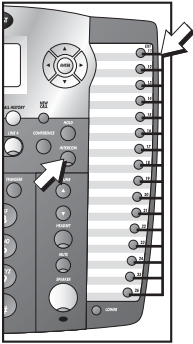

1. If One touch preference is set to INTERCOM, skip to **step 2**.
—OR—
If One touch preference is set to TELEPHONE, press **INTERCOM**.
2. Press the EXT button for the party you wish to call, then lift the handset. The screen display is similar to:

Extension called

12:08 PM	12/26
INTERCOM TO 15	

If the extension you called is idle or set to Do not disturb, you will hear long beeps. If the other extension is on a call, you will hear a busy signal.

- NOTE:** The intercom call is automatically canceled if you do not press an EXT button within 10 seconds.
- NOTE:** When you direct an intercom call to one extension, any extension in the system can answer the call by pressing **INTERCOM**.

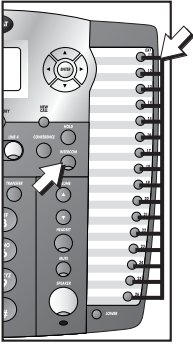

Make an intercom call with the speakerphone or headset

With the handset in the base unit:

1. If One touch preference is set to **INTERCOM**, skip to **step 2**.

—OR—

If One touch preference is set to **TELEPHONE**, press **[INTERCOM]**. The phone will automatically activate the line in the mode (headset or speakerphone) you programmed (see **Set automatic mode** on page 35).

2. Press the EXT button of the party you wish to reach. The screen display is similar to:

Extension called 12:08 PM 12/26
INTERCOM TO 15

If the extension you called is idle or set to Do not disturb, you will hear long beeps. If the other extension is busy, you will hear a busy signal.

NOTE: The intercom call is automatically canceled if you do not press an EXT button within 10 seconds.

NOTE: When you direct an intercom call to one extension, any extension in the system can answer the call by pressing **[INTERCOM]**.

Answer an intercom call

NOTE: An intercom call can be answered at any extension in the phone system by pressing **INTERCOM**.

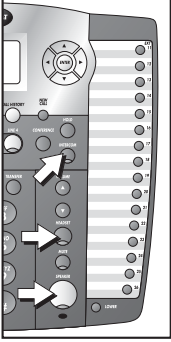

When you receive an intercom call, you will hear a repeating double-ring pattern and your screen displays **INTERCOM FROM** with the extension number of the caller. Answer the intercom call by lifting the handset, or by pressing **INTERCOM**, **SPEAKER** or **HEADSET** to take the call hands-free.

NOTE: If you press **INTERCOM** to answer the call, the phone will automatically use the mode (speakerphone or headset) you programmed as the automatic mode (see **Set automatic mode** on page 35).

End an intercom or page call

To end the intercom or page call, press **INTERCOM**.

—OR—

Hang up or press **SPEAKER** or **HEADSET** again.

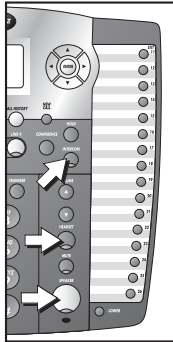

Page a specific extension (single-phone page)

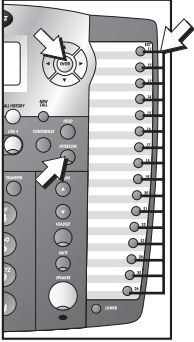

1. Press **INTERCOM**. The screen display is similar to:

This extension

```
12:08 PM 12/26
EXT 11
INTERCOM TO_
PAGE #
```

2. Press **ENTER**. The screen display is similar to:

```
12:08 PM 12/26
EXT 11
Paging
PAGE
```

3. Press the **EXT** button for the party you wish to page. The screen display is similar to:

Extension paged

```
12:08 PM 12/26
EXT 11
PAGE 15
```

Answer a single-phone page

Auto-mute off

When your extension receives a page, the phone beeps and the speakerphone is automatically activated. Answer the call by simply speaking.

If you are on the headset, you can answer the page by pressing **HEADSET** and speaking through the headset.

Auto-mute on

The **MUTE** light will be on. Lift the handset or press **MUTE** to temporarily deactivate auto-mute and answer the page.

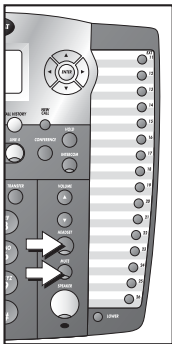

Page all system phones

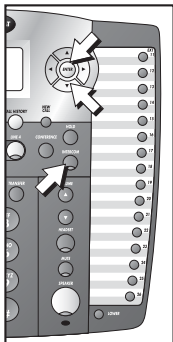

1. Press **INTERCOM**. The screen display is similar to:

```
12:08 PM 12/26
EXT 11
INTERCOM TO_
PAGE
```

2. Press **▼** until the screen display is similar to:

```
12:08 PM 12/26
EXT 11
INTERCOM TO_
PAGE ALL
```

3. Press **ENTER**. The screen display is similar to:

```
12:08 PM 12/26
EXT 11
PAGE ALL
```

Once the page is automatically answered at another extension, speak and your voice will be heard at all idle extensions in your phone system.

Answer a system-wide page

NOTE: Only one extension can answer a system-wide page.

When you receive a system-wide page, your phone beeps and the screen shows the paging extension with a display similar to:

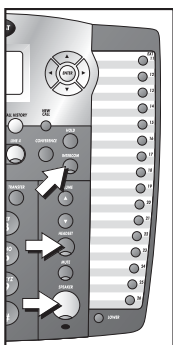

```
12:08 PM 12/26
PAGE ALL FROM 12
```

1. Press **INTERCOM** to answer the page. The screen display is similar to:

```
12:08 PM 12/26
INTERCOM FROM 12
```

2. To end, press and release **SPEAKER** or **HEADSET**.

Make an intercom conference call

A system phone on a two-way conversation on an outside line can invite a third party at an intercom extension into the conversation. Follow the directions under **Conference calls** on page 65, making sure to establish the non-intercom call first.

NOTE: You cannot put an intercom conference call on hold.

Room monitor

You can activate the speaker of another phone to monitor sounds in that room. The auto-mute feature must be turned off at the phone you want to monitor. (See **Turn auto-mute on or off** on page 30 for instructions.)

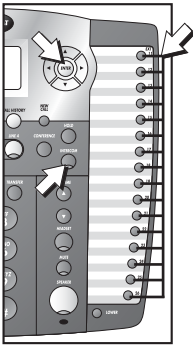

1. Press **INTERCOM**. The screen display is similar to:

```
12:08 PM  12/26
EXT 11
INTERCOM TO_
PAGE
```

2. Press **ENTER**. The screen display is similar to:

```
12:08 PM  12/26
EXT 11
Paging
PAGE
```

3. Press the **EXT** button for the telephone you want to monitor. The screen display is similar to:

```
12:08 PM  12/26
EXT 11
PAGE 15
```

The party at the extension being monitored will hear the intercom ring as with any page call, signaling that the speakerphone has been activated.

Caller ID operation

This telephone has a Caller ID feature that works with caller identification service provided by your local telephone company. There is a fee for this service, and it may not be available in all areas. This phone can provide information only if both you and the caller are in areas offering caller identification service, and if both telephone companies use compatible equipment.

When you use this phone with caller ID service, you can see who's calling before you answer the phone. If you subscribe to caller ID with call waiting, a **combined** service available through many local telephone companies, you can see who's trying to reach you even when you're on another call. This service may be called by different names (such as caller ID with visual call waiting) by different local telephone companies and may not be available in all areas.

 **NOTE:** You must subscribe to combined caller ID with call waiting as a single service to see caller ID information for a call waiting call. Check with your telephone company for its availability.

This phone assigns each incoming call a number from 1 to 200. The most recent call will have the highest number. (For example, if two calls have been received, call number 002 is the most recent.) When the call history is full, the earliest call information is automatically deleted to make room for new incoming call information.

The format of phone numbers displayed will depend on the home and local area codes you programmed. (See **Home area code** and **Local area code** on page 6 for explanations of area codes. See **Program home and local area codes** on page 40 for programming instructions.) If the call came from within your home area code, the screen displays only the seven digit number (without an area code). If the call came from one of your local area codes, the screen displays 10 digits (area code plus the seven-digit number). If the call did not come from any of the area codes you programmed, (1) phone numbers with 10 or more digits will automatically have a 1 inserted and displayed before the number and, (2) phone numbers with fewer than 10 digits will be displayed without a 1.

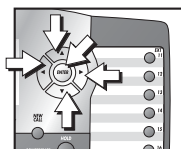

Menu structure

Use the navigation buttons (◀, ▶, ▲, ▼, **ENTER**) to move through menu operations. See Menu operation on page 22 for information about moving through menus in the screen display. The menu structure for call history is shown below.

DIAL
COPY TO DIR
COPY TO 1-TOUCH

Caller ID display

When you receive incoming caller ID information, the screen display is similar to:

```
12:08PM 12/26 L2
JOHN SMITH
5550123
```

The time and date of the call, the caller's name and phone number are included in the display if sent by the caller's telephone company. The incoming line number of the call also appears on screen (L2 in the above example). Other messages may appear on screen. See **Display screen messages** on page 94 for more information.

Caller ID information will appear on the screen as long as the phone rings or until the caller hangs up, or when the call is answered at another extension in your phone system, or when another extension which answered the call hangs up.

If you subscribe to caller ID service, this phone automatically resets the time and date each time new call information is received. You can set the time and date yourself if you wish. (See **Set the time and date** on page 32.)



Call waiting

If you subscribe to caller ID with call waiting service and you receive a call waiting call, the screen displays call information for the call similar to:

```
L2 (Call Waiting)
JOHN SMITH
5550123
```

1. Press **FLASH** to access the call waiting call.
2. To switch back to the original call, press **FLASH** again.

Calls received on two or more lines simultaneously

Your screen can display the caller ID information for only one call at a time, but you can switch between the information for two or more ringing lines by pressing **◀** or **▶**.

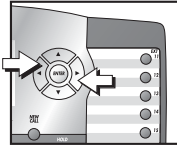

For example, if Line 3 of the phone is ringing, the screen displays the caller ID information for Line 3:

```
12:08PM 12/26 L3
JOHN SMITH
5551234
```

If the phone begins to ring on Line 1, the screen will display the new caller's information after it is received:

```
12:08PM 12/26 L1
MARY BROWN
5550127
```

Press **◀** or **▶** to review the caller ID information for the first call and the screen displays:

```
12:08PM 12/26 L3
JOHN SMITH
5551234
```

Pressing **◀** or **▶** repeatedly will allow you to switch between all of the incoming call information. See **Display screen messages** on page 94 for information about other possible messages.

Display screen messages

Display:	Means:
PRIVATE NAME	The other party is blocking name information.
PRIVATE NUMBER	The other party is blocking telephone number information.
UNKNOWN NAME	Your phone company is unable to receive information about this caller's name.
UNKNOWN NUMBER	Your phone company is unable to receive information about this caller's number.
OUT OF AREA	The call information is unavailable.

Message waiting and NEW CALL light

This light stays on when you have received call information but have not yet reviewed it. If you subscribe to a voice mail service, this light flashes when you have unretrieved messages waiting. The screen also displays information about the number of new calls and voice mail messages waiting.

```
12:08PM 12/26
EXT 22
CID:100/198 COVM
1 34
```

CID:100/198 Indicates 100 **new** caller ID messages and 198 **total** caller ID messages.

COVM There is voice mail "message waiting" information on lines 1, 3 and 4.
1 34

NOTE: You have to set COVM on to receive notification of "message waiting".

Call history

View call history summary

1. Press **CALL HISTORY**. The screen displays the numbers of total calls and new calls in call history:

```
CALL HISTORY
198 CALLS
115 NEW
```

2. Press **CALL HISTORY** again to exit call history mode.

continued on page 96

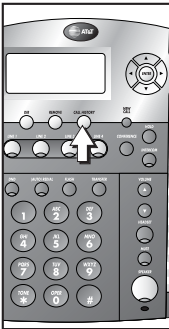

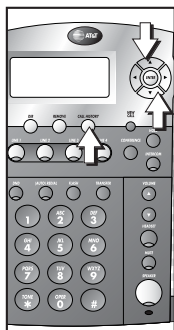

Call history

continued from page 95

Review records in call history

1. Press **CALL HISTORY**. The screen displays the numbers of total calls and new calls in call history:

```
CALL HISTORY
198 CALLS
115 NEW
```

2. Press **▼** to view the previous (most recent) caller's information.

—OR—

Press **▲** to view the earliest caller's information.

The screen displays the caller information:

```
10:27AM 11/12 L3
JOHN SMITH
5550123
CL#001 NEW
```

10:27AM 11/12	Time and date of the call
L3	The call came in on line 3
JOHN SMITH	Caller's name
5550123	Caller's phone number
CL#001	This is the first (earliest) record in call history
NEW	This is new, previously unreviewed call information

See **Display screen messages** on page 94 for information about other possible messages.

NOTE: To exit call history at any time without saving changes, press **CALL HISTORY**.

Remove calls from call history

Remove a specific call record from call history



1. Locate the call record you wish to delete following the instructions under **Review records in call history** on page 96.

2. Press **REMOVE**. The screen display includes Removed!

Then the screen displays the previous record in call history. If there are no records in call history, the screen displays:

```
CALL HISTORY
000 CALLS
000 NEW
```

Remove all calls from call history

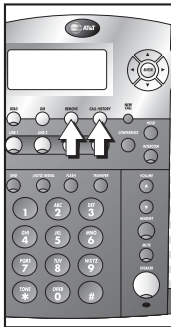

1. Press **CALL HISTORY**. The screen displays the numbers of total calls and new calls in call history.
2. Press **REMOVE**. The screen display includes Remove all?
3. Press **REMOVE** again within three seconds to confirm the command and delete all records from call history. The screen display includes Removing... and then ALL Removed!
The screen automatically returns to the call history summary.

NOTE: To exit call history at any time without saving changes, press **CALL HISTORY**.

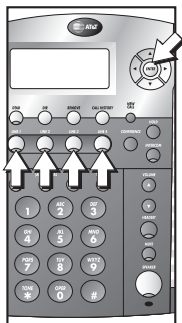

Dial a number from call history

As you review call history records, you can dial a displayed phone number.

1. Locate the number you wish to call in call history (see **Review records in call history** on page 96). The screen display is similar to:

```
10:27AM 11/12 L3
JOHN SMITH
5550123
CL#001 NEW
```

2. Press **ENTER**. The screen display includes DIAL.
3. Press **ENTER**. The phone will automatically select an idle line and dial the call.

—OR—

Press the **LINE** button for the line you wish to use.

The call will be dialed in the mode (speakerphone or headset) you programmed (see **Set automatic mode** on page 35).

Save a name and number from call history to the directory

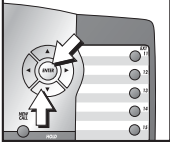

1. Locate the call history record number you wish to save (see **Review records in call history** on page 96). The screen display is similar to:

```
10:27AM 11/12 L3
JOHN SMITH
5550123
CL#001 NEW
```

- NOTE:** If a call history record does not include a phone number, it cannot be saved to the directory.
2. Press **ENTER**. The screen display includes DIAL.
 3. Press **▼** until the screen display includes COPY TO DIR.
 4. Press **ENTER** to save the name and number to the directory. The screen displays the name, number and added to DIR! The screen automatically returns to the call record just reviewed.
- NOTE:** To exit call history at any time without saving changes, press **CALL HISTORY**.

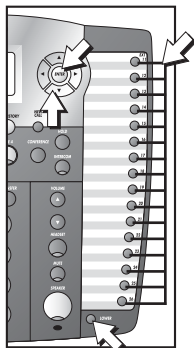

Save a number from call history to a one touch location

1. Locate the call history record you wish to save (see **Review records in call history** on page 96). The screen display is similar to:

```
10:27AM 11/12 L3
JOHN SMITH
5550123
CL#001 NEW
```

NOTE: If a call history record does not include a phone number, it cannot be saved to the directory.

2. Press **ENTER**. The screen display includes DIAL.
3. Press **▼** until the screen display includes COPY TO 1-TOUCH.
4. Press **ENTER** to begin to save the number. The screen display includes Press 1-TOUCH.
5. Press the EXT button where you want to save the number.

—OR—

Press **LOWER**, then press the EXT button. The screen displays the number and saved to 1-TOUCH.

The screen automatically returns to the call record just reviewed.

NOTE: To exit call history at any time without saving changes, press **CALL HISTORY**.

Answering system DTAD operation

The answering system can store approximately 20 minutes of messages, memos and announcements, for up to 99 messages in total.

Turn answering system on or off

The answering function of this phone is programmable. See **Set answering system status** on page 43 of Feature setup for programming instructions.

Enter DTAD mode

Press **DTAD** to access answering system features whether the answering function is turned on or off. The screen display is similar to:

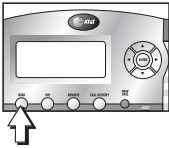

```
DTAD
21 Messages
PLAY NEW MSGS
```

If DTAD memory is full and the system cannot store additional messages, the screen display is similar to:

```
DTAD FULL!
21 Messages
PLAY NEW MSGS
```

When the answering system is on and there are new messages, the DTAD light flashes.

When the answering system is active (programming, message playback or taking a call), the dial pad keys are disabled.

To exit DTAD and return to idle screen, press **DTAD**.

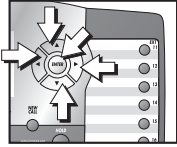

Menu structure

Use the navigation buttons (◀, ▶, ▲, ▼, **ENTER**) to move through menu operations. See Menu operation on page 22 for information about moving through menus in the screen display. The menu structure for DTAD operation is shown below.

- PLAY NEW MSGS
- PLAY ALL MSGS
- RECORD CALL
- RECORD MEMO
- OGM PLAY&RECORD
- ANS-OGM
- AA Day-OGM
- AA Night-OGM
- AA Aux-OGM
 - PLAY
 - RECORD
 - EXIT
- REMOVE ALL MSGS

Record an outgoing announcement

NOTE: If you choose not to record an outgoing announcement, the answering system plays a pre-recorded announcement. The pre-recorded announcement for **ANS-OGM** is, "Hello, please leave your message after the tone." The pre-recorded auto attendant outgoing announcements are described in the Answering system Auto-attendant operation section of this manual, beginning on page 110.

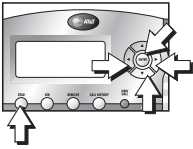

1. Press **DTAD** to access the answering system.
2. Press **▼** until the screen display includes **OGM PLAY&RECORD**.
3. Press **ENTER**. The screen display includes **PLAY** and the current announcement setting.
4. Press **◀** or **▶** to choose the outgoing announcement you want to record (**ANS-OGM**, **AA Day-OGM**, **AA Night-OGM**, or **AA Aux-OGM**).
5. When the desired announcement is shown, press **▼** until the screen display includes **RECORD** and the selected announcement.
6. Press **ENTER**. After the system beeps, speak toward the phone in a normal tone of voice without any background noise. While you are recording, the screen display includes **Recording** and the selected announcement.
7. To stop recording, press **ENTER**. The system automatically plays back your announcement.

NOTE: To exit **DTAD** and return to the idle screen at any time, press **DTAD**.

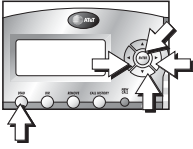

Review an outgoing announcement

1. Press **[DTAD]** to access the answering system.
 2. Press **[▼]** until the screen display includes OGM PLAY&RECORD.
 3. Press **[ENTER]**. The screen display includes PLAY and the current announcement setting.
 4. Press **[◀]** or **[▶]** to choose the outgoing announcement you want to review (ANS-OGM, AA Day-OGM, AA Night-OGM, or AA Aux-OGM).
 5. When the desired announcement is shown, press **[ENTER]**. The announcement starts to play and the screen display includes Playing and the selected announcement.
 6. Press **[ENTER]** to stop playback. The screen display includes PLAY.
 7. Repeat **steps 4-6** to review another outgoing announcement.
- OR—**
- Press **[DTAD]** to exit and return to the idle screen.

🎯 NOTE: To exit DTAD and return to the idle screen at any time, press **[DTAD]**.

Remove an outgoing announcement

NOTE: When you erase your announcement, the system returns to the pre-recorded announcement until you record a new one.

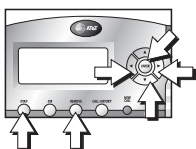

1. Press **DTAD** to access the answering system.
2. Press **▼** until the screen display includes OGM PLAY&RECORD.
3. Press **ENTER**. The screen display includes PLAY and the current announcement setting.
4. Press **◀** or **▶** to choose the outgoing announcement you want to record (ANS-OGM, AA Day-OGM, AA Night-OGM, or AA Aux-OGM).
5. When the desired announcement is shown, press **ENTER**. The announcement starts to play and the screen display includes Playing and the selected announcement.
6. While the outgoing announcement plays, press **REMOVE** twice to erase the announcement.

NOTE: To exit DTAD and return to the idle screen at any time, press **DTAD**.

Monitor incoming calls

When a caller is recording an incoming message, you can hear it through the speaker if you have programmed the monitor to be on (see **Turn monitor on or off** on page 53).

Intercept an incoming message

If DTAD intercept is turned on (see **Turn DTAD intercept on or off** on page 54), you can pick up a call while the caller is recording a message. You must use a phone connected to the same incoming line as the caller is using. At a system phone, answer the call as usual. To answer the call at a non-system phone, press **#1**. The DTAD stops recording when you pick up the call.

Listen to your messages

The idle screen displays the numbers of total and new messages on the answering system. For example, this screen display indicates that you have 11 new and a total of 21 messages stored on the answering system.

```
12:08PM 12/26
EXT22

DTAD: 11/21
```

Play new messages

1. Press **[DTAD]**. The screen display includes PLAY NEW MSGS.
2. Press **[ENTER]**. The answering system plays back only new messages in the order they were received. The DTAD announces the time and date each message was received. The screen shows the number of the current message during playback.
3. Press **[ENTER]** at any time to stop message playback. The screen display includes PLAY and the current message number.
4. Press **[ENTER]** to resume message playback.

—OR—

Press **[▼]** until the screen display includes EXIT MSG PLAY.

Then, press **[ENTER]** to exit message playback.

The screen returns to:

```
DTAD

21 Messages
PLAY NEW MSGS
```

Play all messages

1. Press **[DTAD]**. The screen display includes PLAY NEW MSGS.
2. Press **[▼]** until the screen display includes PLAY ALL MSGS.

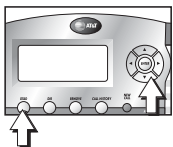
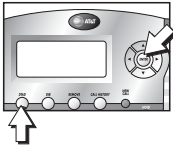

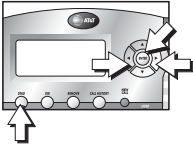

3. Press **[ENTER]**. The answering system plays back all messages in the order they were received. The DTAD announces the time and date each message was received. The screen shows the number of the current message during playback.
4. Press **[ENTER]** at any time to stop message playback. The screen display includes **PLAY** and the current message number.
5. Press **[ENTER]** to resume message playback.

—OR—

Press **[▼]** until the screen display includes **EXIT MSG PLAY**. Then, press **[ENTER]** to exit message playback. The screen returns to:

```
DTAD
21 Messages
PLAY ALL MSGS
```

Repeat a message

During message playback, press **[◀]** to return to the previous message. The screen displays the current message number so you can see which message you've chosen. After you press **[◀]**, the DTAD plays only the previous message and message playback ends.

Skip to next message

During message playback, press **[▶]** to skip to the next message. The screen displays the current message number so you can see which message you've chosen. After you press **[▶]**, the DTAD plays only the next message and message playback ends.

Save messages

The DTAD automatically saves your messages until you remove them. The answering system can store approximately 20 minutes of messages, memos and announcements, for up to 99 messages in total. If DTAD memory is full and the answering system cannot store additional messages, the screen display includes **DTAD FULL!** You need to remove messages to make room for new ones.

⊙ NOTE: To exit DTAD and return to the idle screen at any time, press **[DTAD]**.

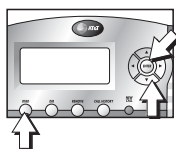

Remove messages

Remove a selected message

You can remove a message while listening to it. Press **REMOVE** while the message you want to erase is playing. The screen display includes **Removed!** and the message number you erased.

The answering system immediately plays the next message.

Remove all messages

1. Press **DTAD** to access the answering system.
2. Press **▼** until the screen display includes **REMOVE ALL MSGS.**
3. Press **ENTER**. The screen display includes **Remove all?**
4. Press **ENTER** again within three seconds to confirm the command. The screen displays **All Removed!** briefly and then changes to display **RECORD MEMO.**

NOTE: If you try to remove all messages when you have new (unreviewed) messages, you will hear an error tone. The DTAD will not remove any messages.

NOTE: To exit DTAD and return to the idle screen at any time, press **DTAD**.

Record a memo

You can record a memo to be played back later with the incoming messages.

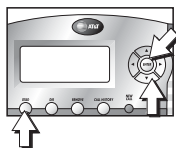

1. Press **DTAD** to access the answering system.
2. Press **▼** until the screen display includes **RECORD MEMO.**
3. Press **ENTER**. After the beep, start recording your memo. The screen display includes **Memo Recording.**
4. Press **ENTER** to stop recording. The screen displays the number of messages and **RECORD MEMO.**

NOTE: To exit DTAD and return to the idle screen at any time, press **DTAD**.

Record a phone conversation

You can record both parties on a phone conversation to play back later with incoming messages.

NOTE: This phone does not sound warning beeps to let the other party know that the call is being recorded. To ensure that you are in compliance with any state and federal regulations about recording a telephone call, you should inform the other party that you are recording the call before starting the recording process.

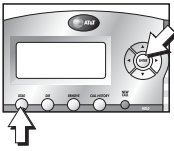

1. While on a call, press **DTAD**. The screen includes RECORD CALL.
2. Press **ENTER** to begin recording the conversation. The screen display includes a timer which counts the length of your recording.
3. Press **ENTER** to stop recording.

NOTE: To exit DTAD and return to the idle screen at any time, press **DTAD**.

Audible message alert

Program the audible message alert to On if you want the phone to beep every 30 seconds to notify you of the new messages. (See **Turn audible message alert on or off** on page 52.) The audible message alert does not sound while you are on a call.

Answering system Auto-attendant operation

NOTE: The auto-attendant feature only works with a multi-phone system. If this phone is the only telephone in your system, DO NOT select `AutoAttendant` for the answer status.

You can set this phone to function as an auto-attendant for a multi-phone system. A phone designated as an auto-attendant will pick up and redirect incoming calls to other extensions in the system. To set this phone to be an auto-attendant, follow the instructions to **Set answering system status** on page 43 of Feature setup and choose `AutoAttendant` in **step 4**.

Each auto-attendant can pick up only one line at a time, so you may wish to have more than one auto-attendant within your telephone system. You can designate up to 16 auto-attendants in your system. (See **Using multiple auto-attendants** on page 115 for further information.)

When you designate a phone to be an auto-attendant, you will need to program the day and night times (see **Set auto-attendant day and night times** on page 47 in Feature setup). The auto-attendant will use the times you program to determine which outgoing announcement to play.

There are three different auto-attendant outgoing announcements available. You can choose to record your own auto-attendant outgoing announcements or use the pre-recorded announcements listed here.

The auto-attendant day outgoing announcement

(`AA Day-OGM`), plays during the day time you program. The pre-recorded announcement is: *"Thank you for calling our company. If you know your party's extension, you may dial it at any time. For a company directory, please dial zero."*

The auto-attendant night outgoing announcement

(`AA Night-OGM`), plays during the night time you program. The pre-recorded announcement is: *"Thank you for calling our company. We are currently closed. If you would like to leave a message and you know your party's extension, you may dial it now. For a company directory, please dial zero."*

The auto-attendant auxiliary outgoing announcement (`AA Aux-OGM`)

, plays when an outside caller presses `0` on their phone after hearing the day or night announcement. The pre-recorded announcement is: *"Please enter the extension number."*

- Ⓢ **NOTE:** If you will be retaining the pre-recorded auto-attendant day and night outgoing announcements, you **MUST** record your directory of extension assignments as the auto-attendant auxiliary outgoing announcements (See **Record an auto-attendant outgoing announcement** on page 113 for instructions.)

Auto-attendant sequence for callers

When you set this phone to be an auto-attendant, it automatically picks up a ringing line after the pickup time you programmed (see **Set auto attendant pickup delay** on page 46 in Feature setup), and plays the appropriate auto-attendant outgoing announcement.

When a caller enters an extension number after hearing the announcements, the auto-attendant transfers the call to that extension and announces to the caller, *“Calling that extension, please wait.”*

The auto-attendant continues to monitor the call after it is transferred. If the requested extension doesn't pick up within 66 seconds, the unit announces, *“That extension is not answering. Please enter the extension number.”* The auto-attendant will try to transfer the call up to three times. If the call is not picked up by any extension during those attempts, the call is dropped.

- Ⓢ **NOTE:** If someone at the requested extension picks up the call and subsequently places the call on hold again, that extension must pick up the call again within 20 minutes or the call will be dropped. This applies when each time the same call is placed on hold.

If the caller does not enter an extension number after hearing the announcement, the auto-attendant waits about 12 seconds, then transfers the call to extension 11. If the call is not picked up after 66 seconds, the auto-attendant will answer the call again, play *“Please enter the extension number,”* and wait 12 seconds for the entry. If the caller still doesn't enter an extension number, the auto-attendant announces, *“That extension is not answering,”* and drops the call.

If the caller presses [0] after hearing the message, the auto attendant auxiliary outgoing message plays. The caller can then decide to enter an extension number or not and the auto-attendant responds as described above.

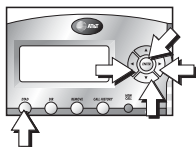

Review an auto-attendant outgoing announcement

1. Press **[DTAD]** to access the answering system.
2. Press **[▼]** until the screen display includes OGM PLAY&RECORD.
3. Press **[ENTER]**. The screen display includes PLAY and the current announcement setting.
4. Press **[◀]** or **[▶]** to choose the outgoing announcement you want to review (ANS-OGM, AA Day-OGM, AA Night-OGM, or AA Aux-OGM).
5. When the desired announcement is shown, press **[ENTER]**. The announcement starts to play and the screen display includes Playing and the selected announcement.
6. Press **[ENTER]** to stop playback.

⊙ NOTE: To exit DTAD and return to the idle screen at any time, press **[DTAD]**.

Record an auto-attendant outgoing announcement

NOTE: If you choose not to record an outgoing announcement, the answering system plays a pre-recorded announcement. The pre-recorded auto-attendant outgoing announcements are described on page 110.

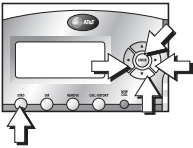

1. Press **[DTAD]** to access the answering system.
2. Press **[▼]** until the screen display includes: OGM PLAY&RECORD.
3. Press **[ENTER]**. The screen display includes PLAY and the current announcement setting.
4. Press **[◀]** or **[▶]** to choose the outgoing announcement you want to review (ANS-OGM, AA Day-OGM, AA Night-OGM, or AA Aux-OGM).
5. When the desired announcement is shown, press **[▼]** until the screen display includes RECORD and the selected announcement.
6. Press **[ENTER]**. After the system beeps, speak toward the phone in a normal tone of voice without any background noise. While you are recording, the screen display includes Recording and the selected announcement.
7. To stop recording, press **[ENTER]**. The system automatically plays back your announcement.

NOTE: To exit DTAD and return to the idle screen at any time, press **[DTAD]**.

Remove an auto-attendant outgoing announcement

NOTE: When you erase your announcement, the system returns to the pre-recorded announcement until you record a new one.

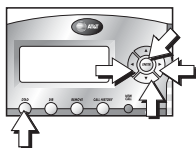

1. Press **[DTAD]** to access the answering system.
2. Press **[▼]** until the screen display includes OGM PLAY&RECORD.
3. Press **[ENTER]**. The screen display includes PLAY and the current announcement setting.
4. Press **[◀]** or **[▶]** to choose the outgoing announcement you want to review (ANS-OGM, AA Day-OGM, AA Night-OGM, or AA Aux-OGM).
5. When the desired announcement is shown, press **[ENTER]**. The announcement starts to play and the screen display includes Playing and the selected announcement.
6. While the outgoing announcement plays, press **[REMOVE]** twice to erase the announcement.

NOTE: To exit DTAD and return to the idle screen at any time, press **[DTAD]**.

Using multiple auto-attendants

You may wish to set one or more additional phones to act as auto-attendant(s) when the primary auto-attendant is turned off or busy.

An auto-attendant is busy when someone at that extension is:

- programming the phone, or
- accessing messages, or
- on an intercom call, or
- dialing from the directory or call history, or
- using any of the lines to make or answer a call, or
- when the DTAD is recording a message at that extension.

You can choose a particular extension to always be the primary auto-attendant by setting that extension to have the shortest auto-attendant pickup delay and setting the pickup delays of other auto-attendants in the order you choose. Otherwise, the primary auto-attendant may change as the system automatically assigns incoming calls among active auto-attendants.

⦿ **NOTE:** When multiple auto-attendants are used, program the pickup times with at least three seconds among them to avoid more than one auto-attendant trying to pick up a single call at the same time. To program pickup times, see **Set auto-attendant pickup delay** on page 46 in Feature setup.

Answering system

Remote operation

You can access many features of this answering system when you are away from your phone. The remote commands are the same whether you are calling from a remote, non-system touch tone phone or from another extension in the phone system. Only the method for connecting with the answering system differs.

Connect with the answering system

From a touch tone phone outside the telephone system

1. Dial your telephone number.
2. When the DTAD outgoing announcement begins to play, enter your remote code (see **Program the remote code** on page 50 in Feature setup).
3. Enter the remote commands (see **Remote commands** on page 117).
4. To exit remote operation, hang up. The answering system will automatically disconnect your call if you do not enter a command within 20 seconds.

From another extension within the telephone system

1. Page the extension of the answering system you wish to reach (see **Page a specific extension** on page 88 in Intercom operation).
2. Enter your remote code within 20 seconds. (See **Program the remote code** on page 50 in Feature setup).
3. Enter the remote commands (see **Remote commands** on page 117).
4. To exit remote operation, hang up. The answering system will automatically disconnect your call if you do not enter a command within 20 seconds.

Remote commands

Play messages

1. Press **7** to play new messages.
—OR—
 Press **7** **(X)TONE** to play all messages.
2. To replay the previous message, press **2**.
 To skip to the next message, press **3**.
 To stop message playback, press **8**.
 To save messages, hang up.

Remove messages

To remove a selected message, press **#****#** while the message is playing.

—OR—

To remove all messages, press **#** **(X)TONE**.

Record a memo

Press **9** to record a memo to be played back with other incoming messages.

Review outgoing announcements

1. Press **4** to hear the auto-attendant day outgoing announcement.
—OR—
 Press **5** to hear the auto-attendant night outgoing announcement.
—OR—
 Press **6** to hear the auto-attendant auxiliary outgoing announcement.
—OR—
 Press **7** to hear the DTAD outgoing announcement.
2. Press **8** to stop message playback.

Turn off the answering function

Press **0**.

To exit remote operation, hang up.

Adding a fax machine

NOTE: Do not connect a fax machine to line 1. Doing so will interrupt the telephone's intercom data channel.

You may wish to use a fax machine with your phone. Choose line 2, 3 or 4 for the fax machine, and connect it according to the manufacturer's instructions for installation and use.

- That line's telephone number is your fax number.
- The same line can be used for outgoing calls (incoming faxes will get a busy signal when the line is in use).
- Set your fax machine to answer on the first ring (follow manufacturer's instructions).
- To prevent the fax line from ringing at all the extensions, turn the ringer off for that line at other extensions (see **Turn the ringer on or off for each line** on page 27).

NOTE: If you are using a fax switch, or a fax machine with a built-in fax switch, see **Using a fax switch** below.

Using a fax switch

A fax switch lets the telephone know, before the phone rings, whether an incoming call is a voice call or a fax call. Some fax machines have a built-in fax switch. Using a fax switch may affect the operation of the **LINE** lights or other system features.

General product care

To keep your phone working and looking good, follow these guidelines:

- Avoid putting it near heating appliances and devices that generate electrical noise (for example, motors or fluorescent lamps).
- DO NOT expose it to direct sunlight or moisture.
- Avoid dropping the phone and/or other rough treatment.
- Clean with a soft cloth.
- Never use a strong cleaning agent or abrasive powder because this will damage the finish.
- Retain the original packaging in case you need to ship it at a later date.

Technical specifications

Technical specifications

REN	0.3B
Power adapter	Input: AC 120V, 60Hz Output: DC 12V, 500mA
Battery	One 9V alkaline battery required
Intercom signal frequency	Data 455 KHz

Technical specifications

In case of difficulty

If you have difficulty operating this phone, try the suggestions below.

For customer service, visit our website at www.telephones.att.com or call **1 (800) 222-3111**. **Have the serial number, found on the underside of your phone available when contacting customer service. Please retain your receipt as your proof of purchase.**

To purchase accessories or replacement parts, please contact customer service by visiting our website at www.telephones.att.com or calling **1 (800) 222-3111**.

Telephone operation

Problem

Telephone does not work properly.

Solution

- This 984 telephone is not compatible with any 843, 853, 854, 874, or 954 telephones you may have previously installed.

Problem

No dial tone.

Solution

- Make sure all plugs are connected properly. Inspect the line cord connections at the modular jack(s) and at the telephone. Also inspect the coiled handset cord connection at both ends.
- Make sure a line is selected.
- Make sure **HOLD** is not activated.
- If you do not hear a dial tone when you press **HEADSET**, make sure the headset is firmly connected at the jack.

Problem

Telephone does not ring.

Solution

- Make sure the Do not disturb (DND) feature is not activated.
- Make sure the ringers are turned on.
- If there are several non-system phones on the line that don't ring, disconnect some of them. Having too many phones connected can also result in low ringer volume for non-system telephones.
- If the **INTERCOM** light flashes but you don't hear a paging signal, make sure the Do not disturb feature is not activated.

Telephone operation

Problem

A repeating short ring (error ring) sounds at all extensions when you assign an extension number to your phone.

Solution

The extension number you chose is already assigned. Begin again and choose a different extension number from 11 to 26 (see **Assign an extension number to your phone** on page 26). You **MUST** assign a different extension number to every phone in your system.

Problem

Intercom paging signal not received.

Solution

Make sure you have programmed your intercom extension number correctly. Line 1 must be connected at all extensions, and must be the same telephone number/line for paging and intercom to work properly.

Problem

Cannot join a conversation in progress.

Solution

The call privacy feature prevents another set on the system from interrupting a conversation. Make sure you press the **LINE** button to release privacy. (See **Call privacy** on page 60.)

Problem

Error tone (fast busy signal) heard when making a page call.

Solution

The Do not disturb feature is activated at the extension you are calling.

Problem

A double beep sounds every 30 seconds.

Solution

There is a call on hold at this extension. Press and release the **LINE** button of the call on hold to return to the call and turn off the reminder beep.

Telephone operation

Problem

LINE lights remain on when no line is connected.

Solution

- Make sure the phone is programmed for that line to be absent. (See **Turn line usage on or off for each line** on page 33.)
- Make sure that your line groups are programmed properly. (See **Assign the line group for this phone** on page 41.)
- Disconnect all other devices (fax, modem, credit card reader, etc.) from any lines connected to your phone. These devices can interfere with the telephone's data links.
- Make sure the total length of telephone wiring used in your phone system is less than 600 feet as it may cause interference with the advanced features of this telephone.
- If you are a DSL service subscriber, please see **DSL users** beginning on page 4 for details.

Problem

Tone signals do not activate a remote device.

Solution

Tone signaling does not work during conference calls.

In case of difficulty

Telephone operation

Problem

Operation during a power failure.

Solution

This phone will operate during a power failure if a working battery has been installed. You will be able to answer calls with the handset or headset, and dial calls using the dial pad keys and the one touch or redial features. No other features will work until power is restored. All programming is retained during a power failure.

Problem

The screen displays Power fail.

Solution

The phone has been disconnected from AC power. When power is restored, a key is pressed, or the phone is taken off the hook, the screen will return to the usual display. One touch and redial numbers are retained until power is restored.

Problem

Display screen is blank.

Solution

Make sure the power cord is connected to both the phone and an electrical outlet not controlled by a wall switch.

Problem

Intercom, hold, call privacy or other advanced features do not work properly.

Solution

If you are a DSL customer, you may need to arrange for installation of a splitter. See **DSL users** beginning on page 4 for details.

Caller ID operation

Problem

No caller ID information while on a call.

Solution

- You must subscribe to **combined** caller ID with call waiting as a **single** service to see call waiting information.

Problem

No caller ID information is received.

Solution

Caller ID information is transmitted by the telephone company between the first and second rings. Allow your phone to ring at least twice to receive caller ID information.

Problem

NEW CALL light flashes.

Solution

- Make sure you have reviewed all messages on all lines.
- You may have received a false signal from the central office. To clear, see **Reset COVM indicator** on page 39 in Feature setup.

Problem

Screen displays COVM.

Solution

The screen displays COVM when the COVM indicator is turned on for at least one line, whether or not there are messages waiting, and whether or not you have voice mail service.

If you subscribe to voice mail service with your local telephone company, but prefer not to display COVM on the screen, turn off the COVM indicator for each line.

If you do not subscribe to voice mail service, turn off the COVM indicator for all lines.

See **Turn COVM indicator on or off for each line** on page 38 in Feature setup for detailed instructions.

Caller ID operation

Problem

COVM line indicator remains on.

Solution

- Make sure you have reviewed all messages on that line.
- You may have received a false signal from the central office. To clear, see **Reset COVM indicator** on page 39 in Feature setup.

Answering system operation

Problem

Messages are incomplete.

Solution

If message length is programmed to 1 minute, messages longer than this duration will be cut off. See **Set message length** beginning on page 51 in Feature setup to change message length to Unlimited.

Problem

Answering system does not answer after correct number of rings.

Solution

- See **Set answer delay** beginning on page 45 in Feature setup to change how long the phone rings before the answering system picks up a call.
- DTAD features only work when the answering function is turned on. See **Set answering system status** on page 43 in Feature setup.
- If a fax machine that shares a line with the answering function is turned on, the answer delay must be programmed to allow the fax machine to answer calls first.

Problem

Answering system will not record messages.

Solution

- When DTAD memory is full, saved messages must be deleted before new messages can be recorded.
- Make sure message length is NOT set to Greeting Only. (See **Set message length** beginning on page 51 and choose Unlimited or 1 minute.)

Answering system operation

Problem

Answering system does not respond to remote commands.

Solution

- Make sure you are calling from a touch tone phone. When you dial a number, you should hear tones. If you hear clicks instead, the phone is not a touch tone telephone.
- There may be noise or interference on the phone line you are using. Press dial buttons firmly.
- You might be calling from a phone that sends tones which are too short for this 984 telephone to detect.

Problem

Incoming calls are dropped by auto-attendant.

Solution

Make sure you have recorded the auto-attendant outgoing announcements and your directory of extension assignments. (See Answering system Auto-attendant operation beginning on page 110.)

Problem

Difficulty intercepting a call during message recording.

Solution

- DTAD intercept must be turned on. (See **Turn DTAD intercept on or off** on page 54.)
- You must use a phone connected to the line of the incoming call.
- If you are using a non-system phone, press **#1** to intercept the incoming call.

Expanding the phone system

Maximum number of units allowed to be connected in the phone system

1. With the use of ONLY 984, 974 and 945 telephones in a system, this combination allows a maximum number of 16 units to be connected in the system.
2. If the combination includes any of the 944, 955 and 964 telephones, the maximum number of phones that can be connected to the system is 12 units.

Maximum number of telephone lines allowed to be connected to the system

1. With the use of ONLY 984, 974 and 945 telephones in a system, this combination allows a maximum number of 16 phone lines to be connected to the system.
2. If the combination includes any of the 944, 955 and 964 telephones, the maximum number of telephone lines that can be connected to the system is 15.

NOTE: All 984 features work as described earlier in this manual.

NOTE: Please refer to page 15 for the diagram of the **Recommended wiring configuration for phone system.**

Line groups

Your 984 telephone is noted for its line-sharing feature. The four-line CO key indicators show the line status by displaying different colors and modes (on / off / flashing). To have an accurate line status indication, all units which are connected to the system MUST have their Line 1 jacks connected to the same telephone line (i.e. TL1), Line 2 jacks connected to the same telephone line (TL2), and Line 3 jacks connected accordingly to (TL3).

There are 12 line group numbers to select, 1-4. Refer to the table below for the various line-group combination which results from using 16 units and 7 telephone lines.

	Telephone Lines in System							Line Group Number	Example of Function	
	TL 1	TL 2	TL 3	TL 4	TL 5	TL 6	TL 7			
Intercom Extensions	EXT 11	✓	✓	✓		✓		Group 4	Marketing	
	EXT 12	✓	✓	✓	✓			Group 6	Procurement	
	EXT 13	✓	✓	✓		✓		Group 4	Marketing	
	EXT 14	✓	✓	✓			✓	Group 5	Engineering	
	EXT 15	✓	✓	✓		✓		Group 4	Marketing	
	EXT 16	✓	✓	✓	✓			Group 6	Procurement	
	EXT 17	✓	✓	✓			✓	Group 5	Engineering	
	EXT 18	✓	✓	✓			✓	Group 5	Engineering	
	EXT 19	✓	✓	✓				✓	Group 7	Administration
	EXT 20	✓	✓	✓				✓	Group 7	Administration
	EXT 21	✓	✓	✓	✓				Group 6	Procurement
	EXT 22	✓	✓	✓		✓			Group 4	Marketing
	EXT 23	✓	✓	✓			✓		Group 5	Engineering
	EXT 24	✓	✓	✓		✓			Group 4	Marketing
EXT 25	✓	✓	✓	✓				Group 6	Procurement	
EXT 26	✓	✓	✓				✓	Group 7	Administration	

All L1, L2 & L3 jacks are to be connected to the same corresponding Telephone Lines (TL1, TL2 & TL3).

These can be set in Option Menu → Special Options → Line Group

- NOTE:** The L1 jacks of all the units must be connected to the same corresponding telephone line (TL1) to ensure proper functioning of the phone system.
- NOTE:** The L2 jacks of all the units must be connected to the same corresponding telephone line (TL2). Likewise, the L3 jacks to the same corresponding telephone line (TL3). If the L1- L3 jacks are not properly connected to their telephone lines, the four-line CO key status indicators will NOT reflect the actual telephone line status.
- NOTE:** For all units connected to TL1, the total length of telephone wiring MUST NOT exceed 600 feet when used in this phone system.

Private lines

This feature allows you to set a private line (direct line) to the Line 4 jack of each unit. In this case, all 16 units can have their own private lines, and the connection of 16 units together adds up to a total of 19 telephone lines. The table below shows an example of how 16 extensions are connected to add up to 19 telephone lines.

		Telephone Lines (TLs) in System																		
		TL1	TL2	TL3	TL4	TL5	TL6	TL7	TL8	TL9	TL10	TL11	TL12	TL13	TL14	TL15	TL16	TL17	TL18	TL19
Intercom Extensions	EXT 11	✓	✓	✓	✓															
	EXT 12	✓	✓	✓		✓														
	EXT 13	✓	✓	✓			✓													
	EXT 14	✓	✓	✓				✓												
	EXT 15	✓	✓	✓					✓											
	EXT 16	✓	✓	✓						✓										
	EXT 17	✓	✓	✓							✓									
	EXT 18	✓	✓	✓								✓								
	EXT 19	✓	✓	✓									✓							
	EXT 20	✓	✓	✓										✓						
	EXT 21	✓	✓	✓											✓					
	EXT 22	✓	✓	✓												✓				
	EXT 23	✓	✓	✓													✓			
	EXT 24	✓	✓	✓														✓		
	EXT 25	✓	✓	✓															✓	
	EXT 26	✓	✓	✓																✓

To L4 jack
TL4 to TL19 are private lines

- Ⓞ **NOTE:** To program a private line in a line group, press **ENTER** to begin feature setup and then select **SPECIAL OPTIONS**. Enter the Line group menu and select **PRV** to set the private line.
- Ⓞ **NOTE:** If the unit (extension) is not set to **PRV**, the Line 4 status indicator will be unable to display a correct line status.

Centrex operation

Setup checklist

Before expanding your system or installing for Centrex, review the installation checklist. If you have Centrex, contact your local telephone company for further information about Centrex service.

- The phone number for line 1 must be the same on all phones in order for the intercom and page features to work.
- Determine the number of phones that will be on the system.
- Identify the phone that will be the console phone.
- Identify the private line for the console phone. The console phone must have its own private line. This line is not shared with any other phone.
- Follow the regular installation instructions in this manual.
- Enable the console phone.
- Store the Centrex pickup codes and the seven-digit phone numbers in one touch locations. (See **One touch operation** beginning on page 70.)

Enable the console phone

Determine which phone will be the console phone for your system and program the console following the directions to **Set this phone to be the Centrex console phone** on page 55. It is recommended that Line 4 of the console be programmed as a private line, to be sure a line is available for Centrex access.

Console operation

Once another system phone has enabled its delayed ring, the console phone will receive those calls. All the 984 features work in the same manner as described in this manual.

The console phone can pick up other Centrex lines through Centrex switching. You can store the Centrex pickup codes and the seven-digit phone number of each station, except for the console phone, in the one touch locations.

Set ring delay duration

This feature allows other system telephones' calls to ring at the console phone. After a specified ring delay, the calls will ring at the console phone. (See **Set the Centrex console delayed ring time** on page 56.)

Answer a delayed ring

The console phone rings and the screen displays the extension number of the intercom sending the delayed ring.

1. Select a free line.
2. Enter the Centrex pickup code.
3. Enter the seven-digit phone number of the extension sending the delayed ring.

NOTE: If the console is using another line and receives a delayed ring, the console phone can put the other line on hold and follow **steps 1–3**. If the console is on an intercom call, the intercom call should be ended before picking up the ringing phone.

Pick up another station's line

1. Choose a free Centrex line.
2. Enter the Centrex pickup code.
3. Enter the seven-digit phone number of the line you want.

Index

- ▲ [984] 6, 22, 24, 62, 75, 92, 102
- ▼ [984] 6, 22, 24, 62, 75, 92, 102
- ◀ [984] 6, 22, 24, 75, 92, 102
- ▶ [984] 6, 22, 24, 75, 92, 102
- ☎ [984] 22
- ☎ [984] 22

A

- AA,
- ANS-OGM, 103
- AUX-/Day-/Night-OGM, 103, 110
- AA Night-OGM, 103, 110
- AM/PM 32
- Announcements 51, 101
- Answer a call 57–58, 87
- Answer delay 10, 45, 49, 126
- Answer status 10, 43, 110
- Answering system 6, 10, 43–45, 47, 49, 51, 69, 101, 103–108, 112–114, 116, 117, 126
- Answering system,
 - does not answer after correct number of rings, 126
 - does not respond to remote commands, 127
 - will not record messages, 126
- AREA CODES 9, 40
- Audible message alert 11, 52, 109
- AUTO ATT DELAY 10, 45
- Auto redial 62, 68
- (AUTO) REDIAL** 62, 71, 77
- Auto-attendant 5, 10, 43, 46–47, 110–111, 115

- Auto-attendant,
 - auxiliary outgoing announcement, 110–111
 - day outgoing announcement, 110
 - night outgoing announcement, 110
 - outgoing announcement, 110, 112–114
 - pickup delay, 46, 111, 115

Auto-mute 8, 30, 88, 90

Automatic line selection 57, 59

Automatic mode 9, 35, 62, 74, 87

Aux L3/L4 jack 21

B

Base 13–14

Battery, 13–14, 17, 20, 120, 124
compartment, 13–14

Blind transfer 66

C

- Call,
 - history, 69, 91–92, 95–100, 115
 - information, 91–96
 - privacy, 60
 - record, 97
 - volume, 61
 - waiting 64–93

Caller,

- ID, 5, 9, 75, 91–93, 95
- ID with call waiting, 5, 91, 93
- identification, 5, 91
- information, 96

CANCEL 71

Cannot join a conversation
in progress 122

Central Office Voice Mail 5

Centrex, 5, 55–56, 131–132
 console delayed ring, 56
 console phone, 11, 55
 pickup code, 131–132

Conference call 65, 123

Console phone 11, 131–132
 See also Centrex console
 phone

Convenience ports 21

COVM, 5, 125
 indicator 9, 38–39
 on or off, 9, 38
 reset, 39

CSL DELAY RING 11

D

DTAD, 6, 101–109, 112–114, 126
 intercept, 11, 54, 105, 127
 memory, 101, 107, 126
 outgoing announcement, 116

Date, set 32

Day time 47, 110

DAY/NIGHT TIMES 10, 47

Default mode 58, 59

Default settings 42

Delayed ring 29, 131–132

Dial,
 mode, 31
 options, 98
 pad keys, 76–77, 79–80
 pulse (rotary), 64, 72, 78
 tone, 17, 20, 58, 61, 74, 121

Dialing sequence 72, 77–78

Difficulty intercepting a call during
 message recording 127

Digital subscriber line/DSL 4

134

Directory, 75–82, 99
 card, 70
 full, 75
 of extension assignments, 111, 127

Display screen is blank 124

DND, 6, 12, 60, 68
 (Do not disturb) 6, 68, 83,
 121–122,
 light, 60

Double beep sounds every 30
 seconds 122

DSL,
 filters, 4
 service, 4–5, 83
 splitter, 4–5

DTAD,
 full, 107
 light, 69, 101

E

English 24, 56

ENTER 6, 22, 62, 67, 75, 88–90

Erase all settings 42

Error ring 13, 26

Error tone (fast busy signal) heard
 when making a intercom call 122

Español 24, 56

EXT button 25, 66–67, 70–71,
 73–74, 85–86, 88, 90, 100

Extension, 3, 13, 33, 60, 66–68, 83,
 85–90, 118, 122, 127, 129
 number, 3, 8, 12–13, 83, 87, 117,
 128

F

Fax, 123

machine, 21, 118, 126

switch, 118

Feature setup menu 22–23

Flash 64, 72, 78

Français 24, 56

G

Greeting Only 51

H

Hands-free 30, 58, 87

Handset, 2, 7, 9, 13, 16–18, 20, 35,
57–59, 61, 63–64, 67, 74, 83,
85–88, 121, 124

cord, 2, 16, 18, 121

tab, 18

Headset 1, 9, 13, 35, 57–59,
61–62, 64, 67–68, 74, 81, 86–88,
98, 121, 124
jack, 1, 58
light, 58, 68

Hearing-aid 1

Hold, 63, 121, 124
reminder, 8, 31, 63

Home area code 6, 9, 91

Hour, set 32

I

Idle screen 106

Incoming,
call, 33, 46, 49, 58, 60, 105, 118,
127
calls are dropped by auto
attendant, 127
intercom call, 12, 68messages, 11, 53, 105, 108–109,
117

Initializing 17, 20

Intercom, 12, 25–26, 33, 83, 84,
85–87, 90, 122, 124, 130. See
also Centrex console phone
call, 28, 63, 65, 68, 70, 85–87Intercom,
conference call, 90
light, 60, 68, 121Intercom paging signal not
received 122**L**

L1/L2 jack 16

L3/L4 jack 16

Language 11, 24, 56

LCD Backlight 9, 37

Line,

1 phone number, 3
button, 35, 57–60, 62–63, 65,
81, 98, 122
cords, 2, 15–16, 18–20, 121
group, 6, 9, 40–41, 123,
128–130
light, 60, 63, 68, 118, 123
lights remain on, 123
preference, 34. See also prime
line

Line usage, 33, 123

Local area code 6, 9, 91

LOW BATT 67

LOWER 70, 71, 73–74**M**

Make a call 57–58

Memo 51, 101, 108, 117

Menu,
 item, 22
 operation, 22–23, 75, 92, 102

MESSAGE,
 ALERT, 11, 52
 LENGTH, 11, 51

Message,
 playback, 106–107
 waiting light, 95

Messages, 11, 49, 51, 53, 69, 101,
 106–109, 117, 126
 are incomplete, 126

Microfilters 4

Minute, set 32

Monitor 11, 53, 105

Month, set 32

Multi-phone system 6, 10, 43–44,
 47, 110

Mute, 64, 68
 light, 64, 68, 88

N

Navigation buttons 6, 22, 75, 92,
 102

NEW CALL light 69, 95

Night time 47, 110

Non-system phone 60, 105, 121,
 127

O

One touch, 13, 25, 70–74, 100,
 124
 (EXT) buttons, 8
 locations, 42, 70–71, 130
 number, 74
 preference, 8, 25, 70, 74, 85–86

Outgoing,
 announcement, 5, 47, 51,
 103–105, 110–111, 113, 117
 calls, 118
 or transfer calls, 33

Outside line 65, 84, 90

P

Paging, 3, 33, 60, 67, 88–90,
 121–122
 only, 33

Page,
 all, 84
 call, 90

Password 11, 50

Pause 72, 77

Phone system 3–4, 6, 11, 44, 60,
 83, 87, 89, 123, 128

Power,
 adapter, 2, 17–21, 120
 cord, 17, 20, 124
 failure, 13, 17, 20, 124
 jack, 17, 18

Pre-recorded announcement 103,
 105, 110, 113–114

Primary auto-attendant 115

Prime line 7, 9, 34, 57

Privacy 30, 122

Private,
 line, 3, 130–131
 Name, 94
 Number, 94

PRV 9, 41, 130

Pulse 30–31

R

- Rapid scroll 9, 24, 36
- Redial, 13, 61–62, 69, 124
 - memory, 61, 62
- Reminder beep 63, 122
- Remote code 11, 23, 50, 116
- Remote commands 116–117, 127
- Remove all? 82, 97
- Removed! 81, 97, 108
- Repeating short ring (error ring)
 - sounds at all extensions 122
- RESET ALL 41–42
- Reset! 39, 42
- Return to the conversation 64
- Ring,
 - delay, 132
 - pattern, 8, 28, 83, 87
- Ringer, 27, 118, 121
 - on/off, 8, 23, 27, 118
 - type, 8, 23, 28
 - volume, 61
- Room monitor 30, 90

S

- Save messages 107, 117
- Screen,
 - backlight, 37
 - display, 11, 22
- Screen displays Powerfail 124
- Scroll,
 - button, 24
 - rate, 9, 23, 36
- Single,
 - phone (system), 10, 43
 - phone page, 83, 88

- Speaker, 11, 68, 84, 90, 105
- SPEAKER light 58
- Speakerphone 1, 9, 35, 57–59,
 - 61–64, 67–68, 74, 81, 83, 86–88, 90, 98
- Splitter 4–5, 124
- Stored! 71
- Switch lines 63
- Switchhook 18, 64, 78
- System,
 - phone, 1, 6–7, 60, 66, 83, 89–90, 105, 121, 127, 131
 - wide page, 83–84, 89

T

- Telephone does not ring 121
- Telephone,
 - lines, 1, 3, 128–130
 - system, 1, 3, 13, 26, 83, 110, 116
 - wiring, 3, 123, 129
- Temporary tone, 64, 72, 78
 - signal, 72, 78
- Three-party call 65
- Three-way calling 64
- Time,
 - set time/date, 8, 23, 32
- Timer 59, 109
- Toll Saver 11, 48–49
- X-TONE** 64
- Tone signals do not
 - activate a remote device 123
- Touch tone 8, 64, 72, 116

Transfer,
calls, 66–68
ring, 67

Two-line adapter 16, 19, 21

U

Unknown,
Name, 94
Number, 94

Unlimited 11, 51, 126

Unused lines 33

V

Voice mail (service), 29, 38, 95,
125

VOLUME ▲, ▼ 61



In case of difficulty, visit our service center at
www.telephones.att.com or call **1 (800) 222-3111**.

© 2006 Advanced American Telephones.

All Rights reserved.

AT&T and the Globe Design are
trademarks of AT&T Corp., licensed to
Advanced American Telephones.

Printed in Singapore. Issue 3AT&T 03/06