

OWNERS MANUAL

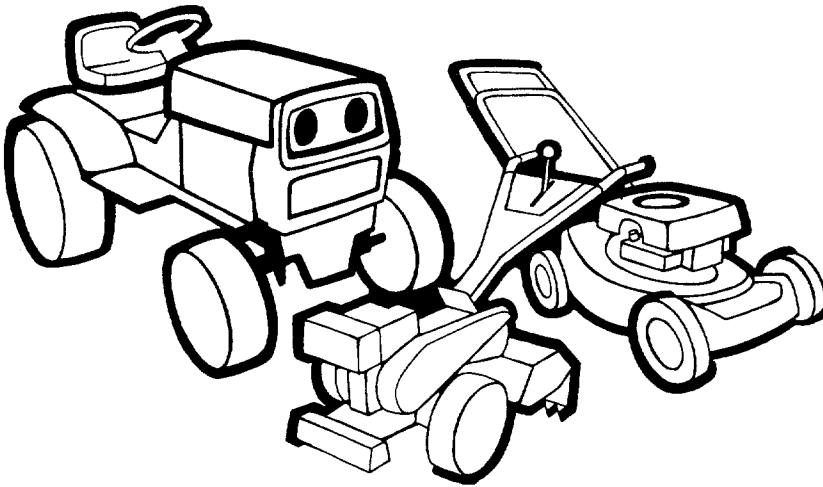

POWER VACUUMS

**ASSEMBLY
OPERATION
MAINTENANCE
PARTS LIST**

**Important:
Read Safety Rules and
Instructions Carefully**

Model Numbers

244-675-000

244-685-000

244-689-000

24677L

24687L

Thank you for purchasing an
American built product.

INDEX

Safe Operation Practices	3	Maintenance	10
Assembly Instructions	4	Off-Season Storage	
Operation	9	Illustrated Parts	12, 14
Adjustments	9	Replacement Parts List	13, 15
Lubrication	10	Parts Information.....	Back Cover

LIMITED WARRANTY

For one year from the date of original retail purchase, MTD PRODUCTS INC will either repair or replace, at its option, free of charge, F.O.B. factory or authorized service firm, any part or parts found to be defective in material or workmanship. Transportation charges for the movement of any power equipment unit or attachment are the responsibility of the purchaser. Transportation charges for any parts submitted for replacement under this warranty must be paid by the purchaser unless such return is requested by MTD PRODUCTS INC.

This warranty will not apply to any part which has become inoperative due to misuse, excessive use, accident, neglect, improper maintenance, alterations, or unless the unit has been operated and maintained in accordance with the instructions furnished. This warranty does not apply to the engine, motor, battery, battery charger or component parts thereof. Please refer to the applicable manufacturer's warranty on these items.

This warranty will not apply where the unit has been used commercially.

Warranty service is available through your local authorized service dealer or distributor. If you do not know the dealer or distributor in your area, please write to the Customer Service Department of MTD.

The return of a complete unit will not be accepted by the factory unless prior written permission has been extended by MTD.

This warranty gives you specific legal rights. You may also have other rights which vary from state to state.



WARNING

TO PURCHASERS OF INTERNAL COMBUSTION ENGINE EQUIPPED MACHINERY OR DEVICES IN THE STATE OF CALIFORNIA

The equipment which you have just purchased does not have a spark arrester. If this equipment is used on any forest covered land, brush covered land, or grass covered unimproved land in the State of California, before using on such land, the California law requires that a spark arrester be provided. In addition, spark arrester is required by law to be in effective working order. The spark arrester must be attached to the exhaust system and comply with Section 1442 of the California Public Resources Code.

IMPORTANT

It is suggested that this manual be read in its entirety before attempting to assemble or operate. Keep this manual in a safe place for future reference and for ordering replacement parts.

This unit is shipped WITHOUT GASOLINE or OIL. After assembly, see separate engine manual for proper fuel and engine oil recommendations.

SAFE OPERATION PRACTICES FOR POWER VACUUMS

1. Read this operating and service instructing manual carefully. Be thoroughly familiar with the controls and proper use of the power vacuum.
2. Never allow children to operate this power vacuum.
3. Keep the area of operation clear of all persons, particularly small children and pets.
4. Check fuel before starting engine. Do not fill fuel tank indoors, when engine is running, or while engine is hot. Wipe off any spilled fuel before starting engine.
5. Do not change engine governor settings.
6. Do not put hands near rotating parts for any reason.
7. If the power vacuum should start to vibrate abnormally, stop the engine and check immediately for the cause. Vibration is generally a warning of trouble.
8. Before cleaning, repairing or inspecting, make certain all moving parts have come to a complete stop. Disconnect spark plug wire and keep wire away from plug to prevent accidental starting. Also keep throttle control lever in the stop position.
9. If the power vacuum should become blocked with debris at any point, shut engine off and wait until the impeller comes to a complete stop before attempting to remove the obstruction. Disconnect spark plug wire to prevent accidental starting.
10. Check all bolts for tightness at frequent periods.
11. Never store this power vacuum with fuel in the tank. Allow engine to cool before storing in any enclosure.
12. Keep bag and equipment free of debris when not in use.
13. Never operate this power vacuum unless air duct and vacuum bag are properly affixed in their place. Large zippered end of bag must be closed when operating to prevent objects from being blown out.
14. Never empty vacuum bag when engine is running.
15. Never change inlet nozzle or auxiliary hose attachment when engine is running.
16. The manufacturer recommends that the operator wear safety glasses or some other suitable eye protection when operating this machine.
17. Check the vacuum bag frequently for wear and replace when necessary.
18. Never operate as a leaf blower unless impeller guard and guard assembly are properly affixed in their place.
19. Exercise caution whenever operating as a leaf blower. Do Not allow discharge to be pointed in the direction of persons.

ASSEMBLY INSTRUCTIONS

CONTENTS OF HARDWARE PACK (See Figure 1.)

- A (1) Clutch Grip Assembly*
- B (1) Hair Pin Cotter*
- C (1) Clevis Pin*
- D (1) Extension Spring*
- E (1) Lock Nut 1/4-20 Thread*
- F (3) Hand Knobs
- G (3) Belleville Washers
- H (1) Heavy Flat Washer
- I (4) Hex Bolts 1/4-20 x 1.75" Long
- J (4) Hex Lock Nuts 1/4-20 Thread
- K (2) Stud Pins
- L (2) Push-on Speed Nuts
- (1) Hex Jam Nut 1/4-20 Thread* (Not Shown)

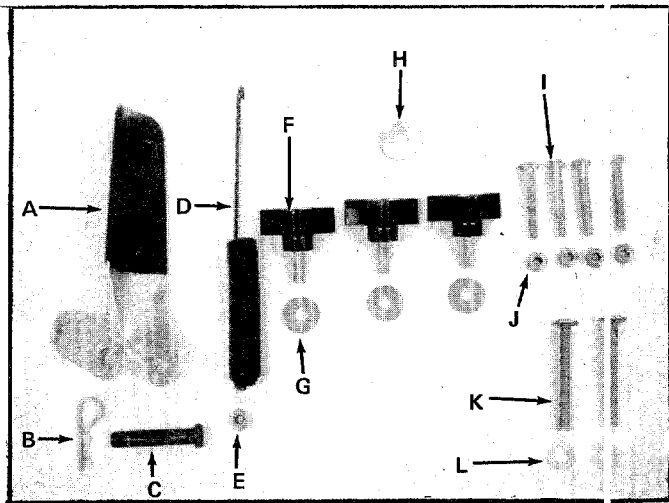

FIGURE 1.

LOOSE PARTS IN CARTON (See Figure 2.)

- M (1) Bag
- N (1) Nozzle
- O (1) Upper Handle
- P (1) Air Duct Assembly
- Q (1) Clutch Rod*
- R (1) Directional Discharge Assembly
- S (1) Impeller Guard

*Self-Propelled Models Only.

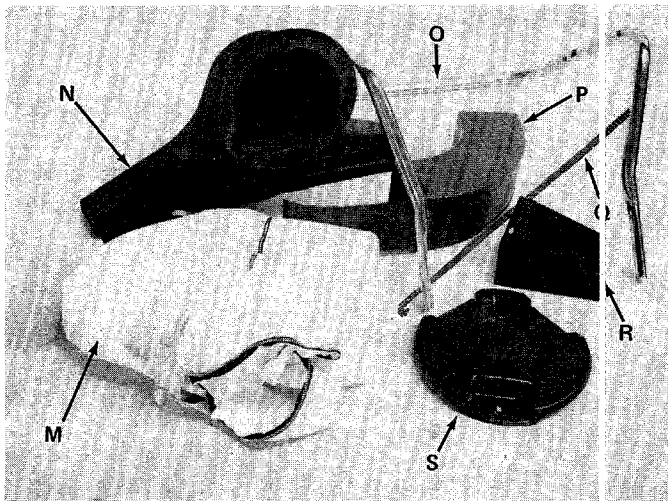

FIGURE 2.

TOW BAR KIT - Standard with push models. Optional (See figure 3.) with self-propelled models.

- T (2) Tow Bar Halves (Not Shown)
- U (2) Hex Bolts 5/16-18 x 1.00" Long
- V (4) Shoulder Spacers
- W (2) Hex Nut 5/16-18 Thread
- X (1) Truss Machine Screw 1/4-20 x .75" Long
- Y (1) Lock Washer 1/4" I.D.
- Z (1) Hex Nut 1/4-20 Thread
- AA (1) Shoulder Bolt
- AB (2) Belleville Washers 3/8" I.D.
- AC (1) Hex Jam Lock Nut 3/8-16 Thread

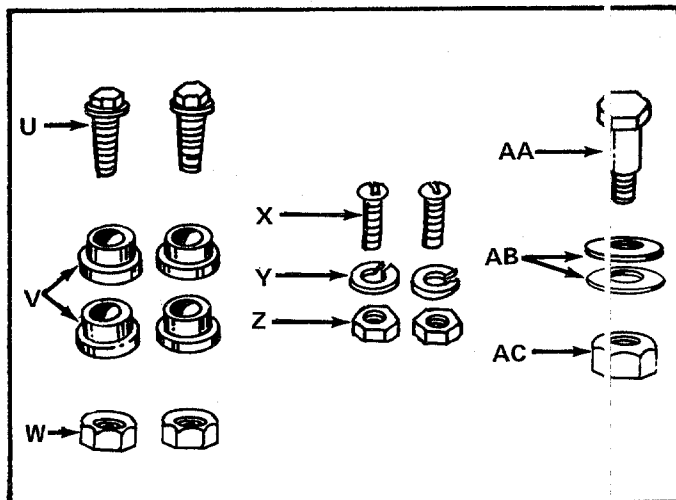
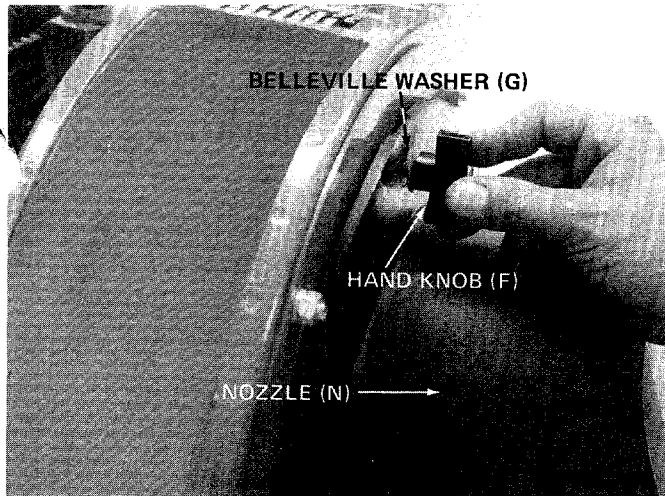
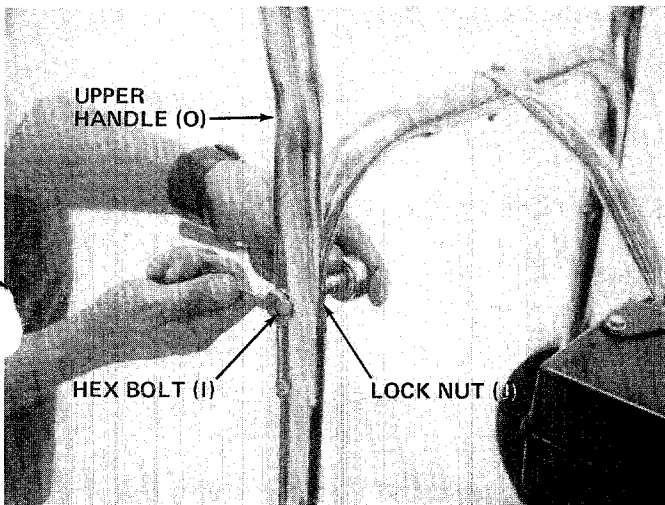

FIGURE 3.



1. Place nozzle (N) in position on front of housing so that it rests in flanges. Secure with one hand knob (F) and belleville washer (G). See figure 4.

FIGURE 4.



2. Place the upper handle (O) in position over lower handle. Fasten with four hex bolts (I) and lock nuts (J) provided. See figure 5. Two 7/16" wrenches are required.

FIGURE 5.

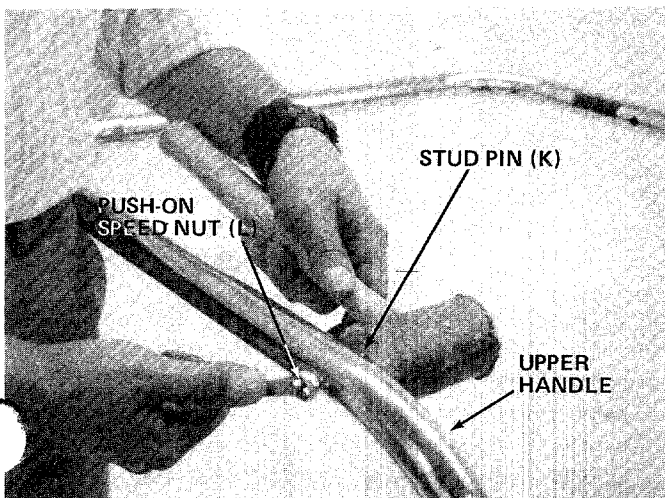

3. Place the stud pins (K) in holes in upper handle (head of pins go to the inside of handle). Secure pins with push-on speed nuts (L) by holding speed nut with box wrench and tapping pin with hammer. See figure 6.

FIGURE 6.

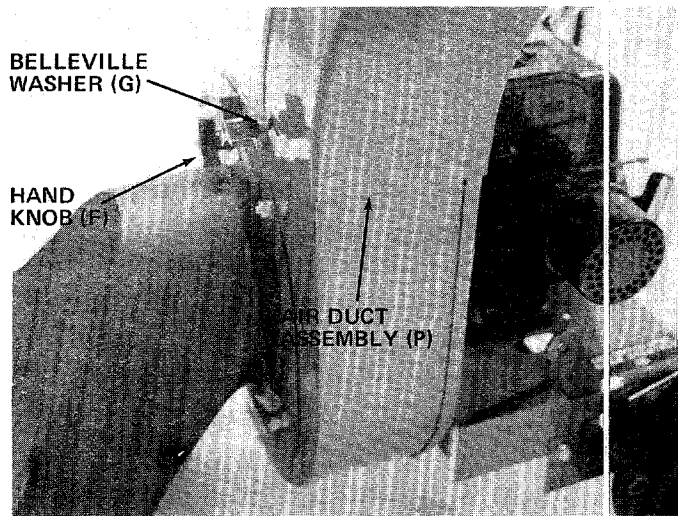

- Place air duct assembly (P) over opening on top of housing. Secure with two hand knobs (F) and belleville washer (G). See figure 7.

FIGURE 7.

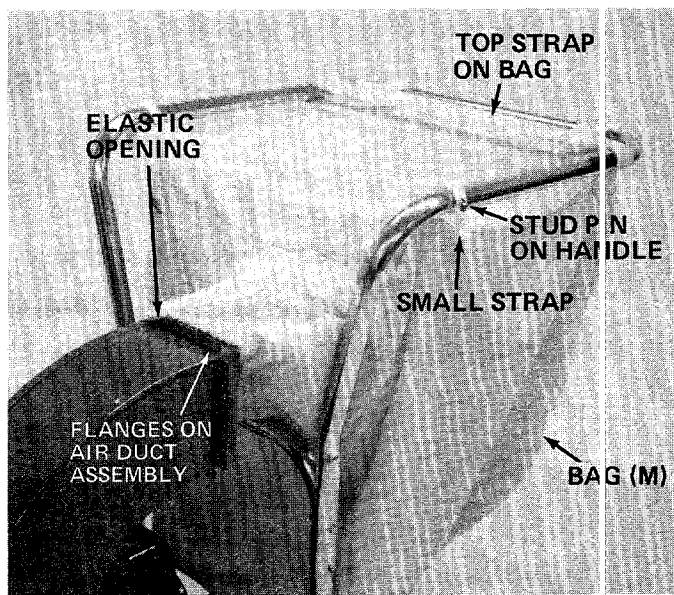

- Assemble the bag by slipping the top straps on bag (M) over upper handle. Hook two small straps over stud pins on handle. Slip elastic opening of bag over air duct assembly. See figure 8.



NOTE

Be certain elastic on bag is placed over the flanges on air duct assembly.

FIGURE 8.

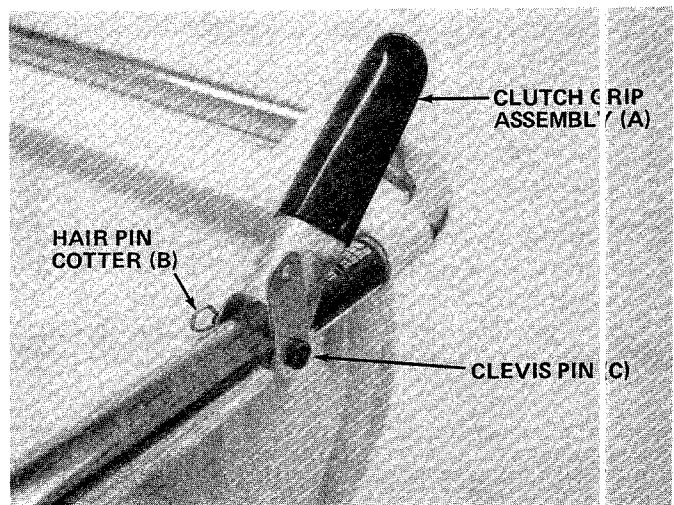

NOTE

Steps 6, 7 and 8 are for self-propelled units only.

- Assemble the clutch grip (A) to the left hand side of upper handle. Secure in place with clevis pin (C) and hair pin cotter (B). See figure 9. Head of clevis pin should be to the outside of handle.

FIGURE 9.

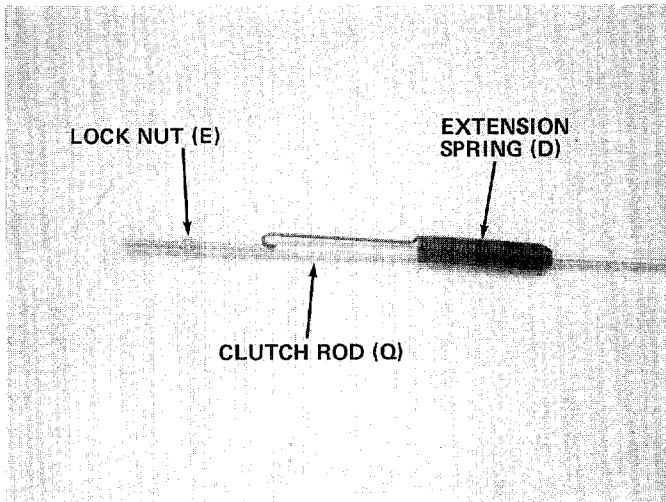

FIGURE 10.

7. Slide the extension spring (D) onto clutch rod (Q) as shown in figure 10. Thread lock nut (E) onto clutch rod approximately 2-1/2 inches.



FIGURE 11.

8. Hook top (hooked end) of clutch rod into clutch grip. Hook spring into clutch bracket assembly. See figure 11. Spring should not have any slack. Adjust nut so that when the clutch grip is all the way up, there is no slack in the spring.
9. Thread hex jam nut onto clutch rod, and lock it against the lock nut.

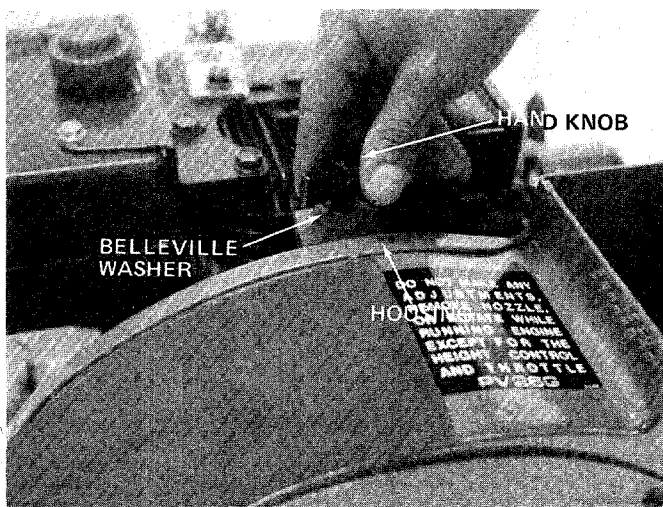

FIGURE 12.

ASSEMBLY INSTRUCTIONS

To Convert from a Vacuum to a Leaf Blower.



Engine must be stopped (off) and spark plug wire disconnected.

1. Remove the bag.
2. Remove the air duct assembly by removing two hand knobs and belleville washers.
3. Remove the nozzle by removing one hand knob and belleville washer.
4. Remove the hand knob and belleville washer holding the housing to engine brace. See figure 12.

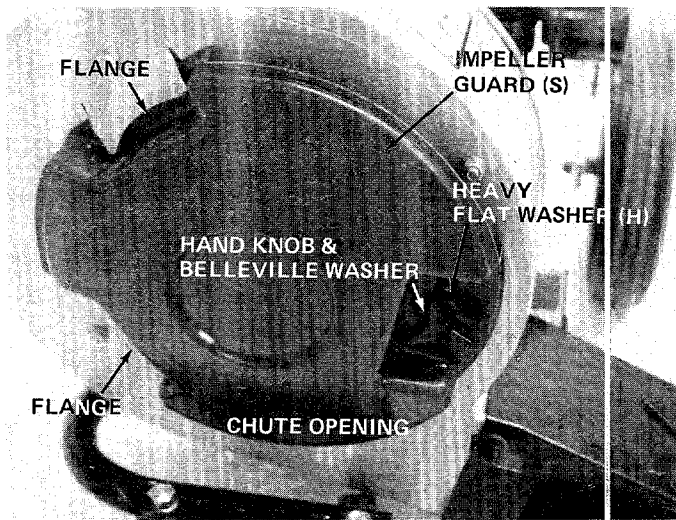

FIGURE 13

5. Lift up and out on the housing and rotate it 105° clockwise. Chute opening should be to the right hand side when viewed from the front of unit. See figure 13.
6. Place the impeller guard (S) into flanges on front of housing. Line up hole in screen with hole on housing. Secure with one hand knob, belleville washer and heavy flat washer (H). See figure 13.

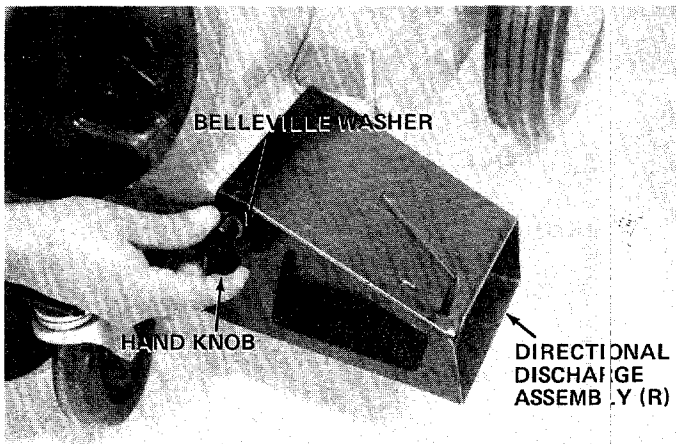

FIGURE 14

7. Place the directional discharge assembly (R) over chute opening. Secure with two hand knobs and belleville washers. See figure 14.

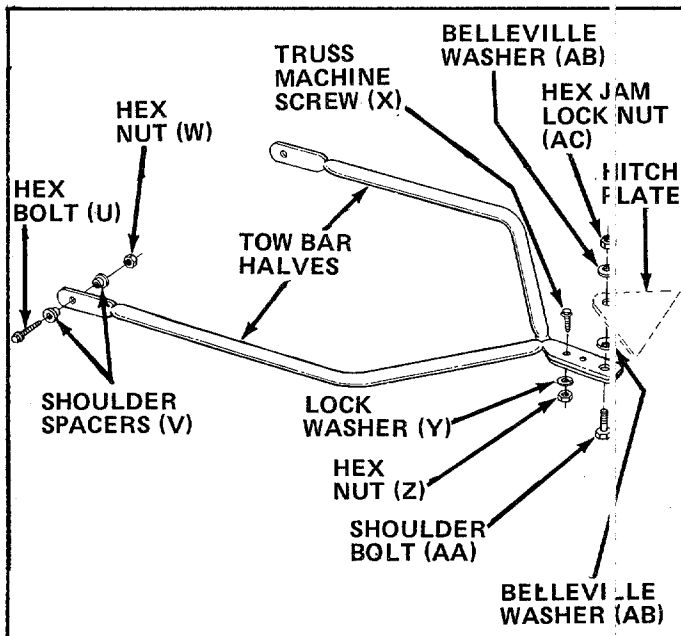

FIGURE 15

ASSEMBLY INSTRUCTIONS for Tow Bar Kit

1. Remove the self-tapping screws on each side of frame. Refer to drawing on page 12, reference number 42.
2. Place tow bar half in position on frame. Place one shoulder spacer (V) between frame and tow bar. Next, place shoulder spacer (V) and hex bolt (U) through tow bar and frame. Secure with hex nut (W). See figure 15. Repeat for other side.
3. Secure the two tow bar ends together with truss machine screws (X), lock washers (Y) and hex nuts (Z). See figure 15.

To attach the tow bar to a hitch, place the shoulder bolt (AA) up through the tow bar. Place one belleville washer (AB) on the shoulder bolt, then the hitch plate and the other belleville washer. Cupped side of the washers must be against the hitch plate. Secure with hex jam lock nut (AC). See figure 15.

OPERATION

PRE-START PREPARATIONS

Service engine with gas and oil. See engine manual packed with vacuum for complete instructions for care and maintenance of engine. READ DIRECTIONS CAREFULLY.

CAUTION
REVOLVING BLADES—KEEP
HANDS AWAY FROM ALL
OPENINGS

3450

TO START ENGINE

After the engine has been properly fueled and oiled (refer to engine operating and maintenance instructions), start engine following the instructions below.

1. Move throttle control lever on engine to START position.
2. Crank engine. Pull recoil with quick firm pull. Do not pull out so far the rope stops with a jerk as this will cause rope failure. Do not allow rope and handle to snap back into place.
3. After two or three full firm pulls on recoil (or as soon as engine fires), move speed control to RUN position.
4. **Self Propelled Models Only** - To engage the drive mechanism, squeeze the clutch grip against the upper handle. Release the clutch grip to stop the forward motion.

TO STOP ENGINE

1. To stop engine, move throttle control lever to STOP position.
2. Disconnect spark plug wire and ground to prevent accidental starting while equipment is unattended.

Operate a new engine at intermediate speeds and light load for the first few hours as you would a new automotive engine.

ADJUSTMENTS



CAUTION

Do not at any time make any adjustment to the unit without first stopping engine and disconnecting spark plug wire.

HEIGHT ADJUSTMENT

To adjust the height of the nozzle, stand on the right hand side of vacuum and move the index handle towards the engine. Move handle towards rear of unit to lower height. Move the handle forward to raise the height. See figure 16.

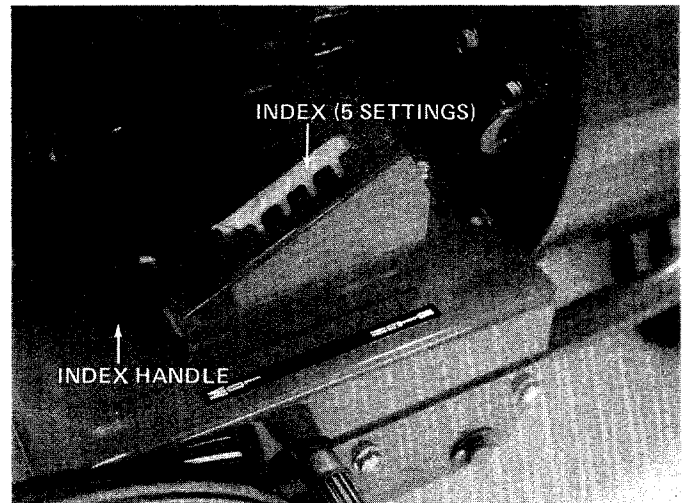

FIGURE 16

CARBURETOR ADJUSTMENT



WARNING

If any adjustments are made to the engine while the engine is running (e.g. carburetor), disengage all clutches. Keep clear of all moving parts. Be careful of heated surfaces and muffler.

If carburetor needs adjustment to start or for operation, see "Carburetor Adjustment" section of engine manual.

CLUTCH ROD ADJUSTMENT (Self Propelled Models Only)

To adjust the clutch rod, refer to step number 8 under assembly instructions.

LUBRICATION

Wheels - Rear wheels are provided with oil lite bearings. Place a few drops of SAE 30 oil on each bearing once a season.

Gear Box (Self Propelled Models Only) - The gear box lubricated with 2 ounces of High Temp. (45)° F.) grease. Order part number 727-0120. Periodically check lubricant level by removing the two self-tapping screws on the gear box cover and lifting off the cover. Do not change grease; simply add if necessary.

MAINTENANCE



WARNING

Disconnect spark plug wire and ground it against the engine before performing any repairs or maintenance.

BELT REPLACEMENT (Self Propelled Models Only)

1. Remove the nozzle or impeller guard from front of air duct housing.
2. Remove hex bolt and lock washer from center of impeller. See figure 17. A 9/16" socket wrench with extension is needed.
3. Remove hand knob and Belleville washer from top of housing.
4. Remove two self-tapping screws which hold the belt guard. See figure 18. A 3/8" wrench is required. Lift off belt guard.
5. Slide belt off the impeller pulley. Slide housing and impeller off engine crankshaft. Be careful to not lose square key. See figure 19.

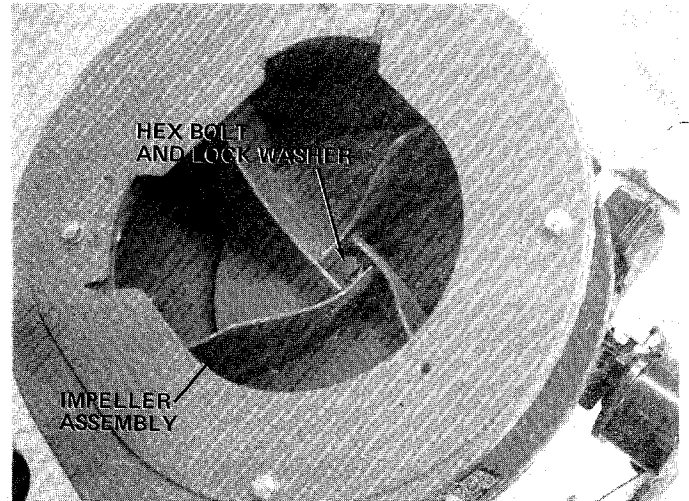

FIGURE 17

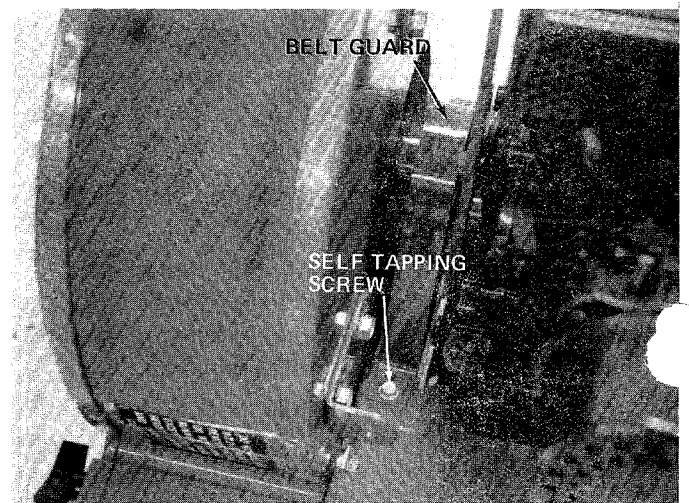

FIGURE 18

5. Slide belt off the impeller pulley. Slide housing and impeller off engine crankshaft. Be careful to not lose square key. See figure 19.

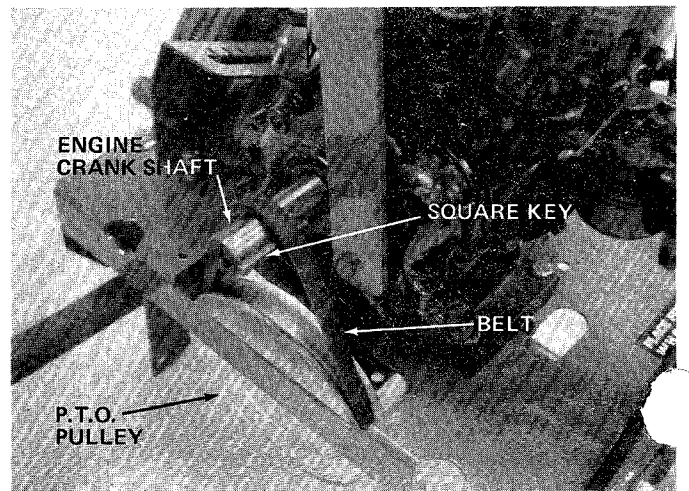

FIGURE 19

6. Slide belt off crank shaft.
7. Remove belt from P.T.O. pulley and install new belt. See figure 19.



When reassembling the new belt, the aid of another person will be helpful.

8. Turn the crankshaft until the key way on shaft is directly on top. While holding housing assembly and impeller assembly, line up the key way on the pulley with the key on the crankshaft, and slide housing and impeller assemblies onto crankshaft.
9. Secure impeller to crankshaft with hex bolt and lockwasher, removed in step 2. Tighten securely.
10. Slip belt over impeller pulley and reassemble the belt guard.
11. Reassemble the nozzle or impeller guard.

OFF-SEASON STORAGE

The following steps should be taken to prepare the unit for storage.

1. Clean the engine and the entire unit thoroughly.
2. Refer to engine manual for correct engine storage instructions.
3. Store unit in a clean, dry area.



When storing any type of power equipment in an unventilated or metal storage shed, care should be taken to rust proof the equipment. Using a light oil or silicone, coat the equipment, especially springs and bearings.

TROUBLE SHOOTING CHART

PROBLEM	CAUSE	REMEDY
1. Excessive vibration.	A. Bent crankshaft. B. Vane plate out of balance	A. Replace crankshaft (should be done by an authorized service dealer). B. Replace vane plate.
2. Height Adjustment slips out of lockout position.	A. Handle bent.	A. Replace index handle and index plate.
3. Engine Fails to Start.	A. Check fuel tank for gas. B. Spark plug lead wire disconnected. C. Faulty spark plug.	A. Fill tank if empty. B. Connect lead wire. C. Spark should jump gap between control electrode and side electrode. If spark does not jump, replace the spark plug.
4. Hard Starting or loss of power.	A. Spark plug wire loose. B. Dirty air cleaner.	A. Connect and tighten spark plug wire. B. Clean air cleaner as described in engine manual.
5. Engine Overheats.	A. Carburetor not adjusted properly. B. Air flow restricted. C. Engine oil level low.	A. Adjust carburetor. See engine manual. B. Remove blower housing on engine and clean as described in the engine manual. C. Fill crankcase with the proper oil.

OTE: For repairs beyond the minor adjustments listed above, please contact your local service dealer.

Models 675, 685 and 689

IF YOU WRITE TO US ABOUT THIS ARTICLE
OR IF YOU ORDER REPLACEMENT PARTS AL-
WAYS MENTION THIS MODEL & SERIAL NO
MODEL

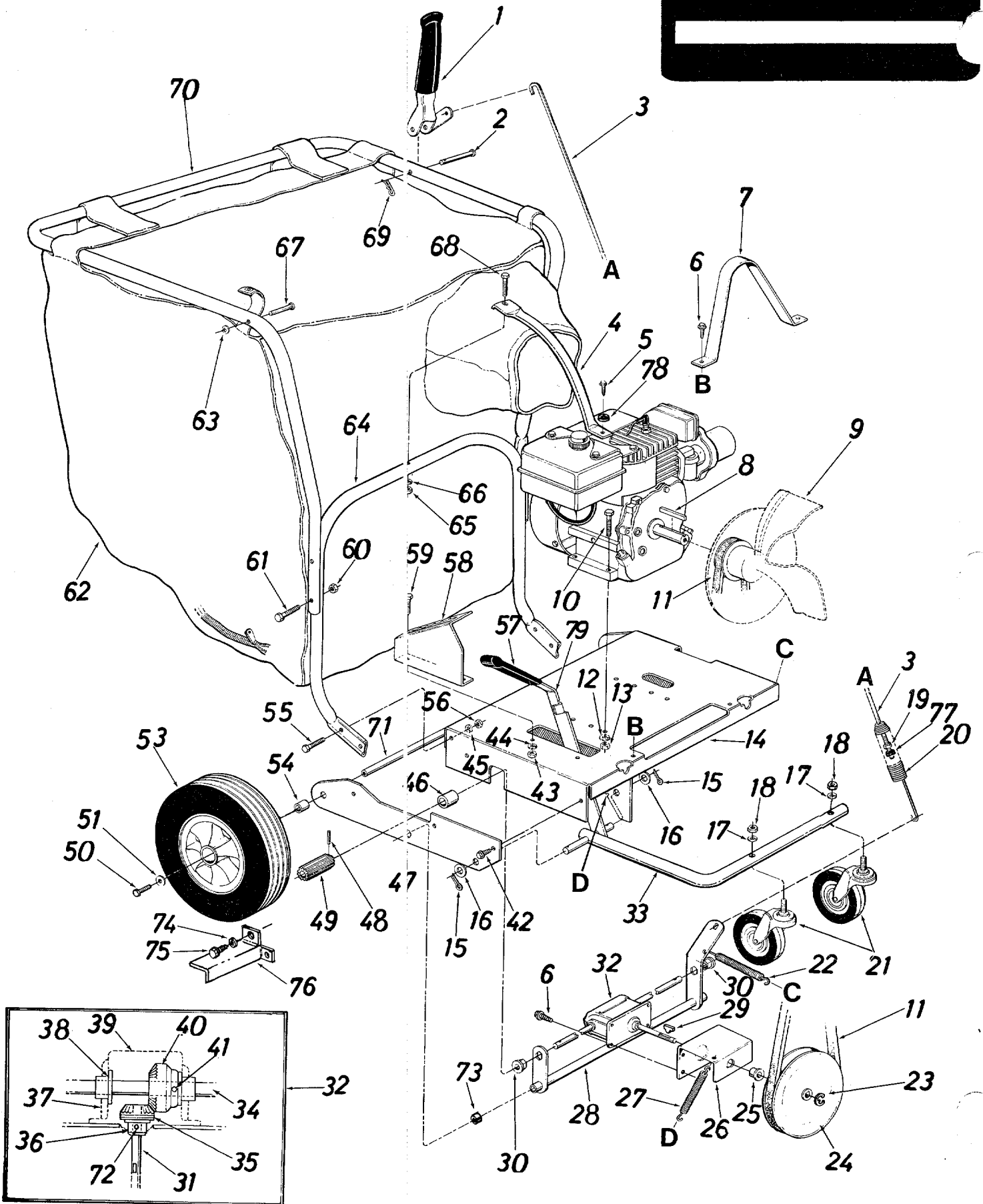

575/ 685/689

PARTS LIST FOR MODELS 675, 685, 689, 24677 and 24687 POWER VACUUMS

Ref. No.	Part No.	Color Code	Description	New Part	Ref. No.	Part No.	Color Code	Description	New Part
1	05778		Clutch Grip Ass'y. †		40	748-0135		Bevel Gear .62" I.D. x 28	
2	711-0679		Clevis Pin .375" Dia. x 1.88" Lg. †		41	715-0246		Teeth † Spring Pin Spiral 3/16" Dia. x 1.25" Lg. †	
3	747-0154		Clutch Rod 32" Lg. †		42	710-0726		Hex Wash. Hd. "AB" Tap Scr. 5/16" x .75" Lg.	
4	749-0482		Handle Brace (5 H.P.)		43	712-0267		Hex Nut 5/16-18 Thd.*	
	749-0484		Handle Brace (8 H.P.)		44	736-0119		L.-Wash. 5/16" I.D.*	
5	-----		Part of Engine		45	736-0119		L.-Wash. 5/16" I.D.*	
6	710-0776		Hex Wash. Hd. AB Tap Scr. 1/4" x .62" Lg. †		46	748-0201		Spacer .63 I.D. x .88" O.D. x .56" Lg. †	
7	14558		Belt Guard †		47	14530 --- 488		Side Plate	
8	714-0114		Square Key 1/4" x 1/4" x 2.00" Lg.		48	715-0139		Spring Pin Spiral 3/16" Dia. x .81" Lg. †	
9	14536 --- 488		Air Vane Plate Ass'y. (675 and 677)		49	748-0288		Drive Pinion †	
	14557 --- 488		Air Vane Plate Ass'y. w/pulley †		50	710-0170		Hex Locking Bolt 5/16-24 x .62" Lg.	
10	710-0442		Hex Bolt 5/16-18 x 1.50" Lg.*		51	736-0159		Fl.-Wash. .34" I.D. x 87" O.D.	
11	754-0219		"V"-Belt 1/2" x 26" Lg. †		53	734-1035		Wheel Ass'y. - Comp. 12" x 3" (Incl. Ball Bearings)	
12	736-0119		L.-Wash. 5/16" I.D.*			734-1044		Wheel Ass'y. Comp. 11" x 4" (677 Only)	
13	712-0267		Hex Nut 5/16-18 Thd.*			741-0313		Bearings (677 Only)	
14	14527 --- 488		Engine Mounting Frame Ass'y.		54	750-0194		Spacer .63" I.D. x 1.00" O.D. x .94" Lg.	
15	1544-009		Cotter Pin 5/32" Dia. x 1.25" Lg.*		55	710-0118		Hex Bolt 5/16-18 x .75" Lg.	
16	736-0187		Fl.-Wash. .63" I.D. x 1.25" O.D.		56	712-0267		Hex Nut 5/16-18 Thd.*	
17	736-0921		L.-Wash. 1/2" I.D.*		57	720-0142		Flat Grip Vinyl	
18	712-0206		Hex Nut 1/2-13 Thd.*		58	14561		Index Plate	
19	712-0107		Hex Cent. L.-Nut 1/4-20 Thd.		59	710-0118		Hex Bolt 5/16-18 x .75" Lg.*	
20	732-0411		Extension Spring .78" O.D. x 7.50" Lg. †		60	712-0107		Hex Cent. L.-Nut 1/4-20 Thd.	
21	734-1036		Swivel Caster Wheel 5" Dia. x 1.25"		61	710-0136		Hex Bolt 1/4-20 x 1.75" Lg.	
22	732-0409		Extension Spring .38" O.D. x 3.18" Lg. †		62	764-0162		Vacuum Bag - Felt	
23	716-0104		Snap "E"-Ring .50" Dia. Shaft †		63	1539-019		Push Speed Nut for .25" Dia. Stud	
24	756-0367		"V"-Pulley 5/8" x 6.50" O.D. †		64	749-0481		Lower Handle	
25	748-0142		Flange Bearing .502" I.D. †		65	712-0287		Hex Nut 1/4-20 Thd.*	
26	14570		Gear Box Mounting Bracket †		66	736-0329		L.-Wash. 1/4" I.D.*	
27	732-0376		Extension Spring .75" O.D. x 3.28" Lg. †		67	711-0737		Stud Pin .250" Dia. x 1.75" Lg.	
28	14565		Clutch Bracket Ass'y. †		68	710-0136		Hex Bolt 1/4-20 x 1.75" Lg.*	
29	714-0229		#2 Woodruff Key 3/32" Dia. x .81" Lg. †		69	714-0145		Internal Cotter Pin 3/8" Dia.	
30	748-0227		Hex Flange Bearing Bronze .625" I.D. †		70	749-0480		Upper Handle	
31	738-0516		Pinion Shaft .50" Dia. x 5.0" Lg. †		71	738-0185		Rear Axle .624" Dia. x 24.37" Lg.	
32	717-0493		Gear Box Ass'y. Comp. †		72	715-0249		Spring Roll Pin 5/32" Dia. x 1.12" †	
33	14571 --- 488		Caster Arm Ass'y.		73	750-0142		Spacer .82" I.D. x 1.00" O.D. x .305 Lg. †	
34	08348		Drive Shaft .624" Dia. x 22.75" Lg. †		74	736-0175		L.-Wash. .265" I.D. †	
35	748-0136		Bevel Gear .50" I.D. x 14 Teeth †		75	710-0352		Hex Self Tap Scr. 1/4" x 3/8" Lg. †	
36	748-0108		Flange Bearing .503" I.D. †		76	14556		R.H. Pinion Guard †	
37	08189		Gear Box †			14555		L.H. Pinion Guard (Not Shown)	
38	748-0110		Flange Bearing .630" I.D. †		77	712-0298		Hex Jam Nut 1/4-20 Thd. †	
39	08187		Gear Box Cover †		78	736-0242		Belleville Washer	
					79	14552		Height Adj. Handle	

Models 675, 685 and 689

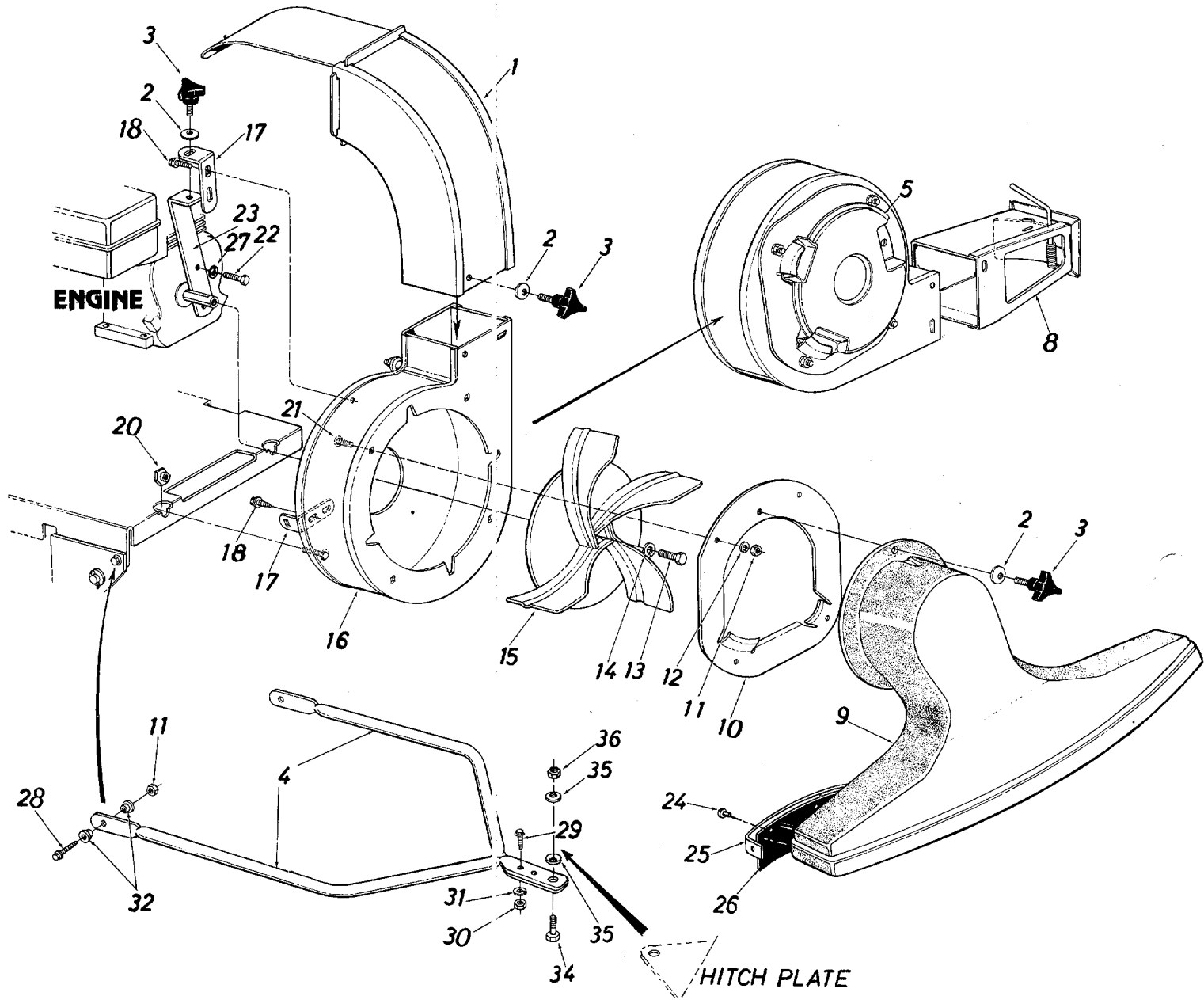

Models 675, 685 and 689

PARTS LIST FOR MODELS 675, 685, 689, 24677 and 24687 POWER VACUUMS

Ref. No.	Part No.	Color Code	Description	New Part
1	14532 --- 488		Air Duct Assembly	
2	736-0242		Belleville Wash. 34" I.D. x .87" O.D.	
3	720-0170		3-Arm Thumb Scr. 5/16-18 x .75" Lg.	
4	749-0501		Tow Bar Half	
5	731-0608		Blower Guard	
8	14479		Directional Discharge Ass'y.	
9	14562		Nozzle Ass'y.	
10	14563		Nozzle Plate Ass'y.	
11	712-0267		Hex Nut 5/16-18 Thd.*	
12	736-0119		L.-Wash. 5/16" I.D.	
13	710-0191		Hex Bolt 3/8-24 x 1.25" Lg.*	
14	736-0217		L.-Wash. 3/8" I.D. H.D.	
15	14536 --- 488		Air Vane Plate Ass'y. (675 and 24677)	
	14557 --- 488		Air Vane Plate Ass'y. w/pulley (685, 689 and 24687)	
16	14496 --- 488		Blower Housing Complete	
17	14541		Right Angle Bracket	
18	710-0600		Hex Wash. Hd. Self Tap Scr. 5/16-18 x .50" Lg.	
20	711-0758		Hex Shoulder Nut .50 I.D.	
21	710-0260		Carriage Bolt 5/16-18 x .62" Lg.*	
22	710-0627		Hex Locking Bolt 5/16-24 x .75" Lg.	
23	14539		Housing - Engine Brace Ass'y.	
24	728-0143		Pop Rivet (5-Required)	
25	14569		Wiper Retaining Strip	
26	735-0214		Nozzle Wiper	
27	736-0271		L.-Wash. 5/16" I.D.	
28	710-0602		Hex Bolt 5/16-18 x 1.00" Lg.*	
29	710-0255		Truss Mach. Scr. 1/4-20 x .75" Lg.*	
30	712-0287		Hex Nut 1/4-20 Thd.*	
31	736-0329		L.-Wash. 1/4" I.D.*	
32	748-0234		Shoulder Spacer	
34	738-0143		Shld. Bolt .496 Dia.	
35	736-0219		Belleville Wash. .39 I.D. x 1.12 O.D.	
36	712-0181		Hex Jam L-Nut 3/8-16 Thd.	

*For faster service obtain standard nuts, bolts and washers locally. If these items cannot be obtained locally, order by part number and size as shown on parts list.

(488 - Mack Truck Yellow)
(497 - Yard-Man Red)

When ordering parts, if color or finish is important use the appropriate color code shown above. (e.g. Mack Truck Yellow Finish—14542 (488)).

NOTE: The engine is not under warranty by the vacuum manufacturer... If repairs or service is needed on the engine, please contact your nearest authorized engine service outlet. Check the "Yellow Pages" of your telephone book under "Engines—Gasoline."



NOTE

This instruction manual covers various models and all specifications shown do not necessarily apply to your model. Specifications subject to change without notice or obligation.

PARTS INFORMATION

POWER EQUIPMENT PARTS AND SERVICE

Parts and service are available through the authorized service firms listed below. All orders should specify the model number of your unit, part numbers, description of parts and the quantity of each part required.

BRIGGS AND STRATTON, TECUMSEH AND PEERLESS PARTS AND SERVICE

Briggs & Stratton, Tecumseh and Peerless parts and service should be handled by your nearest authorized engine service firm. Check the yellow pages of your telephone directory under the listing **Engines—Gasoline**, Briggs & Stratton or Tecumseh Lauson.

NOTE: If any parts are found to be missing or defective upon assembly of this unit, write to advise the factory so that immediate replacement can be made.

ALABAMA Auto Electric & Carburetor Co.	BIRMINGHAM 2625 4th Ave. S.	35233	NORTH CAROLINA Smith Hardware Co.	GOLDSBORO 515 N. George St.	27530
ARKANSAS Sutton's Lawn Mower Shop	NORTH LITTLE ROCK 5301 Roundtop Drive Box 368, Rt. 4	72117	Dixie Sales Company	GREENSBORO 335 N. Green	27402
CALIFORNIA Billious	PORTERVILLE 75 North D Street	93257	OHIO Stebe's Mid-State Mower Supply	CARROLL Box 366, 71 High St.	43112
COLORADO Spitzer Industrial Products Co.	DENVER 6601 N. Washington St.	80229	Bleckrie, Inc.	CLEVELAND 7900 Lorain Ave.	44102
FLORIDA Radco Distributors	JACKSONVILLE 4909 Victor St. Box 5459	32207	National Central	WADSWORTH 687 Seville Rd.	44281
Small Eng. Dist.	OPA LOCKA 2351 N.W. 147th St.	33054	Burton Supply Co.	YOUNGSTOWN 1301 Logan Ave. Box 929	44501
GEORGIA East Point Cycle & Key	EAST POINT 2834 Church St.	30344	OKLAHOMA Victory Motors, Inc.	MUSKOGEE 605 S. Cherokee	74401
ILLINOIS Keen Edge Co.	LYONS 8615 Ogden Ave.	60534	OREGON Kenton Supply Co.	PORTLAND 8216 N. Denver Ave.	97217
INDIANA Parts & Sales Inc.	ELKHART 2101 Industrial Pkwy.	46516	PENNSYLVANIA EECO Inc.	HARRISBURG 4021 N. 6th St.	17110
IOWA Power Lawn & Garden Equip.	DUBUQUE 2551 J.F. Kennedy	52001	Thompson Rubber Co.	PHILADELPHIA 5222-24 N. Fifth St.	19120
LOUISIANA Mid-South Power	MONROE 1500 Arkansas St.	71201	Bluemont Co.	PITTSBURGH 11125 Frankstown Rd.	15235
Suhren Engine Co.	NEW ORLEANS 8330 Earhart Blvd.	70118	Frank Roberts & Sons	PUNXSUTAWNEY R.D. 2	15767
MARYLAND Center Supply Co.	TAKOMA PARK 6867 New Hampshire Ave.	20912	Scranton Auto Ignition Co.	SCRANTON 1133-35 Wyoming Ave.	18509
MASSACHUSETTS Morton B. Collins Co.	SPRINGFIELD 300 Birnie Ave.	01107	TENNESSEE Master Repair Service	KNOXVILLE 2000 Western Ave.	37921
MICHIGAN Lorenz Service Co.	LANSING 2500 S. Pennsylvania	48910	American Sales & Service, Inc.	MEMPHIS 3035-43 Bellbrook	38116
Power Equipment Dist.	MOUNT CLEMENS 340 Hubbard	48043	TEXAS Marr Brothers, Inc.	DALLAS 423 E. Jefferson	75203
MINNESOTA Hance Distributing Inc.	HOPKINS 420 Excelsior Ave. W.	55343	Woodson Sales Corp.	FORT WORTH 1702 N. Sylvania	76111
MISSISSIPPI Biloxi Sales & Service, Inc.	BILOXI 506 Caillavet St.	39533	Bullard Supply Co.	HOUSTON 2409 Commerce St.	77003
MISSOURI Automotive Equip. Service	KANSAS CITY 3117 Holmes St.	64109	Engine House Inc.	SAN ANTONIO 8610 Botts Lane P.O. Box 17867	78217
Ross-Frazier Supply Co.	ST. JOSEPH 8th and Monterey	64503	UTAH A-1 Engine & Mower Co.	SALT LAKE CITY 439 E. 900 So.	84111
Henzler, Inc.	ST. LOUIS 2015 Lemay Ferry Rd.	63125	VIRGINIA RBI Corp.	ASHLAND 101 Cedar Run Dr.	23005
NEW JERSEY Lawnmower Parts Inc.	BELLMAWR 717 Creek Rd.	08030	WASHINGTON Bailey's Inc.	SEATTLE 1414 14th Ave.	98122
NEW MEXICO Spitzer Eng. & Parts	ALBUQUERQUE 1023 Third Ave. N.W.	87103	WISCONSIN Automotive Supply Co.	APPLETON 123 S. Linwood Ave. P.O. Box 798	54911
NEW YORK Gamble Dist., Inc.	CARTHAGE West End Ave.	13619	Horst Dist.	CHILTON 444 N. Madison	53014
Red Fox Parts Dist.	SCHOHARIE Rt. 30 P.O. Box 527	12157			

WARRANTY PARTS AND SERVICE POLICY

(0483)

The purpose of warranty is to protect the customer from defects in workmanship and materials, defects which are NOT detected at the time of manufacture. It does not provide for the unlimited and unrestricted replacement of parts. Use and maintenance are the responsibility of the customer. The manufacturer cannot assume responsibility for conditions over which it has no control. Simply put, if it's the manufacturer's fault, it's the manufacturer's responsibility; if it's the customer's fault, it's the customer's responsibility.

CLAIMS AGAINST THE MANUFACTURER'S WARRANTY INCLUDES:

1. Replacement of Missing Parts on new equipment.
2. Replacement of Defective Parts within the warranty period.
3. Repair of Defects within the warranty period.

All claims MUST be substantiated with the following information:

1. Model Number of unit involved.
2. Date unit was purchased or first put into service.
3. Date of failure.
4. Nature of failure.