

TUMBLE ACTION WASHER

Use & Care Guide

MACHINE À LAVER PAR CULBUTAGE

Guide de L'utilisateur

LAVADORA CON TAMBOREACCIÓN

Manual de Uso & Mantenimiento

Contents

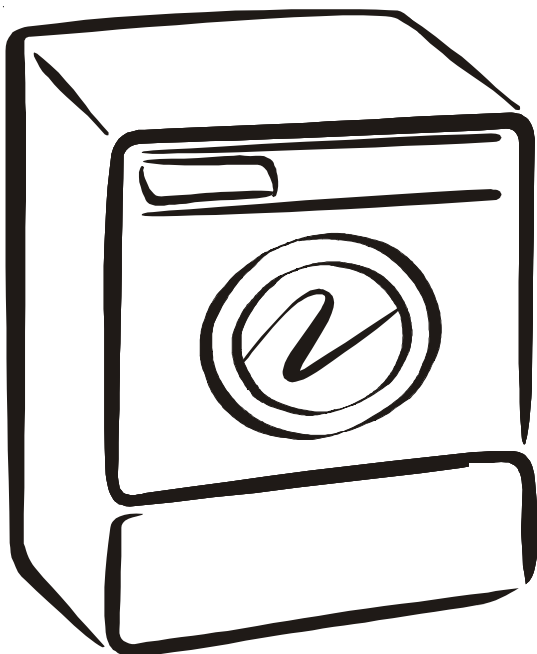

Important Safety Instructions.....	2
Washing Procedures.....	3-5
Stain Removal.....	5-6
Common Washing Problems.....	7
Care and Cleaning.....	8
Avoid Service Checklist.....	9
Warranty.....	10
Français.....	11-20
Consignes de sécurité importantes.....	11
Instructions de lavage.....	12-14
Détachage.....	14-15
Problèmes de lessive courants.....	16
Entretien et nettoyage.....	17-18
Guide de dépannage.....	18-19
Garantie.....	20
Español.....	21-29
Instrucciones importantes para la seguridad.....	21
Procedimientos para el lavado.....	22-24
Eliminación de manchas.....	24-25
Problemas comunes del lavado.....	26
Cuidado y limpieza.....	27
Lista de comprobación para evitar el servicio.....	28
Garantía.....	29
Back Cover.....	32

Product Registration

Thank you for choosing this washer. This owner's guide will explain proper operation and care.

Register Your Product

The self-addressed **PRODUCT REGISTRATION CARD** should be filled in completely, signed and returned.

Enregistrement du produit

Merci d'avoir choisi cette laveuse. Le présent Guide de l'utilisateur décrit les normes d'utilisation et d'entretien du produit.

Enregistrer le produit

La **CARTE D'ENREGISTREMENT** préalablement adressée doit être remplie en entier, signée et retournée.

Registro del Producto

Le agradecemos que haya seleccionado esta lavadora. En este manual del usuario encontrará las instrucciones apropiadas para su funcionamiento y cuidado.

Registre su Producto

La **TARJETA DE REGISTRO DEL PRODUCTO** ya dirigida debe ser llenada, firmada y enviada.

Read and Save These Instructions

Record Your Model and Serial Numbers

The model and serial numbers of your washer are found on the washer serial plate located at the top, inside of the door opening. Record and retain these numbers.

Lisez et conservez ces instructions

Le numéro de modèle et de série de votre machine à laver par culbutage se trouve, sur la plaque signalétique située sur la partie supérieure de la contre-porte. Notez et conservez ces numéros.

Anote su Número de Modelo y de Serie

Anote a continuación el número de modelo y de serie que se encuentran en la placa de serie situada en el interior de la puerta de la lavadora. Conserve estos números para referencia futura.

Model Number:

Número de Modelo:

Numéro de modèle: _____

Serial Number:

Número de Serie:

Numéro de série: _____

Purchase Date:

Fecha de compra:

Date d'achat: _____

Read all instructions before using this washer.

⚠ WARNING To reduce the risk of fire, electrical shock, or injury to persons when using this washer, comply with the basic warnings listed below.

⚠ Failure to comply with these warnings could result in serious personal injuries.

Prevent Fire

⚠ WARNING Do not wash items that have been previously cleaned in, soaked in, or spotted with gasoline, cleaning solvents, kerosene, cooking oils, waxes, etc. Do not store these items on or near the washer. These substances give off vapors or chemical reactions that could ignite or explode.

WA

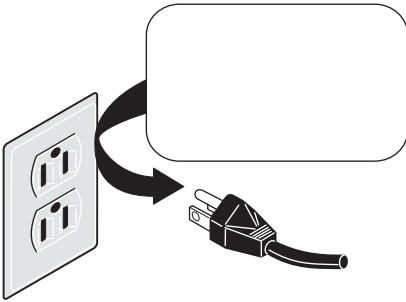

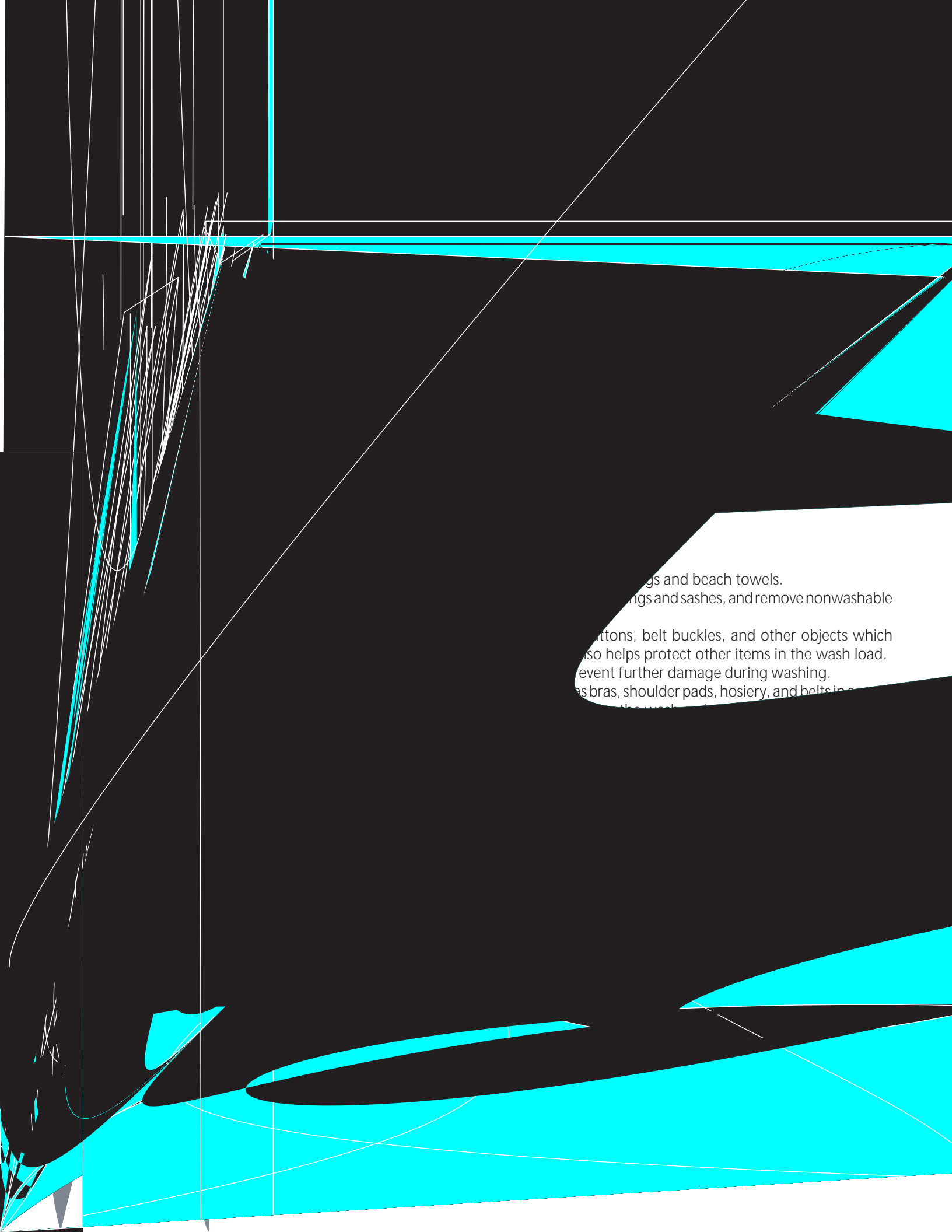

...ngs and beach towels.
...ngs and sashes, and remove nonwashable
...uttons, belt buckles, and other objects which
...so helps protect other items in the wash load.
...event further damage during washing.
...as bras, shoulder pads, hosiery, and belts in a

Washing Procedures (continued)

6. Set cycle type, size, and temperature. (See page 10 for details.)

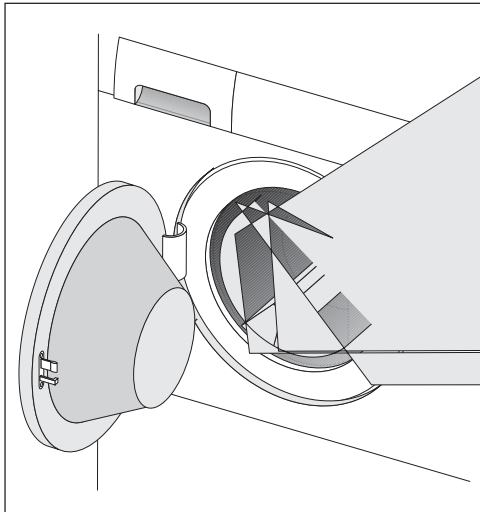

the desired setting. Pull out the knob to restart the washer.

- To open the door during a spin cycle, push in the cycle selector knob. The Door Lock indicator light will turn off. Wait 1-2 minutes for the lock to release. The door can then be opened. Do not force open the locked door.



Do not store or place laundry products on top of washer at any time. They can damage the finish or controls.

8. Remove items when the cycle is completed.

Place washed items in automatic dryer, line dry, or dry flat as directed by fabric care label. Excess wrinkling, color transfer or odors may develop in items left in the washer after the cycle has ended.

9. General Precautions

- **Dispenser drawer should be closed completely during operation.**
- **Do not slam the washer door closed or try to force the door open when locked (Door Lock light ON).** This could result in damage to the washer.
- **DO NOT leave the washer door open.** An open door could entice children to hang on the door or crawl inside the washer.
- To avoid damaging the washer and personal injury, **DO NOT** hang on or lean against the washer door.
- Do not place detergent, bleach or fabric softener containers on top of the washer. They can damage the finish or controls.

Stain Removal

⚠ WARNING Do not use or mix liquid chlorine bleach with other household chemicals such as toilet cleaners, rust removers, acid or products containing ammonia. These mixtures can produce dangerous fumes which can cause serious injury or death.

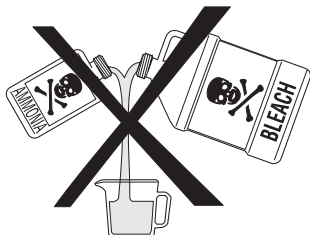

Safe Stain Removal Procedures

⚠ WARNING To reduce the risk of fire or serious injury to persons or property, comply with the basic warnings listed below:

- Read and comply with all instructions on stain removal products.
- Keep stain removal products in their original labeled containers and out of children's reach.
- Thoroughly wash any utensil used.
- Do not combine stain removal products, especially ammonia and chlorine bleach. Dangerous fumes may result.
- Never wash items which have been previously cleaned in, washed in, soaked in or spotted with gasoline, dry cleaning solvents or other flammable or explosive substances because they give off vapors that could ignite or explode.
- Never use highly flammable solvents, such as gasoline, inside the home. Vapors can explode on contact with flames or sparks.

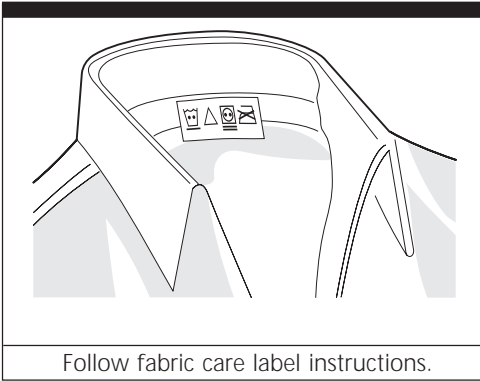

For successful stain removal:

- Remove stains promptly.
- Determine the kind of stain, then follow the recommended treatment in the stain removal chart below.
- To pretreat stains, use a prewash product, liquid detergent, or a paste made from granular detergent and water.
- Use cold water on unknown stains because hot water can set stains.
- Check care label instructions for treatments to avoid on specific fabrics.
- Check for colorfastness by testing stain remover on an inside seam.
- Rinse and wash items after stain removal.

Stain Removal	
STAIN	TREATMENT
Adhesive tape, chewing gum, rubber cement	Apply ice. Scrape off excess. Place stain face down on paper towels. Saturate with prewash stain remover or nonflammable dry cleaning fluid.
Baby formula, dairy products, egg	Use product containing enzymes to pretreat or soak stains. Soak for 30 minutes or more. Wash.
Beverages (coffee, tea, soda, juice, alcoholic beverages)	Pretreat stain. Wash using cold water and bleach safe for fabric.
Blood	Rinse with cold water. Rub with bar soap. Or, pretreat or soak with product containing enzymes. Wash using bleach safe for fabric.
Candle wax, crayon	Scrape off surface wax. Place stain face down between paper towels. Press with warm iron until wax is absorbed. Replace paper towels frequently. Treat remaining stain with prewash stain remover or nonflammable dry cleaning fluid. Hand wash to remove solvent. Wash using bleach safe for fabric.
Chocolate	Pretreat or soak in warm water using product containing enzymes. Wash using bleach safe for fabric.
Collar or cuff soil, cosmetics	Pretreat with prewash stain remover or rub with bar soap.
Dye transfer on white fabric	Use packaged color remover. Wash using bleach safe for fabric.
Grass	Pretreat or soak in warm water using product containing enzymes. Wash using bleach safe for fabric.
Grease, oil, tar (butter, fats, salad dressing, cooking oils, car grease, motor oils)	Scrape residue from fabric. Pretreat. Wash using hottest water safe for fabric. For heavy stains and tar, apply nonflammable dry cleaning fluid to back of stain. Replace towels under stain frequently. Rinse thoroughly. Wash using hottest water safe for fabric.
Ink	Some inks may be impossible to remove. Washing may set some inks. Use prewash stain remover, denatured alcohol or nonflammable dry cleaning fluid.
Mildew, scorch	Wash with chlorine bleach if safe for fabric. Or, soak in oxygen bleach and hot water before washing. Badly mildewed fabrics may be permanently damaged.
Mud	Brush off dry mud. Pretreat or soak with product containing enzymes.
Mustard, tomato	Pretreat with prewash stain remover. Wash using bleach safe for fabric.
Nail polish	May be impossible to remove. Place stain face down on paper towels. Apply nail polish remover to back of stain. Repeat, replacing paper towels frequently. Do not use on acetate fabrics.
Paint, varnish	WATER BASED: Rinse fabric in cool water while stain is wet. Wash. Once paint is dry, it cannot be removed. OIL BASED AND VARNISH: Use solvent recommended on can label. Rinse thoroughly before washing.
Perspiration	Use prewash stain remover or rub with bar soap. Rinse. Wash using nonchlorine bleach in hottest water safe for fabric.
Rust, brown or yellow discoloration	For spots, use rust remover safe for fabric. For discoloration of an entire load, use phosphate detergent and nonchlorine bleach. Do not use chlorine bleach because it may intensify discoloration.
Shoe polish	LIQUID: Pretreat with a paste of granular detergent and water. PASTE: Scrape residue from fabric. Pretreat with prewash stain remover or nonflammable dry cleaning fluid. Rinse. Rub detergent into dampened area. Wash using bleach safe for fabric.
Urine, vomit, mucus, feces	Pretreat or soak in product containing enzymes. Wash using bleach safe for fabric.

Common Washing Problems

Many washing problems involve poor soil and stain removal, residues of lint and scum, and fabric damage. For satisfactory washing results, follow these suggestions provided by The Soap and Detergent Association.

PROBLEM	POSSIBLE CAUSES	SOLUTIONS	PREVENTIVE MEASURES
Blue stains	<ul style="list-style-type: none"> •Undiluted liquid detergent or fabric softener dispensed directly onto fabric. 	<ul style="list-style-type: none"> •If caused by detergent, mix 1 cup (240 ml) white vinegar with 1 quart (.95 L) water in a plastic container. Soak item 1 hour. Rinse. •If caused by fabric softener, rub stains with bar soap. Wash. 	<ul style="list-style-type: none"> •Avoid overfilling detergent and fabric softener compartments of dispenser.
Discoloration, graying	<ul style="list-style-type: none"> •Not enough detergent. •Wash water temperature too low. •Incorrect sorting. 	<ul style="list-style-type: none"> •Rewash with correct amount of detergent and hottest water safe for fabric. Add bleach safe for fabric. 	<ul style="list-style-type: none"> •Sort items by soil level and color. •Use correct amount of detergent, hottest water and bleach safe for fabric.
Greasy, oily stains	<ul style="list-style-type: none"> •Not enough detergent. •Undiluted liquid fabric softener poured directly on fabric. 	<ul style="list-style-type: none"> •Treat with prewash stain remover or liquid detergent. •Increase detergent and water temperature. Rewash. •Rub fabric softener stains with bar soap. 	<ul style="list-style-type: none"> •Use correct amount of detergent and hottest water safe for fabric. •Do not pour liquid fabric softener directly on fabric. See Washing Procedures for directions on adding softener.
Holes, tears, or snags	<ul style="list-style-type: none"> •Incorrect use of chlorine bleach. •Unfastened zippers, hooks, buckles. •Rips, tears and broken threads. Overloading the washer. •Degradation of fabric. 	<ul style="list-style-type: none"> •May be irreversible if rips, tears and seams cannot be mended. 	<ul style="list-style-type: none"> •Never pour chlorine bleach directly on fabric. •Check condition of items before washing. See Washing Procedures for preparing and loading the wash load and adding chlorine bleach.
Lint	<ul style="list-style-type: none"> •Incorrect sorting. •Tissues left in pocket. •Overloading the washer. •Not enough detergent. •Undissolved detergent has left a residue resembling lint. •Static cling is attracting lint. •Load washed too long. 	<ul style="list-style-type: none"> •Reduce load size. Rewash using correct water temperature, water level, and amount of detergent. •Add nonprecipitating water conditioner to wash water to remove detergent residue. •Add liquid fabric softener to final rinse. •Dry load in dryer. •Remove lint with lint brush or roller. 	<ul style="list-style-type: none"> •See Washing Procedures for sorting and preparing the wash load. •Do not overload washer. •Use correct temperature and amount of detergent, water and wash time.
Pilling (Fibers break off, ball up and cling to fabric.)	<ul style="list-style-type: none"> •Pilling is normal with synthetic and permanent press fabrics. This is due to abrasion from normal wear. 	<ul style="list-style-type: none"> •Use a lint brush or shaver to remove pills. 	<ul style="list-style-type: none"> •Use fabric softener in the washer to lubricate fibers. •When ironing, use spray starch or fabric finish on collars and cuffs. •Turn items inside out to reduce abrasion.
Residue or powder on dark items; Stiff, harsh fabrics.	<ul style="list-style-type: none"> •Undissolved detergent. •Some nonphosphate granular detergents can combine with hard water minerals to form a residue. •Overloading the washer. 	<ul style="list-style-type: none"> •Rewash load. 	<ul style="list-style-type: none"> •Increase water temperature using hottest water safe for fabric. •Do not overload washer. •Use liquid detergent or use nonprecipitating water conditioner with nonphosphate granular detergent.
Wrinkling	<ul style="list-style-type: none"> •Overloading the washer. •Incorrect wash cycle for wash load. 	<ul style="list-style-type: none"> •Reduce load size. •Rinse in cold water with liquid fabric softener using the Perm Press or Delicate cycle. 	<ul style="list-style-type: none"> •Do not overload washer. •Remove items from washer as soon as cycle is completed. •Use liquid fabric softener.
Yellow buildup of body soil on synthetic fabrics	<ul style="list-style-type: none"> •Agitation time too short. •Wash water temperature too low. •Not enough detergent. 	<ul style="list-style-type: none"> •Soak in detergent booster or product containing enzymes. •Wash in hot water (120°F/49°C) using full permanent press cycle. Increase detergent. Add bleach safe for fabric. •Or, treat with color remover. 	<ul style="list-style-type: none"> •Select correct wash cycle. •Use correct amount of detergent. •Wash synthetics frequently using hot or warm water.
Yellow or brown rust stains	<ul style="list-style-type: none"> •Iron or manganese in water supply, water pipes, or water heater. 	<ul style="list-style-type: none"> •To restore discolored load of whites, use rust remover safe for fabric. •Do not use chlorine bleach to remove rust stains. It may intensify discoloration. 	<ul style="list-style-type: none"> •Use nonprecipitating water softener. •Before washing, run hot water for a few minutes to clear lines. •Drain water heater occasionally. •For an ongoing problem, install an iron filter in your water supply system.

Care and Cleaning

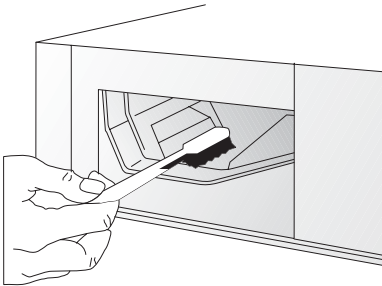

Avoid Service Checklist

Before calling for service, review this list. It may save both time and expense. The list includes common concerns that are not the result of defective workmanship or materials in this washer.

OCCURRENCE	POSSIBLE CAUSE / SOLUTION
NOISE	
"Clicking" noise.	<ul style="list-style-type: none"> A normal sound made by the timer.
High pitch "jet engine" noise.	<ul style="list-style-type: none"> A certain amount of motor whine is normal during the spin cycle.
Rattling and clanking noise.	<ul style="list-style-type: none"> Foreign objects such as coins or safety pins may be in drum or pump. Stop washer and check drum. If noise continues after washer is restarted, objects may be in pump. Call your authorized servicer. Belt buckles and metal fasteners are hitting wash drum. To prevent unnecessary noise and damage to drum, fasten fasteners and turn items inside out.
Squealing sound or hot rubber odor.	<ul style="list-style-type: none"> Washer is overloaded. Do not overload washer. Stop washer and reduce load.
Thumping sound.	<ul style="list-style-type: none"> Heavy wash loads may produce a thumping sound. This is usually normal. If sound continues, washer is probably out of balance. Stop washer and redistribute wash load.
Vibrating noise.	<ul style="list-style-type: none"> Washer is not resting firmly on floor. Move washer so it rests firmly on floor. Adjust leveling legs and tighten lock nuts. See INSTALLATION INSTRUCTIONS for details. Shipping bolts and foam block have not been removed during installation. See INSTALLATION INSTRUCTIONS for removing shipping bolts and foam block. Wash load unevenly distributed in drum. Stop washer and rearrange wash load.
OPERATING	
Washer does not start.	<ul style="list-style-type: none"> Electrical power cord may not be plugged in or connection may be loose. Make sure plug fits tightly in wall outlet. House fuse blown, circuit breaker tripped, or a power outage has occurred. Reset circuit breaker or replace fuse. Do not increase fuse capacity. If problem is a circuit overload, have it corrected by a qualified electrician. If problem is a power outage, call local electric company. Water supply faucets are not turned on. Turn on water supply faucets. Cycle selector is not in correct position. Move indicator clockwise slightly. Pull out knob. Motor is overheated. Washer motor will stop if it becomes overheated. It will automatically restart after a cool down period of up to 30 minutes (if washer has not been manually turned off). Washer door is not completely closed. Close door completely.
Washer won't spin.	<ul style="list-style-type: none"> Load is too small. Add 1 or 2 similar items to help balance the load.
Residue left in drum.	<ul style="list-style-type: none"> Heavily soiled items. Wipe drum with a nonabrasive household cleanser, then rinse. Shake or brush excess dirt and sand from items before washing.
Laundry additives didn't dispense.	<ul style="list-style-type: none"> Dispenser drawer open. Drawer should be completely closed for laundry additive to dispense.
WATER	
Water collects in bleach and fabric softener compartments.	<ul style="list-style-type: none"> This is a result of the siphoning action and is part of the normal operation of the washer. Water may be removed by removing the dispenser drawer (see Page 8, Figures 1 and 2) and draining water into the empty drum or sink.
Wash load too wet after spin.	<ul style="list-style-type: none"> Washer is overloaded. Do not overload washer. See Washing Procedures. Load is too small. Add 1 or 2 similar items to help balance the load. Load is out of balance. Rearrange load to allow proper spinning.
Water does not enter washer or it enters slowly.	<ul style="list-style-type: none"> Drain hose is kinked. Straighten drain hose. Water supply is not adequate in area. Check another faucet in the house. Wait until water supply and pressure increase. Water supply faucets are not completely open. Fully open hot and cold faucets. Water is being used elsewhere in the house. Water pressure must be at least 30 psi (260 kPa). Avoid running water elsewhere while washer is filling. Water inlet hoses are kinked. Straighten hoses.
Warm or hot water is not hot enough.	<ul style="list-style-type: none"> Hot water heater is set too low or is a distance from washer. Measure hot water temperature at nearby faucet with candy or meat thermometer. Water temperature should be at least 130°F (70°C). Adjust water heater as necessary. Hot water is being used elsewhere in the house. Avoid using hot water elsewhere before or during washer use. There may not be enough hot water available for proper cleaning. If problem persists, your hot water system may be unable to support more than 1 use at a time.
Water in washer does not drain or drains slowly.	<ul style="list-style-type: none"> Drain hose is kinked or clogged. Clean and straighten the drain hose. House drain pipes are clogged. Unclog drain pipes. Contact plumber if necessary.
Water leaks.	<ul style="list-style-type: none"> Fill hose connection is loose at faucet or washer. Check and tighten hose connections. Install rubber sealing washers provided. Oversudsing. Use less detergent. Dispenser drawer is open. Close drawer when washer is operating.
Incorrect wash and rinse temperatures.	<ul style="list-style-type: none"> Hot and cold water hoses are connected to wrong supply faucets. Connect hot water hose to hot water faucet and cold water hose to cold water faucet.
Water is entering washer but tub does not fill.	<ul style="list-style-type: none"> Drain hose standpipe is incorrect height. Standpipe must be a minimum of 23.6" (60 cm) high to prevent siphoning. See INSTALLATION INSTRUCTIONS.

Major Appliance Warranty Information

Your appliance is covered by a one year limited warranty. For one year from your original date of purchase, Electrolux will pay all costs for repairing or replacing any parts of this appliance that prove to be defective in materials or workmanship when such appliance is installed, used and maintained in accordance with the provided instructions.

Exclusions **This warranty does not cover the following:**

1. Products with original serial numbers that have been removed, altered or cannot be readily determined.
2. Product that has been transferred from its original owner to another party or removed outside the USA or Canada.
3. Rust on the interior or exterior of the unit.
4. Products purchased "as-is" are not covered by this warranty.
5. Food loss due to any refrigerator or freezer failures.
6. Products used in a commercial setting.
7. Service calls which do not involve malfunction or defects in materials or workmanship, or for appliances not in ordinary household use or used other than in accordance with the provided instructions.
8. Service calls to correct the installation of your appliance or to instruct you how to use your appliance.
9. Expenses for making the appliance accessible for servicing, such as removal of trim, cupboards, shelves, etc., which are not a part of the appliance when it is shipped from the factory.
10. Service calls to repair or replace appliance light bulbs, air filters, water filters, other consumables, or knobs, handles, or other cosmetic parts.
11. Surcharges including, but not limited to, any after hour, weekend, or holiday service calls, tolls, ferry trip charges, or mileage expense for service calls to remote areas, including the state of Alaska.
12. Damages to the finish of appliance or home incurred during installation, including but not limited to floors, cabinets, walls, etc.
13. Damages caused by: services performed by unauthorized service companies; use of parts other than genuine Electrolux parts or parts obtained from persons other than authorized service companies; or external causes such as abuse, misuse, inadequate power supply, accidents, fires, or acts of God.

DISCLAIMER OF IMPLIED WARRANTIES; LIMITATION OF REMEDIES

CUSTOMER'S SOLE AND EXCLUSIVE REMEDY UNDER THIS LIMITED WARRANTY SHALL BE PRODUCT REPAIR OR REPLACEMENT AS PROVIDED HEREIN. CLAIMS BASED ON IMPLIED WARRANTIES, INCLUDING WARRANTIES OF MERCHANTABILITY OR FITNESS FOR A PARTICULAR PURPOSE, ARE LIMITED TO ONE YEAR OR THE SHORTEST PERIOD ALLOWED BY LAW, BUT NOT LESS THAN ONE YEAR. ELECTROLUX SHALL NOT BE LIABLE FOR CONSEQUENTIAL OR INCIDENTAL DAMAGES SUCH AS PROPERTY DAMAGE AND INCIDENTAL EXPENSES RESULTING FROM ANY BREACH OF THIS WRITTEN LIMITED WARRANTY OR ANY IMPLIED WARRANTY. SOME STATES AND PROVINCES DO NOT ALLOW THE EXCLUSION OR LIMITATION OF INCIDENTAL OR CONSEQUENTIAL DAMAGES, OR LIMITATIONS ON THE DURATION OF IMPLIED WARRANTIES, SO THESE LIMITATIONS OR EXCLUSIONS MAY NOT APPLY TO YOU. THIS WRITTEN WARRANTY GIVES YOU SPECIFIC LEGAL RIGHTS. YOU MAY ALSO HAVE OTHER RIGHTS THAT VARY FROM STATE TO STATE.

If You Need Service Keep your receipt, delivery slip, or some other appropriate payment record to establish the warranty period should service be required. If service is performed, it is in your best interest to obtain and keep all receipts. Service under this warranty must be obtained by contacting Electrolux at the addresses or phone numbers below.

This warranty only applies in the USA and Canada. In the USA, your appliance is warranted by Electrolux Major Appliances North America, a division of Electrolux Home Products, Inc. In Canada, your appliance is warranted by Electrolux Canada Corp. Electrolux authorizes no person to change or add to any obligations under this warranty. Obligations for service and parts under this warranty must be performed by Electrolux or an authorized service company. Product features or specifications as described or illustrated are subject to change without notice.

USA
1.800.944.9044
Electrolux Major Appliances
North America
P.O. Box 212378
Augusta, GA 30907



Canada
1.800.668.4606
Electrolux Canada Corp.
5855 Terry Fox Way
Mississauga, Ontario, Canada
L5V 3E4