



# Panasonic®

## Personal Computer

# OPERATING INSTRUCTIONS

## CF-37 Series

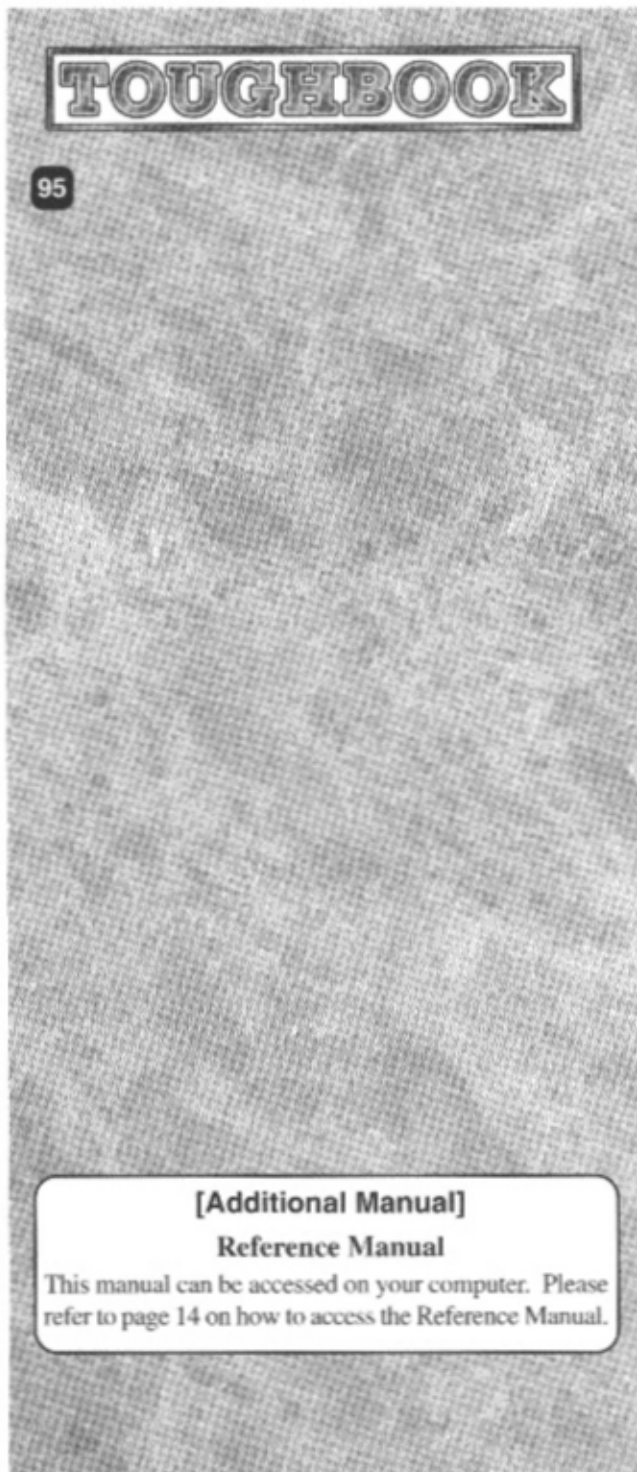

## Contents

### Getting Started

Read Me First .....	7
First-time Operation .....	9
Touch Pad (Basic Operation) .....	13
Reference Manual .....	14

#### Reference Manual

- Read Me First
- Key Combination
- LED Indicators
- Touch Pad (Advanced)
- Touchscreen
- Panasonic Hand Writing (Touchscreen)
- Display Rotation Tool

### Operation

Starting Up/Shutting Down .....	15
---------------------------------	----

#### Reference Manual

- Suspend/Hibernation Functions
- Security Measures
- Computing On The Road
- Battery Power
- Multimedia Pocket
- CD-ROM/DVD-ROM Drive
- SuperDisk™ Drive
- PC Cards
- RAM Module
- Printer
- External Display
- USB Devices
- Infrared Data Communications
- Modem
- Hard Disk Drive
- Setup Utility
- Smart Boot

### Troubleshooting

List of Error Codes .....	17
Dealing With Problems (Summary) .....	19
Reinstalling Software .....	21

#### Reference Manual

- Technical Information
- DMI Viewer
- List of Error Codes
- Dealing With Problems (Advanced)

### Appendix

LIMITED USE LICENSE AGREEMENT .....	22
Names and Functions of Parts .....	24
Specifications .....	25
LIMITED WARRANTY .....	26

Getting Started

Operation

Troubleshooting

Appendix

## Customer's Record



Model No. _____	Dealer's Name _____
Serial No. _____	_____
or	
Code No. _____	Dealer's Address _____
Date of Purchase _____	_____

For the Model No., insert the 11 digit number (for example, CF-37VB62AAM) located on the bottom of the computer.

### Introduction

Thank you for purchasing the Panasonic computer. Please read the operating instructions thoroughly for proper operation of your new computer.

### Illustrations in this Manual

- NOTE:** **NOTE** provides a useful fact or helpful information.
- CAUTION:** **CAUTION** indicates a condition that may result in minor or moderate injury.
- WARNING:** **WARNING** indicates a hazard that may result in moderate or serious injury.
- [Start]-[Shut Down]: This illustration means to click [Start], then to click [Shut Down].  
(For some applications, you may need to double-click.)
- Enter** : This illustration means to press the [Enter] key.
- Fn** + **F5** : This illustration means to press and hold the [Fn] key, then press the [F5] key.
-  : Where to go for referred information.
-  **Reference Manual** : This illustration means to refer to the Reference Manual, which is available on your computer. Please refer to page 14 on how to access this manual.

### Copyright

This manual is copyrighted by Matsushita Electric Industrial Co., Ltd. with all rights reserved. No part of this manual may be reproduced in any form without the prior written permission of Matsushita Electric Industrial Co., Ltd. No patent liability is assumed with respect to the use of the information contained herein.

©Matsushita Electric Industrial Co., Ltd. 1999. All Rights Reserved.

### Disclaimer

Computer specifications and manuals are subject to change without notice. Matsushita Electric Industrial Co., Ltd. assumes no liability for damage incurred directly or indirectly from errors, omissions or discrepancies between the computer and the manuals.

### Trademarks

PS/2™ is a trademark of International Business Machines Corporation.

Microsoft®, MS-DOS® and Windows® are registered trademarks of Microsoft Corporation of the United States and/or other countries.

Intel® is a registered trademarks of Intel Corporation.

Celeron™ is a trademark of Intel Corporation.

Imation, the Imation Logo, the circle-pyramid logo, SuperDisk and SuperDisk logo are trademarks of Imation Corp.

Acrobat® is a registered trademark of Adobe Systems Incorporated.

Panasonic® is a registered trademark of Matsushita Electric Industrial Co., Ltd.

## For U.S.A.

### Federal Communications Commission Radio Frequency Interference Statement

Note: This equipment has been tested and found to comply with the limits for a Class B digital device, pursuant to Part 15 of the FCC Rules. These limits are designed to provide reasonable protection against harmful interference in a residential installation. This equipment generates, uses and can radiate radio frequency energy and, if not installed and used in accordance with the instructions may cause harmful interference to radio communications. However, there is no guarantee that interference will not occur in a particular installation. If this equipment does cause harmful interference to radio or television reception, which can be determined by turning the equipment off and on, the user is encouraged to try to correct the interference by one or more of the following measures:

- Reorient or relocate the receiving antenna.
- Increase the separation between the equipment and receiver.
- Connect the equipment into an outlet on a circuit different from that to which the receiver is connected.
- Consult the Panasonic Service Center or an experienced radio/TV technician for help.

### Warning

To assure continued compliance, use only shielded interface cables when connecting to a computer or peripheral. Also, any changes or modifications not expressly approved by the party responsible for compliance could void the user's authority to operate this equipment.

This device complies with Part 15 of the FCC Rules. Operation is subject to the following two conditions:

- (1) This device may not cause harmful interference, and
- (2) This device must accept any interference received, including interference that may cause undesired operation.

Responsible Party: Matsushita Electric Corporation of America  
One Panasonic Way  
Secaucus, NJ 07094  
Tel No: 1-800-LAPTOP-5 (1-800-527-8675)

### FCC Regulation Notice for modem This equipment contains a FCC approved modem.

Manufacturer of modem: 3Com Corporation  
Model No. 3CN3BM556

 **Tested To Comply  
With FCC Standards  
FOR HOME OR OFFICE USE**

1. This equipment complies with Part 68 of the FCC rules. On the computer is a label that contains, among other information, the FCC registration number and ringer equivalence number (REN) for this equipment. If required, this information must be provided to the telephone company.
2. An FCC compliant telephone cord and modular plug is provided with this equipment. This equipment is designed to be connected to the telephone network or premises wiring using a compatible modular jack which is Part 68 compliant. See Installation Instructions for details.
3. The REN is used to determine the quantity of devices which may be connected to the telephone line. Excessive RENs on the telephone line may result in the devices not ringing in response to an incoming call. In most, but not all area, the sum of RENs should not exceed five (5.0). To be certain of the number of devices that may be connected to a line, as determined by the total RENs, contact the local telephone company.
4. If your telephone equipment cause harm to the telephone network, the telephone company will notify you in advance that temporary discontinuance of service may be required. But if advance notice isn't practical, the telephone company will notify the customer as soon as possible. Also, you will be advised of your right to file a complaint with the FCC if you believe it is necessary.
5. The telephone company may take changes in its facilities, equipment, operations or procedures that could affect the operation of the equipment. If this happens the telephone company will provide advance notice in order for you to make necessary modifications to maintain uninterrupted service.
6. If trouble is experienced with this equipment, for repair or warranty information, please contact Matsushita Electric Corporation of America, toll free at 1-800-LAPTOP5 (1-800-527-8675). If the equipment is causing harm to the telephone network, the telephone company may request that you disconnect the equipment until the problem is resolved.
7. There are no user serviceable parts contained in this equipment.
8. This equipment may not be used on coin service provided by the telephone company. Connection to party lines is subject to state tariffs.
9. The Telephone Consumer Protection Act of 1991 makes it unlawful for any person to use a computer or other electronic device to send any message via a telephone fax machine unless such message clearly contains in a margin at the top or bottom of each transmitted page or on the first page of the transmission, the date and time it is sent and an identification of the business or other entry, or other individual sending the message and the telephone number of the sending machine or such business, other entity, or individual. In order to program this information into your fax software, you should refer to the manual of the Fax software being used.

"Caution : To reduce the risk of fire, use only No.26 AWG or larger telecommunication line cord."

"ATTENTION : Pour réduire le risque d'incendie, utiliser uniquement des conducteurs de télécommunications 26 AWG ou de section supérieure."

## For Canada

### Industry Canada (IC) Notice for modem

This equipment contains an Industry Canada approved modem unit. The Industry Canada label is affixed on the modem unit.

### EQUIPMENT ATTACHEMENT LIMITATIONS

“NOTICE: The Industry Canada label identifies certified equipment. This certification means that the equipment meets telecommunications network protective, operational and safety requirements as prescribed in the appropriate Terminal Equipment Technical Requirements document(s). The Department does not guarantee the equipment will operate to the user’s satisfaction.

Before installing this equipment, users should ensure that it is permissible to be connected to the facilities of the local telecommunications company. The equipment must also be installed using an acceptable method of connection. The customer should be aware that compliance with the above conditions may not prevent degradation of service in some situations.

Repairs to certified equipment should be coordinated by a representative designated by the supplier. Any repairs or alterations made by the user to this equipment, or equipment malfunctions, may give the telecommunications company cause to request the user to disconnect the equipment.

Users should ensure for their own protection that the electrical ground connections of the power utility, telephone lines and internal metallic water pipe system, if present, are connected together. This precaution may be particularly important in rural areas. Caution: Users should not attempt to make such connections themselves, but should contact the appropriate electric inspection authority, or electrician, as appropriate.”

“NOTICE: The Ringer Equivalence Number (REN) assigned to each terminal device provides an indication of the maximum number of terminals allowed to be connected to a telephone interface. The termination on an interface may consist of any combination of devices subject only to the requirement that the sum of the Ringer Equivalence Numbers of all the devices does not exceed 5.”

REN: See bottom of the computer

### RESTRICTIONS CONCERNANT LE RACCORDEMENT DE MATÉRIEL

“AVIS: L’étiquette d’Industrie Canada identifie le matériel homologué. Cette étiquette certifie que le matériel est conforme aux normes de protection, d’exploitation et de sécurité des réseaux de télécommunications, comme le prescrivent les documents concernant les exigences techniques relatives au matériel terminal. Le Ministère n’assure toutefois pas que le matériel fonctionnera à la satisfaction de l’utilisateur.

Avant d’installer ce matériel, l’utilisateur doit s’assurer qu’il est permis de le raccorder aux installations de l’entreprise locale de télécommunication. Le matériel doit également être installé en suivant une méthode acceptée de raccordement. L’abonné ne doit pas oublier qu’il est possible que la conformité aux conditions énoncées ci-dessus n’empêche pas la dégradation du service dans certaines situations.

Les réparations de matériel homologué doivent être coordonnées par un représentant désigné par le fournisseur. L’entreprise de télécommunications peut demander à l’utilisateur de débrancher un appareil à la suite de réparations ou de modifications effectuées par l’utilisateur ou à cause de mauvais fonctionnement.

Pour sa propre protection, l’utilisateur doit s’assurer que tous les fils de mise à la terre de la source d’énergie électrique, des lignes téléphoniques et des canalisations d’eau métalliques, s’il y en a, sont raccordés ensemble. Cette précaution est particulièrement importante dans les régions rurales. Avertissement: L’utilisateur ne doit pas tenter de faire ces raccordements lui-même; il doit avoir recours à un service d’inspection des installations électriques, ou à un électricien, selon le cas.”“AVIS: L’indice d’équivalence de la sonnerie (IES) assigné à chaque dispositif terminal indique le nombre maximal de terminaux qui peuvent être raccordés à une interface. La terminaison d’une interface téléphonique peut consister en une combinaison de quelques dispositifs, à la seule condition que la somme d’indices d’équivalence de la sonnerie de tous les dispositifs n’excède pas 5.”

REN: Voir sous le fond de l’ordinateur

## Lithium Battery

### Lithium Battery!

This computer contains a lithium battery to enable the date, time, and other data to be stored. The battery should only be exchanged by authorized service personnel.

Warning! A risk of explosion from incorrect installation or misapplication may possibly occur.

### Warnung bezüglich der Lithiumbatterie (Sicherungsbatterie)

Lithiumbatterie!

Dieser Computer enthält eine Lithiumbatterie zur Sicherung von Datum und Uhrzeit der eingebauten Uhr sowie anderer Systemdaten im Speicher bei einer Unterbrechung der Hauptstromversorgung. Diese Sicherungsbatterie darf nur von Kundendienstpersonal ausgewechselt werden.

Warnung! Bei falschem Gebrauch besteht Explosionsgefahr!

Entsorgung gebrauchter Batterien nach Angaben des Herstellers.

### Avertissement concernant la pile au lithium (pile de sauvegarde)

Pile au lithium!

Le micro-ordinateur renferme une pile au lithium qui permet de sauvegarder certaines données comme la date et l'heure notamment. Elle ne devra être remplacée que par un technicien qualifié.

Avertissement! Risque d'explosion en cas de non respect de cette mise en garde!

## CD-ROM Drive Caution

### CAUTION!

THIS PRODUCT UTILIZES A LASER.  
USE OF CONTROLS, ADJUSTMENTS OR PERFORMANCE OF PROCEDURES OTHER THAN THOSE SPECIFIED HEREIN MAY RESULT IN HAZARDOUS RADIATION EXPOSURE.  
DO NOT OPEN COVERS AND DO NOT REPAIR YOURSELF.  
REFER SERVICING TO QUALIFIED PERSONNEL

### WARNUNG!

DIESES PRODUKT ERZEUGT LASERSTRAHLUNG.  
DURCHFÜHRUNG ANDERER VORGÄNGE ALS DER HIER ANGEGBENEN KANN ZU GEFÄHRLICHER STRAHLUNG FÜHREN.  
REPARATUREN DÜRFEN NUR VON QUALIFIZIERTEM FACHPERSONAL DURCHGEFÜHRT WERDEN.

### AVERTISSEMENT!

CET APPAREIL UTILISE UN LASER.  
L'UTILISATION DE COMMANDES OU DE RÉGLAGES OU L'EXÉCUTION DE PROCÉDURES AUTRES QUE CELLES SPÉCIFIÉES ICI PEUVENT PROVOQUER UNE EXPOSITION À DES RADIATIONS DANGEREUSES.  
NE PAS OUVRIR LES COUVERCLES NI ESSAYER DE RÉPARER SOI-MÊME.  
CONFIER TOUT TRAVAIL D'ENTRETIEN À UN PERSONNEL QUALIFIÉ.

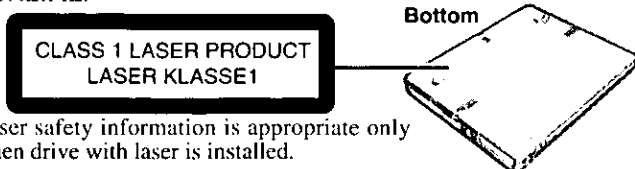

Laser safety information is appropriate only when drive with laser is installed.

Les mesures de sécurité relatives au laser ne s'appliquent que lors de l'installation d'une unité avec laser.

## Precautions

### Usage



#### Avoid Extreme Heat and Cold

Do not store or use the computer in locations exposed to heat, direct sunlight, or extreme cold. Avoid moving the computer between locations with large temperature differences.

Operation: 5 °C to 35 °C (41 °F to 95 °F)

Storage: -20 °C to 60 °C (-4 °F to 140 °F)

#### Avoid Direct Sunlight on the LCD Panel

The LCD panel should not be exposed to direct sunlight or ultraviolet light.



#### Avoid Humidity, Liquids and Dust

Do not store or use the computer in locations exposed to high humidity, liquids (including rain) or dust.



#### Prevent Shock

Avoid subjecting the computer to severe vibrations or impact. Do not place the computer inside a car trunk.

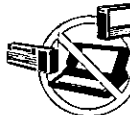

#### Avoid Radio Frequency Interference

Do not place the computer near a television or radio receiver.

#### Avoiding low-temperature burns

Avoid more than casual contact with any heat producing area of the notebook computer, power adapter, and any option or accessory you use with it. Even low heat, if warmer than body temperature, can cause a burn, if the skin is exposed to the heat source for a long enough period of time.

### Handling



#### Avoid Magnetic Fields

Keep the computer away from magnets.



#### Avoid Stacking

Do not place heavy objects on top of the computer.



#### Keep Small Objects Away

Do not insert paper clips or other small objects into the computer.



#### Do Not Disassemble the Computer

Do not attempt to disassemble your computer.



#### Avoid Excessive Force on the Display

Do not apply excessive downward force on the display when it is completely opened, especially when plugs and/or cables are connected to the rear of the computer.

### Peripherals

Incorrectly using peripheral devices may lead to a decrease in performance, an increase in temperature and/or damage your computer. For more information on peripheral devices, please refer to the Reference Manual.

### Cables

Use of an interface cable longer than 3 m (9.84 feet) is not recommended.

## Precautions

### ● Peripherals

Incorrectly using peripheral devices may lead to a decrease in performance, an increase in temperature and/or damage to your computer. For more information on peripheral devices, please refer to the Reference Manual.

- Care should be exercised with regard to the following in order to avoid the possibility of liquid leakage, overheating, or bursting.



#### **Avoid Heat**

Do not throw the battery pack into a fire or expose it to excessive heat.



#### **Keep Articles Away**

Do not place the battery pack together with articles such as necklaces or hairpins when carrying or storing.



#### **Do Not Disassemble**

Do not insert sharp objects into the battery pack, expose it to bumps or shocks, deform, disassemble, or modify it.



#### **Do Not Short**

Do not short the positive (+) and negative (-) contacts.



#### **Avoid Extreme Heat, Cold and Direct Sunlight**

Do not charge, use or leave the battery pack for extended periods where it will be exposed to direct sunlight, in a hot place (in an automobile on a sunny day, for example), or in a cold place.



#### **Do Not Use With Any Other Computer**

The battery pack is rechargeable and was intended for the specified computer or charger. Do not use it with a computer other than the one for which it was designed.



#### **Do Not Put into a Microwave**

Do not put the battery pack into a microwave oven or a pressurized chamber.





#### **Discontinue Use**

Should the battery emit an abnormal odor, become hot to the touch, become discolored, change shape, or become in any way different from normal, remove it from the computer or charger and discontinue use.

- Do not touch the terminals on the battery pack. The battery pack may no longer function properly if the contacts are dirty or damaged.
- Do not expose the battery pack to water, or allow it to become wet.

- If the battery pack will not be used for a long period of time (a month or more), charge or discharge (use) the battery pack until the remaining battery level becomes 30% to 40% and store it in a cool, dry place.
- This computer prevents overcharging of the battery by recharging only when the remaining power is less than approx. 95% of capacity.
- The battery pack is not charged when the computer is first purchased. Be sure to charge it before using it for the first time. When the AC adapter is connected to the computer, charging begins automatically.
- Should the battery leak and the fluid get into your eyes, do not rub your eyes. Immediately flush your eyes with clear water and see a doctor for medical treatment as soon as possible.

### NOTE

- The battery pack may become warm during recharging or normal use. This is completely normal.
- Recharging will not commence outside of the allowable temperature range (0 °C to 45 °C {32°F to 113 °F})  Reference Manual "Battery Power". Once the allowable range requirement is satisfied, charging begins automatically. Note that the recharging time varies based on the usage conditions. (Recharging takes longer than usual when the temperature is 10 °C {50 °F} or less.)
- If the temperature is low, the operating time is shortened. Only use the computer within the allowable temperature range.
- Although the battery has remaining capacity, the battery indicator may light up red or emit a beep. This indicates a significant rise in the temperature (60 °C {140 °F} or more) of the battery pack  Reference Manual "Battery Power". This is typically caused by the fact that the battery pack has been delivering a high level of power because the computer has been used with the display at the brightest setting and with the power-saving function off. To protect the battery pack from increases in temperature, the brightness of the display automatically decreases, allowing the temperature of the battery to drop. In this condition, if the computer is left as is, it will automatically go off after about three minutes have elapsed. Within that period, therefore, be sure to connect the AC adapter or shut the computer OFF after saving any open data (if necessary).
- The battery pack is a consumable item. If the amount of time the computer can be run off a particular battery pack becomes dramatically shorter and repeated rechargings do not restore its performance, the battery pack should be replaced with a new one.
- When a spare battery pack is to be carried in a pocket or bag, it is recommended that it be placed in a plastic bag so that its contacts are protected.
- Always power off the computer when it is not in use. Leaving the computer on when the AC adapter is not connected will exhaust the remaining battery capacity.

# Read Me First

## Saving Data on the Hard Disk

- **Do not expose your computer to shock.**  
Please use care when handling your computer, shock may damage your hard disk or make your software applications and data unusable.
- **Do not power off your computer while software applications are running or HDD indicator (HDD) is on.**  
Properly shut Windows\* down to avoid problems ([Start] - [Shut Down] ).
- **Save all valuable data to disks.**  
Backing up data to disks will limit damage should trouble occur to your computer or should you inadvertently change or erase data.
- **Use the security function for all important data.** (  Reference Manual "Security Measures")

\* This computer uses Microsoft® Windows® 95 Operating System.

## Saving Data on Disks

### NOTE

In this manual, the followings are described as disks.  
When using disks, an optional SuperDisk Drive Pack (CF-VFS371) is needed.  
SuperDisk (120 MB)  
Floppy disk (720 KB, 1.44 MB)

- **Do not power off your computer or press the SuperDisk drive eject button while the MP indicator (MP) is on.**  
Doing so may damage the data on the disk and render the disk useless.
- **Use care when handling disks.**  
To protect the data on your disks or to prevent a disk from becoming stuck in your computer, avoid the following:
  - Sliding the shutter on the disk manually.
  - Exposing the disk to a magnetic field.
  - Storing the disk in locations prone to high temperatures, low pitched noise, dampness, or dust.
  - Applying more than one label on the disk.
- **Confirm the contents of a disk before formatting it.**  
Confirm that no important data is on the disk, because all data on the disk will be erased.
- **Use the write-protect tab.**  
This is a must for preserving important data. This prevents your data from being erased or overwritten.

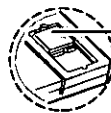

Write Enable

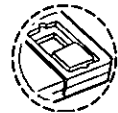

Write Disable

## Computer Viruses

- **Users are advised to purchase the latest versions of virus protection software and use them regularly.**  
We recommend you run the software:
  - When booting your computer.
  - After receiving data.We recommend that you check data received on disks or from external sources, such as data downloaded from the Internet, e-mail, etc. (For compressed files, please uncompress them before running a check).

## LCD Panel

High-precision and advanced technologies are necessary in the production of color liquid crystal displays (color LCDs). Therefore, if 99.998% or more of the picture elements are functioning properly, no defect is considered to exist.

# Read Me First

## Usage Environment

### ● Environment

- Place the computer on a flat stable surface.
- In use: Temperature: 5 °C to 35 °C {41 °F to 95 °F}  
Humidity: 30% to 80% RH (No condensation)
- Not in use: Temperature: -20 °C to 60 °C {-4 °F to 140 °F}  
Humidity: 30% to 90% RH (No condensation)

### ● Places not to use your computer

- Such areas may result in damage to the computer.

#### Areas with electronic equipment

These areas may interfere with your display or cause your computer to produce strange sounds.

#### Areas with extremely high/low temperatures



- Do not leave things near the computer that are sensitive to heat. During operation, the computer may become warm.

## Handling

- This computer has been designed so as to minimize shock to the LCD and hard disk drive, the leakage of liquid (e.g., water) from the keyboard, etc., but no warranty is provided against such trouble. Therefore, as a precision instrument, please be extremely careful in the handling.
  - Do not drop or hit your computer against solid objects.  
Do not stand the computer on its side or allow it to tip over. When the computer receives extremely strong shock after falling, the hard disk or floppy disk drive, etc., may become inoperable.
  - Do not carry your computer when it is ON.
  - Remove all cables before transporting your computer.
  - We recommend preparing a fully charged battery (and optional charger, if possible).  
When transporting spare batteries inside a package, briefcase, etc., it is recommended that the batteries be stored in a plastic bag.
  - Do not place the computer upright. When the computer receives extremely strong shock after falling, the hard disk or floppy disk drive, etc., may become inoperable.
  - Do not carry the computer while the display is open, or carry it by gripping the display.
  - Do not put anything (e.g., a piece of paper) between the display and keyboard.
  - Always carry your computer with you. Never check it in with luggage. For use of the computer inside an aircraft, we recommend asking the airlines regarding their policy on this issue.
- <When using the SuperDisk drive>
- It is a good idea to make backup copies on disks and carry them with you.
  - Do not leave a disk in the drive while transporting your computer.

## Maintenance

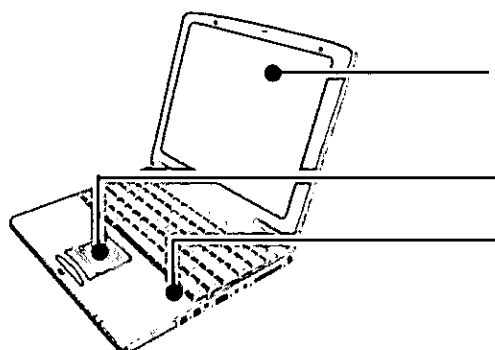

#### Display

Use a soft dry cloth like gauze to lightly wipe the display.

#### Touch Pad

☞ page 13

#### Areas excluding the display

Wipe these areas with a soft cloth, after applying water or detergent diluted with water to the soft cloth and firmly wringing out excess water.











# First-time Operation

Please read the steps below to help you learn what parts are included, and to gain an understanding of some basic computer-related operations.

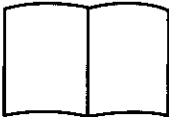
## 1 Confirm the inclusion of all parts

Make sure the parts shown in the figure have been supplied. If any of these items are missing or is not working properly, please contact Panasonic Technical Support.

<b>AC Adapter</b> ..... 1  CF-AA1639	<b>AC Cord</b> ..... 1 
<b>Battery Pack</b> ..... 1  CF-VZSU14	<b>Modem Telephone Cable</b> ..... 1 
<b>Operating Instructions</b> ..... 1 	<b>Windows 95 System Pack</b> .... 1  Windows® 95 Book  Registration Card  Product Recovery CD-ROM

## 2 Read the LIMITED USE LICENSE AGREEMENT (page 22)

Before removing the seal covering the power switch, please read the LIMITED USE LICENSE AGREEMENT.

## 3 Connect the battery pack

① Turn your computer over.

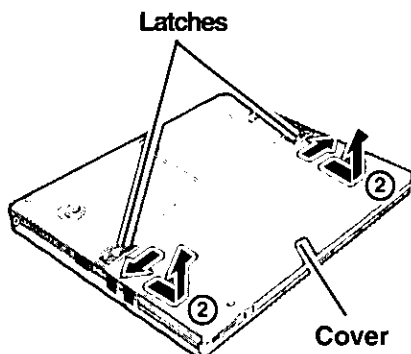

② While sliding and holding the latches in the outward positions, slide the cover to open it.

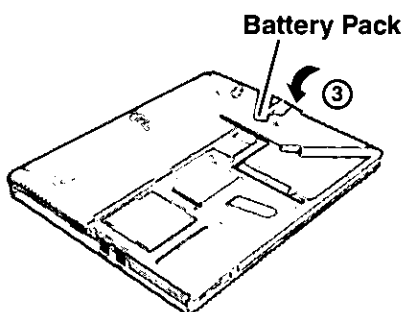

③ Use the blue tab to lower the battery pack into place.

### CAUTION

- Be sure the battery pack is properly connected to the connector.
- Do not touch the battery connector on the computer. The computer may not operate properly.

# First-time Operation

- ④ Position the cover so that the edge of the cover is aligned with the lines of the computer.  
Then, while lightly pressing down on the center of the cover (with suppressing the back of the computer by one hand), gently slide the cover until it snaps into place.

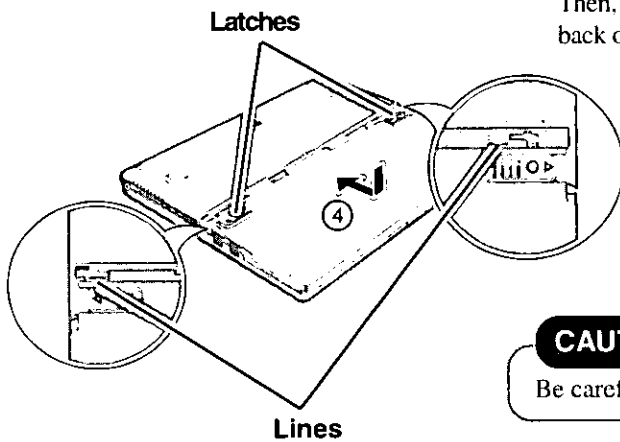

## CAUTION

Be careful not to get your fingers caught in the cover.

## 4 Connect your computer to a power outlet

### CAUTION

Be sure the AC adapter is connected until completing Step 6 on page 11.

#### Handling the AC adapter

- Do not twist or pull the AC power cord forcefully. Doing so may damage the connections.
- Use only the specified AC adapter with your computer. Using an AC adapter other than the one supplied might damage the battery and/or the computer.
- When the DC plug is not connected to the computer, disconnect the AC cord from your AC wall outlet.
- Problems such as sudden voltage drops may arise during periods of thunder and lightning. Since this could adversely affect your computer, an uninterruptible power source (UPS) is highly recommended unless the battery pack is installed.

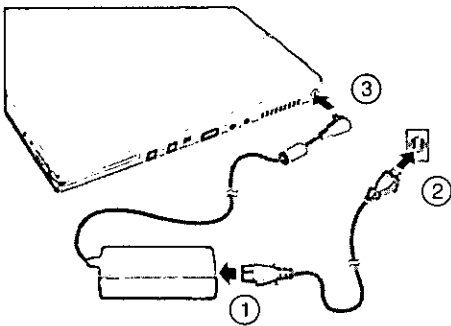

## 5 Turn your computer on

Slide the power switch and hold it for approximately one second until the power indicator (⏻) turns on before releasing it.

### CAUTION

- After confirming that the power indicator has turned on, do not touch the power switch until Windows setup has started.
- Once the computer is powered off, you must wait at least ten seconds before powering it on again.

### NOTE

The power saving function is factory set, so if there is no input from a key, the touch pad, or the external mouse for two minutes, the LCD is powered off (ECO mode Reference Manual "Computing on the Road" ).\*

In the ECO mode the LCD will resume operation when the touch pad is used, or when a key or the touchscreen is pressed.

The computer may enter the ECO mode while Windows is setting up or even when an application software is being installed. In this case, because it is conceivable that a selection dialog box will be shown, for resuming from the ECO mode, do not press **Enter** which may trigger a selection. Instead, press a key unrelated to the direct triggering of a selection, like **Ctrl** key.

\* This excludes a pointing device connected to the USB port, e.g., a USB mouse.

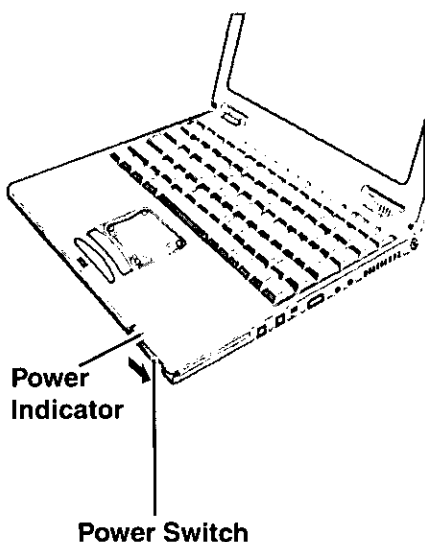

## 6 Setup Windows 95

- ① Select settings for your region, then press [Next].

### NOTE

Moving the cursor (⏶) or clicking buttons can be performed with the touch pad, a key or the touchscreen. (☞ page 13, Reference Manual "Touchscreen")

- ② Select your keyboard layout, then press [Next].  
(for U.S.A.: United States 101)
- ③ Enter your name and your company's name, then press [Next].  
(It is possible to omit the company name item.)  
The License Agreement will be displayed.
- ④ After reading the agreement, select [I accept the agreement] or [I don't accept the agreement], then press [Next].

### NOTE

If [I accept the agreement] is selected, the [Certificate of Authenticity] will appear.  
If [I don't accept the agreement] is selected, the Windows setup will be aborted.

- ⑤ Input the Product Number written on the "Certificate of Authenticity" located in the Windows® 95 book that provided with this computer, then press [Next].
- ⑥ Press [Finish].
- ⑦ Input the correct date, time and time zone and press [Close].  
You can also complete these settings at a later time.
- ⑧ Press [Next] to complete the printer setup or [Cancel] to skip.

### NOTE

Follow the on-screen instructions. You can complete these settings at a later time.

- ⑨ When the following screen is displayed, add the check mark depending on your needs.

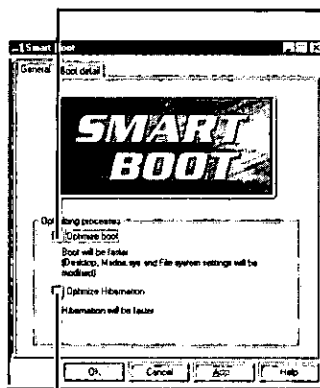

If this box is checked, it is possible to shorten the start-up time from the computer OFF state and the following occurs.

- The Windows Logo display (i.e., the cloud display) is not shown at start-up.
- The channel bar of Internet Explorer 4.0 is not shown.
- No background paper is displayed.
- "Welcome" of Internet Explorer 4.0 is not shown.
- To display the start-up menu by pressing **F8** at start-up, it is necessary to press **F8** slightly faster than normal.

If this box is checked, the time to enter the hibernation mode and the time to resume from the hibernation mode are shortened.

### NOTE

You can complete these settings at a later time. (☞ Reference Manual "Smart Boot")

Then, when the alignment of the touchscreen is needed, perform [Calibrate] in [Start] - [Programs] - [Updd]. (☞ Reference Manual "Touchscreen")

**This concludes the first-time use operation guidelines.**

# First-time Operation

## Create backup disks

For reinstallation (☞ page 21), create backup disks. To create backup disks, the optional SuperDisk Drive Pack (CF-VFS371) and 2HD floppy disks are needed.

- ① Turn the computer off, then remove the CD-ROM drive (☞ Reference Manual "Multimedia Pocket").
- ② Insert the SuperDisk Drive Pack in the multimedia pocket and turn the computer on.
- ③ Set a floppy disk and make sure it is not in the write-protected state, then select [Start] - [Programs] - [Panasonic] - [Create BACKUP DISK] and follow the on-screen instructions. Place a label identifying the contents on each disk.

### ● Name of created backup disk

FIRSTAID FD

(When the display for creating the UPDATE DISK is shown, create the disk by following the on-screen instructions.)

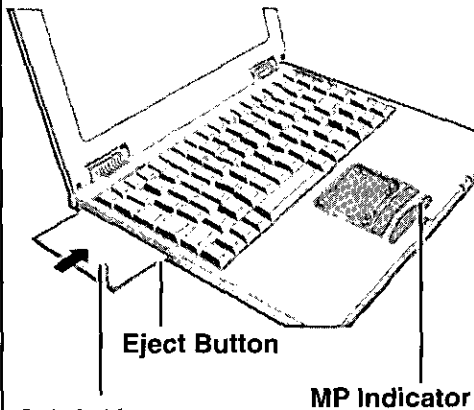

Label-side up  
Insert the shutter-side  
headfirst.

MP Indicator

### CAUTION

- Please store the floppy disks in a safe place. They will enable you to return your computer to the condition at the time of purchase should any problems occur.  
When creating floppy disks, do not run any other application program.
- When creating floppy disks and the message [Insufficient files to copy] is displayed, click [OK] and then contact Panasonic Technical Support.
- While the MP indicator (MP) is on, do not remove the floppy disk, power down your computer or use the suspend or hibernation function (☞ Reference Manual "Suspend/Hibernation Functions").

### NOTE

When using the files in the following folders available on the retail version of the Windows 95 CD-ROM, it is necessary to run a separate file decompression program.

\admin  
\datalink  
\drivers  
\help  
\other

To uncompress the file, it is necessary to have about 75 MB of free disk space on the hard disk.

To be able to use the CD-ROM drive, or DVD-ROM drive in the MS-DOS mode, perform the operation below after modifying config.sys and autoexec.bat

(☞ Reference Manual "CD-ROM/DVD-ROM Drive").

File decompression method:

- ① Turn your computer on.
- ② When [Starting Windows 95] is displayed, press **F8**.
- ③ Select [Command prompt only].
- ④ Insert the Product Recovery CD-ROM.

At the prompt, input the following:

L:\en\addfile **Enter**

Follow the message on the screen.

After this program is executed, the contents of the above folders will be decompressed to the c:\util\win95add folder.

# Touch Pad (Basic Operation)

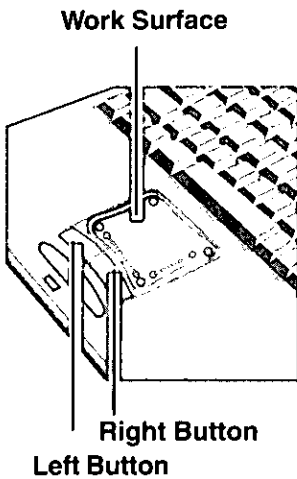



Use the touch pad to move the cursor on the display and perform normal computer operations. For instructions on how to operate, refer to <sup>Reference Manual</sup> "Touch Pad (Advanced)".

## NOTE

The touch pad has been designed to work only when a finger is used. Therefore, do not use any implement on the touch pad.

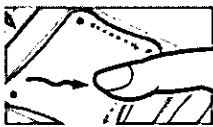
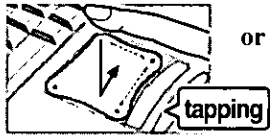
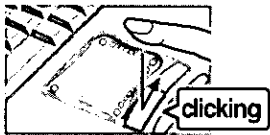
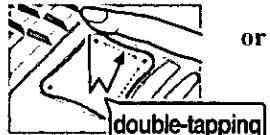
## Basic-Operation

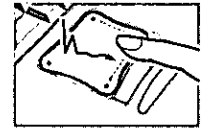
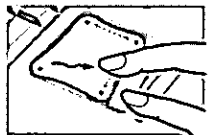
Function	Touch Pad Operation
Moving the Cursor	 Move the tip of your finger lightly over the surface.
Tapping/Clicking	 tapping or  clicking
Double-Tapping/ Double-Clicking	 double-tapping or  double-clicking
Dragging	 or  Two quick taps, but on the second tap leaving your finger down (applying pressure) and moving it on the work surface. While holding down the button, moving your finger on the work surface.

## Handling the Touch-Pad

- Do not place any object on the work surface or press down forcefully with sharp-pointed objects (i.e. nails), hard objects that can leave marks (i.e. pencils and ball point pen).
- Do not allow things that could dirty the touch pad, such as oil. The cursor may not work properly in such cases.
- When the touch pad becomes dirty:  
Wipe to remove dirty areas by using a dry soft cloth such as gauze or a soft cloth first applied with detergent diluted with water and then thoroughly wrung.  
Do not use benzene or thinner, or disinfectant-type alcohol.

# Reference Manual

The Reference Manual can be accessed on your computer. When a printer is connected, the Reference Manual can also be printed.

This manual explains functions for you to make greater use of the computer, such as how to add peripheral devices, how the Setup Utility works and other useful information.

## Run the Reference Manual

**1** Turn your computer on

**2** Select [Reference Manual] in [Start] - [Programs] - [Panasonic] - [On-Line Manuals]

When the Reference Manual is started up for the first time, the License Agreement will be displayed. After reading the agreement, select [Accept] to access the Reference Manual.

### NOTE

When the Reference Manual is run for the first time, an error message may appear if the Reference Manual is run using a method that differs from the above explanation. If an error message appears, press [OK].

**Zoom-in**  
Go forward or backward a page, or to the beginning or end of a document.

**Hand tool**  
To move around the current page.

**Cancel or correct an operation**

**Change the display size**

**Perform a "Find" operation**

**Exit**

**Table of Content (Items)**  
By clicking an item, the corresponding page will be displayed at 100%.

**Display of the manual**

**Movable splitter bar**  
This bar can be dragged, for example, to the right to enlarge the display of the Table of Contents.

**Page indicator**  
A desired page can be displayed by inputting the page number after clicking here.

**Change the display size**  
You can choose to magnify/de-magnify the display.

(The display may be changed without notification.)

Read Me First	2
Key Combinations	4
LED Indicators	5
Touch Pad (Advanced)	6
Touchscreen	11
Panasonic Hand Writing (Touchscreen)	13
Display Rotation Tool	14
Suspend/Hibernation Functions	15
Security Measures	18
Computing On The Road	22
Battery Power	23
Multimedia Pocket	32
CD-ROM/DVD-ROM Drive	33
SuperDisk™ Drive	36
PC Cards	38
RAM Module	39
Printer	40
External Display	41
USB Devices	42
Infrared Data Communications	44

### NOTE

- Illustrations may be difficult to view depending on the magnification. If this is the case, we recommend that the display be magnified.
- When the taskbar is hidden at the bottom portion of Acrobat® Reader, set the maximum display window size.
- If a printer is connected, we recommend printing pages. The illustrations and display samples may not print with a high quality.

# Starting Up/Shutting Down

## Starting Up

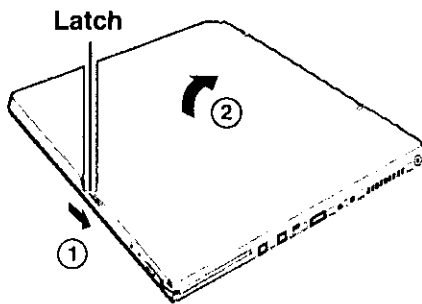

### 1 Open the display

- 1 Slide the latch as shown.
- 2 Lift open the display.

### 2 Turn your computer on

Slide the power switch as shown and hold it for approximately one second until the power indicator turns on before releasing it.

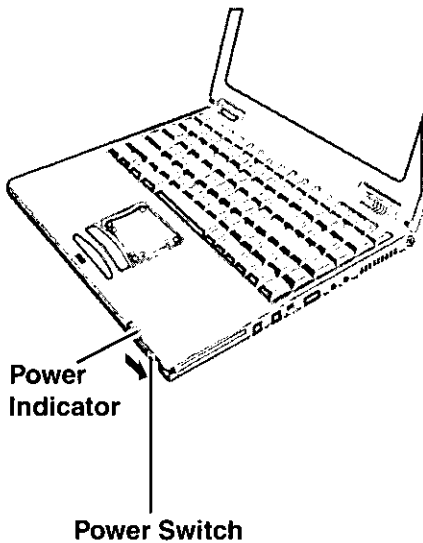

#### CAUTION

- The computer will not power on when the display is closed (except when connecting an external display or when [Panel Switch] has been set to [LCD Off] in the Setup Utility Reference Manual "Setup Utility").
  - After confirming that the power indicator has turned on, avoid the following until Windows has completed loading.
    - Touching the power switch.
    - Performing any keyboard, touch pad, touchscreen (or external mouse) operations.
    - Closing the display.If the display is closed while Windows is starting up, it is possible that color, etc., will not be displayed properly. Run the [MS-DOS Prompt] ([Start] - [Programs] - [MS-DOS Prompt]), and use full screen display mode by pressing **Alt** + **Enter**. After returning from the full screen mode **Alt** + **Enter** again, the display will be shown correctly.
  - Once the computer is powered off, you must wait at least ten seconds before powering it on again.
  - When the CPU temperature rises, the computer may not power on to prevent the CPU from overheating. Should this happen, allow the computer to cool down then switch the power on again.
- If the computer still does not power on, please contact Panasonic Technical Support.

### ● Select a device to start up the Operating System

You can select the device for starting up the Operating System when starting up the computer. It is not necessary to change the settings of the [Boot] menu in the Setup Utility.

- 1 Turn the computer on and press **Esc** when [Press <Esc> to enter Boot First Menu] is displayed.
- 2 Select the device from the menu, press **Enter**.

#### NOTE

- When the Operating System is unable to start up from the selected device, it will start up from the device last used for start up.
- If no start up device is selected, the Operating System will start up in the order of the settings of the [Boot] menu in the Setup Utility during subsequent start ups.
- When you want to change the settings in the Setup Utility, select <Enter Setup> from the menu.

# Starting Up/Shutting Down

- If security indicator (🔑) is displayed, you must first enter your password. (📖 Reference Manual "Security Measures")

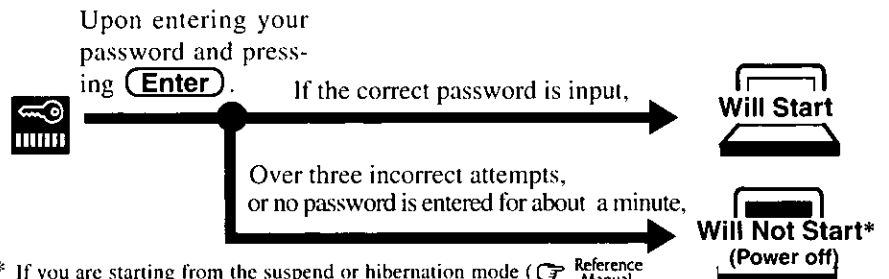

\* If you are starting from the suspend or hibernation mode (📖 Reference Manual "Suspend/Hibernation Functions"), if after three attempts the correct password is not input, or if no password is entered for about a minute, the computer returns to the suspend or hibernation mode.

- When an application or file that was previously displayed appears on your screen, the suspend or hibernation function has been set. (📖 Reference Manual "Suspend/Hibernation Functions")

### 3 Select your application

You are able to start working on your computer.

#### NOTE

- The power saving function is factory set, so if there is no input from a key, the touch pad, or the touchscreen for two minutes. The LCD is powered off (ECO mode). The LCD will resume operation when the touch pad or the touchscreen is used or a key is pressed. We recommend using a key that will not result in an input from the keyboard, such as **Shift**.
- [System Devices] in [Start] - [Settings] - [Control Panel] - [System] - [Device Manager] may contain a device or devices bearing an exclamation mark or question mark. This does not indicate a malfunction. Such a mark (exclamation or question mark) will not be displayed if the operating environment of the device showing the mark is corrected, by for instance installing the driver of the device.

## Shutting Down (power off your computer)

This procedure is shutting down without using the suspend or hibernation function. (📖 Reference Manual "Suspend/Hibernation Functions")

### 1 Display the shut down screen

After saving important data and closing each application, select [Shut Down] from the [Start] menu.

#### NOTE

From the keyboard,

You may choose to press down on , then select the menu with  or .

### 2 Confirm shut down

Select [Shut down], then press [OK]. Your computer will power off automatically. (In the OFF state, if you are not recharging your battery pack or if the pack is fully charged, your computer consumes approximately 1.5 W.)

- **Restarting your computer (without shutting down)**

Select [OK] after selecting [Restart].

#### NOTE

To quickly resume computer operation after shutting down,

The suspend or hibernation function is available. (📖 Reference Manual "Suspend/Hibernation Functions")



# List of Error Codes

The following is a list of the messages that BIOS can display. Most of them occur during POST. Some of them display information about a hardware device, e.g., the amount of memory installed. Others may indicate a problem with a device, such as the way it has been configured. Following the list are explanations of the messages and remedies for reported problems.

If your system displays one of except the messages marked below with an asterisk (\*), write down the message and contact Panasonic Technical Support. If your system fails after you make changes in the Setup menus, reset the computer, enter Setup and install Setup defaults or correct the error.

## **0200 Failure Fixed Disk**

Fixed disk in not working or not configured properly. Check to see if fixed disk is attached properly. Run Setup. Find out if the fixed-disk type is correctly identified.

## **0210 Stuck key**

Stuck key on keyboard.

## **0211 Keyboard error**

Keyboard not working.

## **0212 Keyboard Controller Failed**

Keyboard controller failed test. May require replacing keyboard controller.

## **0213 Keyboard locked - Unlock key switch**

Unlock the system to proceed.

## **0230 Shadow RAM Failed at offset : *nnnn***

Shadow RAM failed at offset *nnnn* of the 64k block at which the error was detected.

## **0231 System RAM Failed at offset : *nnnn***

System RAM failed at offset *nnnn* of in the 64k block at which the error was detected.

## **0232 Extended RAM Failed at offset : *nnnn***

Extended memory not working or not configured properly at offset *nnnn*.

## **0250 System battery is dead - Replace and run SETUP**

The CMOS clock battery indicator shows the battery is dead. Replace the battery and run Setup to reconfigure the system.

## **\*0251 System CMOS checksum bad - Default configuration used**

System CMOS has been corrupted or modified incorrectly, perhaps by an application program that changes data stored in CMOS. The BIOS installed Default SETUP Values. If you do not want these values, enter Setup and enter your own values. If the error persists, check the system battery or contact Panasonic Technical Support.

## **0260 System timer error**

The timer test failed. Requires repair of system board.

## **0270 Real time clock error**

Real-time clock fails BIOS test. May require board repair.

## **\*0280 Previous boot incomplete - Default configuration used**

Previous POST did not complete successfully. POST loads default values and offers to run Setup. If the failure was caused by incorrect values and they are not corrected, the next boot will likely fail. On systems with control of wait states, improper Setup settings can also terminate POST and cause this error on the next boot. Run Setup and verify that the wait-state configuration is correct. This error is cleared the next time the system is booted.

## **0281 Memory Size found by POST differed from CMOS**

Memory size found by POST differed from CMOS.

## **02B0 Diskette drive A error**

## **02B1 Diskette drive B error**

Drive A: or B: is present but fails the BIOS POST diskette tests. Check to see that the drive is defined with the proper diskette type in Setup and that the diskette drive is attached correctly.

## **02B2 Incorrect Drive A type - run SETUP**

Type of floppy drive A: not correctly identified in Setup.

## **02B3 Incorrect Drive B type - run SETUP**

Type of floppy drive B: not correctly identified in Setup.

## **02D0 System cache error - Cache disabled**

Contact Panasonic Technical Support.

## **02F0: CPU ID:**

CPU socket number for Multi-Processor error.

## **02F4: EISA CMOS not writable**

ServerBIOS2 test error: Cannot write to EISA CMOS.

# List of Error Codes

## **02F5: DMA Test Failed**

ServerBIOS2 test error: Cannot write to extended DMA (Direct Memory Access) registers.

## **02F6: Software NMI Failed**

ServerBIOS2 test error: Cannot generate software NMI (Non-Maskable Interrupt).

## **02F7: Fail - Safe Timer NMI Failed**

ServerBIOS2 test error: Fail-Safe Timer takes too long.

## **device address Conflict**

Address conflict for specified *device*.

## **Allocation Error for: device**

Run ISA or EISA Configuration Utility to resolve resource conflict for the specified *device*.

## **CD ROM Drive**

CD ROM Drive identified.

## **Entering SETUP ...**

Starting Setup Utility.

## **Failing Bits : nnnn**

The hex number *nnnn* is a map of the bits at the RAM address which failed the memory test. Each 1 (one) in the map indicates a failed bit. See error 230,231 or 232 for offset address of the failure in System, Extended or Shadow memory.

## **Fixed Disk n**

Fixed disk *n* (0-3) identified.

## **Invalid System Configuration Data**

Problem with NVRAM (CMOS) data.

## **I/O device IRQ conflict**

I/O device IRQ conflict error.

## **PS/2 Mouse Boot Summary Screen:**

PS/2 Mouse installed.

## **nnnn kB Extended RAM Passed**

Where *nnnn* is the amount of RAM in kilobytes successfully tested.

## **nnnn Cache SRAM Passed**

Where *nnnn* is the amount of system cache in kilobytes successfully tested.

## **nnnn kB Shadow RAM Passed**

Where *nnnn* is the amount of shadow RAM in kilobytes successfully tested.

## **nnnn kB System RAM Passed**

Where *nnnn* is the amount of system RAM in kilobytes successfully tested.

## **Operating System not found**

Operating system cannot be located on either drive A: or drive C:. Enter Setup and see if fixed disk and drive A: are properly identified.

## **Parity Check 1 nnnn**

Parity error found in the system bus. BIOS attempts to locate the address and display it on the screen. If it cannot locate the address, it displays ????. Parity is a method for checking errors in binary data. A parity error indicates that some data has been corrupted.

## **Parity Check 2 nnnn**

Parity error found in the I/O bus. BIOS attempts to locate the address and display it on the screen. If it cannot locate the address, it displays ????.

## **Press <F1> to resume, <F2> to Setup, <F3> for previous**

Displayed after any recoverable error message. Press <F1> to start the boot process or <F2> to enter a Setup and change the settings. Press <F3> to display the previous screen (usually an initialization error of an **Option ROM**, i.e., an add-on card). Write down and follow the information shown on the screen.

## **Press <F2> to enter Setup**

Optional message displayed during POST. Can be turned off in Setup.

## **PS/2 Mouse:**

PS/2 mouse identified.

## **System BIOS shadowed**

System BIOS copied to shadow RAM.

## **UMB upper limit segment address : nnnn**

Displays the address *nnnn* of the upper limit of **Upper Memory Blocks**, indicating released segments of the BIOS which can be reclaimed by a virtual memory manager.





## **Video BIOS shadowed**

Video BIOS successfully copied to shadow RAM.

# Dealing With Problems (Summary)

When a problem occurs, please refer to this page. The Reference Manual also contains detailed information. If you still cannot troubleshoot the problem, please contact Panasonic Technical Support.

## ● Starting Up

The power indicator or battery indicator is not lit	<ul style="list-style-type: none"> <li>● Check the cable connection for the AC adapter.</li> <li>● Check to see if a fully charged battery is properly installed.</li> <li>● Remove the battery pack and disconnect the AC adapter, then connect them again.</li> </ul>
 is displayed	Please input your password. If you have forgotten it, contact Panasonic Technical Support.
[POST Startup Error(s)] is displayed	 page 17
Windows startup, or an operation is extremely slow	Press <b>(F9)</b> in the Setup Utility (  <small>Reference Manual</small> "Setup Utility"). This will restore the Setup Utility's settings to their default values (except the password settings). Then, the Setup Utility must be run once again for you to input the appropriate operating environment settings. (The processing speed depends on the application software used, so this operation may not cause the processing speed to increase.)
The date and time are incorrect	<ul style="list-style-type: none"> <li>● You can set the date and time through [Date/Time] in [Start] - [Settings] - [Control Panel].</li> <li>● When the computer is connected to a Local Area Network (LAN), please confirm the date and time of the server.</li> <li>● If you continue to experience problems, the internal battery maintaining the clock may need to be replaced. Please contact Panasonic Technical Support.</li> </ul>
When the previous item is not the cause	<ul style="list-style-type: none"> <li>● Press <b>(F9)</b> in the Setup Utility ( <small>Reference Manual</small> "Setup Utility"). This will restore the Setup Utility's settings to their default values (except the password settings).</li> <li>● In the MS-DOS mode, run SCANDISK to check the hard disk.</li> <li>● At start-up, press <b>(F8)</b> to operate the computer in the Safe mode.</li> <li>● Try removing all peripheral devices.</li> </ul>

## ● Shutting down



Unable to shut down Windows 95	If a USB device is connected, try removing it.
--------------------------------	--

## ● Battery Indicator

The red indicator lights. Repeated beeping sound while the computer is in use.	The battery level is low. Save your data and power off your computer. After connecting the AC adapter or replacing the battery pack with a fully charged one, turn your computer on.
The red indicator blinks	<ul style="list-style-type: none"> <li>● The battery pack or recharging function may be defective. Quickly remove the battery pack and disconnect the AC adapter, then connect them again.</li> <li>● If the problem persists, contact Panasonic Technical Support.</li> </ul>
After the AC adapter is connected, the orange indicator blinks five times	Unable to charge because of an improper temperature range. (  page 6)

# Dealing With Problems (Summary)

## ● Display

<p><b>No display after powering on</b></p>	<ul style="list-style-type: none"> <li>● At the time of purchase, the display setting is preset for an external display. If you connect an external display, the screen is displayed on the external display.</li> <li>● When there is no display to an external display,             <ul style="list-style-type: none"> <li>• Check your cable connection to the external display.</li> <li>• Confirm your display is powered on.</li> <li>• Check the settings for your external display.</li> </ul> </li> <li>● Try changing the display by pressing <b>(Fn) + (F3)</b>.</li> <li>● When displaying only through an external display, if the computer is shut down by using the suspend or hibernation function, there will be no display on the LCD unless the external display is connected when operations are resumed. In this case, connect the external display.</li> </ul>
<p><b>The power has not been turned off, but after a certain period of time, there is no display</b></p>	<ul style="list-style-type: none"> <li>● Has the computer been set to the power-saving mode? To resume operation of your computer from ECO mode, press any key.</li> <li>● To save power, your computer may have automatically entered the suspend or hibernation mode. (  Reference Manual "Computing On the Road" )</li> </ul>
<p><b>The resolution of the display cannot be changed</b></p>	<p>Set [None] for [Wallpaper] in [Start] - [Settings] - [Control Panel] - [Display] - [Background], and then press [OK]. Then, once again try changing the resolution. After the change, be sure to restart the computer.</p>
<p><b>An afterimage appears (i.e., green, red, and blue dots remain on the display) or there are dots not displaying the correct colors</b></p>	<p>If an image is displayed for a prolonged period of time, an afterimage may appear. This is not a malfunction. The afterimage will disappear when a different screen is displayed. High-precision and advanced technologies are necessary in the production of color liquid crystal displays (color LCDs). Therefore, if 99.998% or more of the picture elements are functioning properly, no defect is considered to exist.</p>
<p><b>The motion of the mouse cursor is not smooth</b></p>	<p>Select [Start] - [Settings] - [Control Panel] - [Mouse] - [Motion] and try to change the speed or acceleration.</p>
<p><b>The cursor cannot be controlled</b></p>	<p>Restart the computer by using the keyboard (e.g., ).</p>
<p><b>During simultaneous display, the screen of the external display becomes disordered</b></p>	<p>Try changing the display by pressing <b>(Fn) + (F3)</b>.</p>
<p><b>The external display no longer displays properly</b></p>	<p>When an external display not compatible with the power saving mode is used with the computer, the external display may no longer display properly when the computer enters the ECO mode. In such cases, turn off the power to the external display.</p>

# Reinstalling Software

## Before Reinstallation

### ● Preparing

- You will need the Product Recovery CD-ROM and the BACKUP DISK (e.g., FIRTAID FD) you made earlier. (☞ page 12)

#### NOTE

If you have not created the BACKUP DISK, you can create by selecting [Create BACKUP DISK] in [Start] - [Programs] - [Panasonic]. If you can not create this disk, please contact Panasonic Technical Support.

- The SuperDisk Drive Pack (CF-VFS371) is required for the following reinstallation procedure. (☞ Reference Manual "SuperDisk Drive")

### ● Important

- Save all important data. If reinstallation is carried out, all data existing prior to the installation will be lost. The reinstallation will return the computer to the conditions at time of purchase.
- Before the reinstallation procedure, remove all peripherals (except for the CD-ROM/DVD-ROM drive).
- Be sure the AC adapter is connected until the reinstallation procedure is completed.
- When the computer enter the ECO mode, the computer to the LCD is automatically cut. In this case, perform the touch pad operation.

## Reinstalling

### ● Windows 95

#### CAUTION

If data on your hard disk is compressed, the data should be uncompressed.

- 1 Turn the computer on.
- 2 When the message [Press <F2> to enter SETUP] is displayed, press **(F2)** and then run the Setup Utility. If the password has been set, enter the supervisor password.
- 3 Press **(F9)**.  
At the confirmation message, select [Yes] and press **(Enter)**.
- 4 Select [Boot] menu, press **(F5)/(F6)** and **(↑)/(↓)** until [CD-ROM/DVD-ROM] is at the top of the [Boot] menu and [ATAPI Removable] is the next position.
- 5 Set the Product Recovery CD-ROM in the CD-ROM drive.
- 6 Press **(F10)**.  
At the confirmation message, select [Yes] and press **(Enter)**. The computer will reboot, and this screen should appear.

Select the number

1. Restore the whole HDD to factory default
2. Restore the drive C to factory default
3. End

- 7 Make a selection from the menu.

**To restore all contents of the hard disk to factory default, including the partition setting(s):**

Select [1. Restore the whole HDD to factory default].

**To restore the hard disk (C drive) to factory default, excluding the partition setting(s):**

Select [2. Restore the drive C to factory default].

- 8 At the confirmation message, press **(Y)**.  
The operations of "format" and "restore" for the hard disk start automatically. (The operations take about one hour.)

- 9 After the "restore" procedure completes, remove the Product Recovery CD-ROM, then close the tray.
- 10 Turn the computer off by sliding the power switch and remove the CD-ROM drive.
- 11 Set the SuperDisk drive pack in the multimedia pocket, set the FIRTAID FD and turn the computer on. Follow the on-screen instructions.
- 12 After the reinstallation procedure completes, the following message will appear on the display.

All data on the whole HDD has been restored to the factory default. After removing floppy disk, restart the computer and set up Windows again.

Restart the computer by pressing **(Ctrl) + (Alt) + (Del)**.

- 13 When the message [Press <F2> to enter SETUP] is displayed, press **(F2)** and then run the Setup Utility. If the password has been set, enter the supervisor password.
- 14 Press **(F9)**.  
At the confirmation message, select [Yes] and press **(Enter)**.
- 15 Press **(F10)**.  
At the confirmation message, select [Yes] and press **(Enter)**.
- 16 Perform the setup procedure for Windows 95 by following the instructions on the screen. (☞ page 11)

#### NOTE

If necessary, set the CD-ROM drive in the multimedia pocket (☞ Reference Manual "Multimedia Pocket").

# LIMITED USE LICENSE AGREEMENT

THE SOFTWARE PROGRAM(S) ("PROGRAMS") FURNISHED WITH THIS PANASONIC® PRODUCT ("PRODUCT") ARE LICENSED ONLY TO THE END-USER ("YOU"), AND MAY BE USED BY YOU ONLY IN ACCORDANCE WITH THE LICENSE TERMS DESCRIBED BELOW. YOUR USE OF THE PROGRAMS SHALL BE CONCLUSIVELY DEEMED TO CONSTITUTE YOUR ACCEPTANCE OF THE TERMS OF THIS LICENSE.

Matsushita Electric Industrial Co., Ltd. ("MEI") has developed or otherwise obtained the Programs and hereby licenses their use to you. You assume sole responsibility for the selection of the Product (including the associated Programs) to achieve your intended results, and for the installation, use and results obtained therefrom.

## LICENSE

- A. MEI hereby grants you a personal, non-transferable and non-exclusive right and license to use the Programs in accordance with the terms and conditions stated in this Agreement. You acknowledge that you are receiving only a LIMITED LICENSE TO USE the Programs and related documentation and that you shall obtain no title, ownership nor any other rights in or to the Programs and related documentation nor in or to the algorithms, concepts, designs and ideas represented by or incorporated in the Programs and related documentation, all of which title, ownership and rights shall remain with MEI or its suppliers.
- B. You may use the Programs only on the single Product which was accompanied by the Programs.
- C. You and your employees and agents are required to protect the confidentiality of the Programs. You may not distribute or otherwise make the Programs or related documentation available to any third party, by time-sharing or otherwise, without the prior written consent of MEI.
- D. You may not copy or reproduce, or permit to be copied or reproduced, the Programs or related documentation for any purpose, except that you may make one (1) copy of the Programs for backup purposes only in support of your use of the Programs on the single Product which was accompanied by the Programs. You shall not modify, or attempt to modify, the Programs.
- E. You may transfer the Programs and license them to another party only in connection with your transfer of the single Product which was accompanied by the Programs to such other party. At the time of such a transfer, you must also transfer all copies, whether in printed or machine readable form, of every Program, and the related documentation, to the same party or destroy any such copies not so transferred.
- F. You may not remove any copyright, trademark or other notice or product identification from the Programs and you must reproduce and include any such notice or product identification on any copy of any Program.

YOU MAY NOT REVERSE ASSEMBLE, REVERSE COMPILE, OR MECHANICALLY OR ELECTRONICALLY TRACE THE PROGRAMS, OR ANY COPY THEREOF, IN WHOLE OR IN PART.

YOU MAY NOT USE, COPY, MODIFY, ALTER, OR TRANSFER THE PROGRAMS OR ANY COPY THEREOF, IN WHOLE OR IN PART, EXCEPT AS EXPRESSLY PROVIDED IN THE LICENSE.

IF YOU TRANSFER POSSESSION OF ANY COPY OF ANY PROGRAM TO ANOTHER PARTY, EXCEPT AS PERMITTED IN PARAGRAPH E ABOVE, YOUR LICENSE IS AUTOMATICALLY TERMINATED.

## TERM

This license is effective only for so long as you own or lease the Product, unless earlier terminated. You may terminate this license at any time by destroying, at your expense, the Programs and related documentation together with all copies thereof in any form. This license will also terminate effective immediately upon occurrence of the conditions therefor set forth elsewhere in this Agreement, or if you fail to comply with any term or condition contained herein. Upon any such termination, you agree to destroy, at your expense, the Programs and related documentation together with all copies thereof in any form.

YOU ACKNOWLEDGE THAT YOU HAVE READ THIS AGREEMENT, UNDERSTAND IT AND AGREE TO BE BOUND BY ITS TERMS AND CONDITIONS. YOU FURTHER AGREE THAT IT IS THE COMPLETE AND EXCLUSIVE STATEMENT OF THE AGREEMENT BETWEEN US, WHICH SUPERSEDES ANY PROPOSAL OR PRIOR AGREEMENT, ORAL OR WRITTEN, AND ANY OTHER COMMUNICATIONS BETWEEN US, RELATING TO THE SUBJECT MATTER OF THIS AGREEMENT.

# Contrat de licence d'usage limité

Le(s) logiciel(s) (les "Logiciels") fournis avec ce produit Panasonic® (le "Produit") sont exclusivement concédés en licence à l'utilisateur ultime ("vous"), et ils ne peuvent être utilisés que conformément aux clauses contractuelles ci-dessous. En utilisant les logiciels, vous vous engagez de manière définitive à respecter les termes, clauses et conditions des présentes.

Matsushita Electric Industrial Co., Ltd. ("MEI") a mis au point ou obtenu les Logiciels et vous en concède l'utilisation par les présentes. Vous assumez l'entière responsabilité du choix de ce Produit (y compris des Logiciels associés) pour obtenir les résultats escomptés, ainsi que de l'installation, de l'utilisation et des résultats obtenus.

## Licence

- A. MEI vous octroie par les présentes le droit et la licence personnels, non cessibles et non exclusifs d'utiliser les Logiciels conformément aux termes, clauses et conditions de ce Contrat. Vous reconnaissez ne recevoir qu'un droit limité d'utiliser les Logiciels et la documentation les accompagnant et vous vous engagez à n'obtenir aucun droit de titre, propriété ni aucun autre droit vis-à-vis des Logiciels et de la documentation les accompagnant ni vis-à-vis des algorithmes, concepts, dessins, configurations et idées représentés par ou incorporés dans les Logiciels et la documentation les accompagnant, dont les titres, propriété et droits resteront tous à MEI ou à leurs propriétaires.
- B. Vous ne pouvez utiliser les Logiciels que sur le Produit unique qui est accompagné par les Logiciels.
- C. Vous et vos employés ou agents êtes requis de protéger la confidentialité des Logiciels. Vous ne pouvez ni distribuer ni mettre les Logiciels et la documentation les accompagnant à la disposition d'un tiers, par partage de temps ou de quelque autre manière que ce soit, sans l'autorisation écrite préalable de MEI.
- D. Vous ne pouvez ni copier ni reproduire ni permettre la copie ni la reproduction des Logiciels ni de la documentation les accompagnant pour quelque fin que ce soit, à l'exception d'une (1) copie des Logiciels à des fins de sauvegarde uniquement pour soutenir votre utilisation des Logiciels sur le Produit unique qui est accompagné par les Logiciels. Vous ne pouvez ni modifier ni tenter de modifier les Logiciels.
- E. Vous ne pouvez céder les Logiciels et en octroyer la licence à une autre partie qu'en rapport avec votre cession du Produit unique qui est accompagné par les Logiciels à cette autre partie. Au moment de cette cession, vous devez céder également toutes les copies, que ce soit sous forme imprimée ou lisible par la machine, de tous les Logiciels ainsi que de la documentation les accompagnant, à la même partie ou détruire les copies non cédées.
- F. Vous ne pouvez retirer aucune marque de droits d'auteur, marque ou autre ni aucune identification de produit des Logiciels et vous devez reproduire et inclure toutes ces notices ou identifications de produit sur toutes les copies des Logiciels.

Vous ne pouvez assembler en sens inverse, compiler en sens inverse ni retracer les Logiciels ni aucune de leurs copies, de façon électronique ou mécanique, en tout ou en partie.

Vous ne pouvez utiliser, copier, modifier, altérer ni céder les Logiciels ni aucune de leurs copies, en tout ou en partie, à l'exception de ce qui est expressément stipulé dans ce contrat.

Si vous cédez la possession de toute copie ou de tout Logiciel à une autre partie, à l'exception de ce qui est autorisé au paragraphe E ci-dessus, votre licence est automatiquement résiliée.

## Termes, clauses et conditions

Cette licence n'est effective que pour la durée de possession ou de crédit-bail du Produit, à moins d'une résiliation antérieure. Vous pouvez résilier cette licence à tout moment en détruisant, à vos frais, les Logiciels et la documentation les accompagnant avec toutes leurs copies, sous quelque forme que ce soit. Cette licence sera également résiliée, avec application immédiate, si les conditions de résiliation définies ailleurs dans ce contrat se sont réalisées ou si vous ne respectez pas les termes, clauses et conditions qui y sont contenues. Au moment de la résiliation, vous acceptez de détruire, à vos frais, les Logiciels et la documentation les accompagnant avec toutes leurs copies, sous quelque forme que ce soit.

Vous reconnaissez avoir lu ce contrat, en avoir compris toute la substance et avoir accepté de respecter ses termes, clauses et conditions. Vous reconnaissez en outre qu'ils sont la description complète et exclusive du contrat conclu entre nous, contrat qui remplace et annule toute proposition ou contrat précédent, écrit ou oral, et toute autre communication entre nous, relativement à l'objet du présent contrat.

# Names and Functions of Parts

## Function Keys

(☞ Reference Manual "Key Combinations")

## Touch Pad

☞ page 13

## LED Indicators

(☞ Reference Manual "LED Indicators")

## Battery Indicator

(☞ Reference Manual "LED Indicator")

## POWER Indicator

(☞ Reference Manual "LED Indicator")

## Power Switch

POWER ▶

Before using the computer for the first time, carefully read the [LIMITED USE LICENSE AGREEMENT]. If you agree to the conditions, remove the seal.

## PC Card Slots

(☞ Reference Manual "PC Cards")

## External Keyboard/Mouse Port



## Serial Port



Use this port to a serial mouse or serial communication devices.

## Parallel Port



(☞ Reference Manual "Printer")

## External Display Port



(☞ Reference Manual "External Display")

## Tilt Stand

(☞ Reference Manual "Multimedia Pocket")

## RAM Module

(☞ Reference Manual "RAM Module")

## LCD

(☞ Reference Manual "Touch Pad (Advanced)", "Touchscreen")

## Ventilation Hole

These holes allow heat to exit.

## CAUTION

Do not block or place the computer in a location that may prevent proper ventilation.

## DC-IN Jack



DC IN  
15.6V

## Microphone Jack



Use only a monaural condenser microphone (miniature jack). Using an input source other than a monaural condenser microphone may not allow audio to be input or may damage the equipment.

## Headphone Jack



Use this jack to connect headphones or amplifier-equipped speakers. Audio output from the internal speaker is disabled when headphones or external speakers are connected.

## Infrared Communication Port

(☞ Reference Manual "Infrared Data Communications")

## USB Port



(☞ Reference Manual "USB Devices")

## Internal Modem



(☞ Reference Manual "Modem")

## CD-ROM Drive (Multimedia Pocket)

(☞ Reference Manual "CD-ROM/DVD-ROM Drive", "Multimedia Pocket")

## Battery Pack

(☞ Reference Manual "Battery Power")

## Hard Disk Drive

(☞ Reference Manual "Hard Disk Drive")



# Specifications

## ● Main Specifications

<b>Model No.</b>		CF-37VB62AAM
<b>CPU</b>		Intel® Mobile Celeron™ 366 MHz L1 Cache Memory: 32 KB      L2 (Second) Cache Memory: 128 KB
<b>Memory (Expandable to)</b>		64 MB (192 MB Max. )
<b>Video Memory</b>		4 MB
<b>LCD</b>	<b>Type</b>	12.1 Type(TFT)
	<b>Displayed Colors*<sup>1</sup></b>	256/65536/262144 colors (640 x 480 dots/800 x 600 dots)
<b>Hard Disk Drive (including about 200 MB used specifically by the system)</b>		6.4 GB* <sup>2</sup>

\*<sup>1</sup> A 16M color display on the LCD is achieved by using the dithering function.

\*<sup>2</sup> 1GB = 10<sup>9</sup> bytes

## ● Other Specifications

<b>Keyboard</b>	Windows 95 keyboard (87 keys)			
<b>Pointing Device</b>	Touch Pad Touchscreen (Anti-Reflection, Finger touch capable)			
<b>CD-ROM Drive</b>	24x Speed (Max.)			
<b>Slots</b>	PC Card Slot	Type I or Type II		
		Allowable current	3.3 V: 400 mA, 5 V: 400 mA	
	RAM Module Slot	144-pin, SO-DIMM, 3.3 V, SDRAM		
<b>Interface</b>	Parallel Port	Dsub 25-pin female		
	External Display Port	Mini Dsub 15-pin female		
	Serial Port	Dsub 9-pin male		
	Microphone Jack* <sup>1</sup>	Miniature jack, 3.5 DIA Input impedance 600 Ω, Input voltage range 0.01 V p-p		
	Headphone Jack	Miniature jack, 3.5 DIA Impedance 32 Ω, Output Power 4 mW (Impedance 32 Ω) x 2		
	Infrared Communication Port	IrDA 1.1 compliant, 4 Mbps data transmission speed* <sup>2</sup>		
	External Keyboard/Mouse Port	Mini DIN 6-pin female		
	USB Port	4-pin		
	Internal Modem	Data:56 kbps (V.90 & K56flex) FAX:14.4 kbps		
<b>Speaker</b>	Stereo Speaker (built in)			
<b>Sound</b>	16 bits, 44.1 kHz AC '97 2.1 Compatible			
<b>Software</b>	Operating System	Microsoft® Windows® 95 (FAT32 File System)		
	Utility Programs	Setup Utility, DMI Viewer, Panasonic Hand Writing, Panasonic Battery Monitor, Smart Boot, Display Rotation Tool		
<b>Battery</b>	Battery Pack	Lithium ion 10.8 V, 3.0 Ah		
	Operating Time	Approx. 1.0 - 4.0 h* <sup>3</sup>		
	Charging Time	Power On	Approx. 5.5 h* <sup>3</sup>	
		Power Off	Approx. 2.5 h* <sup>3</sup>	
	Clock Battery	Coin type lithium battery 3.0 V		
Operating Time		Approx. 7 years		
<b>AC Adapter*<sup>4</sup></b>	Input	100 V - 240 V AC, 50 Hz / 60 Hz	Output 15.6 V DC, 3.85 A	
<b>Power Consumption</b>	Approx. 49 W* <sup>5</sup> (maximum when recharging in the ON state)			
<b>Physical Dimensions (W X H X D)</b>	297 mm X 25.6 mm (front of computer) or 27.9 mm (rear of computer) X 236.5 mm (11.7 " X 1.0 " or 1.1 " X 9.3 ") (excluding the rear height adjustment parts)			
<b>Weight</b>	Approx. 2.0 kg {Approx. 4.5 lb.} (including the CD-ROM drive)			

\*<sup>1</sup> Use only a monaural condenser microphone (miniature jack).

\*<sup>2</sup> A communications software is necessary.

\*<sup>3</sup> Varies depending on the usage conditions.

\*<sup>4</sup> The AC adapter is compatible with power sources up to 240 V AC.

This computer is supplied with a 125 V AC compatible AC cord.

\*<sup>5</sup> Approx. 1.5 W when the battery pack is fully charged (or not being charged) and the computer is OFF.

# LIMITED WARRANTY

**For U.S.A.**

## **PANASONIC PERSONAL COMPUTER AND PERIPHERALS LIMITED WARRANTY**

Panasonic Personal Computer Company (referred to as "Panasonic") will repair this product (other than software, which is covered by a separate warranty) with new or rebuilt parts, free of charge in the U.S.A. for three (3) years from the date of original purchase in the event of a defect in materials or workmanship. This warranty includes the AC Adapter but excludes the batteries and all other options and accessories which are covered for a period of one (1) year from the date of purchase.

This warranty is extended solely to the original purchaser. A purchase receipt or other proof of date of original purchase will be required before warranty performance is rendered.

This warranty only covers failures due to defects in materials or workmanship which occur during normal use. It does not cover damage which occurs in shipment or failures which are caused by products not supplied by Panasonic, or failures which result from alteration, accident, misuse, introduction of liquid or other foreign matter into the unit, abuse, neglect, installation, maladjustment of consumer controls, improper maintenance, modification or service by anyone other than a Factory Service Center or authorized Panasonic Service Dealer, or damage that is attributable to acts of God.

### **Limits and Exclusions:**

There are no other express warranties except as listed below.

PANASONIC SHALL NOT BE LIABLE FOR LOSS OF DATA OR OTHER INCIDENTAL OR CONSEQUENTIAL DAMAGES RESULTING FROM THE USE OF THIS PRODUCT, OR ARISING OUT OF ANY BREACH OF THIS WARRANTY. ALL EXPRESS AND IMPLIED WARRANTIES, INCLUDING THE WARRANTIES OF MERCHANTABILITY AND FITNESS FOR A PARTICULAR PURPOSE ARE LIMITED TO THE APPLICABLE WARRANTY PERIOD SET FORTH ABOVE. Some states do not allow the exclusion or limitation of incidental or consequential damages, or limitations on how long an implied warranty lasts, so the above limitations or exclusions may not apply to you.

This limited warranty gives you specific legal rights, and you may also have other rights which vary from state to state. If a problem with your product develops during or after the warranty period, you may contact our representatives at 1-800-LAPTOP5. If the problem is not handled to your satisfaction, then write to the Consumer Affairs Division at the address indicated below.

### **SOFTWARE LIMITED WARRANTY**

Panasonic Personal Computer Company (referred to as "Panasonic") warrants to you only that the disk(s) or other media on which the Programs are furnished will be free from defects in materials and workmanship under normal use for a period of sixty (60) days from the date of delivery thereof to you, as evidenced by your purchase receipt.

This is the only warranty Panasonic makes to you. Panasonic does not warrant that the functions contained in the Programs will meet your requirements or that the operation of the Programs will be uninterrupted or error free.

Panasonic's entire liability, and your exclusive remedy under this warranty shall be limited to the replacement, in the United States, of any defective disk or other media which is returned to Panasonic's Authorized Service Center, together with a copy of the purchase receipt, within the aforesaid warranty period.

Anything in the foregoing to the contrary notwithstanding, Panasonic shall have no obligation for any defects in the disk(s) or other media on which the Programs are furnished resulting from your storage thereof, or for defects that have been caused by operation of the disk(s) or other media otherwise than on the Product or in environmental conditions other than those specified by Panasonic by alteration, accident, misuse, abuse, neglect, mishandling, misapplication, installation, maladjustment of consumer controls, improper maintenance, modification of damage that is attributable to acts of God. In addition, Panasonic shall have no obligation for any defects in the disk(s) or other media if you have modified, or attempted to modify any Program.

DURATION OF IMPLIED WARRANTIES, IF ANY, IS LIMITED TO SIXTY (60) DAYS.

PANASONIC ASSUMES NO RISK OF AND SHALL NOT IN ANY CASE BE LIABLE FOR ANY DAMAGES, INCLUDING, WITHOUT LIMITATION, ANY SPECIAL, INCIDENTAL, CONSEQUENTIAL, OR PUNITIVE DAMAGES ARISING FROM BREACH OF WARRANTY OR CONTRACT, NEGLIGENCE OR ANY OTHER LEGAL THEORY, INCLUDING, WITHOUT LIMITATION LOSS OF GOODWILL, PROFITS OR REVENUE, LOSS OF USE OF THE PROGRAMS OR PRODUCTS OR ANY ASSOCIATED EQUIPMENT, COST OF CAPITAL, COST OF ANY SUBSTITUTE EQUIPMENT, FACILITIES, SERVICES, DOWNTIME COSTS, OR CLAIMS OF ANY PARTY DEALING WITH YOU FOR SUCH DAMAGES.

Some states do not allow the exclusion or limitation of incidental or consequential damages, or limitations on how long an implied warranty lasts, so the above limitations or exclusions may not apply to you.

This limited warranty gives you specific legal rights, and you may also have other rights which vary from state to state.

This Limited Warranty will be governed by the laws the State of New York, without regard to its conflict-of-laws rules.

\* \* \*

To obtain service or technical assistance within the continental U.S.A. and Alaska.

**DIAL TOLL FREE: 1-800-LAPTOP5**

Correspondence requesting product information should be sent to: Panasonic Personal Computer Company, 50 Meadowlands Parkway, Panazip 2F-5, Secaucus, NJ 07094

## For Canada

### PANASONIC COMPUTER AND PERIPHERALS LIMITED WARRANTY

**Coverage** – Panasonic Canada Inc. ("PCI") warrants to you, the first end user customer, this computer product (excluding software media), when purchased from PCI or from a PCI authorized reseller, to be free from defects in materials and workmanship under normal use, subject to the terms set forth below, during the period of warranty coverage specified.

Scope of Coverage	Period of Coverage	Type of Failure Coverage
Whole Product (except Batteries), AC Adapter, CD-ROM (if factory installed), Port Replicator, Extra Memory Modules and all other Options and Accessories	Three (3) Years from Date of Original End User Customer Purchase	Defective Materials or Workmanship
Batteries, CD-ROM (unless factory installed), Port Replicator, Extra Memory Modules and all other Peripherals, Options and Accessories	One (1) Year from Date of Original End User Customer Purchase	Defective Materials or Workmanship

**Remedy** – In the event of a warranty claim, contact PCI's representatives within the applicable warranty period, identifying the nature of the defect claimed, at 1-800-668-8386 between 9:00 A.M. and 5:00 P.M., Eastern Time Zone, Mon. – Fri. (excluding holidays) for instructions on how to obtain service. A purchase receipt or other proof of date of original purchase is required before warranty service is performed. Defective parts covered by this Limited Warranty will be repaired or replaced with new or comparable rebuilt parts on an exchange basis. Warranty replacement or repair is subject to the terms of this Limited Warranty for the balance of the original period of warranty coverage.

**No Coverage** – This Limited Warranty does not cover products purchased outside Canada. Neither does it cover damage to, failure of, or defects in a product or accessory through mishandling, improper installation, abnormal use, misuse, neglect, accident, introduction of liquid or other foreign matter into the product, alteration or servicing by anyone not authorized by PCI, or act of God.

#### **IF YOU SHIP THE PRODUCT FOR WARRANTY SERVICE**

Carefully pack the product, preferably in the original carton. Include details of defect claimed and proof of date of original purchase. No liability is assumed for loss or damage to the product while in transit, if you chose your own transportation carrier.

### SOFTWARE MEDIA LIMITED WARRANTY

**Coverage** - Panasonic Canada Inc. ("PCI") warrants to you, the first end user customer, that the disk(s) or other media on which software program(s) is/are supplied will be free from defects in materials and workmanship under normal use in Canada for a period of sixty (60) days from date of receipt as evidenced by your purchase receipt for your Panasonic Computer product.

THIS IS THE ONLY WARRANTY THAT PCI MAKES RESPECTING THE SOFTWARE MEDIA. PCI does not warrant the software. Please refer to the software licensor's written warranty (accompanying the copy of the software) for any software warranty claim.

**Claim Procedure** – In the event of a defect in material or workmanship in the media during the sixty (60) day warranty period, and you return it, transportation costs prepaid, to Panasonic Canada Inc., Computer Products Marketing, at the above address, within the warranty period, together with a copy of your purchase receipt, and an explanation of the suspected defect, PCI will replace in Canada the defective disk(s) or other media.

**Remedy** – PCI's entire liability, and your only remedy for any breach of this software media warranty is limited to replacement of the media only. It does not cover any other damages, including, but not limited to, loss of use or profit loss, or special, indirect or consequential damages, or other claims, whether or not of similar character.

**No Coverage** – This limited warranty does not apply if the disk(s) or other media has been used in other than a Panasonic product, or in environmental conditions other than those specified by PCI or the manufacturer, or if subjected to misuse, neglect, mishandling, modification or attempted modification of the program, or if damaged by accident or act of God. PCI is not responsible for damage to or loss of any program, data or removable storage media.

#### GENERAL

**NO OTHER WARRANTIES** – PCI DISCLAIMS ALL OTHER WARRANTIES, EITHER EXPRESS OR IMPLIED, INCLUDING, BUT NOT LIMITED TO, IMPLIED WARRANTIES OF MERCHANTABILITY AND FITNESS FOR A PARTICULAR PURPOSE, WITH RESPECT TO THE SOFTWARE, SOFTWARE MEDIA, COMPUTER PRODUCT, OPTIONS AND ACCESSORIES.

**NO LIABILITY FOR CONSEQUENTIAL DAMAGES** – IN NO EVENT SHALL PCI BE LIABLE FOR ANY SPECIAL, INDIRECT OR CONSEQUENTIAL DAMAGES ARISING FROM ANY BREACH OF THE LIMITED WARRANTIES SET OUT IN THIS DOCUMENT, OR FROM THE USE OF THE COMPUTER PRODUCT, INCLUDING, WITHOUT LIMITATION, LOSS OF DATA, BUSINESS, PROFIT OR GOODWILL.

IN ANY EVENT, PCI'S MAXIMUM LIABILITY FOR ANY BREACH SHALL NOT EXCEED THE AMOUNT ACTUALLY PAID BY YOU FOR THE COMPUTER PRODUCT.

NO ACTION, REGARDLESS OF ITS BASIS, MAY BE BEGUN AGAINST PCI MORE THAN TWO (2) YEARS AFTER THE CAUSE OF ACTION AROSE.

**Statutory Warranties** – Some jurisdictions do not allow these limitations or exclusions, so they may not apply to you.



As an ENERGY STAR® Partner, Matsushita Electric Industrial Co., Ltd. has determined that this product meets the ENERGY STAR® guidelines for energy efficiency.

**Outline of the International ENERGY STAR® Office Equipment Program**

The international ENERGY STAR® Office Equipment Program is an international program that promotes energy saving through the use of computers and other office equipment. The program backs the development and dissemination of products with functions that effectively reduce energy consumption. It is an open system in which business proprietors can participate voluntarily. The targeted products are office equipment such as computers, displays, printers, facsimiles, and copiers. Their standards and logos are uniform among participating nations.

---

**Panasonic Personal Computer Company,**  
50 Meadowlands Parkway, Panazip 2F-5,  
Secaucus, NJ 07094

**Panasonic Canada Inc.**  
5770 Ambler Drive Mississauga,  
Ontario L4W 2T3