

Thank you for purchasing this Philips Elegance 55 answering machine. With this user-friendly unit you can enjoy the advantage of quality performance in your communication lifestyle.

FEATURES OF YOUR ELEGANCE 55

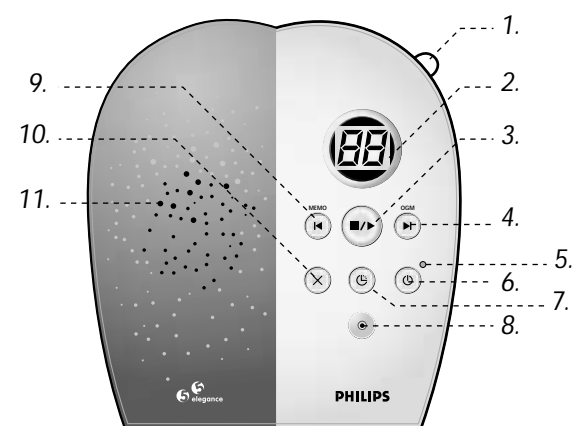

- | | |
|----------------------------|-----------------------|
| 1. Volume Slider | 7. Clock button |
| 2. Screen Display | 8. Microphone |
| 3. Play/Stop button | 9. Rewind/Memo button |
| 4. Forward/OGM button | 10. Erase button |
| 5. Answer On/Off Indicator | 11. Speaker |
| 6. On/Off button | |

Steps to install the battery:

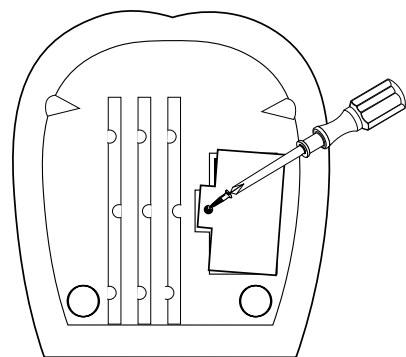

1. Turn your Elegance 55 over.
2. After locating the battery compartment, open the compartment cover by unscrewing the adjacent screw with a screwdriver.
3. Place a 9 Volt 6LR61 battery into the compartment by following the positive/negative polarity arrangement as indicated inside.
4. Replace the cover and screw in the screw until the cover is completely closed.

After installing the battery, plug in the telephone plug and power adaptor as shown in the diagram below.

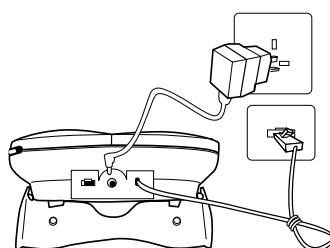

WHAT YOU SEE ON THE SCREEN DISPLAY AND ITS MEANING

- | | |
|---|--|
| "Lo" there is no battery, not installed properly, or battery low. | "ES" all messages are erased. |
| "CL" the clock is not set or it is not set properly. | "SA" all erased messages are restored. |
| "Fu" the memory is full; should erase some messages to allow message recording. | "OO" there is/are new memo(s). |
| "Sc" to change the remote control security code. | |

INSTALLING BATTERY INTO YOUR ELEGANCE 55

Important:

- It is strongly recommended that battery be installed. The battery acts as back up to prevent any loss of recorded messages when the main power supply fails.
- If there is no battery installed, not installed properly, or battery low, the Screen Display will show "Lo".
- Before opening the battery compartment, make sure that the telephone plug and power adaptor are disconnected from Elegance 55.

Table-top support

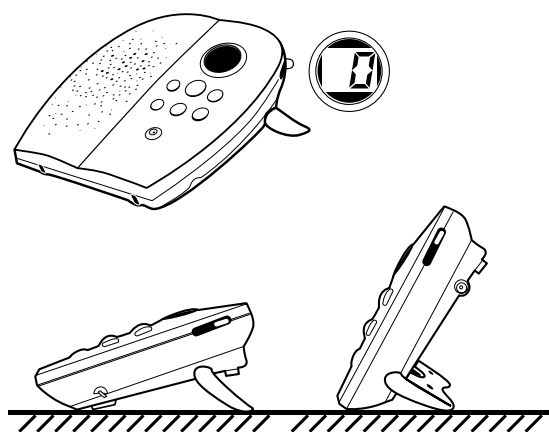

Wall Mounting

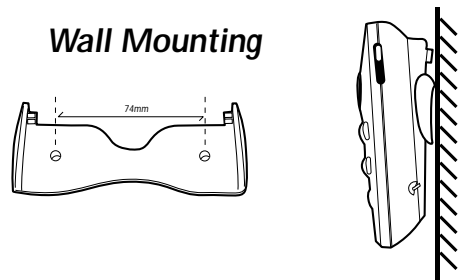

Results:

- The Screen Display will show a count from 1 to 15.
- A short beep will be heard.
- The Answer On/Off Indicator will light up.

Elegance 55 is now ready to answer calls for you.

SETTING THE CLOCK OF YOUR ELEGANCE 55

To listen to the clock settings, press once the CLOCK BUTTON (adjust the Volume Slider to your desirable volume level).

Reminder : If your clock is not set properly (day, hour and minute), the Screen Display will show "CL". Otherwise, "CL" will not be displayed.

Steps to set your clock's day, hour and minute :

If you want to stop the settings below, just press once the PLAY/STOP BUTTON. The clock will revert to its previous settings.

1. Press and hold the CLOCK BUTTON until a voice announces a day, then release the CLOCK BUTTON.
2. Press either the FORWARD or REWIND BUTTON to choose the day you wanted to set.
3. When the day you wanted to set is announced, press once the CLOCK BUTTON.
4. Continue to press either the FORWARD or REWIND BUTTON to choose the hour you wanted to set.
5. When the hour you wanted to set is announced, press once the CLOCK BUTTON.
6. Continue to press either the FORWARD or REWIND BUTTON to choose the minute you wanted to set.
7. When the minute you wanted to set is announced, press once the CLOCK BUTTON.

RECORDING YOUR OWN OUTGOING MESSAGE

Your Elegance 55 has a pre-recorded outgoing message: "Hello, we cannot take your call at the moment. Please leave your message after the tone." You can listen to this pre-recorded outgoing message by pressing once the OGM BUTTON. You can also listen to any recorded outgoing message by pressing once the OGM BUTTON.



Steps to record your own outgoing message:

1. Press and hold the OGM BUTTON until a long beep is heard, then release the OGM BUTTON.
 2. Record your own outgoing message towards the Microphone (at a distance between 5 to 8 centimetres). You have about 60 seconds to record.
 3. After you finish, press once the PLAY/STOP BUTTON.
- Result :** Your own outgoing message will be played automatically. If you want to stop it, just press once the PLAY/STOP BUTTON.

Steps to erase your own outgoing message and restore the pre-recorded one:

1. Press once the OGM BUTTON to play your own outgoing message.
 2. While your outgoing message is playing, press once the ERASE BUTTON.
- Result :** The pre-recorded outgoing message will be played automatically and your own is already erased from memory.

RECORDING YOUR MEMO MESSAGE



1. Press and hold the MEMO BUTTON until a long beep is heard, then release the MEMO BUTTON.
2. Record your memo message towards the Microphone (at a distance between 5 to 8 centimetres). You have about 60 seconds to record.
3. After you finish, press once the PLAY/STOP BUTTON.

Results :

- The Answer On/Off Indicator will flash.
- The Screen Display will show the total number of messages recorded.

2 WAYS TO LISTEN TO YOUR RECORDED MEMO MESSAGES

Adjust the Volume Slider to your desirable volume level.

- Press once the MEMO BUTTON. After listening, the Answer On/Off Indicator still will continue flashing.
- Press once the PLAY/STOP BUTTON. After listening, the Answer On/Off Indicator will stop flashing and light up steadily; the Screen Display will show the total number of messages recorded.

SELECTIVELY ERASING YOUR MEMO MESSAGES

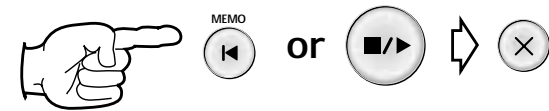

1. Press once either the MEMO or PLAY/STOP BUTTON to play your memo message.
2. While your memo message is playing, press once the ERASE BUTTON.

Result : The next memo message, if any, will be played automatically. Repeat step 2 if you also want to erase the memo message.

ERASING ALL YOUR MEMO MESSAGES

Reminder :

- This will also erase all your recorded messages. If you want to maintain some of your recorded messages, it is recommended that you selectively erase your memo messages.
- For the instructions to erase all your recorded messages, see ERASING ALL YOUR RECORDED MESSAGES in later sections.

TURNING YOUR ELEGANCE 55 ON/OFF

- If you want to turn on your machine and record messages, press once the ON/OFF BUTTON. The Answer On/Off Indicator will light up.
- If you want to turn off your machine and do not wish to record messages, press once the ON/OFF BUTTON again. The Answer On/Off Indicator will extinguish.

RECORDING THE INCOMING MESSAGES

Once your Elegance 55 is ON, it will pick up the incoming call after 4 rings if there is no new message in the machine, or 2 rings if there are new messages.

LISTENING TO YOUR MESSAGES

Notes :

- Adjust the Volume Slider to your desirable volume level.
- The Screen Display will show the message number that you are listening to.
- If you have set your clock, the voice will announce the day and time after each message received.

When listening to your new messages

Your Elegance 55 will inform you that you have new messages by a flashing Answer On/Off Indicator. To listen to your new messages, press once the PLAY/STOP BUTTON. If you want to stop listening, just press once again the same button.

Notes :

- If your memory have both old and new messages, pressing once the PLAY/STOP BUTTON will only play the new messages.
- After all new messages are played, the Answer On/Off Indicator will stop flashing, and the Screen Display will show the total number of recorded messages.

When listening to your old messages

- If you want to listen again to old messages, just press once the PLAY/STOP BUTTON. To stop listening, press once the same button again.
- You can also press once either the FORWARD or REWIND BUTTON if you want to skip or repeat the message.

WHAT HAPPEN WHEN MEMORY IS FULL?

- The Screen Display will show “Fu”.
- When your phone rings, Elegance 55 will answer “Memory full, please call later.”
- The outgoing message will not play and the machine will not record any messages.

Reminder : It is time for you to erase some of your recorded messages. Follow the sections below.

SELECTIVELY ERASING YOUR RECORDED MESSAGES



1. Press once the PLAY/STOP BUTTON to play your recorded messages.
2. While your message is playing, press once the ERASE BUTTON .

Result : The next message, if any, will be played automatically. Repeat step 2 if you also want to erase the message.



ERASING ALL YOUR RECORDED MESSAGES

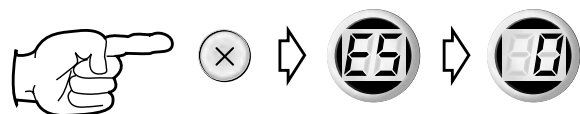

Press and hold the ERASE BUTTON until a long beep is heard, then release the ERASE BUTTON . The Screen Display will show “ES”, followed by “0”, which means no messages.

RESTORING ALL ERASED MESSAGES

Notes :

- This can only apply to **all** erased messages and not to selectively erased messages.
- Erased messages can only be restored provided that no new message is recorded immediately after the erase.

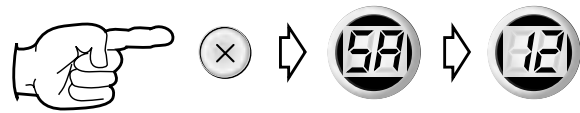

Press and hold the ERASE BUTTON until a long beep is heard, then release the ERASE BUTTON . The Screen Display will show “SA”, followed by the pre-erased total number of recorded messages.



CHANGING YOUR REMOTE CONTROL SECURITY CODE

Your Elegance 55 comes with a factory default security code of 159, which can be changed to any 3-digit combination ranging from 000 to 999. This security code is for your use to remotely access and control your answering machine from another phone.

Note : You can stop changing the security code anytime by pressing once the PLAY/STOP BUTTON . It will restore to its previous setting.

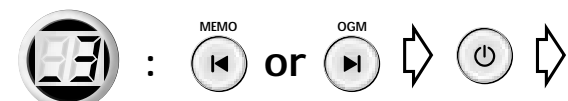
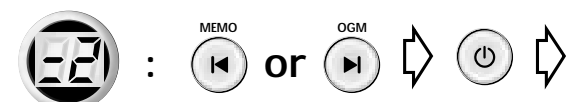
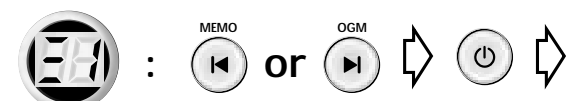

1. Press and hold the ON/OFF BUTTON until a long beep is heard. The Screen Display will show “Sc”.
2. Release the ON/OFF BUTTON . The Screen Display will show the previous security code in sequence, then will stop at the first digit of the security code for you to change.
3. Press either the FORWARD or REWIND BUTTON to choose the first digit for your new security code. Press once the ON/OFF BUTTON to confirm your choice. The Screen Display will automatically show the second digit of the security code.
4. Press either the FORWARD or REWIND BUTTON to choose the second digit for your new security code. Press once the ON/OFF BUTTON to confirm your choice. The Screen Display will automatically show the last digit of the security code.
5. Press either the FORWARD or REWIND BUTTON to choose the last digit for your new security code. Press once the ON/OFF BUTTON to confirm your choice.

Note : If Elegance 55 has no battery installed or has battery low status, occurrence of power failure will result to all the recorded messages and your changed remote control security code to be lost from memory. In this case, the factory default security code of 159 will be restored automatically after resumption of power supply.

Reminder : For the instructions to remotely access and control your Elegance 55 from another phone, please refer to the Remote Control Reference Card enclosed.



SAFETY INFORMATION

The only way to cut off the power supply to the telephone / answering machine is to disconnect the power supply block from the mains outlet. Be sure that the mains outlet is located near the telephone device and is easily accessible.

The CE mark on the product certifies its compliance with all applicable technical regulations, as of the date of authorization, concerning user safety and electromagnetic interference according to directives 73/23/EEC, 89/336/EEC and 93/68/EEC.

Always follow basic safety precautions when using this product to reduce the risk of injury, fire, or electric shock.

1. Read and understand all instructions in the user’s manual. Observe all markings in the product.
2. During thunderstorms, avoid using telephones except cordless models. There may be a slight chance of electric shock from lightning.
3. Do not use a telephone in the vicinity of a gas leak. If you suspect a gas leak, report it immediately, but use a telephone away from the area where gas is leaking. If this product is a cordless model, make sure the base is also away from the area.
4. Do not use this product near water, or when you are wet. For example, do not use it in a wet basement or shower, or next to a swimming pool, bathtub, kitchen sink, or laundry tub. Do not use liquids or aerosol sprays for cleaning. If the product comes in contact with any liquids, unplug any line or power cord immediately. Do not plug the product back in until it has dried thoroughly.



5. Install this product in a protected location where no one can trip over any line or power cord. Protect cords from damage or abrasion.
6. If this product does not operate normally, read the instruction in the user’s manual. Do not open this product! Opening the product or reassembling it incorrectly may expose you to hazardous voltages or other risks.
7. If this product has user replaceable batteries, replace batteries only as described in your user’s manual. Do not burn or puncture batteries – they contain caustic chemicals.
8. If this product has a three-prong (grounding) plug or a polarized plug with one wide prong, it may not fit in non-polarized outlets. Do not defect the purpose of these plugs. If they do not fit in your outlet, the outlet should be replaced by an electrician.
CAUTION: Use only the power adapter provided with this product. To obtain a replacement, call Philips Consumer Communications.

ELECTRICAL CONNECTION:

Mains power supply 220-240 volts, single-phase AC, except for installations with the IT diagram as defined in standard EN 60-950. Important! The voltage of the network is classified as hazardous according to the criteria of standard EN 60-950.

TELEPHONE CONNECTION:

The voltages used on this network are classified as TRT-3 (telecommunications network voltage as defined in standard EN 60-950).



CONNECTION INSTRUCTIONS:

The answering machine, Philips Elegance 55 (TD9368), is designed for connection to the analogue public switched telephone network (PSTN) only.

CONNECTION CONFIGURATION:

The answering machine, Philips Elegance 55 (TD9368), can be used as a single device and/or as part of a configuration with other pre- or post- connected type-approved terminal equipment.

NEW INSTALLATION OR REPLACEMENT OF THE BATTERY:

CAUTION: Disconnect the telephone line plug from the wall socket before opening the battery compartment door. Unscrew the compartment door and connect a new 9 volts battery to the polarized battery tap. Replace and fasten the battery compartment door before reconnecting the telephone line plug. Do not install or replace any telephone device during thunderstorms!

RINGER EQUIVALENC NUMBER (REN):

Your Elegance 55 (TD9368) has a Ringer Equivalence Number (REN) of 1.0. To determine the maximum number of telephones that can be connected to your line, add together the individual RENs of the apparatus you wish to connect. If this total exceeds four, one or all of your telephones may not ring correctly.



This product may be used legally in the country where the appropriate authority has given its specific authorization. This authorization appears on a label on the base station.

In the interest of improving our products and services, Philips reserves the right to alter the specifications without prior notice.

UK

Your international guarantee

Dear Customer,

Thank you for purchasing this Philips product which has been designed and manufactured to the highest quality standards. If, unfortunately, something should go wrong with this product Philips guarantees free of charge labour and replacement parts irrespective of the country where it is repaired during a period of 12 months from date of purchase. This international Philips guarantee complements the existing national guarantee obligations to you of dealers and Philips in the country of purchase and does not affect your statutory rights as a customer.

The Philips guarantee applies provided the product is handled properly for its intended use, in accordance with its operating instructions and upon presentation of the original invoice or cash receipt, indicating the date of purchase, dealer’s name and model and production number of the product.

The Philips guarantee may not apply if :

- the documents have been altered in any way or made illegible ;
- the model or production number on the product has been altered, deleted, removed or made illegible ;
- repairs or product modifications and alterations have been executed by unauthorised service organisations or persons ;
- damage is caused by accidents including but not limited to lightning, water or fire, misuse or neglect.

Please note that the product is not defective under this guarantee in the case where modifications become necessary in order for the product to comply with local or national technical standards which apply in countries for which the product was not originally designed and/or manufactured. Therefore always check whether a product can be used in a specific country.

In the event you require service whilst in another country a dealer address can be given to you by the Philips Consumer Help Desk in that country.

In order to avoid unnecessary inconvenience, we advise you to read the operating instructions carefully before contacting your dealer. In case your Philips product is not working correctly or is defective, please contact:

PHILIPS CONSUMER COMMUNICATIONS
PO BOX 1056
Kingston & Surbiton
Surrey
KT1 6YN
Phone : 0645 282828



PHILIPS

55 eleg. (UK) P. 2 C – V3